

Panasonic®

Model No.

TH-42LF20U

TH-47LF20U

Operating Instructions

FULL HD LCD Display



English

Before connecting, operating or adjusting this product,
please read these instructions completely.
Please keep this manual for future reference.

HDMI

	CAUTION RISK OF ELECTRIC SHOCK DO NOT OPEN	
WARNING: To reduce the risk of electric shock, do not remove cover or back. No user-serviceable parts inside. Refer servicing to qualified service personnel.		



The lightning flash with arrow-head within a triangle is intended to tell the user that parts inside the product are a risk of electric shock to persons.



The exclamation point within a triangle is intended to tell the user that important operating and servicing instructions are in the papers with the appliance.

WARNING : To prevent damage which may result in fire or shock hazard, do not expose this apparatus to rain or moisture.
Do not place containers with water (flower vase, cups, cosmetics, etc.) above the set.
(including on shelves above, etc.)

WARNING : 1) To prevent electric shock, do not remove cover. No user serviceable parts inside. Refer servicing to qualified service personnel.
2) Do not remove the grounding pin on the power plug. This apparatus is equipped with a three pin grounding-type power plug. This plug will only fit a grounding-type power outlet. This is a safety feature. If you are unable to insert the plug into the outlet, contact an electrician.
Do not defeat the purpose of the grounding plug.



As an ENERGY STAR® Partner, Panasonic has determined that this product meets the ENERGY STAR® guidelines for energy efficiency.

Important Safety Instructions

- 1) Read these instructions.
- 2) Keep these instructions.
- 3) Heed all warnings.
- 4) Follow all instructions.
- 5) Do not use this apparatus near water.
- 6) Clean only with dry cloth.
- 7) Do not block any ventilation openings. Install in accordance with the manufacturer's instructions.
- 8) Do not install near any heat sources such as radiators, heat registers, stoves, or other apparatus (including amplifiers) that produce heat.
- 9) Do not defeat the safety purpose of the polarized or grounding-type plug. A polarized plug has two blades with one wider than the other. A grounding type plug has two blades and a third grounding prong. The wide blade or the third prong are provided for your safety. If the provided plug does not fit into your outlet, consult an electrician for replacement of the obsolete outlet.
- 10) Protect the power cord from being walked on or pinched particularly at plugs, convenience receptacles, and the point where they exit from the apparatus.
- 11) Only use attachments / accessories specified by the manufacturer.
- 12) Use only with the cart, stand, tripod, bracket, or table specified by the manufacturer, or sold with the apparatus. When a cart is used, use caution when moving the cart / apparatus combination to avoid injury from tip-over.
- 13) Unplug this apparatus during lightning storms or when unused for long periods of time.
- 14) Refer all servicing to qualified service personnel. Servicing is required when the apparatus has been damaged in any way, such as power-supply cord or plug is damaged, liquid has been spilled or objects have fallen into the apparatus, the apparatus has been exposed to rain or moisture, does not operate normally, or has been dropped.
- 15) To prevent electric shock, ensure the grounding pin on the AC cord power plug is securely connected.



Dear Panasonic Customer

Welcome to the Panasonic family of customers. We hope that you will have many years of enjoyment from your new LCD Display.

To obtain maximum benefit from your set, please read these Instructions before making any adjustments, and retain them for future reference.

Retain your purchase receipt as well, and record the model number and serial number of your set in the space provided on the rear cover of these instructions.

Visit our Panasonic Web Site <http://panasonic.net>

Table of Contents

Important Safety Instructions	3	SCREENSAVER (For preventing image retention)	30
FCC STATEMENT	5	Setup of SCREENSAVER Time	31
Safety Precautions	6	WOBBLING	31
Maintenance	7	Reduces power consumption	32
Accessories	8	Customizing the Input labels	33
Accessories Supplied	8	Selecting the On-Screen Menu Language	34
Remote Control Batteries	8	Customizing the On-Screen Menu Display	34
Connections	9	SET UP for MULTI DISPLAY	35
AC cord connection and fixing, cable fixing.....	9	How to setup MULTI DISPLAY	35
Video equipment connection	9	SET UP for Input Signals	37
VIDEO and COMPONENT / RGB IN connection	10	COMPONENT / RGB IN SELECT	37
HDMI connection	11	SIGNAL menu	38
DVI-D IN connection.....	11	3D Y/C FILTER.....	38
PC Input Terminals connection.....	12	COLOR SYSTEM.....	39
SERIAL Terminals connection	13	3:2 PULLDOWN	39
Power ON / OFF	14	XGA MODE	39
Selecting the input signal	16	NOISE REDUCTION	40
Basic Controls	17	SYNC	40
ASPECT Controls	19	Input signal display	41
Digital Zoom	20	Options Adjustments	42
On-Screen Menu Displays	21	Troubleshooting	44
Adjusting POS. /SIZE	23	Applicable input signals	45
PICTURE Adjustments	25	Shipping condition	46
ADVANCED SETTINGS.....	26	Specifications	47
SOUND Adjustment	27		
PRESENT TIME SETUP / SET UP TIMER	28		
PRESENT TIME SETUP	28		
SET UP TIMER	29		

FCC STATEMENT

This equipment has been tested and found to comply with the limits for a Class B digital device, pursuant to Part 15 of the FCC Rules. These limits are designed to provide reasonable protection against harmful interference in a residential installation. This equipment generates, uses and can radiate radio frequency energy and, if not installed and used in accordance with the instructions, may cause harmful interference to radio communications. However, there is no guarantee that interference will not occur in a particular installation. If this equipment does cause harmful interference to radio or television reception, which can be determined by turning the equipment off and on, the user is encouraged to try to correct the interference by one or more of the following measures:

- Reorient or relocate the receiving antenna.
- Increase the separation between the equipment and receiver.
- Connect the equipment into an outlet on a circuit different from that to which the receiver is connected.
- Consult the dealer or an experienced technician for help.

This device complies with Part 15 of the FCC Rules. Operation is subject to the following two conditions: (1) This device may not cause harmful interference, and (2) this device must accept any interference received, including interference that may cause undesired operation.

FCC CAUTION:

To assure continued compliance, follow the attached installation instructions and use only shielded interface cables when connecting to computer or peripheral devices. Any changes or modifications not expressly approved by Panasonic Corp. of North America could void the user's authority to operate this device.

FCC Declaration of Conformity

Model No. TH-42LF20U, TH-47LF20U

Responsible Party:	Panasonic Corporation of North America Three Panasonic Way 2F-5, Secaucus, NJ 07094
Contact Source:	Panasonic Solutions Company Panasonic Plasma Concierge 1-800-973-4390

CANADIAN NOTICE:

This Class B digital apparatus complies with Canadian ICES-003.

Note:

Image retention may occur. If you display a still picture for an extended period, the image might remain on the screen. However, it will disappear after a while.

Trademark Credits

- VGA is a trademark of International Business Machines Corporation.
- Macintosh is a registered trademark of Apple Inc., USA.
- SVGA, XGA, SXGA and UXGA are registered trademarks of the Video Electronics Standard Association.
Even if no special notation has been made of company or product trademarks, these trademarks have been fully respected.
- HDMI, the HDMI Logo, and High-Definition Multimedia Interface are trademarks or registered trademarks of HDMI Licensing LLC in the United States and other countries.

Safety Precautions



CAUTION

This LCD Display is for use only with the following optional accessories. Use with any other type of optional accessories may cause instability which could result in the possibility of injury.

(All of the following accessories are manufactured by Panasonic Corporation.)

- Pedestal TY-STLF20

Always be sure to ask a qualified technician to carry out set-up.

Small parts can present choking hazard if accidentally swallowed. Keep small parts away from young children. Discard unneeded small parts and other objects, including packaging materials and plastic bags/sheets to prevent them from being played with by young children, creating the potential risk of suffocation.

■ When using the LCD Display

Do not bring your hands, face or objects close to the ventilation holes of the Display.

- Top of the Display is usually very hot due to the high temperature of exhaust air being released through the ventilation holes. Burns or personal injuries can happen if any body parts are brought too close. Placing any object near the top of the display could also result in heat damages to the object as well as to the Display if its ventilation holes are blocked.

Be sure to disconnect all cables before moving the Display.

- Moving the Display with its cables attached might damage the cables which, in turn, can cause fire or electric shock.

Disconnect the power plug from the wall outlet as a safety precaution before carrying out any cleaning.

- Electric shocks can result if this is not done.

Clean the power cable regularly to prevent it from becoming dusty.

- Built-up dust on the power cord plug can increase humidity which might damage the insulation and cause fire. Unplug the cord from the wall outlet and clean it with a dry cloth.

Note:

Image retention may occur. If you display a still picture for an extended period, the image might remain on the screen. However, it will disappear after a while.

WARNING

■ Setup

Do not place the Display on sloped or unstable surfaces.

- The Display may fall off or tip over.

Do not place any objects on top of the Display.

- If water spills onto the Display or foreign objects get inside it, a short-circuit may occur which could result in fire or electric shock. If any foreign objects get inside the Display, please consult an Authorized Service Center.

Do not cover the ventilation holes.

- Doing so may cause the Display to overheat, which can cause fire or damage to the Display.

Transport only in upright position!

- Transporting the unit with its display panel facing upright or downward may cause damage to the internal circuitry.

For sufficient ventilation;

Leave a space of 3 15/16" (10 cm) or more at the top, left and right, and 1 31/32" (5 cm) or more at the rear, and also keep the space between the bottom of the display and the floor surface.

Cautions for Wall Installation

- Wall installation should be performed by an installation professional. Installing the Display incorrectly may lead to an accident that results in death or serious injury. Furthermore, when installing on a wall, a UL standard certified wall hanging bracket (VESA 400 × 400) must be used.
- When installing the Display vertically, be sure to install the power switch onto the bottom of the Display.

An apparatus with CLASS I construction shall be connected to a mains socket outlet with a protective earthing connection.

■ AC Power Supply Cord

The Display is designed to operate on 110 - 127 V AC, 50/60 Hz.

Ensure that the mains plug is easily accessible.

Do not use any power supply cord other than that provided with this unit.

- Doing so may cause fire or electric shocks.

Securely insert the power cord plug as far as it will go.

- If the plug is not fully inserted, heat may be generated which could cause fire. If the plug is damaged or the wall socket plate is loose, they should not be used.

Do not handle the power cord plug with wet hands.

- Doing so may cause electric shocks.

Do not do anything that might damage the power cable. When disconnecting the power cable, hold the plug, not the cable.

- Do not make any modifications, place heavy objects on, place near hot objects, heat, bend, twist or forcefully pull the power cable. Doing so may cause damage to the power cable which can cause fire or electric shock. If damage to the cable is suspected, have it repaired at an Authorized Service Center.

If the Display will not be used for a long period of time, unplug the power cord from the wall outlet.

■ If problems occur during use

If a problem occurs (such as no picture or no sound), or if smoke or an abnormal odor is detected from the Display, unplug the power cord immediately.

- Continuous use of the Display under these conditions might cause fire or permanent damage to the unit. Have the Display evaluated at an Authorized Service Center. Services to the Display by any unauthorized personnel are strongly discouraged due to its high voltage dangerous nature.

If water or foreign objects get inside the Display, if the Display is dropped, or if the cabinet becomes damaged, disconnect the power cord plug immediately.

- A short may occur, which could cause fire. Contact an Authorized Service Center for any repairs that need to be made.

Maintenance

The front of the display panel has been specially treated. Wipe the panel surface gently using only a cleaning cloth or a soft, lint-free cloth.

- If the surface is particularly dirty, wipe with a soft, lint-free cloth which has been soaked in pure water or water in which neutral detergent has been diluted 100 times, and then wipe it evenly with a dry cloth of the same type until the surface is dry.
- Do not scratch or hit the surface of the panel with fingernails or other hard objects, otherwise the surface may become damaged. Furthermore, avoid contact with volatile substances such as insect sprays, solvents and thinner, otherwise the quality of the surface may be adversely affected.

If the cabinet becomes dirty, wipe it with a soft, dry cloth.

- If the cabinet is particularly dirty, soak the cloth in water to which a small amount of neutral detergent has been added and then wring the cloth dry. Use this cloth to wipe the cabinet, and then wipe it dry with a dry cloth.
- Do not allow any detergent to come into direct contact with the surface of the Display. If water droplets get inside the unit, operating problems may result.
- Avoid contact with volatile substances such as insect sprays, solvents and thinner, otherwise the quality of the cabinet surface may be adversely affected or the coating may peel off. Furthermore, do not leave it for long periods in contact with articles made from rubber or PVC.

Accessories

Accessories Supplied

Check that you have the Accessories and items shown



Operating Instruction book

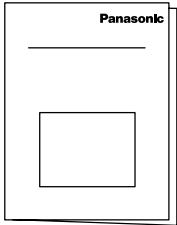

CD-ROM (Operating instructions)

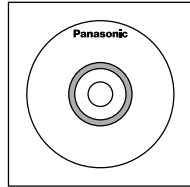

Remote Control Transmitter N2QAYB000535

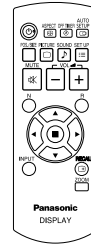

Batteries for the Remote Control Transmitter (AA Size × 2)

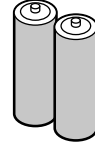

AC cord

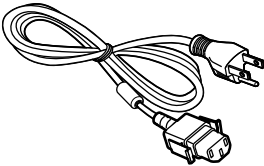

Remote Control Batteries

Requires two AA batteries.

1. Pull and hold the hook, then open the battery cover.

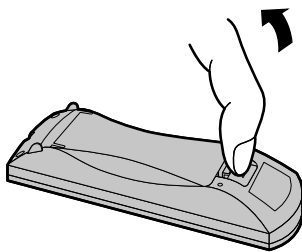

2. Insert batteries - note correct polarity (+ and -).

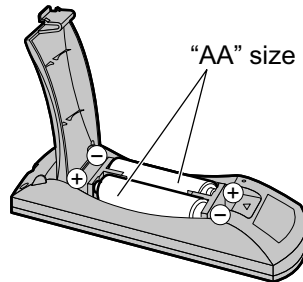

3. Replace the cover.

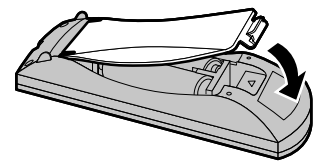

Helpful Hint:

For frequent remote control users, replace old batteries with Alkaline batteries for longer life.

⚠ Precaution on battery use

Incorrect installation can cause battery leakage and corrosion that will damage the remote control transmitter. Disposal of batteries should be in an environment-friendly manner.

Observe the following precautions:

1. Batteries should always be replaced as a pair. Always use new batteries when replacing the old set.
2. Do not combine a used battery with a new one.
3. Do not mix battery types (example: "Zinc Carbon" with "Alkaline").
4. Do not attempt to charge, short-circuit, disassemble, heat or burn used batteries.
5. Battery replacement is necessary when the remote control acts sporadically or stops operating the Display.
6. Do not burn or breakup batteries.

Batteries must not be exposed to excessive heat such as sunshine, fire or the like.

Connections

AC cord connection and fixing, cable fixing

AC cord fixing

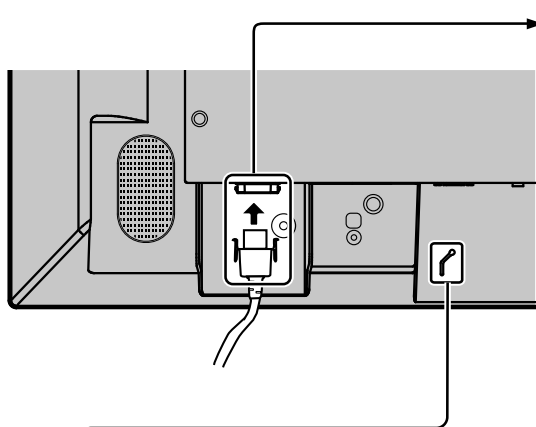

Plug the AC cord into the display unit.
Plug the AC cord until it clicks.

Note:
Make sure that the AC cord is locked on both the left and right sides.

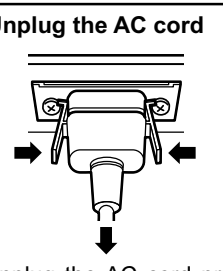

Unplug the AC cord

Unplug the AC cord pressing the two knobs.

Note:
When disconnecting the AC cord, be absolutely sure to disconnect the AC cord plug at the socket outlet first.

Cable fixing

Fix the cable in place using the bead band attached to the display.

1 Remove the bead band

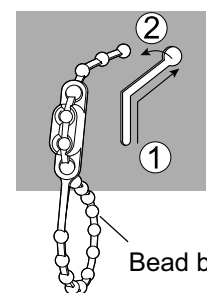

Bead band

2 Bundle the cables

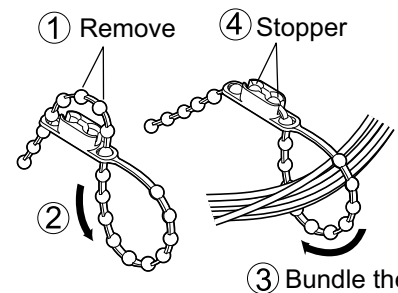

① Remove ④ Stopper
② ③ Bundle the cables

3 Attach the bead band

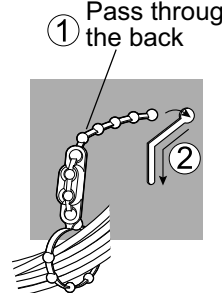

① Pass through to the back
②

Video equipment connection

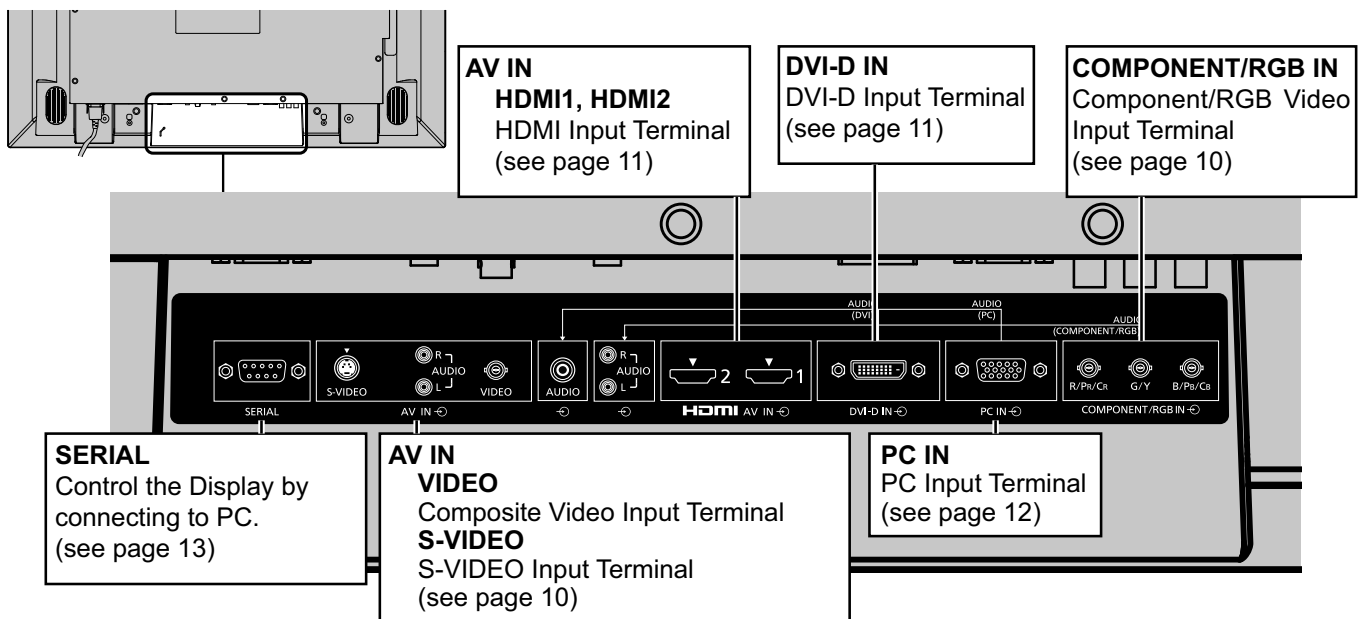

AV IN
HDMI1, HDMI2
HDMI Input Terminal
(see page 11)

DVI-D IN
DVI-D Input Terminal
(see page 11)

COMPONENT/RGB IN
Component/RGB Video
Input Terminal
(see page 10)

SERIAL
Control the Display by
connecting to PC.
(see page 13)

AV IN
VIDEO
Composite Video Input Terminal
S-VIDEO
S-VIDEO Input Terminal
(see page 10)

PC IN
PC Input Terminal
(see page 12)

Connections

VIDEO and COMPONENT / RGB IN connection

Note:

Additional equipment, cables and adapter plugs shown are not supplied with this set.

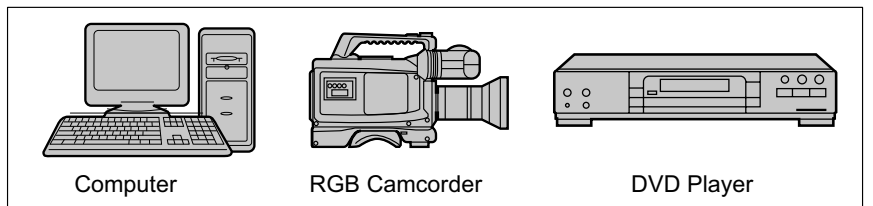
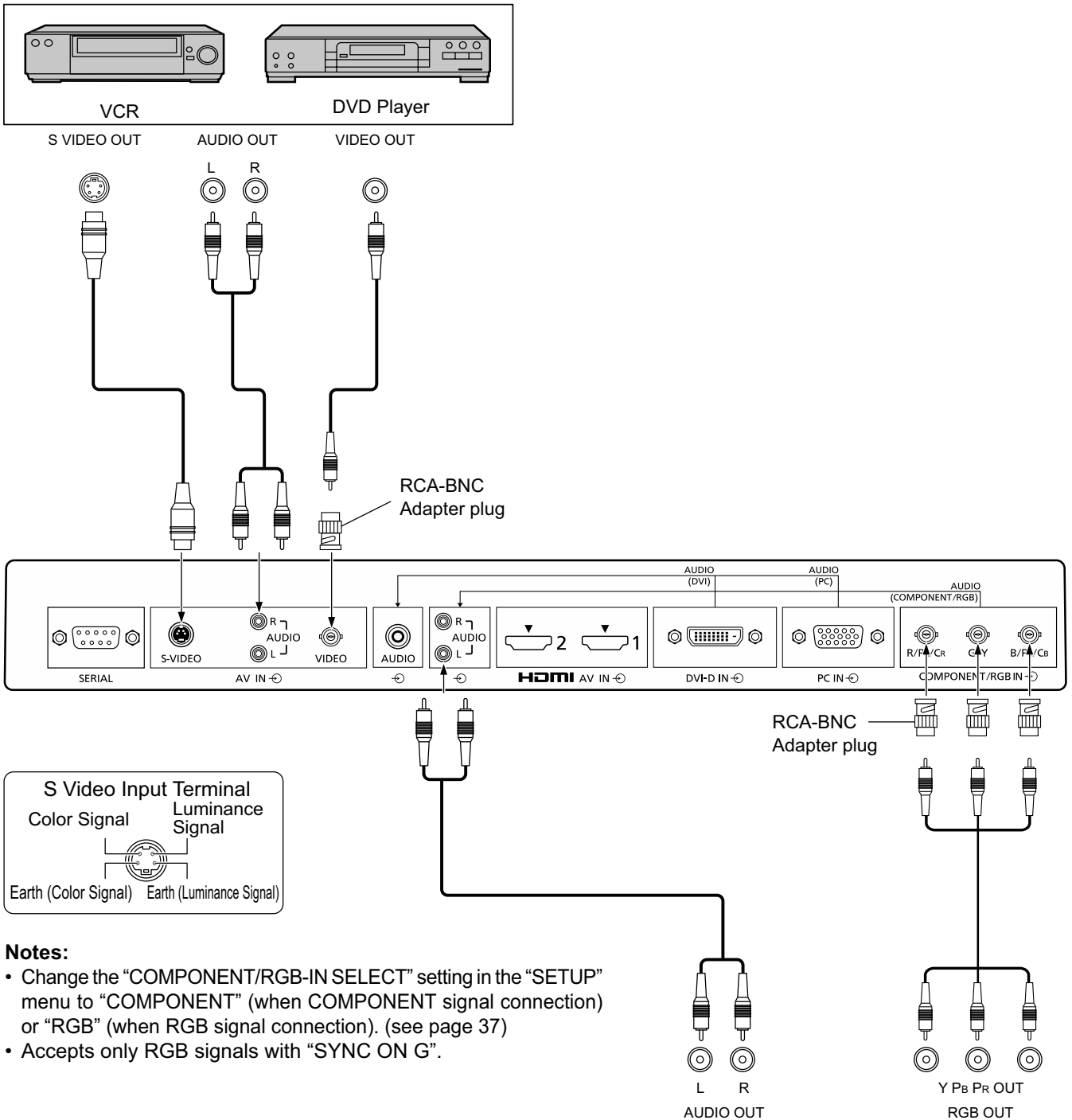

HDMI connection

[Pin assignments and signal names]

Pin No.	Signal Name	Pin No.	Signal Name
①	T.M.D.S Data2+	⑪	T.M.D.S Clock Shield
②	T.M.D.S Data2 Shield	⑫	T.M.D.S Clock-
③	T.M.D.S Data2-	⑬	CEC
④	T.M.D.S Data1+	⑭	Reserved (N.C. on device)
⑤	T.M.D.S Data1 Shield		
⑥	T.M.D.S Data1-	⑮	SCL
⑦	T.M.D.S Data0+	⑯	SDA
⑧	T.M.D.S Data0 Shield	⑰	DDC/CEC Ground
⑨	T.M.D.S Data0-	⑱	+5V Power
⑩	T.M.D.S Clock+	⑲	Hot Plug Detect

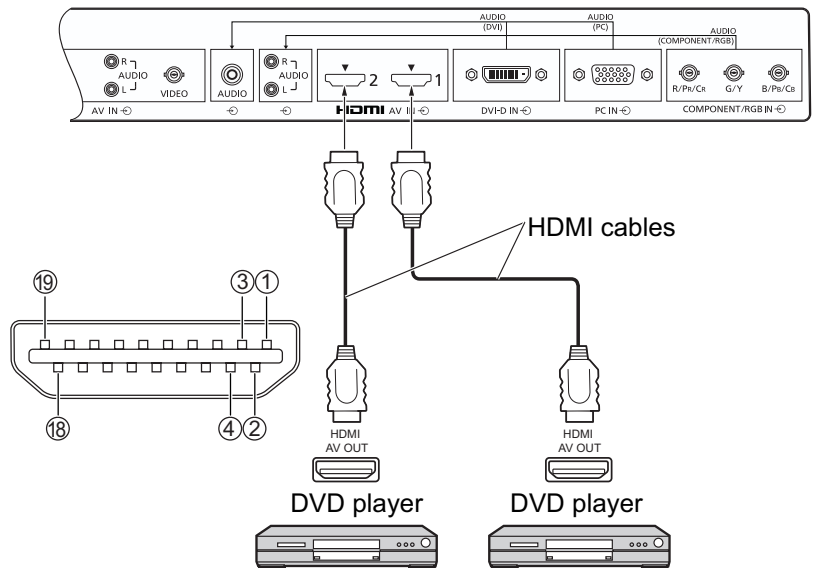

Note:

Additional equipment and HDMI cable shown are not supplied with this set.

DVI-D IN connection



DVI-D Input Connector Pin Layouts

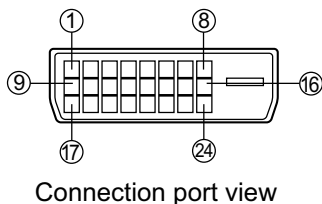

Pin No.	Signal Name	Pin No.	Signal Name
①	T.M.D.S. data 2-	⑬	
②	T.M.D.S. data 2+	⑭	+5 V DC
③	T.M.D.S. data 2 shield	⑮	Ground
④		⑯	Hot plug detect
⑤		⑰	T.M.D.S. data 0-
⑥	DDC clock	⑱	T.M.D.S. data 0+
⑦	DDC data	⑲	T.M.D.S. data 0 shield
⑧		⑳	
⑨	T.M.D.S. data 1-	㉑	
⑩	T.M.D.S. data 1+	㉒	T.M.D.S. clock shield
⑪	T.M.D.S. data 1 shield	㉓	T.M.D.S. clock+
⑫		㉔	T.M.D.S. clock-

Notes:

- Additional equipment and cables shown are not supplied with this set.
- Use the DVI-D cable with Ferrite core complying with the DVI standard. Image deterioration may occur depending on the length or the quality of the cable.

Connections

PC Input Terminals connection

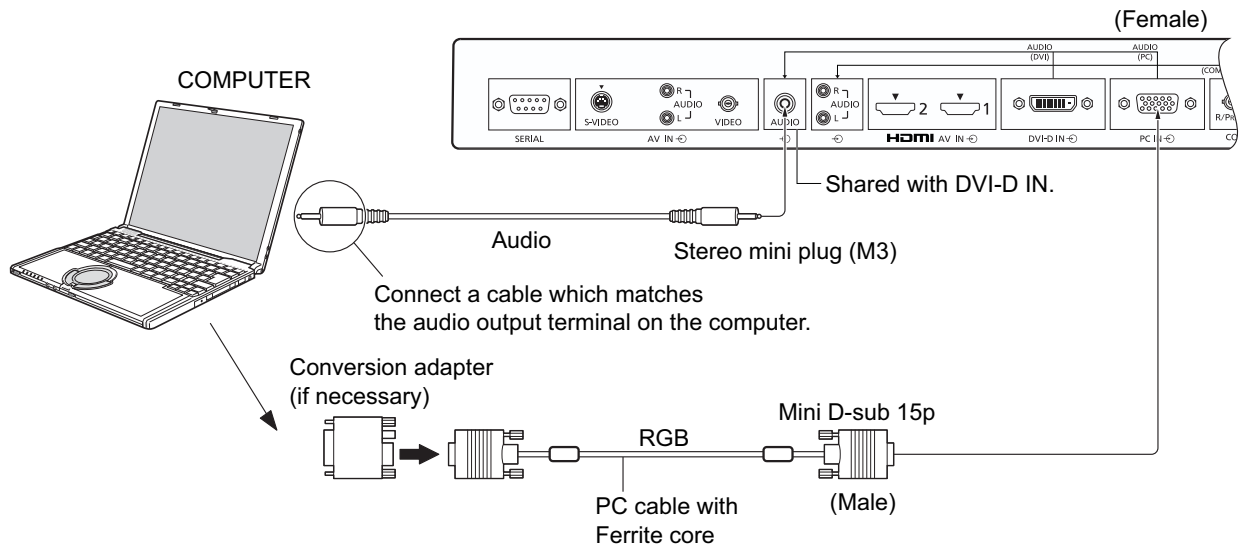

Notes:

- Computer signals which can be input are those with a horizontal scanning frequency of 30 to 110 kHz and vertical scanning frequency of 48 to 120 Hz. (However, the image will not be displayed properly if the signals exceed 1,200 lines.)
- The display resolution is a maximum of 1,440 × 1,080 dots when the aspect mode is set to "4:3", and 1,920 × 1,080 dots when the aspect mode is set to "FULL". If the display resolution exceeds these maximums, it may not be possible to show fine detail with sufficient clarity.
- The PC input terminals are DDC2B-compatible. If the computer being connected is not DDC2B-compatible, you will need to make setting changes to the computer at the time of connection.
- Some PC models cannot be connected to the set.
- There is no need to use an adapter for computers with DOS/V compatible Mini D-sub 15P terminal.
- The computer shown in the illustration is for example purposes only.
- Additional equipment and cables shown are not supplied with this set.
- Panasonic recommends using a PC cable that includes a Ferrite core.
- Do not set the horizontal and vertical scanning frequencies for PC signals which are above or below the specified frequency range.

Signal Names for Mini D-sub 15P Connector

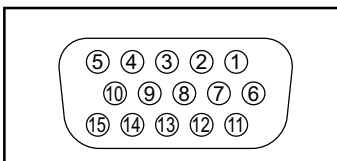

Pin Layout for PC Input Terminal

Pin No.	Signal Name	Pin No.	Signal Name	Pin No.	Signal Name
①	R	⑥	GND (Ground)	⑪	NC (not connected)
②	G	⑦	GND (Ground)	⑫	SDA
③	B	⑧	GND (Ground)	⑬	HD/SYNC
④	NC (not connected)	⑨	+5 V DC	⑭	VD
⑤	GND (Ground)	⑩	GND (Ground)	⑮	SCL

SERIAL Terminals connection

The SERIAL terminal is used when the Display is controlled by a computer.

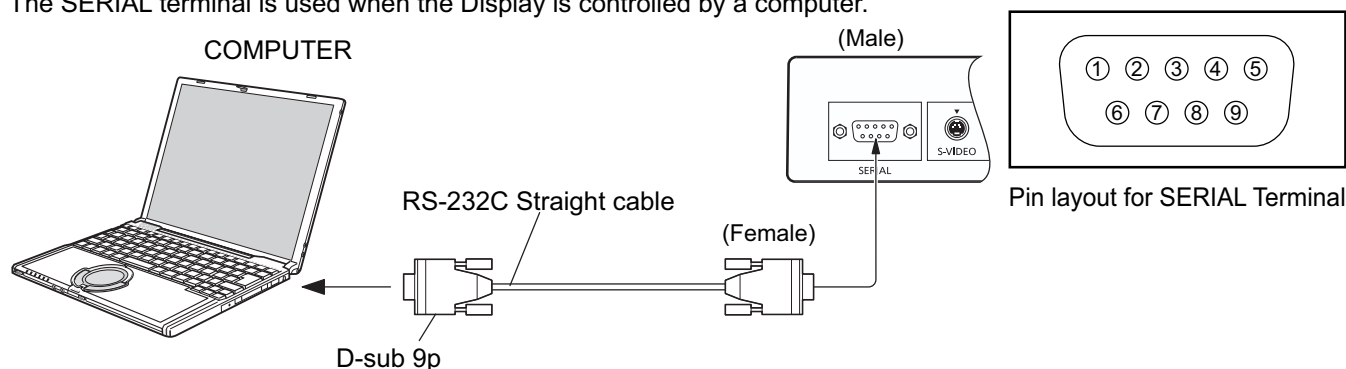

Notes:

- Use the RS-232C straight cable to connect the computer to the Display.
- The computer shown is for example purposes only.
- Additional equipment and cables shown are not supplied with this set.

The SERIAL terminal conforms to the RS-232C interface specification, so that the Display can be controlled by a computer which is connected to this terminal.

The computer will require software which allows the sending and receiving of control data which satisfies the conditions given below. Use a computer application such as programming language software. Refer to the documentation for the computer application for details.

Signal names for D-sub 9P connector

Pin No.	Details
②	R X D
③	T X D
⑤	GND
④ • ⑥	Non use
⑦ ⑧	(Shorted in this set)
① • ⑨	NC

These signal names are those of computer specifications.

Communication parameters

Signal level	RS-232C compliant
Synchronization method	Asynchronous
Baud rate	9600 bps
Parity	None
Character length	8 bits
Stop bit	1 bit
Flow control	-

Basic format for control data

The transmission of control data from the computer starts with a STX signal, followed by the command, the parameters, and lastly an ETX signal in that order. If there are no parameters, then the parameter signal does not need to be sent.

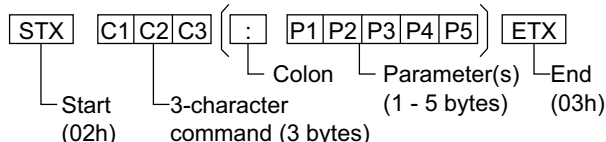

Notes:

- If multiple commands are transmitted, be sure to wait for the response for the first command to come from this unit before sending the next command.
- If an incorrect command is sent by mistake, this unit will send an “ER401” command back to the computer.

Command

Command	Parameter	Control details
PON	None	Power ON
POF	None	Power OFF
AVL	**	Volume 000 - 100
AMT	0	Audio MUTE OFF
	1	Audio MUTE ON
IMS	None	Input select (toggle)
	AV1	VIDEO input (VIDEO)
	AV2	COMPONENT/RGB IN input (Component)
	HM1	HDMI1 input (HDMI1)
	HM2	HDMI2 input (HDMI2)
DAM	DV1	DVI-D IN input (DVI)
	PC1	PC IN input (PC)
	None	Screen mode select (toggle)
DAM	ZOOM	ZOOM1
	FULL	FULL
	NORM	4:3
	ZOM2	ZOOM2

With the power off, this display responds to PON command only.

Power ON / OFF

Connecting the AC cord plug to the Display.

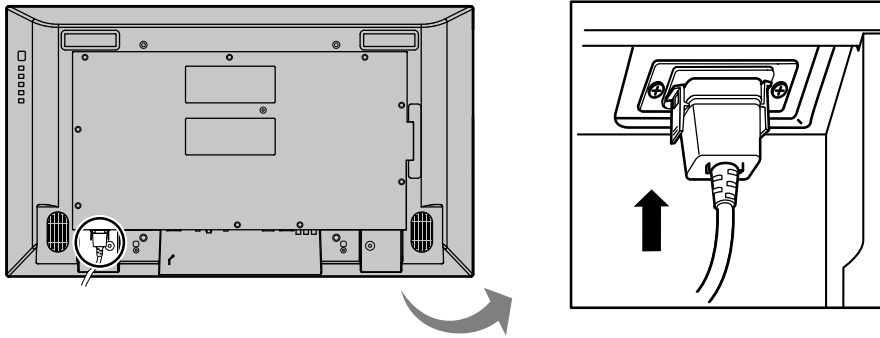

Connecting the plug to the Wall Outlet.

Note:

When disconnecting the AC cord, be absolutely sure to disconnect the AC cord plug at the socket outlet first.

Press the Power switch on the Display to turn the set on: Power-On.

Power Indicator: Green

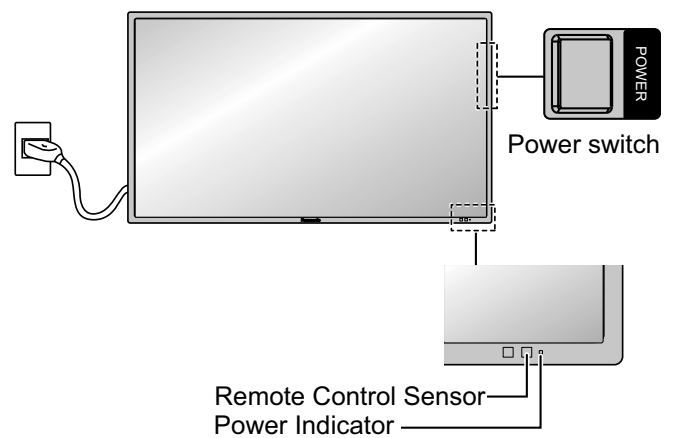

Press the  button on the remote control to turn the Display off.

Power Indicator: Red (standby)

Press the  button on the remote control to turn the Display on.

Power Indicator: Green

Turn the power to the Display off by pressing the POWER switch on the unit, when the Display is on or in standby mode.

Note:

During operation of the power management function, the power indicator turns orange in the power off state.

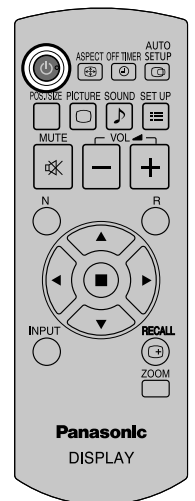

When first switching on the unit

Following screen will be displayed when the unit is turned on for the first time. Select the items with the remote control. Unit buttons are invalid.

OSD LANGUAGE

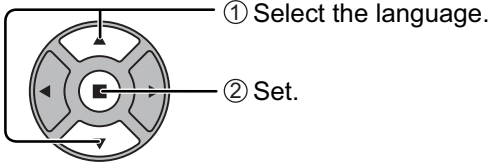

PRESENT TIME SETUP

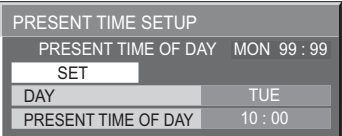
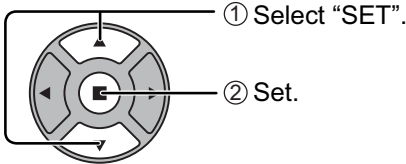
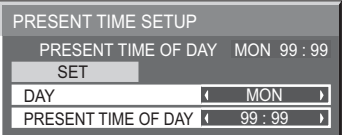
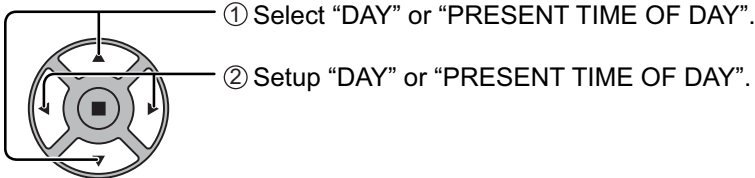

Notes:

- Once the items are set, the screens won't be displayed when switching on the unit next time.
- After the setting, the items can be changed in the following menus.
OSD LANGUAGE (see page 34)
PRESENT TIME SETUP (see page 28)

From the second time on, the below screen is displayed for a while (setting condition is an example).

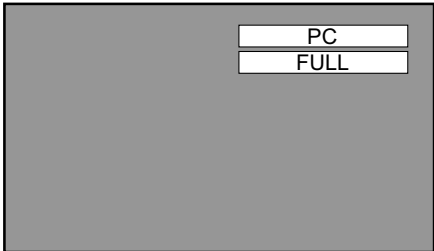

Selecting the input signal

INPUT



Press to select the input signal to be played back from the equipment which has been connected to the Display.

Input signals will change as follows:

→ PC → DVI → HDMI1 → HDMI2 → VIDEO → Component*

PC: PC input terminal in PC IN.

DVI: DVI input terminal in DVI-D IN.

HDMI1: HDMI input terminal in AV IN (HDMI1).

HDMI2: HDMI input terminal in AV IN (HDMI2).

VIDEO: Video input terminal in AV IN (VIDEO/S-VIDEO).

Component*: Component or RGB input terminal in COMPONENT/RGB IN.

* "Component" may be displayed as "RGB" depending on the setting of "COMPONENT/RGB-IN SELECT". (see page 37)

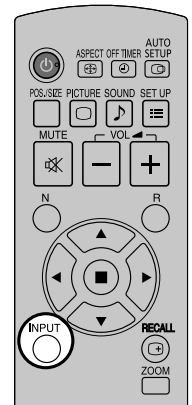

Notes:

- Selecting is also possible by pressing the INPUT button on the unit.
- Select to match the signals from the source connected to the component/RGB input terminals. (see page 37)

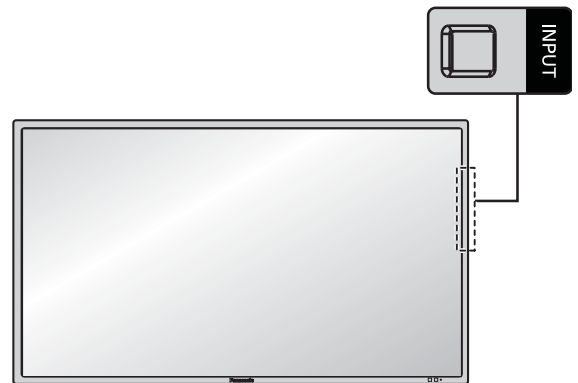

Basic Controls

Main Unit

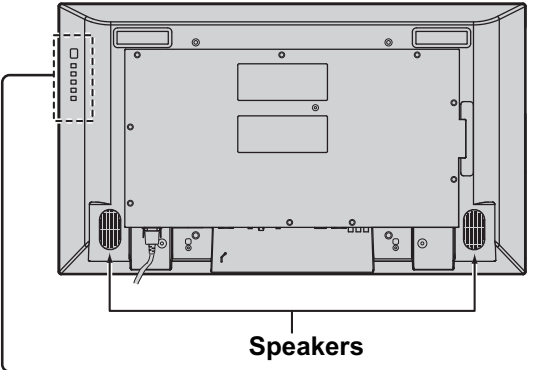
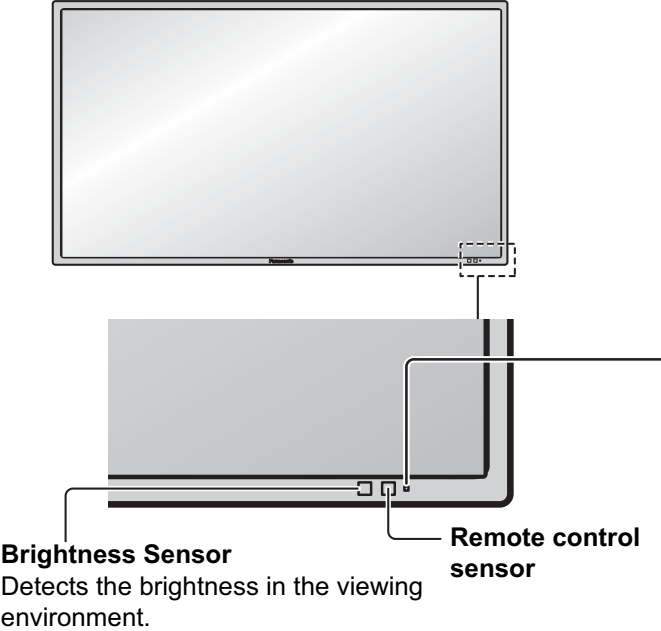

- Power Indicator**
The Power Indicator will light.
- Power-OFF Indicator not illuminated (The unit will still consume some power as long as the power cord is still inserted into the wall outlet.)
 - Standby Red
 - Power-ON Green
 - POWER MANAGEMENT (DPMS) Orange (With PC input signal. See page 32)

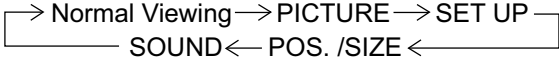
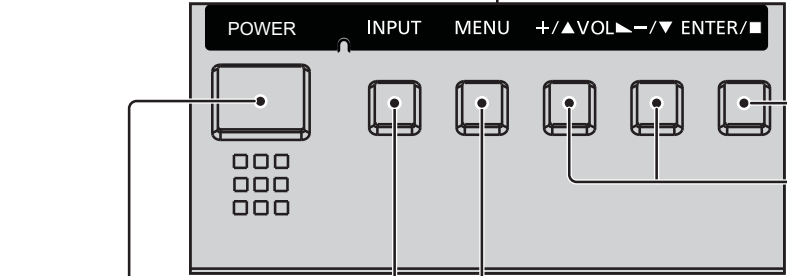

Basic Controls

Remote Control Transmitter

ACTION button
Press to make selections.

ASPECT button
Press to adjust the aspect.
(see page 19)

Standby (ON / OFF) button
The Display must first be plugged into the wall outlet and turned on at the power switch (see page 14). Press this button to turn the Display On, from Standby mode. Press it again to turn the Display Off to Standby mode.

POS. /SIZE button
(see page 23)

PICTURE button
(see page 25)

Sound mute On / Off
Press this button to mute the sound. Press again to reactivate sound. Sound is also reactivated when power is turned off or volume level is changed.

N button
(see page 24, 25, 26, 27)

POSITION buttons

INPUT button
Press to select input signal sequentially.
(see page 16)

OFF TIMER button

The Display can be preset to switch to stand-by after a fixed period. The setting changes to 30 minutes, 60 minutes, 90 minutes and 0 minutes (off timer cancelled) each time the button is pressed.

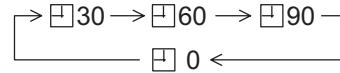

When three minutes remain, "OFF TIMER 3" will flash. The off timer is cancelled if a power interruption occurs.

AUTO SETUP button

Automatically adjusts the position/size of the screen. (see page 23)

SET UP button (see page 21)

SOUND button (see page 27)

Volume Adjustment

Press the Volume Up "+" or Down "-" button to increase or decrease the sound volume level.

R button (see page 21)

Press the R button to return to previous menu screen.

RECALL button

Press the "RECALL" button to display the current system status.

- ① Input label
- ② Aspect mode (see page 19)
- ③ Off timer
- ④ Clock display (see page 43)

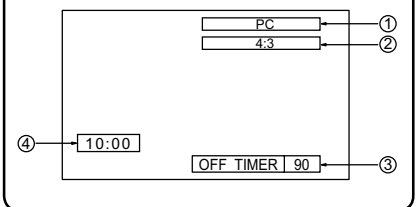

Digital Zoom (see page 20)

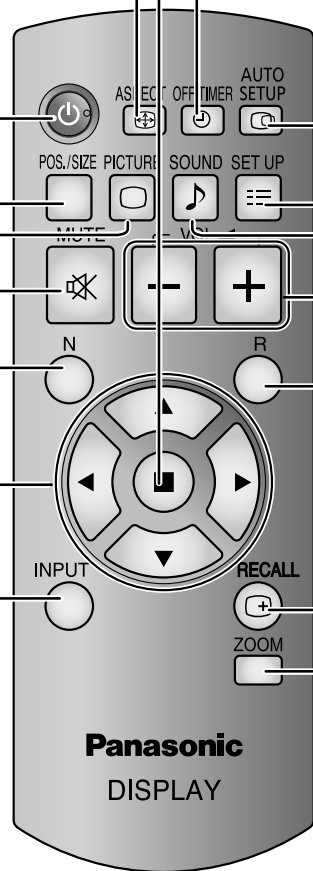

ASPECT Controls

The Display will allow you to enjoy viewing the picture at its maximum size, including wide screen cinema format picture.

Note:

Be aware that if you put the display in a public place for commercial purposes or a public showing and then use the aspect mode select function to shrink or expand the picture, you may be violating the copyright under copyright law. It is prohibited to show or alter the copyrighted materials of other people for commercial purposes without the prior permission of the copyright holder.

ASPECT



Press repeatedly to move through the aspect options:

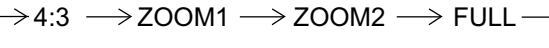

[from the unit]

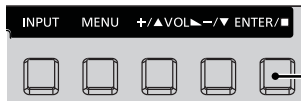

The aspect mode changes each time the ENTER button is pressed.

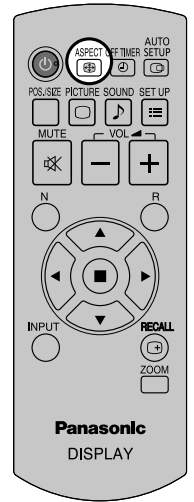

Note:

The aspect mode is memorized separately for each input terminal.

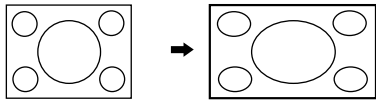
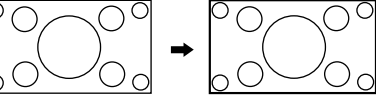
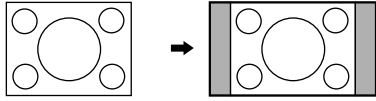
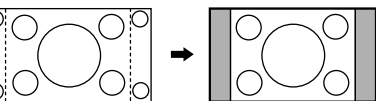
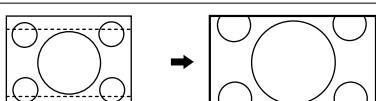
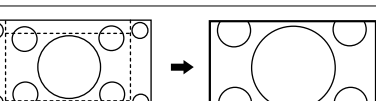
Aspect mode	Picture → Enlarged screen	Description
FULL		The display of the pictures fills the screen. In the case of SD signals, pictures with a 4:3 aspect ratio are enlarged horizontally, and displayed. This mode is suited to displaying anamorphic pictures with a 16:9 aspect ratio.
		
4:3		Pictures with a 4:3 aspect ratio are displayed with their original aspect ratio. Side panels are displayed at the left and right edges of the screen.
		Pictures with a 16:9 aspect ratio are displayed with their original aspect ratio. The left and right edges of the pictures are masked by side panels.
ZOOM1		Letterbox pictures with a 16:9 aspect ratio are enlarged vertically and horizontally so that their display fills the screen. The top and bottom edges of the pictures are cut off.
ZOOM2		Letterbox pictures with a 16:9 aspect ratio are enlarged vertically and horizontally so that their display fills the screen. The top and bottom edges as well as the left and right edges of the pictures are cut off.

Digital Zoom

This displays an enlargement of the designated part of the displayed image.

1 Display the operation guide.

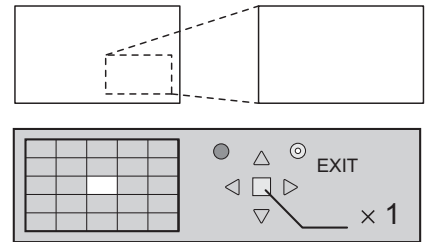
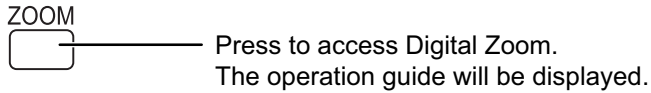

During Digital Zoom, only the following buttons can be operated.

[Remote control]

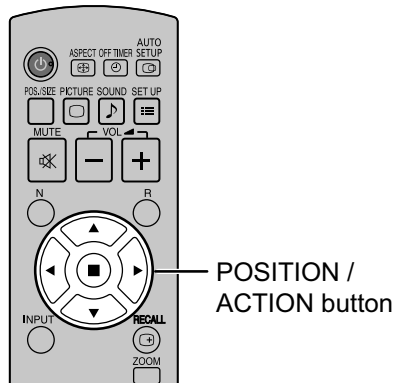

2 Select the area of the image to be enlarged.

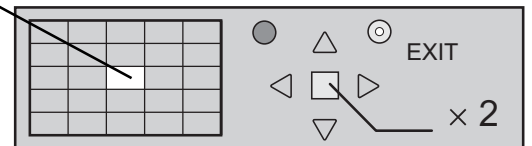
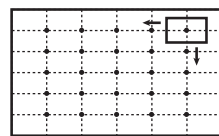
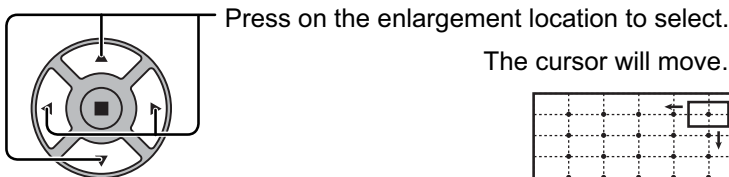

3 Select the magnification required for the enlarged display.

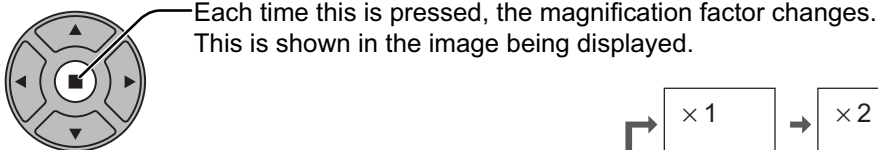

4 Return to normal display (quit Digital Zoom).

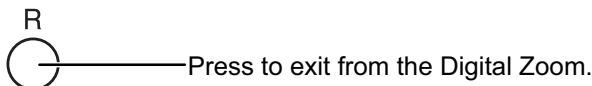

Notes:

- When power goes OFF (including "Off Timer" operation), Digital Zoom terminates.
- The Digital Zoom function cannot be selected while in the following operation state:
When MULTI DISPLAY SETUP is ON (see page 35).
When SCREENSAVER is running. (see page 30)
- While Digital Zoom is in operation, "Adjusting POS. /SIZE" cannot be used.

On-Screen Menu Displays

Remote Control

Unit

1 Display the menu screen.

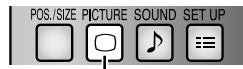

Press to select.
(Example: PICTURE menu)

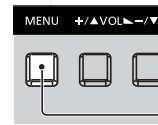

Press several times.

Each time the MENU button is pressed, the menu screen will switch.

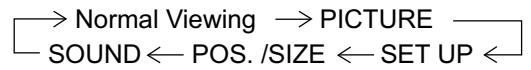

2 Select the item.

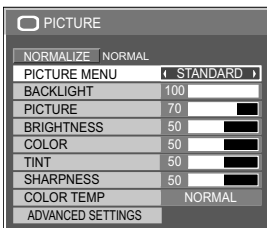

(Example: PICTURE menu)

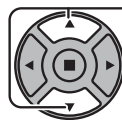

Select.

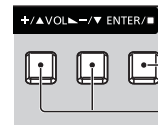

2 Press.

1 Select.

3 Set.

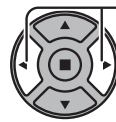

Adjust.

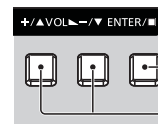

2 Press.

1 Adjust.

4 Exit the menu.



Press.
Press to return to the previous menu.

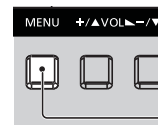

Press several times.

On-Screen Menu Displays

Overview

Note: Menu that cannot be adjusted is grayout. Adjustable menu changes depending on signal, input and menu setting.

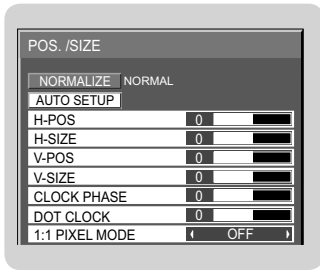

Page 23, 24

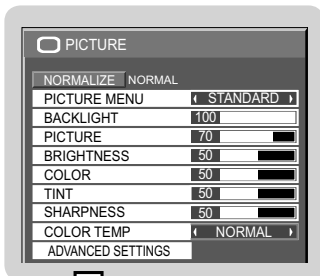

Page 25, 26

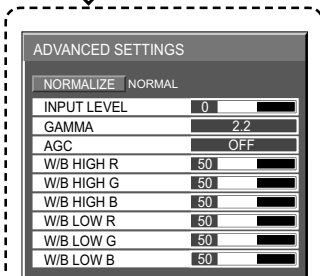

Page 25, 26

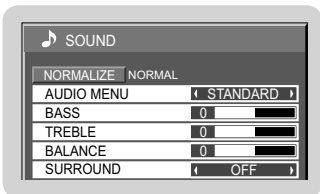

Page 27

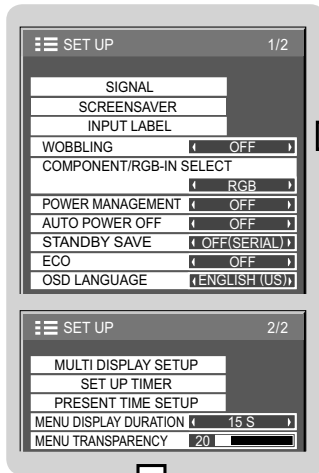

Page 28-41

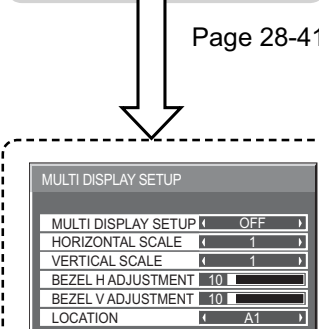

Page 35, 36

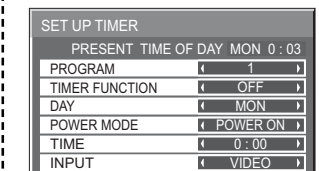

Page 29

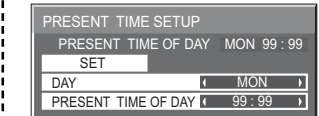

Page 28

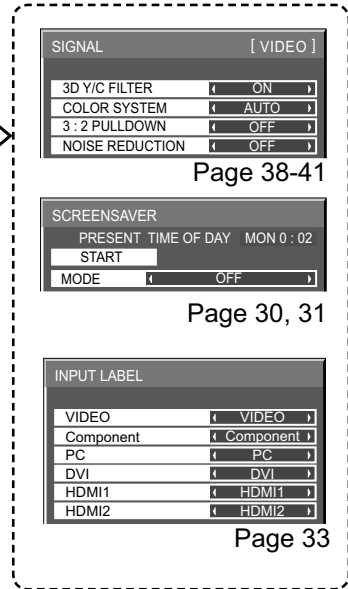



Page 38-41

Page 30, 31

Page 33

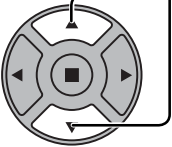
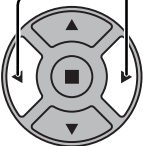
Adjusting POS. /SIZE

- 1  Press to display the POS. /SIZE menu.
- 2  Press to select the menu to adjust.
- 3  Press to adjust the menu.
- 4  Press to exit from adjust mode.

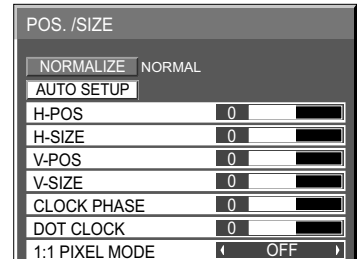

Note:

Unadjustable items are grayed out. Adjustable items differ depending on the input signal and the display mode.

Note:

If a "Cue" or "Rew" signal from a VCR or DVD player is received, the picture position will shift up or down. This picture position movement cannot be controlled by the POS. /SIZE function.

AUTO SETUP

H-POS/V-POS, H-SIZE/V-SIZE, DOT CLOCK and CLOCK PHASE are automatically adjusted when the RGB or PC signal is received. This setting only operates when a PC signal or RGB signal is input, and the aspect is "FULL".

Using Remote Control

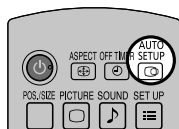

When  on the remote control is pressed, "AUTO SETUP" will be executed.

When AUTO SETUP does not work, "INVALID" is displayed.

Notes:

- When digital RGB signal input, DOT CLOCK and CLOCK PHASE cannot be made.
- AUTO SETUP may not work when a cropped or dark image is input. In such case, switch to a bright image with borders and other objects are clearly shown, and then try auto setup again.
- Depending on the signal, out of alignment may occur after AUTO SETUP. Carry out fine tuning for the position/size as required.
- If AUTO SETUP cannot set properly for vertical frequency 60Hz XGA signal (1024×768@60Hz and 1366×768@60Hz), pre-selecting the individual signal in "XGA MODE" (see page 39) may results in correct AUTO SETUP.
- AUTO SETUP does not work well when a signal such as additional information is superimposed out of valid image period or intervals between synchronizing and image signals are short.
- If AUTO SETUP cannot adjust correctly, select "NORMALIZE" once and press ACTION (■) then adjust POS. /SIZE manually.
- If the picture goes off screen in the horizontal direction as a result of performing AUTO SETUP, perform DOT CLOCK adjustment.

Adjusting POS. /SIZE

H-POS

Adjust the horizontal position.

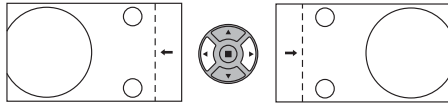

V-POS

Adjust the vertical position.

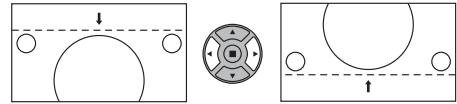

H-SIZE

Adjust the horizontal size.

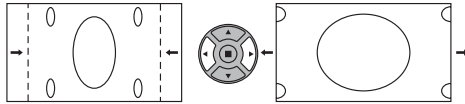

V-SIZE

Adjust the vertical size.

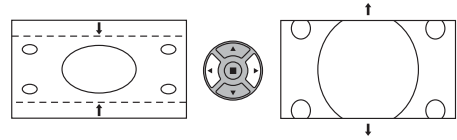

CLOCK PHASE

(During Component, RGB and PC input signal)

Eliminate the flickering and distortion.

DOT CLOCK

(During Component, RGB and PC input signal)

Periodic striped pattern interference (noise) may occur when a striped pattern is displayed. If this happens, adjust so that any such noise is minimized.

OVER SCAN

Turn image over scan ON/OFF.

Configurable signals are as follows:

525i, 525p, 625i, 625p, 750/60p, 750/50p (Component Video, DVI, HDMI)

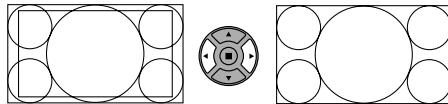

ON

OFF

Notes:

- "OFF" is effective during only "FULL" aspect mode.
- When "OFF" is set, "H-SIZE" and "V-SIZE" cannot be adjusted.

1:1 PIXEL MODE Adjusts the display size when 1125i, 1125p or 1250i signal is input.

Notes:

- "ON" is effective during only "FULL" aspect mode.
- Select ON when you would like to replay 1920 × 1080 input signal.
- Applicable input signal;
1125 (1080) / 50i · 60i · 24sF · 24p · 25p · 30p · 50p · 60p
- Select OFF when flickering is shown around the image.
- H-SIZE and V-SIZE cannot be adjusted when ON is selected.

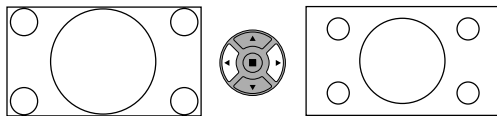

OFF

ON

Helpful Hint (/ **NORMALIZE** Normalization)

While the POS. /SIZE display is active, if either the N button on the remote control is pressed at any time or the ACTION () button is pressed during "NORMALIZE", then all adjustment values (except "CLOCK PHASE" and "DOT CLOCK") are returned to the factory settings.

PICTURE Adjustments

1  Press to display the PICTURE menu.

2 Select to adjust each item.

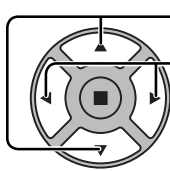
 Press to select the menu to adjust.
 Select the desired level by looking at the picture behind the menu.

Note:
 Menu that cannot be adjusted is grayout. Adjustable menu changes depending on signal, input and menu setting.

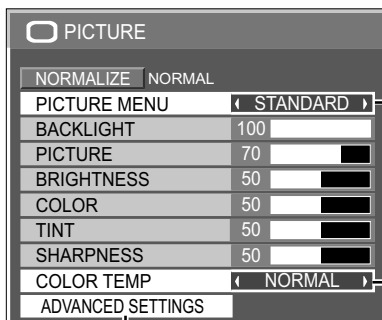

Press the left ◀ or right ▶ button to switch between modes.



STANDARD

For viewing in standard (evening lighting) environments. This menu selects the normal levels of BRIGHTNESS and PICTURE.

DYNAMIC

For viewing in brighter environments. This menu selects higher than normal levels of BRIGHTNESS and PICTURE.

CINEMA

Ideal for movies.

Note:

If you would like to change the picture and color of the selected PICTURE menu to something else, adjust using the items in the PICTURE menu. (see next page)

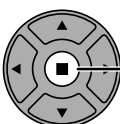
 Press to enter Advanced Settings.

ADVANCED SETTINGS
 Enables fine picture adjustment at a professional level (see next page).

ADVANCED SETTINGS	
NORMALIZE	NORMAL
INPUT LEVEL	0
GAMMA	2.2
AGC	OFF
WB HIGH R	50
WB HIGH G	50
WB HIGH B	50
WB LOW R	50
WB LOW G	50
WB LOW B	50













Press the left ◀ or right ▶ button to switch between modes.



Helpful Hint ( / NORMALIZE Normalization)

While the "PICTURE" menu is displayed, if either the N button on the remote control is pressed at any time or the ACTION (■) button is pressed during "NORMALIZE", then all adjustment values are returned to the factory settings.



















PICTURE Adjustments

Item	Effect	Adjustments
BACKLIGHT	 Darker  Brighter	Adjusts luminance of the back light.
PICTURE	 Less  More	Adjusts the proper picture contrast.
BRIGHTNESS	 Darker  Brighter	Adjusts for easier viewing of dark pictures such as night scenes and black hair.
COLOR	 Less  More	Adjusts color saturation.
TINT	 Reddish  Greenish	Adjusts for natural flesh tones.
SHARPNESS	 Less  More	Adjusts picture sharpness.

Notes:

- “COLOR” setting can be adjusted for Video input signal.
- You can change the level of each function (BACKLIGHT, PICTURE, BRIGHTNESS, COLOR, TINT, SHARPNESS) for each PICTURE MENU.
- The setting details for STANDARD, DYNAMIC and CINEMA respectively are memorized separately for each input terminal.
- The “TINT” setting can be adjusted for NTSC signal only during Video (S Video) input signal.
- In PICTURE, there is not a noticeable change even when contrast is increased with a bright picture or reduced with a dark picture.

ADVANCED SETTINGS

Item	Effect	Details
INPUT LEVEL	 Less  More	Adjustment of parts which are extremely bright and hard to see.
GAMMA	 Down  Up	S CURVE \longleftrightarrow 2.0 \longleftrightarrow 2.2 \longleftrightarrow 2.6
AGC	 OFF  ON	Increases the brightness of dark signal automatically.
W/B HIGH R	 Less  More	Adjusts the white balance for light red areas.
W/B HIGH G	 Less  More	Adjusts the white balance for light green areas.
W/B HIGH B	 Less  More	Adjusts the white balance for light blue areas.
W/B LOW R	 Less  More	Adjusts the white balance for dark red areas.
W/B LOW G	 Less  More	Adjusts the white balance for dark green areas.
W/B LOW B	 Less  More	Adjusts the white balance for dark blue areas.

Notes:

- Carry out “W/B” adjustment as follows.
 1. Adjust the white balance of the bright sections using the “W/B HIGH R”, “W/B HIGH G” and “W/B HIGH B” settings.
 2. Adjust the white balance of the dark sections using the “W/B LOW R”, “W/B LOW G” and “W/B LOW B” settings.
 3. Repeat steps 1 and 2 to adjust.
 Steps 1 and 2 affect each other’s settings, so repeat each step in turn to make the adjustment.
- The adjustment values are memorized separately for each input terminal.
- The adjustment range values should be used as an adjustment reference.

Helpful Hint (/ NORMALIZE Normalization)

On the remote control unit, while the “ADVANCED SETTINGS” menu is displayed, if either the N button is pressed at any time or the ACTION () button is pressed during “NORMALIZE”, then all adjustment values are returned to the factory settings.

SOUND Adjustment

1  Press to display the SOUND menu.

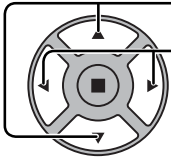
2 Select to adjust each item.
 Press to select the menu to adjust.
 Select the desired level by listening to the sound.

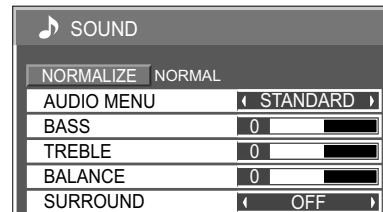

3  Press to exit from adjust mode.

Item	Details
AUDIO MENU	STANDARD: Emits the original sound. DYNAMIC: Accentuates sharp sound. CLEAR: Attenuates human voice.
BASS	Adjusts low pitch sounds.
TREBLE	Adjusts high pitch sound.
BALANCE	Adjusts left and right volumes.
SURROUND	Select ON or OFF.

Note: BASS, TREBLE and SURROUND settings are memorized separately for each AUDIO MENU.

Helpful Hint (/ **NORMALIZE** Normalization)

While the "SOUND" menu is displayed, if either the N button on the remote control is pressed at any time or the ACTION (■) button is pressed during "NORMALIZE", then all adjustment values are returned to the factory settings.

PRESENT TIME SETUP / SET UP TIMER

The timer can switch the Display ON or OFF.

Before attempting Timer Set, confirm the PRESENT TIME OF DAY and adjust if necessary. Then set POWER ON TIME / POWER OFF TIME.

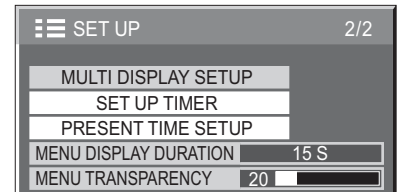

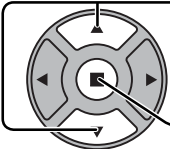
- 1  Press to display the SET UP menu.
- 2  Press to select SET UP TIMER or PRESENT TIME SETUP.
Press to display the SET UP TIMER screen or PRESENT TIME SETUP screen.

PRESENT TIME SETUP

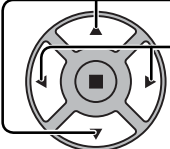
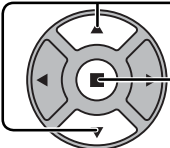
- 1  Press to select DAY or PRESENT TIME OF DAY.
Press to set up DAY or PRESENT TIME OF DAY.
▶ button: Forward
◀ button: Back
Notes:
 - Pressing “◀” or “▶” button once changes PRESENT TIME OF DAY 1 minute.
 - Pressing “◀” or “▶” button continuously changes PRESENT TIME OF DAY by 15 minutes.
- 2  Press to select SET.
Press to store PRESENT TIME SETUP.
Notes:
 - SET cannot be selected unless PRESENT TIME OF DAY is set.
 - Unless setting the present time other than “99:99”, “DAY” and “PRESENT TIME OF DAY” cannot be set.
 - The settings of “DAY” and “PRESENT TIME OF DAY” are reset when leaving the display turned off for about 7 days for the following reasons:
Pressing POWER switch of the unit to turn off the display.
Disconnecting the AC cord.
Interruption of power supply.

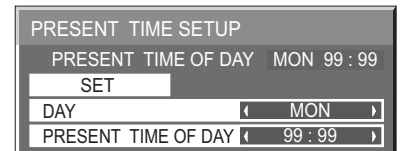

SET UP TIMER

Set the program for turning the power ON/OFF and select the input signal at the specified time. Up to 20 programs can be set.

[Setting Example]

Program 1, Every Monday, 12:00, Power On, Input: VIDEO

SET UP TIMER	
PRESENT TIME OF DAY MON 0 : 03	
PROGRAM	1
TIMER FUNCTION	ON
DAY	MON
POWER MODE	POWER ON
TIME	12 : 00
INPUT	VIDEO

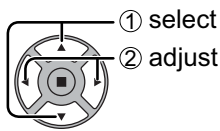

- 1 Set the program number.
- 2 To execute the program, set to "ON".
The program is disabled when "OFF" is set.
- 3 Set the day.
The program is executed every day when "Everyday" is set.
- 4 Set the power ON/OFF.
- 5 Set the time.
Pressing "◀" or "▶" button once changes "TIME" 1 minute.
Pressing "◀" or "▶" button continuously changes "TIME" by 15 minutes.
- 6 Set the input.

Notes:

- This function cannot be set unless "PRESENT TIME SETUP" is set.
- If more than one programs are set for the same time, only the program with the smallest program number is enabled.

SCREENSAVER (For preventing image retention)

Do not display a still picture, especially in 4:3 mode, for any length of time.

If the display must remain on, a SCREENSAVER should be used.

When the screen saver is operating, the following 5 patterns are displayed full screen for 5 seconds each.

Black→Dark Gray→Gray→Light Gray→White

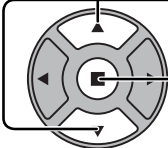
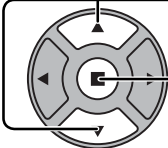
- 1  Press to display the SET UP menu.
- 2  Press to select the SCREENSAVER.
 Press to select the SCREENSAVER screen.

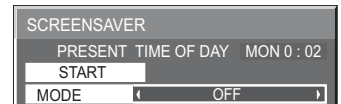

3 MODE selection

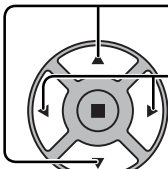
- 
- Press to select the MODE.
 - Press to select each mode items.

- Off
- ↕
- INTERVAL : Operates when SHOW DURATION and SAVER DURATION are set up and those times arrive.
- ↕
- TIME OF DAY : Operates when START TIME and FINISH TIME are set up and those times arrive.
- ↕
- STANDBY AFTER SCR SAVER: Operates while SCREENSAVER DURATION, and display enters standby mode.
- ↕
- ON : Operates when START is selected and the ACTION (■) button is pressed.

4 START setting

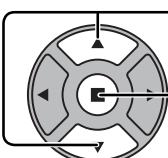
- 
- When the MODE is set to ON, press to select START.
 - Press to start SCREENSAVER.

The menu screen will disappear and the SCREENSAVER will be activated. **To stop the SCREENSAVER under ON, press the R button or any buttons on the main unit.**

Note: When the display is turned off, the SCREENSAVER will be deactivated.

SCREENSAVER (For preventing image retention)

Setup of SCREENSAVER Time

After selecting TIME OF DAY, INTERVAL or STANDBY AFTER SCR SAVER, the relevant Time Setup will become available for selection and the Operating Time may be set. (Time cannot be set when "MODE" is "ON" or "OFF".)

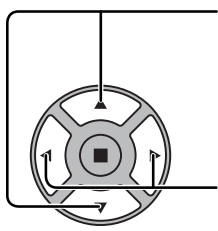

- Press to select START TIME / FINISH TIME (When TIME OF DAY is selected).
- Press to select SHOW DURATION / SAVER DURATION (When INTERVAL is selected).
- Press to select SCREENSAVER DURATION (When STANDBY AFTER SCR SAVER is selected).
- Press to setup.
 - ▶ button: Forward
 - ◀ button: Back

Notes:

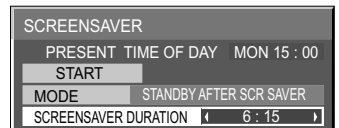
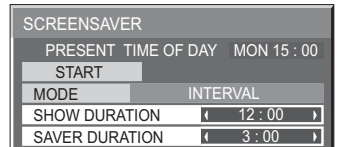
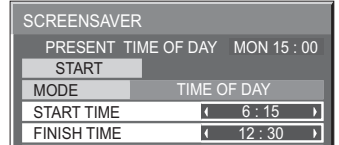

- Pressing "◀" or "▶" button once changes the Time 1 minute. [However, switching occurs every 15 minutes when Periodic Time is selected.]
- Pressing "◀" or "▶" button continuously changes the Time by 15 minutes.
- "SCREENSAVER DURATION" of the "STANDBY AFTER SCR SAVER" can be set from 0:00 to 23:59. When this is set to "0:00", "STANDBY AFTER SCR SAVER" will not be activated.

Note: Timer function will not work unless "PRESENT TIME OF DAY" is set.

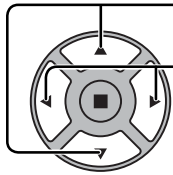

WOBBLING

Automatically shifts the display image (therefore unnoticeable to the eye) to prevent image retention of sharper contour of image.

- 1  Press to display the SET UP menu.
- 2  Press to select "WOBBLING".
Press to select "ON" or "OFF".
ON: Shifts the position of the display image on a fixed time interval.
- 3  Press to exit from adjust mode.



Notes:

- If "MULTI DISPLAY SETUP" is set to "ON", this function does not operate.
- When this function is operating, part of the screen may appear to be missing.

Reduces power consumption

- **POWER MANAGEMENT:** When this function is set to ON, it operates under the following conditions to turn the power on or off automatically.
 When no pictures are detected for 30 or so seconds during PC signal input:
 → Power is turned off (standby); the power indicator lights up orange.
 When pictures are subsequently detected:
 → Power is turned on; the power indicator lights up green.
Notes:
 - This function operates only during input from PC IN terminal.
 - This function is effective when “SYNC” is set to “AUTO” and during normal viewing (one picture screen).
- **AUTO POWER OFF:** Equipment power supply is turned OFF when there is no signal.
 When this is set to ON, the power supply of the unit goes Off 10 minutes after the input signals stop.
Note: This function is effective during normal viewing (one picture screen).
- **STANDBY SAVE:** When this function is set to “ON”, serial communication is disabled during standby mode, reducing the power consumption during standby.
 To perform serial communication while in standby, set this function to “OFF(SERIAL)”.
 However, the standby power consumption is greater than when it is set to “ON”.
- **ECO:** This function adjusts the brightness of the backlight to reduce power consumption.
 OFF: This function does not operate.
 ON: Backlight brightness is reduced.
 SENSOR: The backlight brightness is automatically adjusted according to the viewing environment.
Note: When this function is set to “ON” or “SENSOR”, the “BACKLIGHT” setting in the PICTURE menu is disabled.

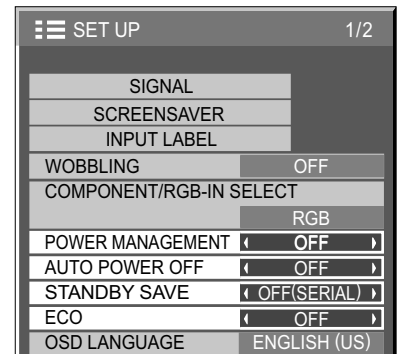
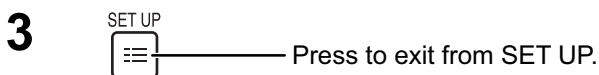
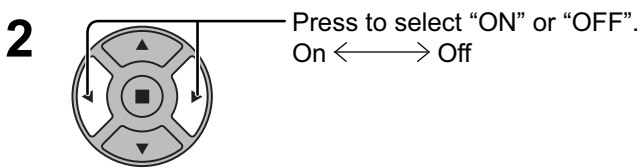
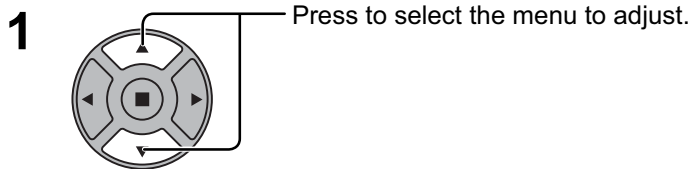

Customizing the Input labels

This function can change the label of the Input signal to be displayed. (see page 16)

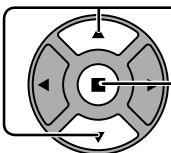
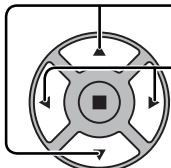
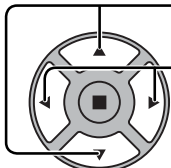
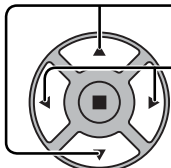
- 1  Press to display the SETUP menu.
- 2  Press to select INPUT LABEL.
 Press to display the INPUT LABEL screen.
- 3  Press to select image input.
 Press to change input label.

SET UP		1/2
SIGNAL		
SCREEN SAVER		
INPUT LABEL		
WOBLING	OFF	
COMPONENT/RGB-IN SELECT	RGB	
POWER MANAGEMENT	OFF	
AUTO POWER OFF	OFF	
STANDBY SAVE	OFF(SERIAL)	
ECO	OFF	
OSD LANGUAGE	ENGLISH (US)	

INPUT LABEL	
VIDEO	VIDEO
Component	Component
PC	PC
DVI	DVI
HDMI1	HDMI1
HDMI2	HDMI2

Image input	Input label
[VIDEO]	VIDEO / DVD1 / DVD2 / DVD3 / Blu-ray1 / Blu-ray2 / Blu-ray3 / CATV / VCR / STB / (SKIP)
[Component]*	Component / DVD1 / DVD2 / DVD3 / Blu-ray1 / Blu-ray2 / Blu-ray3 / CATV / VCR / STB / (SKIP)
[PC]	PC / DVD1 / DVD2 / DVD3 / Blu-ray1 / Blu-ray2 / Blu-ray3 / CATV / VCR / STB / (SKIP)
[DVI]	DVI / DVD1 / DVD2 / DVD3 / Blu-ray1 / Blu-ray2 / Blu-ray3 / CATV / VCR / STB / (SKIP)
[HDMI1]	HDMI1 / DVD1 / DVD2 / DVD3 / Blu-ray1 / Blu-ray2 / Blu-ray3 / CATV / VCR / STB / (SKIP)
[HDMI2]	HDMI2 / DVD1 / DVD2 / DVD3 / Blu-ray1 / Blu-ray2 / Blu-ray3 / CATV / VCR / STB / (SKIP)

(SKIP) : The INPUT button press will skip its input.

* "Component" may be displayed as "RGB" depending on the setting of "COMPONENT/RGB-IN SELECT".
(see page 37)

Selecting the On-Screen Menu Language

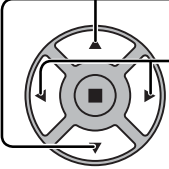
- 1  Press to display the SET UP menu.
- 2  Press to select OSD LANGUAGE.
Press to select your preferred language.

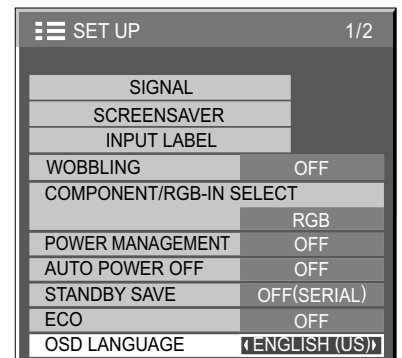

■ Selectable languages

- English (UK)
- ↕
- Deutsch
- ↕
- Français
- ↕
- Italiano
- ↕
- Español
- ↕
- English (US)
- ↕
- 中文.....(Chinese)
- ↕
- 日本語.....(Japanese)
- ↕
- Русский.....(Russian)

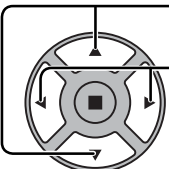
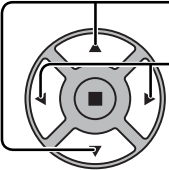

Customizing the On-Screen Menu Display

Set the display time and background transparency of the on-screen menu display.

- 1  Press to display the SET UP menu.
- 2  Press to select "MENU DISPLAY DURATION".
Press to adjust the display duration.
- 3  Press to select "MENU TRANSPARENCY".
Press to adjust the transparency.
- 4  Press to exit from adjust mode.

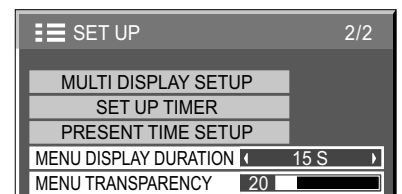

SET UP for MULTI DISPLAY

By lining up the Displays in groups, for example, as illustrated below, an enlarged picture may be displayed across all screens.

For this mode of operation, each display has to be set up with a Display number to determine its location.

(Example)



group of 4 (2 × 2) group of 9 (3 × 3) group of 16 (4 × 4) group of 25 (5 × 5)

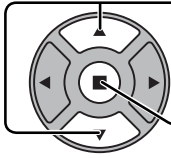
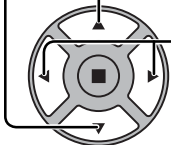
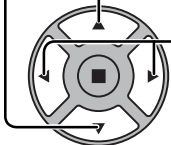
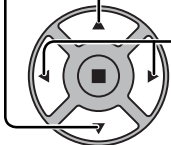

How to setup MULTI DISPLAY

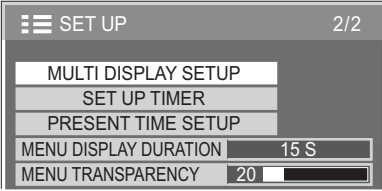
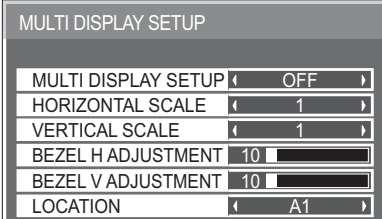
- 1  Press to display the SET UP menu.
- 2  Press to select the MULTI DISPLAY SETUP.
 Press to display the "MULTI DISPLAY SETUP" menu.
- 3  Press to select the MULTI DISPLAY SETUP.
 Press to select "ON" or "OFF".

Item	Details
MULTI DISPLAY SETUP	Select "ON" or "OFF".
HORIZONTAL SCALE	Select "1", "2", "3", "4", "5".
VERTICAL SCALE	Select "1", "2", "3", "4", "5".
BEZEL H ADJUSTMENT BEZEL V ADJUSTMENT	<p>Areas of the image that are hidden by the joint sections are adjusted both horizontally and vertically (0~100).</p> <div style="display: flex; justify-content: space-around;"> <div style="text-align: center;"> <p>To show joints between displays.</p>  <p>Example</p> <p>Suitable for still image display. Setting value: 0</p> </div> <div style="text-align: center;"> <p>To hide joints between displays.</p>  <p>Example</p> <p>Suitable for moving image display. Setting value: 100</p> </div> </div>

SET UP for MULTI DISPLAY

Item	Details																																																									
LOCATION	<p>Select the required arrangement number. (A1-E5 : Refer to the following)</p> <p>Display Number locations for each arrangement.</p> <p>(Examples)</p> <div style="display: flex; justify-content: space-around; align-items: flex-start;"> <div style="text-align: center;"> <p>(2 × 1)</p> <table border="1" style="margin: 0 auto;"> <tr><td>A1</td><td>A2</td></tr> </table> </div> <div style="text-align: center;"> <p>(2 × 3)</p> <table border="1" style="margin: 0 auto;"> <tr><td>A1</td><td>A2</td></tr> <tr><td>B1</td><td>B2</td></tr> <tr><td>C1</td><td>C2</td></tr> </table> </div> <div style="text-align: center;"> <p>(4 × 2)</p> <table border="1" style="margin: 0 auto;"> <tr><td>A1</td><td>A2</td><td>A3</td><td>A4</td></tr> <tr><td>B1</td><td>B2</td><td>B3</td><td>B4</td></tr> </table> </div> <div style="text-align: center;"> <p>(4 × 4)</p> <table border="1" style="margin: 0 auto;"> <tr><td>A1</td><td>A2</td><td>A3</td><td>A4</td></tr> <tr><td>B1</td><td>B2</td><td>B3</td><td>B4</td></tr> <tr><td>C1</td><td>C2</td><td>C3</td><td>C4</td></tr> <tr><td>D1</td><td>D2</td><td>D3</td><td>D4</td></tr> </table> </div> <div style="text-align: center;"> <p>(5 × 5)</p> <table border="1" style="margin: 0 auto;"> <tr><td>A1</td><td>A2</td><td>A3</td><td>A4</td><td>A5</td></tr> <tr><td>B1</td><td>B2</td><td>B3</td><td>B4</td><td>B5</td></tr> <tr><td>C1</td><td>C2</td><td>C3</td><td>C4</td><td>C5</td></tr> <tr><td>D1</td><td>D2</td><td>D3</td><td>D4</td><td>D5</td></tr> <tr><td>E1</td><td>E2</td><td>E3</td><td>E4</td><td>E5</td></tr> </table> </div> </div>	A1	A2	A1	A2	B1	B2	C1	C2	A1	A2	A3	A4	B1	B2	B3	B4	A1	A2	A3	A4	B1	B2	B3	B4	C1	C2	C3	C4	D1	D2	D3	D4	A1	A2	A3	A4	A5	B1	B2	B3	B4	B5	C1	C2	C3	C4	C5	D1	D2	D3	D4	D5	E1	E2	E3	E4	E5
A1	A2																																																									
A1	A2																																																									
B1	B2																																																									
C1	C2																																																									
A1	A2	A3	A4																																																							
B1	B2	B3	B4																																																							
A1	A2	A3	A4																																																							
B1	B2	B3	B4																																																							
C1	C2	C3	C4																																																							
D1	D2	D3	D4																																																							
A1	A2	A3	A4	A5																																																						
B1	B2	B3	B4	B5																																																						
C1	C2	C3	C4	C5																																																						
D1	D2	D3	D4	D5																																																						
E1	E2	E3	E4	E5																																																						

4



Press to exit from adjust mode.

SET UP for Input Signals

COMPONENT / RGB IN SELECT

Select to match the signals from the source connected to the COMPONENT/RGB IN terminal.

Y, P_B, P_R signals ⇔ "COMPONENT"

RGB signals ⇔ "RGB"

1  Press to display the SET UP menu.

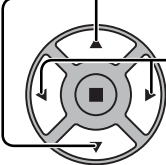
2  Press to select the "COMPONENT / RGB-IN SELECT".
Press to select the desired mode.
COMPONENT ← → RGB

3  Press to exit from adjust mode.

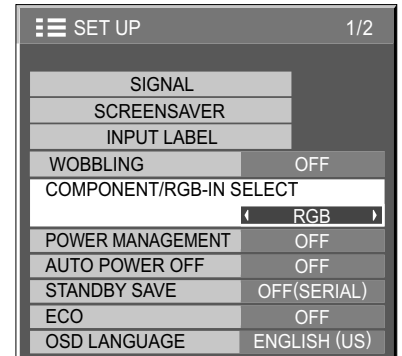

SET UP 1/2	
SIGNAL	
SCREENSAVER	
INPUT LABEL	
WOBBLING	OFF
COMPONENT/RGB-IN SELECT	RGB
POWER MANAGEMENT	OFF
AUTO POWER OFF	OFF
STANDBY SAVE	OFF(SERIAL)
ECO	OFF
OSD LANGUAGE	ENGLISH (US)

Note:



Make setting of the selected input terminal (COMPONENT/RGB IN).

SET UP for Input Signals

SIGNAL menu

Note:

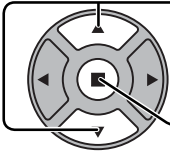
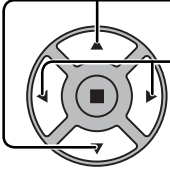
"SIGNAL" setup menu displays a different setting condition for each input signal.

- 1  Press to display the SET UP menu.
- 2  Press to select the "SIGNAL".
Press to display the SIGNAL menu.
- 3  Press to select the menu to adjust.
Press to adjust the menu.
- 4  Press to exit from adjust mode.

SET UP 1/2	
SIGNAL	
SCREENSAVER	
INPUT LABEL	
WOBBLING	OFF
COMPONENT/RGB-IN SELECT	RGB
POWER MANAGEMENT	OFF
AUTO POWER OFF	OFF
STANDBY SAVE	OFF(SERIAL)
ECO	OFF
OSD LANGUAGE	ENGLISH (US)

↓ Press ACTION (■) button

For VIDEO (S VIDEO)

SIGNAL [VIDEO]	
3D Y/C FILTER	ON
COLOR SYSTEM	AUTO
3 : 2 PULLDOWN	OFF
NOISE REDUCTION	OFF

For RGB

SIGNAL [RGB]	
SYNC	AUTO
3 : 2 PULLDOWN	OFF
XGA MODE	1024×768
NOISE REDUCTION	OFF
H-FREQ.	63.98 kHz
V-FREQ.	60.02 Hz
SIGNAL FORMAT	1280×1024/60

For COMPONENT

SIGNAL [COMPONENT]	
3 : 2 PULLDOWN	OFF
XGA MODE	1024×768
NOISE REDUCTION	OFF
H-FREQ.	63.98 kHz
V-FREQ.	60.02 Hz
SIGNAL FORMAT	1280×1024/60

For Digital

SIGNAL [Digital]	
3 : 2 PULLDOWN	OFF
NOISE REDUCTION	OFF
H-FREQ.	63.98 kHz
V-FREQ.	60.02 Hz
DOT CLOCK FREQ.	108.0 MHz
SIGNAL FORMAT	1280×1024/60

3D Y/C FILTER

Select "SIGNAL" from the "SET UP" menu during Video (S Video) input signal mode. ("SIGNAL [VIDEO]" menu is displayed.)

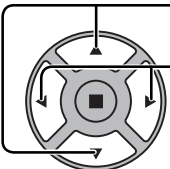
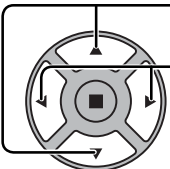
- 1  Press to select the "3D Y/C FILTER".
- 2  Press to set ON / OFF.

3D Y/C FILTER	ON
---------------	----

COLOR SYSTEM

Select SIGNAL from the "SET UP" menu during Video (S Video) input signal mode. ("SIGNAL [VIDEO]" menu is displayed.)

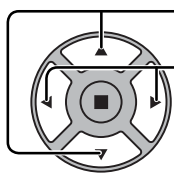

Press to select the "COLOR SYSTEM".

Press to select each function.

If the image becomes unstable:

With the system set on Auto, under conditions of low level or noisy input signals the image may in rare cases become unstable. Should this occur, set the system to match the format of the input signal.

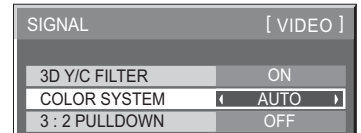

COLOR SYSTEM: Set the color system to match the input signal. When "AUTO" is set, COLOR SYSTEM will be automatically selected from NTSC/PAL/SECAM/NTSC 4.43/PAL M/PAL N.

To display PAL60 signal, select "AUTO".

→AUTO←→PAL←→SECAM←→NTSC←→NTSC 4.43←→PAL M←→PAL N←

3:2 PULLDOWN

3:2 PULLDOWN: When ON, the display attempts to reproduce a more natural interpretation of sources such as movie pictures, which are recorded at 24 frames per second. If the picture is not stable, turn the setting to OFF.

Note:

When ON, this setting only affects the following signal input:

- NTSC / PAL signal input during Video (S Video) input signal.
- 525i(480i), 625i(575i), 1125(1080)/60i signal input during Component input signal.

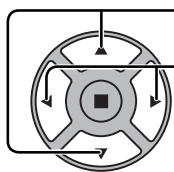

Press to select "3:2 PULLDOWN".

Press to set ON/OFF.



XGA MODE

This menu is displayed when the input signal is analog (Component/PC).

This menu sets two types of XGA signals with 60Hz vertical frequency having different aspect ratios and sampling rates (1,024 × 768 @ 60Hz and 1,366 × 768 @ 60Hz).

When a 1,280 × 768 @ 60Hz input signal is automatically detected, the image is processed as a 1,280 × 768 @ 60Hz XGA input signal irrespective of this setting.

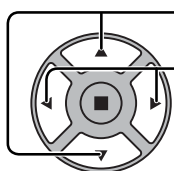

Press to select "XGA MODE".

Press to select "1024×768", "1366×768".



Note:

After making this setting, be sure to make each adjustment (such as "AUTO SETUP") on the "POS. /SIZE" menu as necessary. (see page 23)

SET UP for Input Signals

NOISE REDUCTION

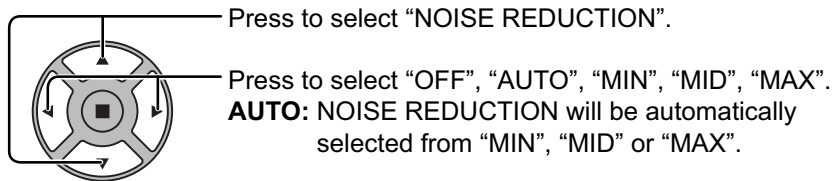

Note:

NOISE REDUCTION can be adjusted while a Video or Component signal is being applied.

SYNC

This function operates only during input from PC IN terminal.
Select SIGNAL from the "SET UP" menu during Component input signal.

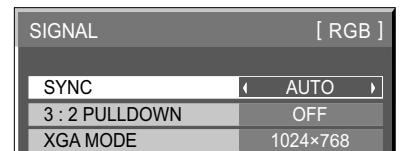
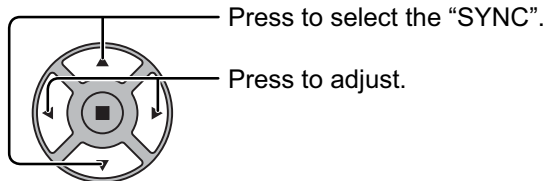

Confirm that the input is set to RGB input (this setting is valid only for RGB input signal).

AUTO: The H and V sync or synchronized signal is automatically selected. If both input, it is selected the H and V sync. However, the synchronized signal that is input first is selected.



ON G: Uses a synchronized signal on the Video G signal, which is input from the G connector.

Note:

Accepts only RGB signals from COMPONENT/RGB IN terminal with "SYNC ON G".

Input signal display

Displays the frequency and the type of the current input signal.

This display is valid only for COMPONENT/RGB/PC and Digital input signal.

Display range:

Horizontal 30 - 110 kHz

Vertical 48 - 120 Hz

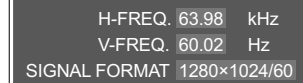

```
H-FREQ. 63.98 kHz
V-FREQ. 60.02 Hz
SIGNAL FORMAT 1280x1024/60
```

The dot clock frequency is displayed during digital signal input.

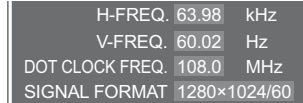



```
H-FREQ. 63.98 kHz
V-FREQ. 60.02 Hz
DOT CLOCK FREQ. 108.0 MHz
SIGNAL FORMAT 1280x1024/60
```

Note:

The automatically detected signal format may be displayed differently than the actual input signal.

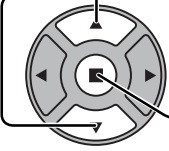
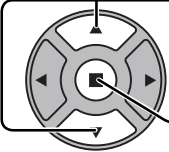
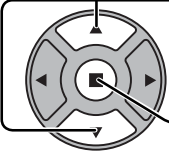
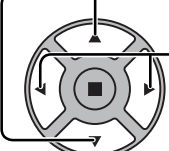
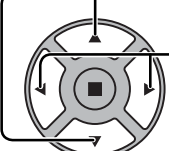
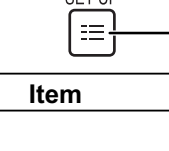



Options Adjustments

- 1  Press to display the SET UP menu.
- 2  Press to select "OSD LANGUAGE".
 Press for more than 3 seconds.
- 3  Press to select "Options".
 Press to display the Options menu.
- 4  Press to select your preferred menu.
 Press to adjust the menu.
- 5  Press to exit from Options menu.

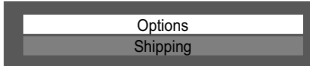























Options 1/2	
On screen display	◀ On ▶
Initial input	◀ Off ▶
Initial VOL level	◀ Off 0 ▶
Maximum VOL level	◀ Off 0 ▶
Input lock	◀ Off ▶
Button lock	◀ Off ▶
Remocon User level	◀ Off ▶

Options 2/2	
Off-timer function	◀ Enable ▶
Initial Power Mode	◀ Normal ▶
Power On Screen Delay	◀ Off ▶
Clock Display	◀ Off ▶
Power Switch Lock	◀ On ▶



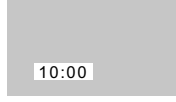

Item	Adjustments
On screen display	<p>On: Displays all the following on screen.</p> <ul style="list-style-type: none"> • Power on display • Input signal switch display • No signal display • Mute and the remaining time of off-timer after  was pressed. <p>Off: Hides all the items above from view.</p>
Initial input	<p>Adjusts the input signal when the unit is turned on.</p> <p>Off ↔ VIDEO ↔ Component/RGB ↔ PC ↔ DVI ↔ HDMI1 ↔ HDMI2 ↔ Off</p> <p>Notes:</p> <ul style="list-style-type: none"> • Only the adjusted signal is displayed. (see page 16) • This menu is available only when "Input lock" is "Off".
Initial VOL level	<p>Press   button to adjust the volume when the unit is turned on.</p> <p>Off ↔ On</p> <p>Off: Sets normal volume.</p> <p>On: Sets your preferred volume.</p> <p>Notes:</p> <ul style="list-style-type: none"> • When "Maximum VOL level" is "On", the volume can only be adjusted between 0 and your maximum range. • You can hear the changed volume regardless of your volume setting before opening the options menu if you adjust the volume when "Initial VOL level" is "On" and cursor is on the menu.
Maximum VOL level	<p>Press   button to adjust the maximum volume.</p> <p>Off ↔ On</p> <p>Off: Sets auto maximum volume.</p> <p>On: Sets your preferred maximum volume.</p> <p>Notes:</p> <ul style="list-style-type: none"> • If the "Maximum VOL level" is set lower than the "Initial VOL level", the "Initial VOL level" automatically becomes the same as the "Maximum VOL level". • The volume display can go up to 100 regardless of the settings. • You can hear the changed volume regardless of your volume setting before opening the options menu if you adjust the volume when "Maximum VOL level" is "On" and cursor is on the menu.
Input lock	<p>Locks the input switch operation.</p> <p>Off ↔ VIDEO ↔ Component/RGB ↔ PC ↔ DVI ↔ HDMI1 ↔ HDMI2 ↔ Off</p> <p>Notes:</p> <ul style="list-style-type: none"> • Only the adjusted signal is displayed (see page 16). • Input switch can be used when this is set to "Off".

Options Adjustments

Item	Adjustments
Button lock	<p>Off \leftrightarrow On \leftrightarrow MENU&ENTER</p> <p>Off: All the buttons on main unit can be used.</p> <p>MENU&ENTER: Locks  and  buttons on main unit.</p> <p>On: Locks all the button on main unit.</p> <p>Sets Button lock with the unit buttons in the following procedure.</p> <p>Off: Press  four times \rightarrow Press  four times \rightarrow Press  four times \rightarrow Press  </p> <p>MENU&ENTER: Press  four times \rightarrow Press  four times \rightarrow Press  four times \rightarrow Press  </p> <p>On: Press  four times \rightarrow Press  four times \rightarrow Press  four times \rightarrow Press  </p>
Remocon User level	<p>Off \leftrightarrow User1 \leftrightarrow User2 \leftrightarrow User3</p> <p>Off: You can use all of the buttons on the remote control.</p> <p>User1: You can only use , , , ,   buttons on the remote control.</p> <p>User2: You can only use  button on the remote control.</p> <p>User3: Locks all the buttons on remote control.</p>
Off-timer function	<p>Enable: Enables the "Off-timer function".</p> <p>Disable: Disables the "Off-timer function".</p> <p>Note: When "Disable" is set, the Off-timer is cancelled.</p>
Initial Power Mode	<p>Normal \leftrightarrow On \leftrightarrow Standby</p> <p>Sets the power mode of the unit for when the power recovers from failure or after plugging off and in again.</p> <p>Normal: Power returns in as the same state as before the power interruption.</p> <p>Standby: Power returns in standby mode. (Power Indicator : red/orange)</p> <p>On: Power returns in power On. (Power Indicator : green)</p> <p>Note: When using multiple displays, "Standby" is preferred to be set in order to reduce a power load.</p>
Power On Screen Delay	<p>Off \leftrightarrow 1 \leftrightarrow 2 \leftrightarrow 3... \leftrightarrow 30</p> <p>You can set the power-on delay time of the displays to reduce the power load, when you press POWER button to turn on the multiple displays that are set together, for example, on MULTI DISPLAY system.</p> <p>Set each display's setting individually.</p> <p>Off: The display will be turned on at the same time as POWER button is pressed.</p> <p>1 to 30 (sec.): Set the power-on delay time (second).</p> <p>After pressing POWER button, the display will be powered on with time delay depending on this setting.</p> <p>Notes:</p> <ul style="list-style-type: none"> • During this function is working, the power indicator is blinking green. • This function also works when the power recovers from failure or after plugging off and in again the power cord.
Clock Display	<p>Off: Not display the clock.</p> <p>On: Display the clock.</p> <p>The clock is displayed at the lower left of the screen when  button is pressed.</p> <div style="display: flex; align-items: center;">  <p>Note: When "PRESENT TIME SETUP" is not set, the clock is not displayed even if "Clock Display" is "On" (see page 28)</p> </div>
Power Switch Lock	<p>Sets the lock setting for the display Power switch.</p> <p>On: Power switch operation is disabled.</p> <p>Off: Power switch operation is enabled.</p>











Normalization

When both main unit buttons and remote control are disabled due to the "Button lock" or "Remocon User level" adjustments, set all the values "Off" so that all the buttons are enabled again.

Press the  button on main unit together with  button on the remote control and hold for more than 5 seconds. The "Shipping" menu is displayed and the lock is released when it disappears.

Troubleshooting

Before you call for service, determine the symptoms and make a few simple checks as shown below.

Symptoms		Checks
Picture	Sound	
 Interference	 Noisy Sound	Electrical Appliances Cars / Motorcycles Fluorescent light
 Normal Picture	 No Sound	Volume (Check whether the mute function has been activated on the remote control.)
 No Picture	 No Sound	Not plugged into AC outlet Not switched on PICTURE and BRIGHTNESS/Volume setting (Check by pressing the power switch or stand-by button on the remote control.)
 No Picture	 Normal Sound	If a signal with a non-applicable color system format, or frequency is input, only the input terminal indication is displayed.
 No Color	 Normal Sound	Color controls set at minimum level. (see page 25, 26) COLOR SYSTEM (see page 39)
No remote control operations can be performed.		Check whether the batteries have discharged completely and, if they have not, whether they were inserted properly. Check whether the remote control sensor is exposed to an outdoor light or a strong fluorescent light. Check whether the remote control designed specifically for use with the unit is being used. (The unit cannot be operated by any other remote control.)
A cracking sound is sometimes heard from the unit.		If there is nothing wrong with the picture or sound, this is the sound of the cabinet undergoing very slight contractions in response to changes in the room temperature. There are no adverse effects on the performance or other aspects.
The top or bottom of the picture on the screen is cut off when I use the zoom function.		Adjust the position of the picture on the screen.
Areas at the top and bottom of the screen where the image is missing appear when I use the zoom function.		When using a video software program (such as a cinema size program) with a screen wider than one in the 16:9 mode, blank areas separate from the images are formed at the top and bottom of the screen.
I can hear sounds coming from inside the unit.		When the power is turned on, a sound of the display panel being driven may be heard: This is normal and not indicative of malfunctioning.
Parts of the unit become hot.		Even when the temperature of parts of the front, top and rear panels has risen, these temperature rises will not pose any problems in terms of performance or quality.
Power automatically turns off unexpectedly.		Check the settings of "POWER MANAGEMENT" and "AUTO POWER OFF" in the SET UP menu. Any of them may be set to "ON". (see page 32)
This LCD Display uses special image processing. Hence a slight time lag may occur between image and audio, depending on the type of input signal. However, this is not a malfunction.		

LCD Display panel

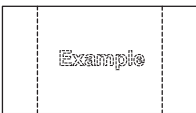
Symptoms	Check
The screen darkens slightly when bright pictures with minimal movements are shown.	The screen will darken slightly when photos, still images of a computer or other pictures with minimal movements are shown for an extended period. This is done to reduce image retention on the screen and the shortening of the screen's service life: It is normal and not indicative of malfunctioning.
It takes a while for the picture to appear.	The unit digitally processes the various signals in order to reproduce esthetically pleasing images. As such, it sometimes takes a few moments for the picture to appear when the power has been turned on, when the input has been switched.
The edges of the images flicker.	Due to the characteristics of the system used to drive the panel, the edges may appear to flicker in the fast-moving parts of the images: This is normal and not indicative of malfunctioning.
There may be red spots, blue spots, green spots and black spots on the screen.	This is a characteristic of liquid crystal panels and is not a problem. The liquid crystal panel is built with very high precision technology giving you fine picture details. Occasionally, a few non-active pixels may appear on the screen as fixed points of red, blue, green, or black. Please note this does not affect the performance of your LCD.
 <p>Image retention appears</p>	Image retention may occur. If you display a still picture for an extended period, the image might remain on the screen. However, it will disappear after a while. This is not considered as malfunction.

Applicable input signals

PC signals

*Mark: Applicable input signal

	Signal name	Horizontal frequency (kHz)	Vertical frequency (Hz)	RGB IN (Dot clock (MHz))	PC IN (Dot clock (MHz))	DVI-D IN (Dot clock (MHz))	HDMI1 HDMI2
1	640x400@70Hz	31.46	70.07	*(25.17)	*(25.17)	*(25.17)	
2	640x400@85Hz	37.86	85.08	*(31.5)	*(31.5)	*(31.5)	
3	640x480@60Hz	31.43	59.88	*(25.15)	*(25.15)	*(25.15)	
4	640x480@60Hz	31.47	59.94	*(25.18)	*(25.18)	*(25.18)	*
5	640x480@67Hz	35.00	66.67	*(30.24)	*(30.24)	*(30.24)	
6	640x480@72Hz	37.86	72.81	*(31.5)	*(31.5)	*(31.5)	
7	640x480@75Hz	37.50	75.00	*(31.5)	*(31.5)	*(31.5)	
8	640x480@85Hz	43.27	85.01	*(36.0)	*(36.0)	*(36.0)	
9	720x400@70Hz	31.47	70.08	*(28.32)	*(28.32)	*(28.32)	
10	800x600@55Hz	34.50	55.38	*(35.33)	*(35.33)	*(35.33)	
11	800x600@56Hz	35.16	56.25	*(36.0)	*(36.0)	*(36.0)	
12	800x600@60Hz	37.88	60.32	*(40.0)	*(40.0)	*(40.0)	*
13	800x600@60Hz	38.00	60.51	*(40.13)	*(40.13)	*(40.13)	
14	800x600@72Hz	48.08	72.19	*(50.0)	*(50.0)	*(50.0)	
15	800x600@75Hz	46.88	75.00	*(49.5)	*(49.5)	*(49.5)	
16	800x600@85Hz	53.67	85.06	*(56.25)	*(56.25)	*(56.25)	
17	852x480@60Hz	31.47	59.94	*(33.54)	*(33.54)	*(34.24)	
18	1,024x768@50Hz	39.55	50.00	*(51.89)	*(51.89)	*(51.89)	
19	1,024x768@60Hz	48.36	60.00	*(65.0)	*(65.0)	*(65.0)	*
20	1,024x768@60Hz	48.50	60.02	*(64.99)	*(64.99)	*(65.18)	
21	1,024x768@70Hz	56.48	70.07	*(75.0)	*(75.0)	*(75.0)	
22	1,024x768@75Hz	60.24	74.93	*(80.0)	*(80.0)	*(80.0)	
23	1,024x768@75Hz	60.02	75.03	*(78.75)	*(78.75)	*(78.75)	
24	1,024x768@75Hz	61.01	75.70	*(80.05)	*(80.05)	*(81.0)	
25	1,024x768@85Hz	68.68	85.00	*(94.5)	*(94.5)	*(94.5)	
26	1,024x768@120Hz	97.55	119.99	*(115.5)	*(115.5)	*(115.5)	
27	1,066x600@60Hz	37.64	59.94	*(53.0)	*(53.0)	*(53.0)	
28	1,152x864@60Hz	53.70	60.00	*(81.62)	*(81.62)	*(81.62)	
29	1,152x864@75Hz	67.50	75.00	*(108.0)	*(108.0)	*(108.0)	
30	1,152x900@65Hz	61.20	65.20	*(92.0)	*(92.0)	*(92.0)	
31	1,152x900@66Hz	61.85	66.00	*(94.5)	*(94.5)	*(94.5)	
32	1,152x900@75Hz	71.40	75.60	*(105.1)	*(105.1)	*(105.1)	
33	1,280x768@60Hz	47.78	59.87	*(79.50)	*(79.50)	*(79.50)	
34	1,280x800@50Hz	41.20	50.00	*(68.55)	*(68.55)	*(68.55)	
35	1,280x960@60Hz	60.00	60.00	*(108.0)	*(108.0)	*(108.0)	
36	1,280x960@85Hz	85.94	85.00	*(148.5)	*(148.5)	*(148.5)	
37	1,280x1,024@50Hz	52.70	50.00	*(89.38)	*(89.38)	*(89.38)	
38	1,280x1,024@60Hz	63.34	59.98	*(108.18)	*(108.18)	*(108.18)	
39	1,280x1,024@60Hz	63.90	60.00	*(107.35)	*(107.35)	*(107.35)	
40	1,280x1,024@60Hz	63.37	60.01	*(107.5)	*(107.5)	*(107.5)	
41	1,280x1,024@60Hz	63.74	60.02	*(108.1)	*(108.1)	*(108.1)	
42	1,280x1,024@60Hz	63.98	60.02	*(108.0)	*(108.0)	*(108.0)	*
43	1,280x1,024@60Hz	63.79	60.18	*(108.19)	*(108.19)	*(108.19)	
44	1,280x1,024@66Hz	70.66	66.47	*(119.84)	*(119.84)	*(119.84)	
45	1,280x1,024@75Hz	79.98	75.02	*(135.0)	*(135.0)	*(135.0)	
46	1,280x1,024@76Hz	81.13	76.11	*(135.0)	*(135.0)	*(135.0)	
47	1,280x1,024@85Hz	91.15	85.02	*(157.5)	*(157.5)	*(157.5)	
48	1,366x768@60Hz	47.71	60.02	*(85.5)	*(85.5)	*(85.5)	
49	1,366x768@50Hz	39.55	50.00	*(69.92)	*(69.92)	*(69.92)	
50	1,366x768@60Hz	48.36	60.00	*(86.71)	*(86.71)	*(87.44)	
51	1,400x1,050@60Hz	65.12	59.91	*(121.38)	*(121.38)	*(122.43)	
52	1,400x1,050@60Hz	65.32	59.98	*(121.75)	*(121.75)	*(121.75)	
53	1,400x1,050@60Hz	65.35	60.12	*(121.81)	*(121.81)	*(121.85)	
54	1,400x1,050@75Hz	82.28	74.87	*(156.0)	*(156.0)	*(156.0)	
55	1,600x1,200@60Hz	75.00	60.00	*(162.0)	*(162.0)	*(162.0)	
56	1,920x1,080@60Hz	67.50	60.00	*(148.5)	*(148.5)	*(148.5)	
57	1,920x1,200@60Hz	74.04	59.95	*(154.0)	*(154.0)	*(154.0)	
58	Macintosh13" (640x480)	35.00	66.67	*(30.24)	*(30.24)	*(30.24)	
59	MacintoshLC13" (640x480)	34.97	66.60	*(31.33)	*(31.33)	*(31.33)	
60	Macintosh16" (832x624)	49.72	74.55	*(57.28)	*(57.28)	*(57.28)	
61	Macintosh19" (1,024x768)	60.24	75.08	*(80.0)	*(80.0)	*(80.0)	
62	Macintosh21" (1,152x870)	68.68	75.06	*(100.0)	*(100.0)	*(100.0)	
63	Macintosh II (1,280x1,024)	80.00	75.00	*(134.4)	*(134.4)	*(135.2)	

Applicable input signals

Component signals

*Mark: Applicable input signal

	Signal name	Horizontal frequency (kHz)	Vertical frequency (Hz)	COMPONENT IN (Dot clock (MHz))	DVI-D IN (Dot clock (MHz))	HDMI1 HDMI2
1	525(480)/60i	15.73	59.94	* (13.5)	* (27.0)	*
2	525(480)/60p	31.47	59.94	* (27.0)	* (27.0)	*
3	625(575)/50i	15.63	50.00	* (13.5)		
4	625(576)/50i	15.63	50.00		* (27.0)	*
5	625(575)/50p	31.25	50.00	* (27.0)		*
6	625(576)/50p	31.25	50.00		* (27.0)	*
7	750(720)/60p	45.00	60.00	* (74.25)	* (74.25)	*
8	750(720)/50p	37.50	50.00	* (74.25)	* (74.25)	*
9	1,125(1,080)/60p	67.50	60.00	* (148.5)*1	* (148.5)	*
10	1,125(1,080)/60i	33.75	60.00	* (74.25)*1	* (74.25)	*
11	1,125(1,080)/50p	56.25	50.00	* (148.5)*1	* (148.5)	*
12	1,125(1,080)/50i	28.13	50.00	* (74.25)*1	* (74.25)	*
13	1,125(1,080)/24sF	27.00	48.00	* (74.25)*2		
14	1,125(1,080)/30p	33.75	30.00	* (74.25)*1	* (74.25)	*
15	1,125(1,080)/25p	28.13	25.00	* (74.25)*1	* (74.25)	*
16	1,125(1,080)/24p	27.00	24.00	* (74.25)*1	* (74.25)	*

*1: Based on SMPTE 274M standard. *2: Based on SMPTE RP211 standard.

Video signals (VIDEO, S-VIDEO)

	Signal name	Horizontal frequency (kHz)	Vertical frequency (Hz)
1	NTSC	15.73	59.94
2	PAL	15.63	50.00
3	PAL60	15.73	59.94
4	SECAM	15.63	50.00
5	NTSC 4.43	15.73	59.94
6	PAL N	15.63	50.00
7	PAL M	15.73	59.94

Shipping condition

This function allows you to reset the unit to the factory setting.

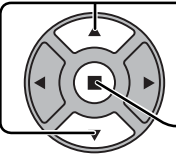
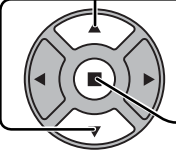
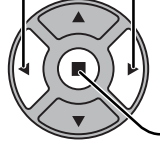
- 1  Press to display the SET UP menu.
- 2  Press to select "OSD LANGUAGE".
Press for more than 3 seconds.
- 3  Press to select "Shipping".
Press to display the Shipping menu.
- 4  Press to select "YES".
Press to confirm.

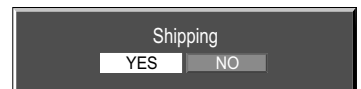
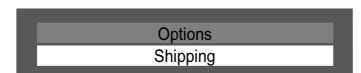
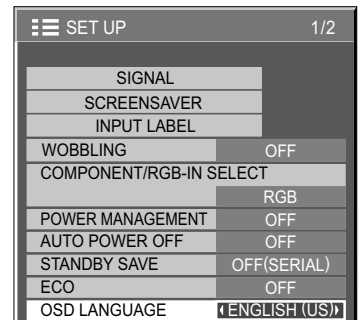

[from the unit]

- 1 Press the MENU button till the SET UP menu is displayed.
- 2 Press the Volume Up "+" or Down "-" button to select "OSD LANGUAGE".
- 3 Press and hold the ENTER button till the Shipping menu is displayed.
- 4 Press the Volume Up "+" or Down "-" button to select "YES".
- 5 Press the ENTER button and wait for 10 sec.

Specifications

	TH-42LF20U	TH-47LF20U
Power Source	110 - 127 V AC, 50/60 Hz	
Power Consumption		
Rated Power Consumption	250 W	300 W
On mode Average Power Consumption*	200 W	255 W
Stand-by condition	0.1 W	0.1 W
LCD Display panel	42-inch IPS panel, 16:9 aspect ratio	47-inch IPS panel, 16:9 aspect ratio
Screen size	36.6" (930 mm) (W) × 20.5" (523 mm) (H) × 42.0" (1,067 mm) (diagonal)	40.9" (1,040 mm) (W) × 23.0" (585 mm) (H) × 46.9" (1,193 mm) (diagonal)
(No. of pixels)	2,073,600 (1,920 (W) × 1,080 (H)) [5,760 × 1,080 dots]	2,073,600 (1,920 (W) × 1,080 (H)) [5,760 × 1,080 dots]
Operating condition		
Temperature	32 °F - 104 °F (0 °C - 40 °C)	32 °F - 104 °F (0 °C - 40 °C)
Humidity	20 % - 80 %	20 % - 80 %
Applicable signals		
Color System	NTSC, PAL, PAL60, SECAM, NTSC 4.43, PAL M, PAL N	
Scanning format	525 (480) / 60i · 60p, 625 (575) / 50i · 50p, 750 (720) / 60p · 50p, 1125 (1080) / 60i · 60p · 50i · 50p · 24p · 25p · 30p · 24sF, 1250 (1080) / 50i	
PC signals	VGA, SVGA, XGA, SXGA UXGA ··· (compressed) Horizontal scanning frequency 30 - 110 kHz Vertical scanning frequency 48 - 120 Hz	
Connection terminals		
AV IN	VIDEO S-VIDEO AUDIO L-R	BNC Mini DIN 4PIN RCA Pin jack × 2 1.0 Vp-p (75 Ω) Y: 1.0 Vp-p (75 Ω), C: 0.286 Vp-p (75 Ω) 0.5 Vrms
HDMI 1/2		TYPE A Connector × 2
COMPONENT/RGB IN	G/Y B/Pb/Cb R/Pr/Cr AUDIO L-R	BNC BNC BNC RCA Pin jack × 2 with sync 1.0 Vp-p (75 Ω) 0.7 Vp-p (75 Ω) 0.7 Vp-p (75 Ω) 0.5 Vrms
DVI-D IN	AUDIO	DVI-D 24 Pin Content Protection Stereo mini jack (M3) × 1 Compliance with DVI Revision 1.0 Compatible with HDCP 1.1 0.5 Vrms, Shared with PC IN
PC IN	AUDIO	High-Density Mini D-sub 15 Pin Stereo mini jack (M3) × 1 G with sync 1.0 Vp-p (75 Ω) G without sync 0.7 Vp-p (75 Ω) B: 0.7 Vp-p (75 Ω) R: 0.7 Vp-p (75 Ω) HD/VD: 1.0 - 5.0 Vp-p (high impedance) 0.5 Vrms, Shared with DVI-D IN
SERIAL		External Control Terminal D-sub 9 Pin RS-232C compatible
Sound		
Speakers	2.0" (50 mm) × 3.6" (90 mm) × 2 pcs	
Audio Output	10 W [5 W + 5 W] (10 % THD)	
Dimensions (W × H × D)	38.2" (968 mm) × 22.1" (561 mm) × 4.0" (101 mm)	42.5" (1,079 mm) × 24.6" (624 mm) × 4.0" (101 mm)
Mass (weight)	approx. 39.7 lbs	approx. 50.7 lbs

* Based on IEC 62087 Ed.2 section 11.6.1 measurement method.

Note:

Design and specifications are subject to change without notice. Mass and dimensions shown are approximate.

This product has a fluorescent lamp that contains mercury.
Disposal may be regulated in your community due to environmental considerations.
For disposal or recycling information, please contact your local authorities, or the
Electronic Industries Alliance:
<http://www.eiae.org>.

Customer's Record

The model number and serial number of this product can be found on its back cover. You should note this serial number in the space provided below and retain this book, plus your purchase receipt, as a permanent record of your purchase to aid in identification in the event of theft or loss, and for Warranty Service purposes.

Model Number _____

Serial Number _____

© Panasonic Corporation 2010

Panasonic Solutions Company

Unit of Panasonic Corporation of North America

Executive Office :

Three Panasonic Way 2F-5, Secaucus, NJ 07094

Panasonic Canada Inc.

5770 Ambler Drive
Mississauga, Ontario
L4W 2T3