

Aputure®

**Amaran**

Perfect LED Lighting Solution

“艾蒙拉” LED摄影灯

**AL-H198C**  
User Manual



**Description**

Aputure Amaran LED Video Light is the perfect lighting for your HDSLR or video camera. It is made of 198 lamp beads which have up to 95 CRI value, ensuring a faithful production of colors in the shoot. Color temperature can be adjusted with AL-H198C. You can also adjust the brightness to your need with flicker free output, or expand the LED light for your needed brightness. It supports various lithium batteries. The indicator will display the state of battery. You can shoot amazing images or videos with high efficiency Amaran AL-H198C in ease.

**Main Features**

1. Color temperatures adjustable
2. Brightness adjustable
3. Battery power indicator
4. Expandable up to 9 LED panels
5. High-quality LED beads, long lifespan
6. Multiple battery options
7. 16:9 widescreen design
8. Low power consumption, eco-friendly & power saving
9. Lightweight, portable and compact

- 1 -

**Components**

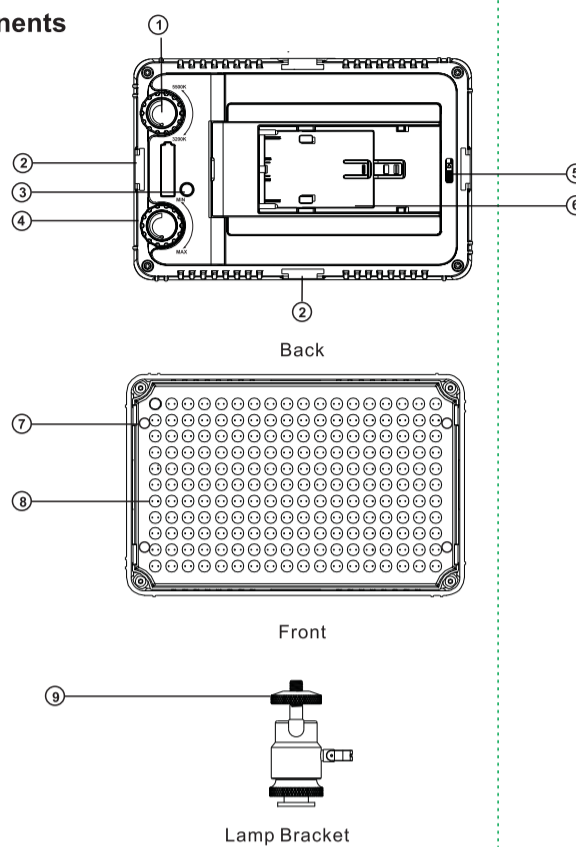

- 2 -

- ① Color Temperature Adjustment Wheel
- ② Extension Slot
- ③ Test Button
- ④ Brightness Adjustment Wheel
- ⑤ Battery Latch
- ⑥ Lithium Battery Slot
- ⑦ Filter Column
- ⑧ Lamp Beads
- ⑨ Locking Knob
- ⑩ Filter Slot
- ⑪ White Filter
- ⑫ Extension Attachment

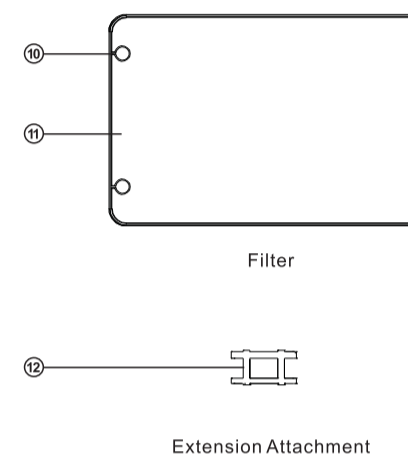

- 3 -

**Battery Installation**

**AA Battery Installation**

Insert six AA batteries into the battery holder by following the diagram's directions.

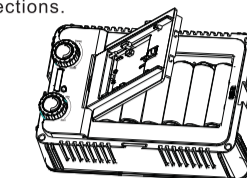

Tips: When installing batteries, please notice the Positive and Negative icon. We suggest use rechargeable AA batteries.

**Lithium Battery Installation**

Insert lithium battery by following the diagram's directions, then push the battery holder to the left.

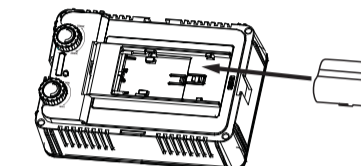

Tips: Usable lithium batteries include Sony NP-F series: NP-F550/F570/F770/F960/F970; NP-FM/QM series: FM50/FM51/FM55H/FM500H/QM50/QM51/QM71D/QM91D; NP-FP/FH/FV series: NP-FP50/FP60/FP70/FP90/FH50/FH60/FH70/FH90/FH100/FV50/FV60/FV70/FV100.

Please do not mix lithium battery with AA batteries to avoid serious injury or damage from exploding, leaking or cause firing and even death.

- 4 -

**Installation and Removal**

**Installation**

Please fix the hot-shoe head of Lamp Bracket to the Extension Slot of LED's bottom, and turn the Locking Knob to the right.

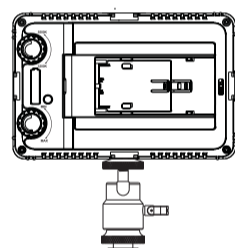

**Removal**

Turn the locking knob to the left, and take the hot shoe head out from the Extension Slot of LED's bottom.

Note: Turn off the light before video light installation or removal.

**Function and Operation**

**1. Brightness Control**

Aputure Amaran LED Video Light can control the level of brightness by rotating the Brightness Adjustment Wheel. Turn to the right to increase brightness, conversely, left to decrease.

- 5 -

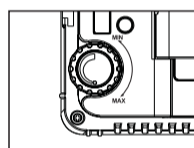

**2. Color Temperature Control**

AL-H198C can control Color temperatures by rotating the Color Temperature Adjustment Wheel. Turn to the right to decrease the Color temperature, ranging from 5500K to 3200K.

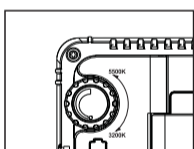

**3. Battery Power Test**

There are four indicators on the back of the LED. Remember to turn off the LED light when pressing the test button.

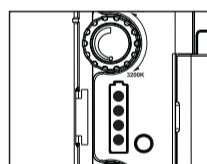

- 6 -

Tips: When using lithium batteries, full power is indicated by two or three indicator lights (because of the lower voltage compared to 6 AA batteries)

**4. Multiple Light Combinations**

There are 4 Extension Slots on the four sides of Aputure Amaran LED video light, the user can combine the lights together to get your wanted brightness.

**4.1 Horizontal Extension**

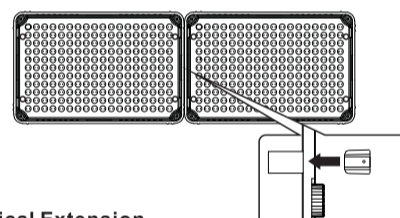

**4.2 Vertical Extension**

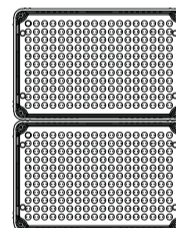

- 7 -

**4.3 Vertical and Horizontal Extension**

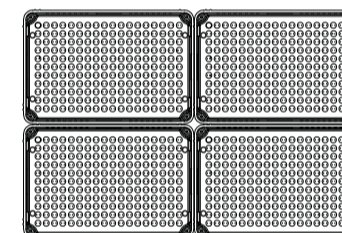

Tips: The horizontal or vertical extension is limited to three by three (3x3) squares. Overloading may affect stability and compromise your LED lights safety.

**Specifications**

Operating Current	< 1A	Power	< 10W
Supply Power	DC 5.5V-9.5V	Cooling Mode	Natural Ventilation
Average Life Span(H)	> 100000	Color Temperature	5500K-3200K
Beam Angle	60°	CRI	> 95 Ra
Volume(L*W*H mm)	151x56x100mm	Net Weight	325g

**Brightness**

Beads	Footcandles			LUX			
	0.5m	1m	2m	0.5m	1m	2m	
60°	5500K	165	40	11	1780	435	115
	3200K	156	39	10	1690	420	110

- 8 -

**Notes**

1. Please do not directly face the LED when the lights are on.
2. Never block the ventilation grille by covering it with paper or clothes.
3. Do not place the LED light near alcohol or other flammable objects.
4. Do not place any objects or liquids on the LED light.
5. When the LED light is on or against the other items above, please turn it off, lest they cause fire or damage to the light.
6. Do not grab the LED light head to pick up your camera, when they are attached.
7. Use a dry soft cloth to clean the LED light. You can clean the device with a cloth slightly some neutral detergent to remove the dirt. Do not use strong cleaning agents, such as thinner, gasoline or alcohol.

**Safety Precautions**

1. To prevent fire or electric shock, please keep the device away from rain or humidity.
2. Should you notice smoke or an unusual temperature coming from the equipment, cut off the power and stop using it. Take the device to an authorized service center for inspection.
3. Do not disassemble the device by yourself. In the event of malfunction, the product should be repaired only by a qualified technician or service center.
4. During storage and transportation, please turn the device off.
5. Please use the appropriate lithium battery for the device.
6. Keep the device out of reach of children.

- 9 -

## AL-H198C

### 使用说明书



#### 描述

爱图仕Amaran LED灯，为您解决拍摄时光线不足影响拍摄的难题。AL-H198C由精选的显色指数达到95以上的198颗灯珠组成，颜色显示更真实。AL-H198C可调节LED灯的色温。同时，您可以根据需要手动调整LED灯的光亮度，或者选择双灯、多灯拼接达到不同拍摄效果。此灯支持多种类型电池，支持电量查看。Amaran AL-H198C简单、易用、高效能，是您视频拍摄的最佳拍档。

#### 主要特点

1. 采用高显色性LED灯珠，显色指数 > Ra95 (CRI > 95)，还原更真实的颜色。
2. 色温调节功能。
3. 调节光亮度功能。
4. 支持电量查看。
5. 可多灯拼接达到不同的光亮度。
6. 精选优质灯珠，超长使用寿命。
7. 可使用多种类型的电池。
8. 16:9宽屏比例设计。
9. 低功耗，超强节能，绿色环保。

- 1 -

#### 各部件名称

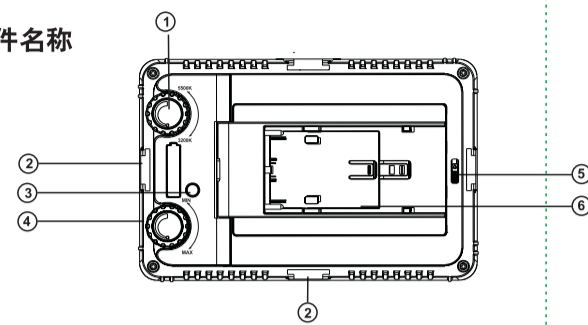

灯具后视图

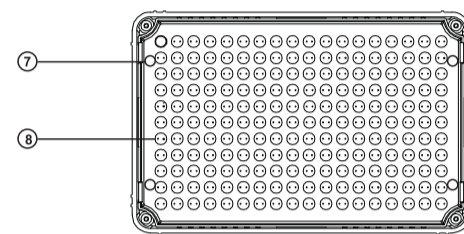

灯具前视图



灯具支撑柱

- 2 -

- ① 色温调节按钮
- ② 组合插槽
- ③ 电池电量测试按钮
- ④ 调光旋钮
- ⑤ 电池仓盖锁扣
- ⑥ 锂电池仓
- ⑦ 滤光片卡柱
- ⑧ LED灯珠
- ⑨ 锁紧旋钮
- ⑩ 卡孔
- ⑪ 白色色片
- ⑫ 组合插槽连接附件

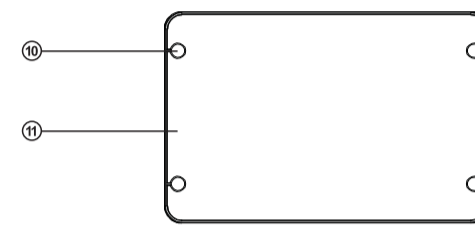

色片



组合插槽连接附件

- 3 -

#### 电池安装

##### AA电池安装

将6节AA电池按图示方向装入电池仓中。

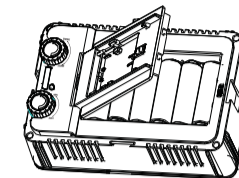

小贴士：建议使用可充电电池。使用时请注意电池正、负极，新旧电池不能混合装入。

##### 锂电池安装

将锂电池按图示方向下压，然后向左推入电池盒。

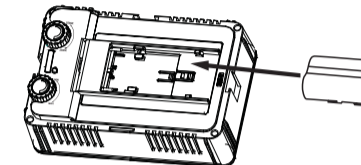

小贴士：适用电池型号为索尼NP-F系列：NP-F550/F570/F770/F960/F970；NP-FM/QM系列：FM50/FM51/FM55H/FM500H/QM50/QM51/QM71D/QM91D；NP-FP/FH/FV系列：NP-FP50/FP60/FP70/FP90/FH50/FH60/FH70/FH90/FH100/FV50/FV60/FV70/FV100。

⚠ 请勿同时使用AA电池和锂电池。违反此警告可能引起爆炸或火灾，甚至危及人身安全。

- 4 -

#### 安装与拆卸

##### 安装

将灯具支撑柱的热靴头插入LED摄影灯底部的组合插槽，向右旋转锁紧旋钮即可。

##### 拆卸

向左旋转锁紧旋钮，从LED摄影灯底部的组合插槽中拔出灯具支撑柱的热靴头即可。

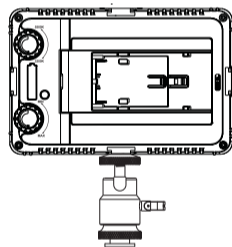

小贴士：在将摄影灯安装到摄像机或从摄像机卸下摄影灯之前，须先把电源开关关掉。

#### 功能与操作

##### 1. 亮度调节

爱图仕Amaran LED摄影灯具有调节亮度的功能。

如图所示：

向右旋转调光旋钮，LED摄影灯将会被打开，继续向右旋转该旋钮，亮度增强；反之，亮度减弱，直至LED摄影灯关闭。

- 5 -

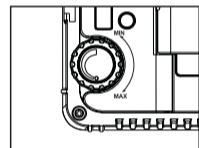

##### 2. 色温调节

AL-H198C具有可调节色温功能。打开调光旋钮，LED摄影灯亮起；向右旋转色温调节旋钮，色温从5500K逐渐变为3200K，颜色则由白色渐变为橙色。

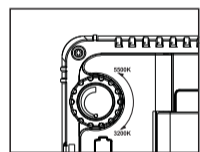

##### 3. 电池电量测试

爱图仕Amaran LED摄影灯背部有四个指示灯，只需按下下方的电池电量测试按钮即可测试电池电量。测试电量时，请关闭LED灯。

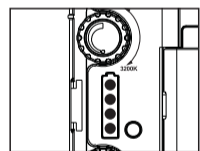

- 6 -

小贴士：由于锂电池的电压小于AA电池的电压，所以当使用锂电池进行电量测试时，即使其处于饱和状态，正常状况下只有2至3个指示灯亮起。

#### 4. 多灯拼装

爱图仕Amaran LED摄影灯的四个方向均有组合插槽，可通过组合插槽连接附件将多个摄影灯拼接起来达到既定的摄影摄像效果。

##### 4.1 横向拼接

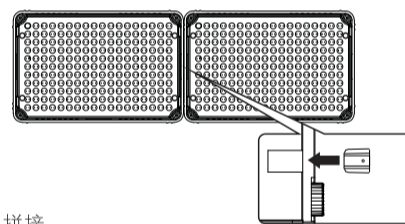

##### 4.2 纵向拼接

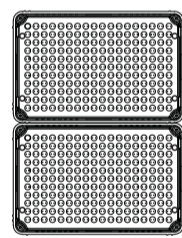

- 7 -

#### 4.3 纵横拼接

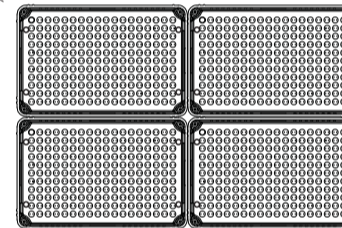

小贴士：横向组合或纵向组合以三台为限，即3X3的方阵，超过时有可能影响稳定性。

#### 规格

工作电流	<1A	功耗	<10W
工作电压	DC 5.5V-9.5V	散热方式	自然通风
平均寿命(小时)	>100000	色温	5500K-3200K
光照角度	60°	CRI	>95 Ra
体积(长X宽X高)	151x56x100mm	净重	325g

#### 亮度测试数据

灯珠	英尺烛光 (ftc)			勒克斯 (Lux)			
	0.5m	1m	2m	0.5m	1m	2m	
60°	5500K	165	40	11	1780	435	115
	3200K	156	39	10	1690	420	110

- 8 -

#### 注意事项

1. 当摄影灯点亮时，切勿直视。
2. 在使用过程中，散热口上切勿有遮盖物以免影响散热效果而损毁设备。
3. 避免将摄影灯放置在如酒精或汽油等易燃或易挥发的溶剂附近。
4. 切勿将任何物体置于摄影灯上或使液体掉入其内部。
5. 当摄影灯放在或靠在其他物品上时，请关掉摄影灯，否则有可能会造成火灾或损坏摄影灯。
6. 切勿抓住摄影灯的灯头拿起摄影机。
7. 当清洁摄影灯时，请选用干软布沾上中性的清洁剂将其污垢擦去，切忌使用烈性的清洁剂，如稀释剂、汽油或酒精等。

#### 安全须知

1. 切勿让本装置遭雨淋或受潮，以免火灾或触电的发生。
2. 请使用规定的电池，以便安全使用。
3. 使用中若发现温度异常或冒烟现象，应立即切断电源，停止使用，并送到授权经销商予以合理的处理。
4. 当遇到任何故障时，请勿自行拆卸设备，应联系有资格的维修技师或服务中心进行检查维修。
5. 储运过程中，请断开设备和电源，以免误触开关后，长时间的无人监控引起火灾的发生。
6. 请安全选购和使用适用于本设备的电池。
7. 请保管好本产品，切勿放置在儿童伸手之处。

- 9 -

## Aputure® 深圳市爱图仕影像器材有限公司

设计项目	AL-H198C LED摄影灯AL-H198C 说明书	图号	AP-H198C-PR-02
尺寸(mm)	展开尺寸：430*258mm，折叠尺寸：86*129MM	版本	A1版
材质工艺	单黑, 70克书写纸, 红色虚线为折痕线	设计师	杨萍
		日期	2014年6月6日
备注	料号：516BH198C010，英文在前。		