

Panasonic®

Operating Instructions

Digital Camera/
Lens Kit/Body

Model No. **DMC-GH2H/DMC-GH2K**
DMC-GH2



Before use, please read these instructions completely.

Web Site: <http://www.panasonic-europe.com>

Model number suffix "EB" denotes UK model.



VQT3A48

Dear Customer,

We would like to take this opportunity to thank you for purchasing this Panasonic Digital Camera. Please read these Operating Instructions carefully and keep them handy for future reference. Please note that the actual controls and components, menu items, etc. of your Digital Camera may look somewhat different from those shown in the illustrations in these Operating Instructions.

Carefully observe copyright laws.

- Recording of pre-recorded tapes or discs or other published or broadcast material for purposes other than your own private use may infringe copyright laws. Even for the purpose of private use, recording of certain material may be restricted.

Information for Your Safety

WARNING:

- TO REDUCE THE RISK OF FIRE, ELECTRIC SHOCK OR PRODUCT DAMAGE,**
- **DO NOT EXPOSE THIS APPARATUS TO RAIN, MOISTURE, DRIPPING OR SPLASHING AND THAT NO OBJECTS FILLED WITH LIQUIDS, SUCH AS VASES, SHALL BE PLACED ON THE APPARATUS.**
 - **USE ONLY THE RECOMMENDED ACCESSORIES.**
 - **DO NOT REMOVE THE COVER (OR BACK); THERE ARE NO USER SERVICEABLE PARTS INSIDE. REFER SERVICING TO QUALIFIED SERVICE PERSONNEL.**

THE SOCKET OUTLET SHALL BE INSTALLED NEAR THE EQUIPMENT AND SHALL BE EASILY ACCESSIBLE.

■ Product identification marking

Product	Location
Digital camera	Bottom
Battery charger	Bottom

■ About the battery pack**CAUTION**

Danger of explosion if battery is incorrectly replaced. Replace only with the same or equivalent type recommended by the manufacturer. Dispose of used batteries according to the manufacturer's instructions.

- Do not heat or expose to flame.
- Do not leave the battery(ies) in an automobile exposed to direct sunlight for a long period of time with doors and windows closed.



Warning

Risk of fire, explosion and burns. Do not disassemble, heat above 60 °C or incinerate.

Caution for AC mains lead

For your safety, please read the following text carefully.

This appliance is supplied with a moulded three pin mains plug for your safety and convenience.

A 5-ampere fuse is fitted in this plug. Should the fuse need to be replaced please ensure that the replacement fuse has a rating of 5-ampere and that it is approved by ASTA or BSI to BS1362. Check for the ASTA mark  or the BSI mark  on the body of the fuse.

If the plug contains a removable fuse cover you must ensure that it is refitted when the fuse is replaced.

If you lose the fuse cover the plug must not be used until a replacement cover is obtained.

A replacement fuse cover can be purchased from your local dealer.

CAUTION!

IF THE FITTED MOULDED PLUG IS UNSUITABLE FOR THE SOCKET OUTLET IN YOUR HOME THEN THE FUSE SHOULD BE REMOVED AND THE PLUG CUT OFF AND DISPOSED OF SAFELY.

THERE IS A DANGER OF SEVERE ELECTRICAL SHOCK IF THE CUT OFF PLUG IS INSERTED INTO ANY 13- AMPERE SOCKET.

If a new plug is to be fitted please observe the wiring code as stated below. If in any doubt please consult a qualified electrician.

■ IMPORTANT

The wires in this mains lead are coloured in accordance with the following code:

Blue: Neutral, Brown: Live.

As these colours may not correspond with the coloured markings identifying the terminals in your plug, proceed as follows: The wire which is coloured Blue must be connected to the terminal which is marked with the letter N or coloured Black or Blue. The wire which is coloured Brown must be connected to the terminal which is marked with the letter L or coloured Brown or Red.

WARNING: DO NOT CONNECT EITHER WIRE TO THE EARTH TERMINAL WHICH IS MARKED WITH THE LETTER E, BY THE EARTH SYMBOL \perp OR COLOURED GREEN OR GREEN/YELLOW.

THIS PLUG IS NOT WATERPROOF—KEEP DRY.

■ Before use

Remove the connector cover.

■ How to replace the fuse

The location of the fuse differ according to the type of AC mains plug (figures A and B). Confirm the AC mains plug fitted and follow the instructions below.

Illustrations may differ from actual AC mains plug.

1. Open the fuse cover with a screwdriver.

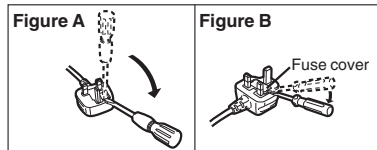

2. Replace the fuse and close or attach the fuse cover.

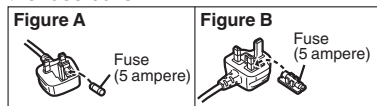

■ About the battery charger

CAUTION!

- **DO NOT INSTALL OR PLACE THIS UNIT IN A BOOKCASE, BUILT-IN CABINET OR IN ANOTHER CONFINED SPACE. ENSURE THE UNIT IS WELL VENTILATED. TO PREVENT RISK OF ELECTRIC SHOCK OR FIRE HAZARD DUE TO OVERHEATING, ENSURE THAT CURTAINS AND ANY OTHER MATERIALS DO NOT OBSTRUCT THE VENTILATION VENTS.**
- **DO NOT OBSTRUCT THE UNIT'S VENTILATION OPENINGS WITH NEWSPAPERS, TABLECLOTHS, CURTAINS, AND SIMILAR ITEMS.**
- **DO NOT PLACE SOURCES OF NAKED FLAMES, SUCH AS LIGHTED CANDLES, ON THE UNIT.**
- **DISPOSE OF BATTERIES IN AN ENVIRONMENTALLY FRIENDLY MANNER.**

- The battery charger is in the standby condition when the AC power supply cord is connected. The primary circuit is always "live" as long as the power cord is connected to an electrical outlet.

■ Care of the camera

- **Do not strongly shake or bump the camera by dropping or hitting it. Do not subject to strong pressure.**

The camera may malfunction, recording pictures may become impossible, or the lens, the LCD monitor or the external case may be damaged.

- **Be particularly careful in the following places as they may cause this unit to malfunction.**

– Places with a lot of sand or dust.

– Places where water can come into contact with this unit such as when using it on a rainy day or on a beach.

- **Do not touch the lens or the sockets with dirty hands. Also, be careful not to allow liquids, sand and other foreign matter to get into the space around the lens, buttons etc.**
- **This camera is not waterproof. If water or seawater splashes on the camera, use a dry cloth to wipe the camera body carefully.**

If the unit does not operate normally, please contact the dealer where you purchased the camera or the repair service centre.

- **Do not place your hands inside the mount of the digital camera body. Since the sensor unit is a precision apparatus, it may cause a malfunction or damage.**

■ About Condensation (When the lens, the viewfinder or LCD Monitor is fogged up)

- Condensation occurs when the ambient temperature or humidity changes. Be careful of condensation since it causes lens and LCD monitor stains, fungus and camera malfunction.
- If condensation occurs, turn the camera off and leave it for about 2 hours. The fog will disappear naturally when the temperature of the camera becomes close to the ambient temperature.

■ Read together with the "Cautions for Use". (P177)

Information for Users on Collection and Disposal of Old Equipment and used Batteries



These symbols on the products, packaging, and/or accompanying documents mean that used electrical and electronic products and batteries should not be mixed with general household waste. For proper treatment, recovery and recycling of old products and used batteries, please take them to applicable collection points, in accordance with your national legislation and the Directives 2002/96/EC and 2006/66/EC.

By disposing of these products and batteries correctly, you will help to save valuable resources and prevent any potential negative effects on human health and the environment which could otherwise arise from inappropriate waste handling.

For more information about collection and recycling of old products and batteries, please contact your local municipality, your waste disposal service or the point of sale where you purchased the items.

Penalties may be applicable for incorrect disposal of this waste, in accordance with national legislation.



For business users in the European Union

If you wish to discard electrical and electronic equipment, please contact your dealer or supplier for further information.

[Information on Disposal in other Countries outside the European Union]

These symbols are only valid in the European Union. If you wish to discard these items, please contact your local authorities or dealer and ask for the correct method of disposal.



Note for the battery symbol (bottom two symbol examples):

This symbol might be used in combination with a chemical symbol. In this case it complies with the requirement set by the Directive for the chemical involved.

Cd

Contents

Information for Your Safety.....	2
----------------------------------	---

Before Use

Accessories	9
Names and Functions of Components ...	12
About the Lens	19

Preparation

Attaching/Detaching the Lens.....	21
Attaching the Shoulder Strap.....	23
Preparing the Battery.....	24
• Charging the Battery	24
• Inserting/Removing the Battery	25
• Approximate operating time and number of recordable pictures	26
Preparing the Card (Optional)	28
• Inserting/Removing the Card (Optional)	28
• About cards that can be used with this unit.....	29
• Approximate number of recordable pictures and operating time.....	30
Setting Date/Time (Clock Set)	31
• Changing the clock setting	31

Basic

Selecting the [REC] Mode	32
Taking a Still picture	34
• How to set focus when taking a still picture (AFS/AFC).....	34
• Taking Pictures with Your Favourite Settings (P : Programme AE Mode)	35
• Taking pictures using the Touch Shutter function	38
Playing Back Pictures	39
• Changing the information displayed on the playback screen	40
Recording Motion Picture	43

• How to set focus when recording a motion picture (Continuous AF)	43
• Recording Motion Picture	44
Playing Back Motion Pictures	46
Taking Pictures using the Automatic Function (IA : Intelligent Auto Mode).....	48
Deleting Pictures	52
Setting the Menu	54
• Setting menu items.....	55
Setting the Quick Menu	56
About the Setup Menu.....	58

Recording

Switching the Display of the LCD Monitor/Viewfinder.....	64
• Switching the Information Displayed on the recording screen	64
Taking Pictures with the Zoom	67
• Using the Optical Zoom/ Using the Extra Tele Conversion (EX)/Using the Digital Zoom.....	67
Taking Pictures using the Built-in Flash.....	69
• Switching to the appropriate flash setting.....	69
• Adjust the flash output.....	74
Optical Image Stabilizer.....	74
Compensating the Exposure	76
Taking Pictures using Burst Mode.....	77
Taking Pictures using Auto Bracket.....	79
Taking Pictures with the Self-timer	81
Setting the Method used to Focus (AF Mode).....	82
Taking Pictures with Manual Focus.....	85
Fixing the Focus and the Exposure (AF/AE Lock)	87
Adjusting the White Balance.....	88
Setting the Light Sensitivity	91
Taking Pictures by Specifying the Aperture/Shutter Speed.....	93
• (A) Aperture-priority AE	93
• (S) Shutter-priority AE	93
Taking Picture by Setting the Exposure Manually	94

-  [PROTECT]..... 152
-  [FACE REC EDIT] 153

Connecting to other equipment

Enjoying 3D pictures.....	154
Playing Back Pictures on a TV	
Screen	157
Saving the Recorded Still Pictures and	
Motion Pictures	162
Connecting to a PC	164
Printing the Pictures	167

Others

Optional accessories	171
LCD Monitor Display/Viewfinder	
Display	174
Cautions for Use	177
Message Display	183
Troubleshooting	186
Specifications	195

Sales and Support Information

Customer Care Centre

- For customers within the UK: 0844 844 3852
- For customers within the Republic of Ireland: 01 289 8333
- Visit our website for product information www.panasonic.co.uk
- E-mail: customer.care@panasonic.co.uk

Technical Support for AV Software

- For customers within the UK: 0844 844 3869
- For customers within the Republic of Ireland: 01 289 8333

Direct Sales at Panasonic UK

- For customers: 0844 844 3856
- Order accessory and consumable items for your product with ease and confidence by phoning our Customer Care Centre Monday – Thursday 9.00 a.m. – 5.30 p.m., Friday 9.30 a.m. – 5.30 p.m. (Excluding public holidays)
- Or go on line through our Internet Accessory ordering application at www.pas-europe.com.
- Most major credit and debit cards accepted.
- All enquiries transactions and distribution facilities are provided directly by Panasonic UK Ltd.
- It couldn't be simpler!
- Also available through our Internet is direct shopping for a wide range of finished products, take a browse on our website for further details.

Accessories

Check that all the accessories are supplied before using the camera.

Product numbers correct as of October 2010. These may be subject to change.

- 1 Digital Camera Body
(This is referred to as **camera body** in these operating instructions.)
 - 2 Interchangeable Lens
"LUMIX G VARIO HD 14–140 mm/F4.0–5.8 ASPH./MEGA O.I.S."
(This is referred to as **lens** in these operating instructions.)
 - 3 Lens Hood
 - 4 Lens Cap
(This is attached to the interchangeable lens at the time of purchase.)
 - 5 Lens Rear Cap
(This is attached to the interchangeable lens at the time of purchase.)
 - 6 Lens Storage Bag
 - 7 Interchangeable Lens
"LUMIX G VARIO 14–42 mm/F3.5–5.6 ASPH./MEGA O.I.S."
(This is referred to as **lens** in these operating instructions.)
 - 8 Lens Hood
 - 9 Lens Cap
(This is attached to the interchangeable lens at the time of purchase.)
 - 10 Lens Rear Cap
(This is attached to the interchangeable lens at the time of purchase.)
 - 11 Lens Storage Bag
 - 12 Battery Pack
(Indicated as **battery pack** or **battery** in the text)
Charge the battery before use.
 - 13 Battery Charger
(Indicated as **battery charger** or **charger** in the text)
 - 14 AC Mains Lead
 - 15 AV Cable
 - 16 USB Connection Cable
 - 17 Body Cap
(This is attached to the camera body at the time of purchase.)
 - 18 CD-ROM
 - Software:
Use it to install the software to your PC.
 - 19 Shoulder Strap
 - 20 Stylus pen
 - 21 Battery Case
- *1 Supplied in DMC-GH2H only
*2 Supplied in DMC-GH2K only
- SD Memory Card, SDHC Memory Card and SDXC Memory Card are indicated as **card** in the text.
 - **The card is optional.**
 - Description in these operating instructions is based on the 14–42 mm/F3.5–5.6 lens supplied in DMC-GH2K.
 - Consult the dealer or your nearest Service Centre if you lose the supplied accessories. (You can purchase the accessories separately.)

1



DMC-GH2H*1

2



H-VS014140

3



VYC0997

4

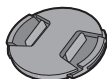

VYF3250

5



VFC4315

6



VFC4430

DMC-GH2K*2

7



H-FS014042

8



VYC1009

9

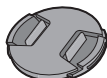

VYF3201

10



VFC4315

11



VFC4456

12



DMW-BLC12E

13

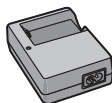

DE-A80A

14



K2CT39A00002

15

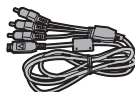

K1HA14CD0004

16

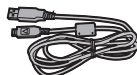

K1HA14AD0003

17



VKF4385

18



19

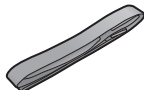

VFC4602

20



VGQ0C14

21



VGQ0Q65

■ Optional Accessories

- Battery Pack
DMW-BLC12E
- AC Adaptor*1
DMW-AC8EB
- DC Coupler*1
DMW-DCC8GU
- Zoom Lever
DMW-ZL1E
- Flash
DMW-FL220E
DMW-FL360E
DMW-FL500E
- Interchangeable Lens
H-VS014140E
H-FS014042E
H-FS014045E
H-FS045200E
H-F007014E
H-ES045E
H-H020E
H-F008E
H-H014E
H-FS100300E
H-FT012E
(Read P19 for information about other lenses that can be used.)
- MC Protector
DMW-LMCH62E*2
DMW-LMC52E*3
- ND Filter
DMW-LND62E*2
DMW-LND52E*3
- PL Filter (Circular Type)
DMW-LPL62E*2
DMW-LPL52E*3
- Leather Bag
DMW-BAL1
- Soft Bag
DMW-BAG1
- Soft Case
DMW-CG2
- Shoulder Strap
DMW-SSTL1
DMW-SSTG1
DMW-SSTG2
DMW-SSTG3
DMW-SSTG5
DMW-SSTG6
- Remote Shutter
DMW-RSL1E
- Stereo Microphone
DMW-MS1E
- HDMI mini cable
RP-CDHM15E
RP-CDHM30E

- Mount Adaptor
DMW-MA1E
DMW-MA2ME
DMW-MA3RE
- Tripod Adaptor
DMW-TA1E*4
- SDXC Memory Card
64 GB: RP-SDW64GE1K
48 GB: RP-SDW48GE1K
- SDHC Memory Card
32 GB: RP-SDW32GE1K/RP-SDP32GE1K
24 GB: RP-SDP24GE1K
16 GB: RP-SDW16GE1K/RP-SDP16GE1K
8 GB: RP-SDW08GE1K/RP-SDP08GE1K/
RP-SDR08GE1A
4 GB: RP-SDW04GE1K/RP-SDP04GE1K/
RP-SDR04GE1A
- SD Memory Card
2 GB: RP-SDP02GE1K/RP-SDR02GE1A

Some optional accessories may not be available in some countries.

*1 The AC Adaptor (optional) can only be used with the designated Panasonic DC Coupler (optional). The AC adaptor (optional) cannot be used by itself.

*2 When the 14–140 mm/F4.0–5.8 lens included in DMC-GH2H is used

*3 When the 14–42 mm/F3.5–5.6 lens included in DMC-GH2K is used

*4 Use if the attached lens is in contact with the tripod pedestal.

Names and Functions of Components

■ Camera body

- 1 Flash (P69)
 - 2 Sensor
 - 3 Self-timer indicator (P81)/
AF Assist Lamp (P132)
 - 4 Lens release button (P22)
 - 5 Lens lock pin
 - 6 Mount
 - 7 Lens fitting mark (P21)
- 8 [LVF/LCD] button (P16)
 - 9 Diopter adjustment dial (P16)
 - 10 Viewfinder (P16, 64, 174)
 - 11 Eye sensor (P16)
 - 12 Playback button (P39, 46)
 - 13 [AF/AE LOCK] button (P87)
 - 14 Camera ON/OFF switch (P31)
 - 15 Rear dial (P18)
 - 16 [DISPLAY] button (P40, 64, 96)
 - 17 Eye Cup (P178)
 - 18 Touch panel/LCD monitor (P16, 39, 64,
174)
 - 19 [Q.MENU] button (P49, 56, 84)
 - 20 Delete button (P52)/
Preview button (P96)
 - 21 [MENU/SET] button (P17, 55)
 - 22 Cursor buttons (P17)
 - ▲/ISO (P91)
 - ▶/WB (White Balance) (P88)
 - ◀/Function 2 button (P18)
 - ▼/Function 3 button (P18)

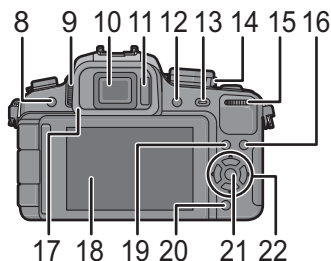
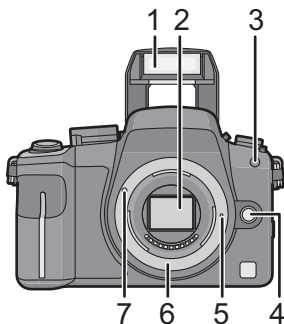

- 23 Focus mode lever (P34, 43, 82, 85)
 24 Auto focus mode dial
 Face Detection (☺) (P82): ☺
 AF Tracking (☺) (P83): ☺
 23-area-focusing (☺) (P83): ☺
 1-area-focusing (☺) (P84): ☺
- 25 Stereo microphone
- 26 Drive mode lever
 Single (P35): □
 Burst (P77): ☐
 Auto Bracket (P79): ☐
 Self-timer (P81): ☺
- 27 Shutter button (P35)
- 28 Focus distance reference mark (P86)
- 29 Flash open lever (P69)
- 30 Hot shoe (P171, 173)
- 31 Mode dial (P32)
- 32 Status indicator (P31)
- 33 Motion picture button (P44)
- 34 Function 1 button (P18)
- 35 [MIC/REMOTE] socket (P172, 173)
- 36 Shoulder strap eyelet (P23)
 • Be sure to attach the shoulder strap when using the camera to ensure that you will not drop it.
- 37 [HDMI] socket (P158)
- 38 [AV OUT/DIGITAL] socket (P157, 162, 164, 167)
- 39 Card door (P28)
- 40 DC coupler cover
 • When using an AC adaptor, ensure that the Panasonic DC coupler (DMW-DCC8; optional) and AC adaptor (DMW-AC8E; optional) are used. (P173)
- 41 Battery door (P25)
- 42 Release lever (P25)
- 43 Tripod receptacle (P182)
 • When you use a tripod, make sure the tripod is stable when the camera is attached to it.

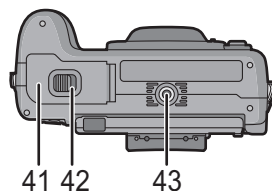
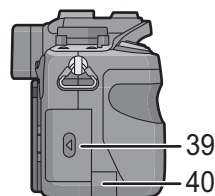
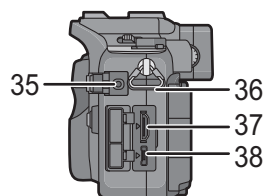
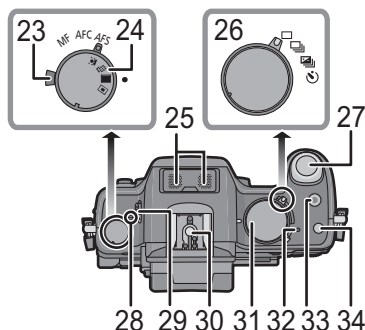

■ Lens

H-VS014140 (LUMIX G VARIO HD 14–140 mm/F4.0–5.8 ASPH./MEGA O.I.S.)

- 44 Tele
- 45 Lens surface
- 46 Focus ring (P85)
- 47 Wide
- 48 Zoom ring (P67)
- 49 [O.I.S.] switch (P74)
- 50 Contact point
- 51 Lens fitting mark (P21)

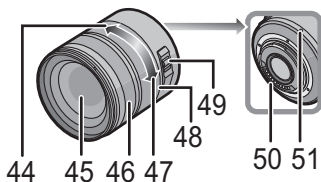

H-FS014042 (LUMIX G VARIO 14–42 mm/F3.5–5.6 ASPH./MEGA O.I.S.)

- 52 Tele
- 53 Lens surface
- 54 Focus ring (P85)
- 55 Wide
- 56 Zoom ring (P67)
- 57 Contact point
- 58 Lens fitting mark (P21)

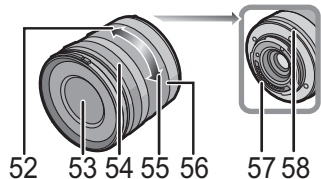

LCD Monitor

At the time when this camera is purchased, the LCD monitor is stowed in the camera body. Bring out the LCD monitor as shown below.

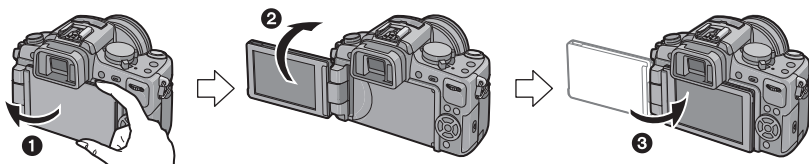

- ❶ Open the LCD monitor. (Maximum 180°)
- ❷ It can be rotated 180° forward.
- ❸ Return the monitor to its original position.

• Only rotate the LCD monitor after opening it wide enough, and be careful not to use excessive force as it may be damaged.

The LCD monitor can be rotated to suit your needs. This is convenient as it allows you to take pictures from various angles by adjusting the LCD monitor.

- Do not cover the AF Assist Lamp with your fingers or other objects.

■ Taking pictures at a high angle

- This is convenient when there is someone in front of you and you cannot get close to the subject.

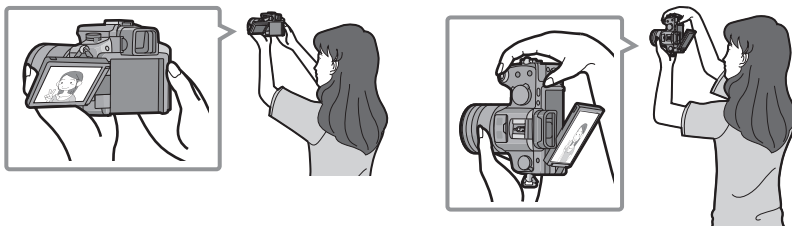

- It can only be rotated 90° towards you.

■ Taking pictures at a low angle

- This is convenient when taking pictures of flowers etc. that are in a low position.



- It can be rotated 180° forward.

Note

- When not using the LCD monitor it is recommended that you close it with the screen facing inward to prevent dirt and scratches.

Viewfinder

About the eye sensor automatic switching

Eye sensor is active when the [AUTO SWITCH] of the [LVF/LCD SWITCH] (P134) in the [CUSTOM] menu is set to [ON], switching automatically to viewfinder display when an eye or object is moved closer to the viewfinder, and to LCD monitor display when moved away. Sensitivity of the eye sensor can be set to [LOW] or [HIGH] with [SENSITIVITY].

- Eye sensor might not work properly depending on the shape of your eyeglasses, the way you hold the camera, or bright light shining around the eyepiece. Switch manually in that case.
- The eye sensor is disabled during motion picture playback and slide show.

Switching the LCD monitor/Viewfinder manually

Press [LVF/LCD] to switch the monitor screen.

- (A) [LVF/LCD] button
- (B) Eye sensor

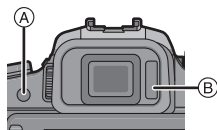

Diopter adjustment

Adjust the diopter to suit your vision so that you can see the characters displayed in the viewfinder clearly.

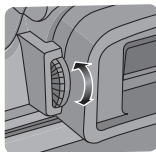

Touch Panel

This touch panel is a type that detects pressure.

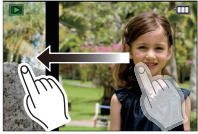
Touch the screen To touch and release the touch panel.	Drag A movement without releasing the touch panel.
 <p>Use this to perform tasks such as selecting icons or images displayed on the touch panel.</p> <ul style="list-style-type: none"> • It may not operate properly when multiple icons are touched simultaneously, so try to touch the centre of the icon. 	 <p>This is used when performing tasks such as moving to the next image by dragging horizontally, or changing the range of the displayed image.</p> <p>This can also be used to perform tasks such as switching the screen by operating the slide bar.</p>

Note

- If you use a commercially available liquid crystal protection sheet, please follow the instructions that accompany the sheet. (Some liquid crystal protection sheets may impair visibility or operability.)
- **Apply a little extra pressure** when touching if you have a commercially available protection sheet affixed or if you feel it is not responding well.
- Touch panel will not operate properly when the hand holding this unit is pressing on the touch panel.
- Do not press on the LCD monitor with hard pointed tips, such as ball point pens.
- Do not operate with your fingernails.
- Wipe the LCD monitor with dry soft cloth when it gets dirty with finger prints and others.
- Do not scratch or press the LCD monitor too hard.
- For information about the icons displayed on the touch panel, refer to "LCD Monitor Display/ Viewfinder Display" on P174.

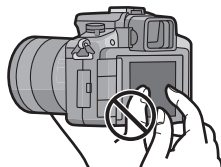

About the Stylus pen

It is easier to use the stylus pen (supplied) for detailed operation or if it is hard to operate with your fingers.

- Only use the supplied stylus pen.
- Do not place it where small children can reach.

Cursor buttons/[MENU/SET] button

This document expresses the up, down, left, and right of the cursor button as follows, or as ▲/▼/◀/▶.

e.g.: When you press the ▼ (down) button

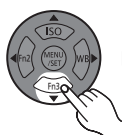

or

Press ▼

Even when the camera is operated using the touch panel, it is possible to operate with the cursor button and [MENU/SET] button if a guide like the one shown on the right is displayed.



Cursor button: Selection of items or setting of values etc. is performed.

[MENU/SET]: Confirmation of setting contents or exit from menu is performed.

Rear Dial

There are 2 ways to operate the rear dial, rotating left or right, and deciding by pressing.

Rotating:

Selection of items or setting of values is performed during the various settings.

Pressing:

Operations that are the same as [MENU/SET] button, such as selection of settings and exiting the menu, are performed during the various settings.

- Rear dial is described as follows in these operating instructions.

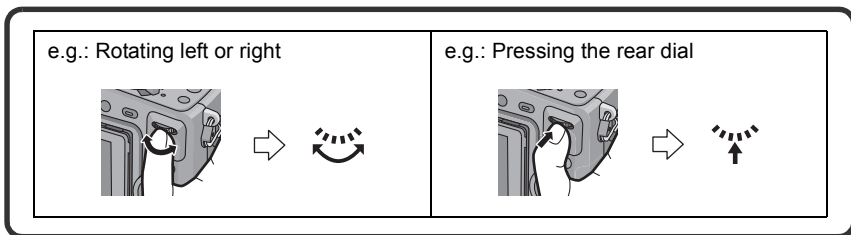

Function button

At the time of purchase, [INTELLIGENT AUTO] is assigned to the [Fn1] button, [FILM MODE] to the ◀ (Fn2) button and [METERING MODE] to the ▼ (Fn3) button.

- The functions to be assigned can be selected from the menu below using [Fn BUTTON SET] in the [CUSTOM] menu.

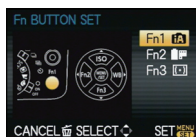

[REC] menu/Recording functions	[CUSTOM] menu
[INTELLIGENT AUTO]/[FILM MODE]/ [FOCUS AREA SET]/[ASPECT RATIO]/[QUALITY]/ [1 SHOT RAW] [RAW] [iA] / [METERING MODE] / [1 SHOT] [□] / [FLASH] / [FLASH ADJUST.] / [ISO LIMIT SET] / [EX. TELE CONV.] / [BURST RATE] / [AUTO BRACKET]	[GUIDE LINE] / [SHUTTER AF] / [PRE AF] / [% REC AREA]

Note

- Refer to P118 for details about [REC] Mode menu.
- Refer to P130 for details about [CUSTOM] menu.
- When [INTELLIGENT AUTO] is set, pushing the button will switch to Intelligent Auto Mode. (Pressing the button again or turning off the camera will cancel the setting.)
- When set to [FOCUS AREA SET], it is possible to display the position setting screen of either AF area or MF Assist.
- When [1 SHOT RAW] [RAW] [iA] is set, it will record the RAW file and a fine JPEG image simultaneously once only. It will return to original quality after recording.
- When [1 SHOT] [□] is set, it will record with [METERING MODE] set to [□] (spot) once only. It will return to original Metering Mode after recording.

About the Lens

■ Micro Four Thirds™ mount specification lens

This unit can use the dedicated lenses compatible with the Micro Four Thirds System lens mount specification (Micro Four Thirds mount).

- Select a lens that matches the scene being recorded and your use of the pictures.



■ Four Thirds™ mount specification lens

Lens with the Four Thirds mount specification can be used by using the mount adaptor (DMW-MA1; optional).



■ Leica mount specification lens

- When you use the M mount adaptor or R mount adaptor (DMW-MA2M, DMW-MA3R; optional), you can use Leica M Mount or Leica R Mount interchangeable lenses.
 - For certain lenses, the actual distance at which the subject is in focus may differ slightly from the rated distance.
 - When using a Leica lens mount adaptor, set [SHOOT W/O LENS] (P136) to [ON].

About the functions of your lens

- Depending on the type of lens, you may not be able to use some functions such as the Direction Detection Function (P36), [STABILIZER] (P74), Quick AF (P131) and Continuous AF (P131).
- The available flash range etc. differs depending on the aperture value of the lens you are using.
- Take some test pictures with the lens you are using.

- The focal length for the lens is twice that of a 35 mm film camera.
(A 50 mm lens is equivalent to a 100 mm lens.)
Focal length of the 3D interchangeable lens can be checked on the following website.

Interchangeable lenses that can be used with this unit and Auto Focus/Auto Aperture Operation (As of October 2010)

(○: Usable, ●: Some functions/features limited, —: Not usable)

Lens type		when recording still pictures		while recording motion pictures	
		Auto Focus	Auto aperture setting	Auto Focus	Auto aperture setting
Micro Four Thirds mount specification lens	HD motion picture compatible lens supplied with the DMC-GH2H (H-VS014140) (LUMIX G VARIO HD)	○ ([AFS], [AFC])	○	○*4	○
	The Lens supplied in DMC-GH2K. (H-FS014042)	○ ([AFS], [AFC])	○	●*4, 5	●*7
	The 3D interchangeable lens (H-FT012; optional)	—	—	—	—
	Other Micro Four Thirds mount specification lens*3	○ ([AFS], [AFC])	○	●*4, 5	●*7
Four Thirds mount specification lens*1	Four Thirds mount specification lens compatible to contrast AF	● ([AFS])	○	●*6	●*7
	Four Thirds mount specification lens not compatible to contrast AF	●*8 ([AFS])	○	●*6, 8	●*7
Leica mount specification lens*2	Interchangeable lens for Leica	—	—	—	—

*1 Mount adaptor (DMW-MA1; optional) is necessary to use with this unit.

*2 A Leica lens mount adaptor (DMW-MA2M or DMW-MA3R; optional) is necessary.

*3 This function is not supported by some Micro Four Thirds mount specification lenses.

For lens operations, please see our website.

*4 When recording motion pictures, the focus is continuously adjusted for both [AFS] and [AFC] (P43).

*5 AF tracking is slower than the HD motion picture compatible lens, also the sound of Auto Focus operation may be recorded.

*6 Auto Focus is activated only when the shutter button is pressed halfway. The sound of Auto Focus operation may be recorded at this time.

*7 The sound of Aperture operation may be recorded.

*8 AF performance may differ depending on the lens used. Refer to the website for details.

Refer to catalogues/Web pages for most current information regarding compatible lenses.
<http://panasonic.jp/support/global/cs/dsc/> (This Site is English only.)

Attaching/Detaching the Lens

- Check that the camera is turned off.
- Change lenses where there is not a lot of dirt or dust. Refer to P178, P179 when dirt or dust gets on the lens.

Attaching a lens to the camera body

- 1** Turn the lens rear cap **A** and the body cap **B** in the direction of the arrow to detach them.

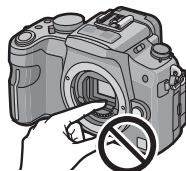
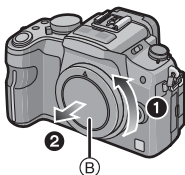
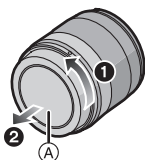

- Do not put your hands inside the mount.

- 2** Align the lens fitting marks **C** (red marks) on the camera body and the lens and then rotate the lens in the direction of the arrow until it clicks.

- Do not press the lens release button **D** when you attach a lens.
- Do not try to attach the lens when holding it at an angle to the camera body as the lens mount may get scratched.

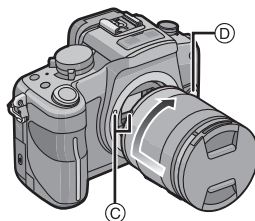

- 3** Detach the lens cap.

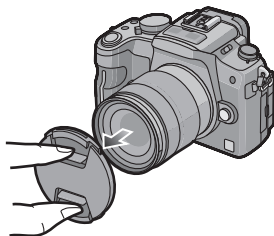

Detaching a lens from the camera body

- 1** Attach the lens cap.
- 2** Press the lens release button **D** while turning the lens as far as possible in the direction of the arrow to detach it.

- Always attach the body cap to the camera body so that dirt or dust does not get inside.
- Attach the lens rear cap so that the lens contact point does not get scratched.

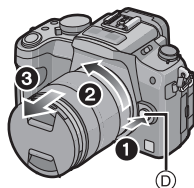

Note

- It is recommended to attach the lens cap or attach the MC Protector (optional) to protect the lens surface when carrying. (P172)

Attaching the Lens Hood

In bright sunlight or backlight, the lens hood will minimise lens flare and ghosting. The lens hood cuts off excess lighting and improves the picture quality.

To attach the lens hood (flower shape) that came with the lens supplied in DMC-GH2H/DMC-GH2K

Insert the lens hood into the lens with the short sides at the top and bottom, and turn in the direction of the arrow until it stops.

- (A) Fitting to the mark.

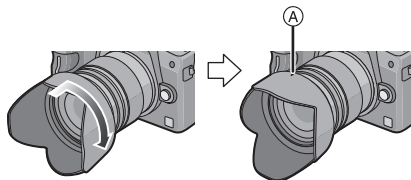

Note

- When temporarily detaching and carrying the lens hood supplied with the DMC-GH2H/DMC-GH2K, attach the lens hood to the lens in the reverse direction.

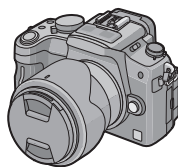

Attaching the Shoulder Strap

- We recommend attaching the shoulder strap when using the camera to prevent it from dropping.

- 1** Pass the shoulder strap through the shoulder strap eyelet on the camera body.

(A): Shoulder strap eyelet

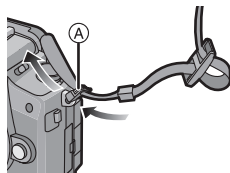

- 2** Pass the end of the shoulder strap through the ring in the direction of the arrow and then pass it through the stopper.

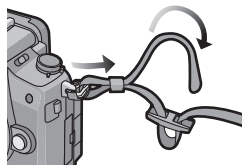

- 3** Pass the end of the shoulder strap through the hole on the other side of the stopper.

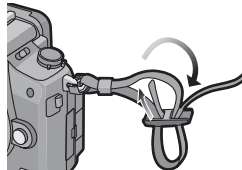

- 4** Pull the other side of the shoulder strap and then check that it will not come out.

- Perform steps **1** to **4** and then attach the other side of the shoulder strap.

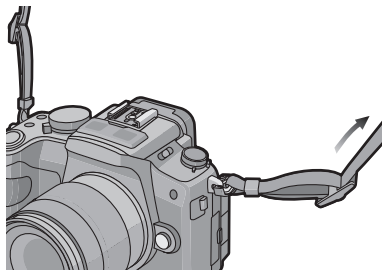

Note

- Use the shoulder strap around your shoulder.
 - Do not wrap the strap around your neck.
 - It may result in injury or accident.
- Do not leave the shoulder strap where an infant can reach it.
 - It may result in an accident by mistakenly wrapping around the neck.

Preparing the Battery

■ About batteries that you can use with this unit

The battery that can be used with this unit is DMW-BLC12E.

It has been found that counterfeit battery packs which look very similar to the genuine product are made available to purchase in some markets. Some of these battery packs are not adequately protected with internal protection to meet the requirements of appropriate safety standards. There is a possibility that these battery packs may lead to fire or explosion. Please be advised that we are not liable for any accident or failure occurring as a result of use of a counterfeit battery pack. To ensure that safe products are used we would recommend that a genuine Panasonic battery pack is used.

- Use the dedicated charger and battery.
- The camera has a function for distinguishing batteries which can be used safely. The dedicated battery (DMW-BLC12E) supports this function. The only batteries suitable for use with this unit are genuine Panasonic products and batteries manufactured by other companies and certified by Panasonic. (Batteries which do not support this function cannot be used.) Panasonic cannot in any way guarantee the quality, performance or safety of batteries which have been manufactured by other companies and are not genuine Panasonic products.

Charging the Battery

- The battery is not charged when the camera is shipped. Charge the battery before use.
- Charge the battery with the charger indoors.

- 1 Attach the battery paying attention to the direction of the battery.**

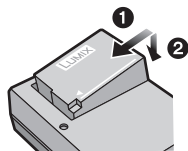

- 2 Connect the AC mains lead.**

- Disconnect the charger from the electrical socket and detach the battery after charging is completed.

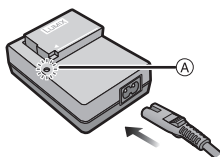

■ About the [CHARGE] indicator

The [CHARGE] indicator turns on: The [CHARGE] indicator (A) is turned on and charging will start.

The [CHARGE] indicator turns off: The [CHARGE] indicator (A) of the charger will turn off once the charging has completed without any problem.

• When the [CHARGE] indicator flashes

- The battery temperature is too high or too low. It is recommended to charge the battery again in an ambient temperature of between 10 °C to 30 °C (50 °F to 86 °F).
- The terminals of the charger or the battery are dirty. In this case, wipe them with a dry cloth.

■ Charging time

Charging time	Approx. 140 min
<ul style="list-style-type: none"> • The indicated charging time is for when the battery has been discharged completely. The charging time may vary depending on how the battery has been used. The charging time for the battery in hot/cold environments or a battery that has not been used for a long time may be longer than normal. 	

Note

- Do not leave any metal items (such as clips) near the contact areas of the power plug. Otherwise, a fire and/or electric shocks may be caused by short-circuiting or the resulting heat generated.
- The battery can be recharged even when it still has some charge left, but it is not recommended that the battery charge be frequently topped up while the battery is fully charged. (Since characteristic swelling may occur.)

Inserting/Removing the Battery

- Check that this unit is turned off.

1 Slide the release lever in the direction of the arrow and open the battery door.

- Always use genuine Panasonic batteries (DMW-BLC12E).
- If you use other batteries, we cannot guarantee the quality of this product.

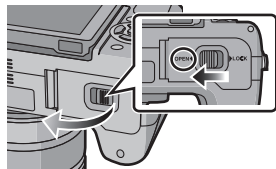

2 Being careful about the battery orientation, insert all the way until you hear a locking sound and then check that it is locked by lever (A). Pull the lever (A) in the direction of the arrow to remove the battery.

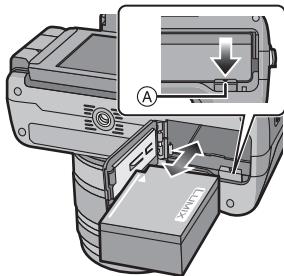

3 Close the battery door, and slide the release lever.

 **Note**

- **Remove the battery after use. Store the removed battery in the battery case (supplied).**
- The battery will be exhausted if left for a long period of time after being charged.
- Before removing the battery, turn the camera off, and wait until the status indicator has gone off completely. (Otherwise, this unit may no longer operate normally and the card itself may be damaged or the recorded pictures may be lost.)
- The supplied battery is designed only for the camera. Do not use it with any other equipment.
- The battery becomes warm after using it and during and after charging. The camera also becomes warm during use. This is not a malfunction.

Approximate operating time and number of recordable pictures

■ Battery indication

The battery indication is displayed on the screen.

[It does not appear when you use the camera with the AC adaptor (DMW-AC8E; optional) connected.]



- The indication turns red and blinks if the remaining battery power is exhausted. (The status indicator also blinks) Recharge the battery or replace it with a fully charged battery.

■ Recording still pictures (when using the LCD monitor)

(By CIPA standard in Programme AE Mode)

	When the 14–140 mm/F4.0–5.8 lens supplied in DMC-GH2H is used
Number of recordable pictures	Approx. 320 pictures
Recording time	Approx. 160 min

	When the 14–42 mm/F3.5–5.6 lens supplied in DMC-GH2K is used
Number of recordable pictures	Approx. 330 pictures
Recording time	Approx. 165 min

■ Recording still pictures (when using the viewfinder)

(By CIPA standard in Programme AE Mode)

	When the 14–140 mm/F4.0–5.8 lens supplied in DMC-GH2H is used
Number of recordable pictures	Approx. 330 pictures
Recording time	Approx. 165 min

	When the 14–42 mm/F3.5–5.6 lens supplied in DMC-GH2K is used
Number of recordable pictures	Approx. 340 pictures
Recording time	Approx. 170 min

Recording conditions by CIPA standard

- CIPA is an abbreviation of [Camera & Imaging Products Association].
- Temperature: 23 °C (73.4 °F)/Humidity: 50%RH when LCD monitor is on.
- Using a Panasonic SD Memory Card (2 GB).
- Using the supplied battery.
- Starting recording 30 seconds after the camera is turned on.
- **Recording once every 30 seconds** with full flash every second recording.
- Turning the camera off every 10 recordings and leaving it until the temperature of the battery decreases.

The number of recordable pictures varies depending on the recording interval time. If the recording interval time becomes longer, the number of recordable pictures decreases. [For example, if you were to take one picture every two minutes, then the number of pictures would be reduced to approximately one-quarter of the number of pictures given above (based upon one picture taken every 30 seconds).]

■ Playback (when using the LCD monitor)

	When the 14–140 mm/F4.0–5.8 lens supplied in DMC-GH2H is used
Playback time	Approx. 240 min
	When the 14–42 mm/F3.5–5.6 lens supplied in DMC-GH2K is used
Playback time	Approx. 250 min

Note

- **The operating times and number of recordable pictures will differ according to the environment and the operating conditions.**

For example, in the following cases, the operating times shorten and the number of recordable pictures is reduced.

- In low-temperature environments, such as on ski slopes.
- Using the [AUTO] of [LCD MODE] or [MODE1] of [LCD MODE] (P59).
- When flash is used repeatedly.
- When the operating time of the camera becomes extremely short even after properly charging the battery, the life of the battery may have expired. Buy a new battery.

Preparing the Card (Optional)

Inserting/Removing the Card (Optional)

- Check that this unit is turned off.
- We recommend using a Panasonic card.

1 Slide the card door to open it.

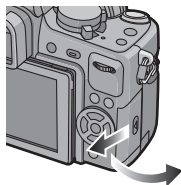

2 Push it securely all the way until you hear a “click” while being careful about the direction in which you insert it. To remove the card, push the card until it clicks, then pull the card out upright.

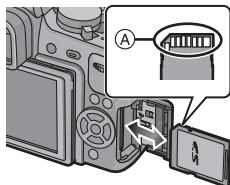

(A): Do not touch the connection terminals of the card.

- The card may be damaged if it is not fully inserted.

3 **1**: Close the card door.

2: Slide the card door to the end and then close it firmly.

- If the card door cannot be completely closed, remove the card, check its direction and then insert it again.

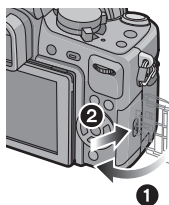

Note

- Always turn the camera off before opening the card door.
- Before removing the card, turn the camera off, and wait until the status indicator has gone off completely. (Otherwise, this unit may no longer operate normally and the card itself may be damaged or the recorded pictures may be lost.)

About cards that can be used with this unit

The following cards which conform to the SD video standard can be used with this unit. (These cards are indicated as **card** in the text.)

Type of card which can be used with this unit	Remarks
SD Memory Card (8 MB to 2 GB)	<ul style="list-style-type: none"> SDHC Memory Card can be used with SDHC Memory Card or SDXC Memory Card compatible equipment. SDXC Memory Card can only be used with SDXC Memory Card compatible equipment. Check that the PC and other equipment are compatible when using the SDXC Memory Cards. http://panasonic.net/avc/sdcard/information/SDXC.html
SDHC Memory Card (4 GB to 32 GB)	
SDXC Memory Card (48 GB, 64 GB)	

- Only cards bearing the SDHC logo (indicating that the card conforms to SD video standards) may be used as 4 GB to 32 GB cards.
 - Only cards bearing the SDXC logo (indicating that the card conforms to SD video standards) may be used as 48 GB and 64 GB cards.
 - Use a card with SD Speed Class* with "Class 4" or higher when recording motion pictures in [AVCHD]. Also, use a card with SD Speed Class with "Class 6" or higher when recording motion pictures in [MOTION JPEG].
- * SD Speed Class is the speed standard regarding continuous writing. Check via the label on the card, etc.

e.g.:



- Please confirm the latest information on the following website.

<http://panasonic.jp/support/global/cs/dsc/>

(This Site is English only.)

Access to the card

The access indication lights red when pictures are being recorded on the card.



- Do not turn this unit off, remove its battery or card, or disconnect the AC adaptor (DMW-AC8E; optional) when the access indication is lit [when pictures are being written, read or deleted, or the card is being formatted (P63)]. Furthermore, do not subject the camera to vibration, impact or static electricity.**
The card or the data on the card may be damaged, and this unit may no longer operate normally.
If operation fails due to vibration, impact or static electricity, perform the operation again.

Note

- Write-Protect switch (A) provided (When this switch is set to the [LOCK] position, no further data writing, deletion or formatting is possible. The ability to write, delete and format data is restored when the switch is returned to its original position.)
- The data on the card may be damaged or lost due to electromagnetic waves, static electricity or breakdown of the camera or the card. We recommend storing important data on a PC etc.
- Do not format the card on your PC or other equipment. Format it on the camera only to ensure proper operation. (P63)
- Keep the Memory Card out of reach of children to prevent swallowing.



Approximate number of recordable pictures and operating time

■ About the display of the number of recordable pictures and operating time

- Switching between the display of number of recordable pictures and operating time can be performed in the [REMAINING DISP.] (P134) in the [CUSTOM] menu.

- (A) Number of recordable pictures
- (B) Available recording time



■ Number of recordable pictures

- [9999+] is displayed if there are more than 10000 pictures remaining. Number of recordable pictures for more than 10000 can be checked in the LCD recording information display (P64).

• Aspect ratio [4:3], Quality [FINE]

Picture size	2 GB	4 GB	16 GB	64 GB
L (16M)	220	440	1830	7260
M (8M)	410	810	3330	13000
S (4M)	680	1350	5550	21490

• Aspect ratio [4:3], Quality [RAW+]

Picture size	2 GB	4 GB	16 GB	64 GB
L (16M)	70	135	560	2240
M (8M)	81	160	660	2600
S (4M)	88	170	710	2820

■ Available recording time (when recording motion pictures)

• [AVCHD]

Recording quality setting	2 GB	4 GB	16 GB	64 GB
24H	10 min 00 s	21 min 00 s	1 h 32 min	6 h 13 min
24L	13 min 00 s	28 min 00 s	2 h 4 min	8 h 25 min
FSH	13 min 00 s	28 min 00 s	2 h 4 min	8 h 25 min
FH	17 min 00 s	37 min 00 s	2 h 43 min	11 h 1 min
SH	13 min 00 s	28 min 00 s	2 h 4 min	8 h 25 min
H	17 min 00 s	37 min 00 s	2 h 43 min	11 h 1 min

• [MOTION JPEG]

Recording quality setting	2 GB	4 GB	16 GB	64 GB
HD	7 min 20 s	15 min 20 s	1 h 6 min	4 h 29 min
WVGA	18 min 30 s	38 min 40 s	2 h 46 min	11 h 12 min
VGA	19 min 10 s	40 min 10 s	2 h 52 min	11 h 39 min
QVGA	53 min 20 s	1 h 51 min	7 h 58 min	32 h 16 min

- The number of recordable pictures and operating time will increase or decrease in proportion to the capacity of the card. (These vary depending on the recording conditions and the type of card.)
- Motion pictures can be recorded continuously for up to 29 minutes 59 seconds. Also, motion picture recorded continuously in [MOTION JPEG] is up to 2 GB. (Example: [7m 20s] with [HD+]) Remaining time for continuous recording is displayed on the screen.

Setting Date/Time (Clock Set)

• The clock is not set when the camera is shipped.

1 Turn the camera on.

- The status indicator **1** lights when you turn this unit on.

Ⓐ [MENU/SET] button

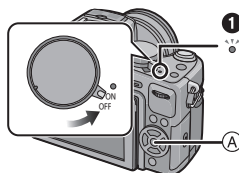

2 Press [MENU/SET].



MENU/SET

3 Press ◀/▶ to select the items (year, month, day, hour, minute, display sequence or time display format), and press ▲/▼ to set.

Ⓐ: Time at the home area

Ⓑ: Time at the travel destination (P116)

⏏: Cancel without setting the clock.

Ⓐ:
 Ⓑ:

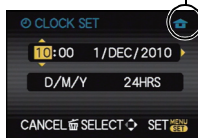

4 Press [MENU/SET] to set.

5 Press [MENU/SET].

- After completing the clock settings, turn the camera off. Then turn the camera back on, and check that the display reflects the settings that were performed.
- When [MENU/SET] has been pressed to complete the settings without the clock having been set, set the clock correctly by following the “Changing the clock setting” procedure.

Changing the clock setting

Select [CLOCK SET] in the [SETUP] menu, and press ▶. (P55)

- It can be changed in steps 3, 4 and 5 to set the clock.
- **The clock setting is maintained for 3 months using the built-in clock battery even without the battery. (Leave the charged battery in the unit for 24 hours to charge the built-in battery.)**

Note

- The clock is displayed when [DISPLAY] is pressed several times during recording.
- You can set the year from 2000 to 2099.
- If the clock is not set, the correct date cannot be printed when you stamp the date on the pictures with [TEXT STAMP] (P145) or order a photo studio to print the pictures.
- If the clock is set, the correct date can be printed even if the date is not displayed on the screen of the camera.

Mode switching

Selecting the [REC] Mode

- (A) Mode dial
- (B) [Fn1] button

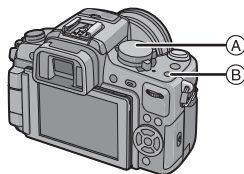

Switching the mode by rotating the mode dial.

Align a desired mode with part (C).

- Rotate the mode dial slowly and surely to adjust to each mode.
- [INTELLIGENT AUTO] is initially assigned to the [Fn1] button. It will switch to Intelligent Auto Mode when the [Fn1] button is pressed, disabling the Recording Mode selected by the mode dial. It is possible to change the function assigned to the buttons with [Fn BUTTON SET] in [CUSTOM] menu. (P18)

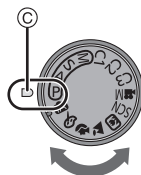

■ Basic

P Programme AE Mode (P35)

The subjects are recorded using your own settings.

iA Intelligent Auto Mode (P48)

The subjects are recorded using settings automatically selected by the camera.

■ Advanced

Aperture-Priority AE Mode (P93)

The shutter speed is automatically determined by the aperture value you set.

Shutter-Priority AE Mode (P93)

The aperture value is automatically determined by the shutter speed you set.

Manual Exposure Mode (P94)

The exposure is adjusted by the aperture value and the shutter speed which are manually adjusted.

Custom Mode (P105)

Use this mode to take pictures with previously registered settings.

Creative Motion Picture Mode (P106)

Use this mode to record motion pictures in the selected mode.

* You cannot take still pictures.

Scene Mode (P99)

This allows you to take pictures that match the scene being recorded.

My Colour Mode (P103)

Use this mode to check colouring effects, select a colour mode from among eight colour modes, and then take pictures.

■ Advanced Scene Mode

Portrait Mode (P97)

Use this mode to take pictures of people.

Scenery Mode (P98)

Use this mode to take pictures of scenery.

Close-up Mode (P98)

Use this mode to take pictures of a close-by subject.

Taking a Still picture

How to set focus when taking a still picture (AFS/AF-C)

1 Select the focus mode.

- Normally use the [AFS].

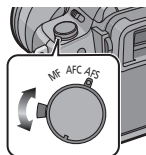

AFS	<p>"AFS" is an abbreviation of "Auto Focus Single". Focus is set automatically when the shutter button is pressed halfway. Focus will be fixed while it is pressed halfway.</p>
AF-C	<p>"AF-C" is an abbreviation of "Auto Focus Continuous". This mode allows you to compose a picture more easily by continuously focusing on the movement of the subject while the shutter button is pressed halfway.</p> <p>When taking pictures of a moving subject, the camera predicts the movement of the subject and focuses on it. (motion prediction)</p> <ul style="list-style-type: none"> • It may take time to focus on the subject if you rotate the zoom ring from Wide to Tele or suddenly change the subject from a distant one to a nearby one. • Press the shutter button halfway again when it is difficult to focus on the subject. • When the brightness is not enough, this will work the same as [AFS]. • [AF-C] will not operate with certain lenses. For details, refer to page 20.
MF	Set the focus manually by rotating the focus ring. (P85)

2 Press the shutter button halfway.

(Focusing action for [AFS])

Focus	When the subject is focused	When the subject is not focused
Focus indication	On	Blinks
AF area	Green	—
Sound	Beeps 2 times	—

- (A) Focus indication
- (B) AF area



Note

- Focus sound will not beep if the Focus Mode is set to [AF-C]. Also, the AF area will not be displayed if the AF Mode is set to [AF-C].
- The focus range is different depending on the lens used.
 - When the 14–140 mm/F4.0–5.8 lens supplied in DMC-GH2H is used: 0.5 m (1.64 feet) to ∞
 - When the 14–42 mm/F3.5–5.6 lens supplied in DMC-GH2K is used: 0.3 m (0.99 feet) to ∞

■ Subjects and recording conditions which are difficult to focus

- Fast-moving subjects, extremely bright subjects or subjects without contrast
- When recording subjects through windows or near shiny objects
- When it is dark or when jitter occurs
- When the camera is too close to the subject or when taking a picture of both distant and near subjects

Taking Pictures with Your Favourite Settings (P: Programme AE Mode)

The camera automatically sets the shutter speed and the aperture value according to the brightness of the subject.

You can take pictures with greater freedom by changing various settings in [REC] Mode menu.

- Set the drive mode lever to [□] (single).

1 Set the mode dial to [P].

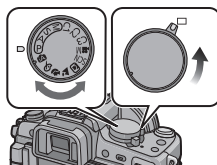

2 Press the shutter button halfway to focus.

- (A) Aperture value
- (B) Shutter speed

- Aperture value and shutter speed are displayed. (It will flash in red if the correct exposure is not achieved, except when set to flash.)
- **You will not be able to take a picture until the focus is set, since the [FOCUS PRIORITY] (P131) is set initially to [ON].**



3 Press the shutter button fully (push it in further), and take the picture.

- The access indication lights (P29) red when pictures are being recorded on the card.



Note

- To change the setting while taking pictures, refer to “Using the [REC] Mode Menu” (P118) or “Using the [CUSTOM] Menu” (P130).
- The shutter speed is automatically set between about 15 seconds and 1/4000th of a second in the following cases.
 - When the [SENSITIVITY] is set to [ISO160].
 - When the aperture value is set to F4.0 (when the 14–140 mm/F4.0–5.8 lens supplied in DMC-GH2H is attached).
 - When the aperture value is set to F3.5 (when the 14–42 mm/F3.5–5.6 lens supplied in DMC-GH2K is attached).

Tips for taking good pictures

Ⓐ AF assist lamp

- **Do not cover the flash or the AF assist lamp with your fingers or other objects.**
- Hold the camera gently with both hands, keep your arms still at your side and stand with your feet slightly apart.
- Be careful not to move the camera when you press the shutter button.
- When taking pictures, make sure your footing is stable and there is no danger of colliding with another person, an object etc.
- You cannot record 3D pictures in vertical orientation.



■ Direction Detection Function

Pictures recorded with the camera held vertically are played back vertically (rotated). (Only when [ROTATE DISP.] (P149) is set to [ON])

- The Direction Detection Function may not operate correctly if recording is performed with the camera aimed up or down.
- You can only use the Direction Detection Function when using a compatible lens. (Refer to the catalogue, website etc. for compatible lenses.)

Programme Shift

In Programme AE Mode, you can change the preset aperture value and shutter speed without changing the exposure. This is called Programme Shift.

You can make the background more blurred by decreasing the aperture value or record a moving subject more dynamically by slowing the shutter speed when taking a picture in Programme AE Mode.



- 1 Press the shutter button halfway and display the aperture value and shutter speed value on the screen.**
 - 2 While the values are displayed (about 10 seconds), perform the Programme Shift by rotating the rear dial.**
- It will switch between Programme Shift operation and Exposure Compensation operation (P76) every time the rear dial is pressed while the values are displayed.
 - Rotate the rear dial to display the [EXPO.METER] (B). (P133)
 - The Programme Shift indication (A) appears on the screen when Programme Shift is activated.
 - To cancel Programme Shift, turn the camera off or rotate the rear dial until the Programme Shift indication disappears.

■ Example of Programme Shift

(When the 14–42 mm/F3.5–5.6 lens supplied in DMC-GH2K is used)

(A): Aperture value

(B): Shutter speed

- 1** Programme Shift amount
- 2** Programme Shift line chart
- 3** Programme Shift limit

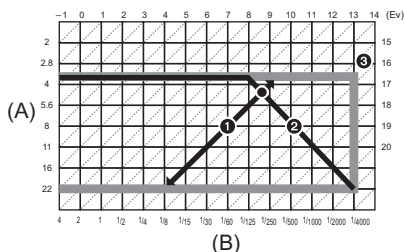

Note

- EV is an abbreviation of [Exposure Value].
- How the Exposure Compensation is switched can be changed by [EXPO. SETTINGS] (P133) in the [CUSTOM] menu.
- If the exposure is not adequate when the shutter button is pressed halfway, the aperture value and shutter speed turn red and blink.
- Programme Shift is cancelled and the camera returns to normal Programme AE Mode if more than 10 seconds pass after Programme Shift is activated. However, the Programme Shift setting is memorised.
- Depending on the brightness of the subject, Programme Shift may not be activated.
- Programme Shift is not possible when the [SENSITIVITY] is set to [ISO].

Taking pictures using the Touch Shutter function

Applicable modes: **P A S M C1 C2 C3**

Just by touching the subject to focus, it will focus on the subject and take the picture automatically.

1 Touch [] in Recording Mode.

- Icon will change to [], and taking a picture with the Touch Shutter function becomes possible.



2 Touch the subject you wish to focus on, and then take a picture.

- (A) Rough indication of the area that can be focused with the Touch Shutter
- AF area with same function as [] in AF Mode is displayed at the position you touch, and a picture is taken when it is focused. (It cannot be set to edge of the screen.)
- If the histogram is displayed on top of the subject you want to touch, touch the subject after first moving the histogram. (P66)

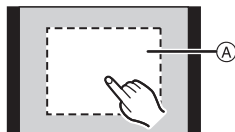

3 Touch [] to cancel the Touch Shutter function.

Note

- If [FOCUS PRIORITY] is [ON], when the Focus Mode is set to [AFS] and the Touch Shutter fails, AF area will disappear after turning red, and the picture will not be taken. When set to [AFC], the picture will not be taken if the focus indication is flashing green, but if the subject comes into focus while keeping touching the screen, the picture will be taken.
- Measurement of brightness is performed on the spot touched when the [METERING MODE] is set to []. (P122)

Playing Back Pictures

1 Press [▶].

A [▶] button

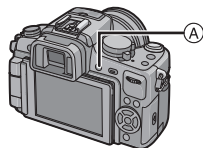

2 Forward or rewind the image by dragging (P16) the screen horizontally.

Forward: drag from right to left

Rewind: drag from left to right

- It is also possible to forward or rewind the image by pressing ◀/▶ of the cursor button.
- Speed of picture forwarding/rewinding changes depending on the playback status.
- You can forward or rewind pictures continuously by keeping your finger on the left or right sides of the screen after forwarding/rewinding a picture.
(Pictures are displayed reduced in size)

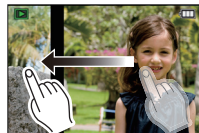

■ To finish playback

Press [▶] again, press the motion picture button or press the shutter button halfway.

Note

- This camera complies with the DCF standard "Design rule for Camera File system" established by JEITA "Japan Electronics and Information Technology Industries Association" and with Exif "Exchangeable Image File Format". Files which do not comply with the DCF standard cannot be played back.

Changing the information displayed on the playback screen

Press **[DISPLAY]** to switch the monitor screen.

(A) **[DISPLAY]** button

- During Playback Zoom (P42), while playing back motion pictures (P46) and during a slide show (P141), you can only select "Normal display **(B)**" or "No display **(F)**".
- Histogram **(D)** is displayed in R (red), G (green), B (blue), and Y (luminance) during the playback.

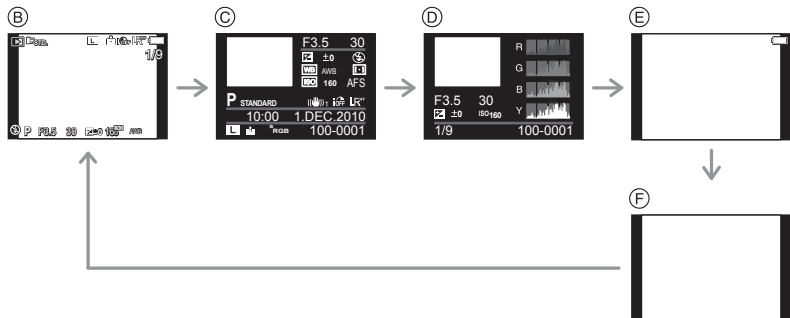

(B) Normal display

(C) Detailed information display

(D) Histogram display

(E) Highlight display*

(F) No display

* This is displayed if **[HIGHLIGHT]** (P130) in the **[CUSTOM]** menu is set to **[ON]**.

Displaying multiple screens (Multi Playback)

Rotate the rear dial left.

1 screen → 12 screens → 30 screens → Calendar screen display

(A) Number of the selected picture and the total number of recorded pictures

(B) Slide bar

(C) Burst icon



• Rotate the rear dial right to return to the previous screen.

• If you select a picture with the Burst icon , and press **[MENU/SET]**, the pictures from within that Burst Picture group will be played back using Multi Playback.

• Screen can be switched by dragging the slide bar up or down (P16).

• The screen can be switched gradually by dragging the screen up or down (P16).

• Pictures are not rotated for display.

• Pictures displayed using cannot be played back.

■ To return to Normal Playback

Touch the picture to select.

• You can also return to the one screen display by choosing images pressing the cursor button, and then pressing **[MENU/SET]** or the rear dial.

Displaying Pictures by Recording Date (Calendar Playback)

- 1** Rotate the rear dial left to display the Calendar screen.



- 2** Press ▲/▼/◀/▶ to select the date to be played back.

- If there were no pictures recorded during a month, the month is not displayed.

- 3** Press [MENU/SET] or the rear dial to display the pictures that were recorded on the selected date.

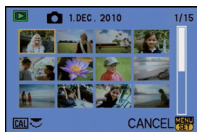

OR



- Rotate the rear dial left to return to the Calendar screen display.
- If you select a picture with the Burst icon [📷], and press [MENU/SET], the pictures from within that Burst Picture group will be played back using Multi Playback.

- 4** Press ▲/▼/◀/▶ to select a picture and then press [MENU/SET] or the rear dial.

- The picture that was selected will appear.

Note

- The recording date of the picture selected in the playback screen becomes the date selected when the Calendar screen is first displayed.
- If there are multiple pictures with the same recording date, the first picture recorded on that day is displayed.
- You can display the Calendar between January 2000 and December 2009.
- If the date is not set in the camera, the recording date is set as the 1st January, 2010.
- If you take pictures after setting the travel destination in [WORLD TIME], the pictures are displayed by the dates at the travel destination in Calendar Playback.



Using the Playback Zoom

1 Touch the part to enlarge.

1× → 2× → 4× → 8× → 16×

- Picture can be enlarged also by rotating the rear dial right.
- When you change the magnification, the zoom position indication (A) appears for about 1 second.
- The more a picture is enlarged, the more its quality deteriorates.

**2 Move the position to be displayed by dragging the picture (P16).**

- When you move the position to be displayed, the zoom position indication (A) appears for about 1 second.
- Position of the enlarged part can be also moved by pressing the cursor button.
- Picture will return to the original size (1×) by touching [].
- Also, when you touch [] or rotate the rear dial left, the magnification becomes lower.

**Switching the displayed image while maintaining the Playback Zoom**

You can switch the displayed image while maintaining the same zoom magnification and zoom position for the Playback Zoom.

Switch to picture select operation by pressing the rear dial during Playback Zoom, and select pictures with ◀/▶.

- It will switch between picture select operation and move zoom position operation every time the rear dial is pressed during Playback Zoom.

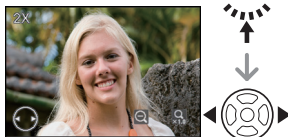
**Note**

- You can also delete the recording information etc. on the screen during Playback Zoom by pressing [DISPLAY].
- If you want to save the enlarged picture, use the Cropping function. (P148)
- The Playback Zoom may not operate if pictures have been recorded with other equipment.
- The zoom magnification and the zoom position are cancelled when the camera is turned off (including Sleep Mode).
- The zoom position returns to the centre in the following images.
 - Images with different aspect ratios
 - Images with different numbers of recorded pixels
 - Images with a different rotation direction (when [ROTATE DISP.] is set to [ON])
- Playback Zoom is not available during Motion Picture Playback.

[REC] Mode: 

Recording Motion Picture

This can record full high definition motion pictures compatible with the AVCHD format or motion pictures recorded in Motion JPEG.

Audio will be recorded in stereo.

The functions available when recording motion pictures differ according to the lens you are using, and the operational sound of the lens may be recorded.

Refer to page 20 for details.

How to set focus when recording a motion picture (Continuous AF)

Focusing changes depending on the Focus Mode setting and the [CONTINUOUS AF] setting in the [MOTION PICTURE] Mode menu.

Focus Mode	[CONTINUOUS AF]	Settings
AFS/AFC	ON	You can have the camera focus continuously. • Press the shutter button halfway when it is difficult to focus on the subject.
	OFF	The focus position is fixed when beginning to record a motion picture. • It is possible to set the focus by pressing the shutter button halfway or touching the subject.
MF	ON	You can focus manually.
	OFF	

- Depending on the recording conditions or lens used, operational sound may be recorded when the Auto Focus is operated while recording a motion picture. It is recommended to record with [CONTINUOUS AF] in the [MOTION PICTURE] Mode menu set to [OFF], if the sound of operation bothers you to avoid recording the lens noise.
- When operating the zoom when recording motion pictures, it may take time to come into focus.

Recording Motion Picture

Recording of motion picture appropriate for each mode is possible.

- **Screen here is an example of when the mode dial is set to [P] (Programme AE Mode).**

- (A) Mode dial
- (B) Motion picture button

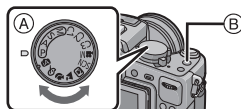

1 Start recording by pressing the motion picture button.

- (C) Elapsed recording time
- (D) Available recording time

- Sound will be heard when pressing the motion picture button indicating start/stop of motion picture recording.
- The recording state indicator (red) (E) will flash while recording motion pictures.

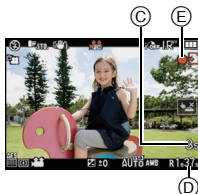

2 Stop the recording by pressing the motion picture button again.

Note

- **The flash setting is fixed to [☺].**
- Audio will not be recorded for 0.5 seconds after it starts recording if the motion picture button is kept pressed. Release the motion picture button right after you press it.
- The operational sound of the zoom or button operation may be recorded when it is operated during the recording of a motion picture.
- The available recording time displayed on the screen may not decrease regularly.
- Depending on the type of the card, the card access indication may appear for a while after recording motion pictures. This is not a malfunction.
- When the aspect ratio setting is different in still and motion pictures, the angle of view changes at the start of motion picture recording. When [9 REC AREA] (P134) is set to [1], angle of view during motion picture recording is displayed.
- When the [EX. TELE CONV.] is set to [ON], the angle of view will change when the screen is switched between the still picture screen and motion picture screen, because the zoom factor is different between still pictures and motion pictures. (P67)
- The ISO sensitivity will be set to [AUTO] (for motion pictures) when recording motion pictures.
- When recording a motion picture, [STABILIZER] will be fixed to [MODE1] even if it is set to [MODE2] or [MODE3].
- When recording motion pictures, the following functions cannot be used.
 - [AF-ON] in the AF Mode (It will switch to [AF-ON].)
 - [AF-ON] in the AF Mode (It will switch to Multi Auto Focus Mode for motion pictures.)
 - Direction Detection Function
 - [FACE RECOG.]/[ISO LIMIT SET]
- It is recommended to use a fully charged battery or AC adaptor (DMW-AC8E; optional) when recording motion pictures. (P173)
- If while recording motion pictures using the AC adaptor (DMW-AC8E; optional) the power supply is cut off due to a power cut or if the AC adaptor (DMW-AC8E; optional) is disconnected etc., the motion picture being recorded will not be recorded.

- Motion pictures recorded in [AVCHD] or [MOTION JPEG] may be played back with poor picture or sound quality or playback may not be possible even when played back with equipment compatible with these formats. Also, the recording information may not be displayed properly. In this case, use this unit.

For details on AVCHD compatible devices, refer to the support site below.

<http://panasonic.jp/support/global/cs/dsc/>

(This Site is English only.)

- The sound recording specifications on this model have been changed to improve audio quality. For this reason, some motion pictures recorded in [MOTION JPEG] and pictures with audio may not be played back with Panasonic digital cameras (LUMIX)*.

(Motion pictures recorded with a Panasonic digital camera (LUMIX) can be played back on this model.)

- * Models launched before December 2008, and some models launched in 2009 (FS, LS series).
- To play back AVCHD motion pictures recorded with this unit on Panasonic Blu-ray Disc Players (DMP-BD30/DMP-BD31/DMP-BD50) it is necessary to update the firmware of the Blu-ray Disc Player.

You can download the latest firmware version from the following website.

<http://panasonic.net/support/>

Playing Back Motion Pictures

- This unit was designed to play motion pictures using the AVCHD and QuickTime Motion JPEG formats that were taken with this model (only).
- Motion pictures in AVCHD format that can be played back on this unit are [AVCHD] motion pictures that were recorded with this unit, AVCHD format (including [AVCHD Lite]) motion pictures recorded with Panasonic digital cameras (LUMIX) only.

1 Press [▶].

2 Select a picture with a Motion Picture icon ([👤]), [📷]) and then touch [▶] to play back.

- (A) Motion picture icon
- (B) The motion picture recording time

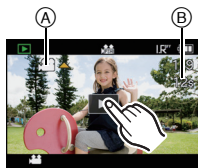

- After playback starts, the elapsed playback time is displayed on the upper right of the screen.
For example, 8 minutes and 30 seconds is displayed as [8m30s].
- Some information (recording information, etc.) is not displayed for motion pictures recorded in [AVCHD].
- Pressing the cursor button ▲ to allows you to playback motion pictures.
Display at the bottom right of the screen while playing back corresponds to ▲/▼/◀/▶ on the cursor button.

Operations performed during Motion Picture Playback

1 Display control panel by touching screen.

- If no operation is performed for 2 seconds, it will return to original status.

2 Operate control panel by touching.

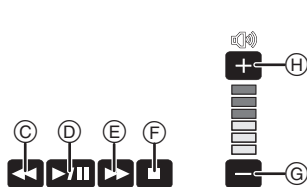

- (C) Fast rewind, Frame-by-frame rewind*2
 - (D) Play/Pause
 - (E) Fast forward, Frame-by-frame forward*2
 - (F) Stop
 - (G) Reduce volume level*1
 - (H) Increase volume level*1
- *1 You can also adjust the volume level by using the rear dial.

*2 These operations can be performed only in the Pause Mode and the following icons are displayed.

- Frame-by-frame rewind: [⏮]
- Frame-by-frame forward: [⏭]

• About fast forward/rewind playback

- Touch [▶] during playback to fast forward (touch [◀] to fast rewind). The fast forward/rewind speed increases if you touch [▶]/[◀] again. (The display on the screen changes from [▶▶] to [▶▶▶].)
- Touch [⏮] to resume normal playback speed.
- When using a high capacity card, it is possible that fast rewinding may be slower than usual.

 **Note**

- Sound can be heard through the speaker. Refer to [VOLUME] (P58) for information about how to adjust the volume in the [SETUP] menu.
- To play back the motion pictures recorded by this unit on a PC, use the "QuickTime" or the "PHOTOfunSTUDIO 6.0 BD Edition" software on the CD-ROM (supplied).
- QuickTime Motion JPEG motion pictures that were recorded with a PC or other equipment may have lower image quality or may not be able to play back with this unit.

[REC] Mode: **iA**

Taking Pictures using the Automatic Function

(**iA**): Intelligent Auto Mode)

The camera will set the most appropriate settings to match the subject and the recording conditions so we recommend this mode for beginners or those who want to leave the settings to the camera and take pictures easily.

Set the mode dial to **[iA]**.

- It will also switch to Intelligent Auto Mode by pressing [Fn1] button at the time of purchase. (P18)
- The following functions are activated automatically.
 - Scene Detection/[RED-EYE REMOVAL]/Face Detection/Intelligent ISO sensitivity control/[I.DYNAMIC]/[LONG SHTR NR]/Quick AF/[FOCUS PRIORITY]/Backlight Compensation/[I.RESOLUTION]
- In Intelligent Auto Mode, **[FOCUS PRIORITY] (P131) is fixed to [ON]. This means you cannot take pictures until the subject is in focus.**

Scene Detection

When the camera identifies the optimum scene, the icon of the scene concerned is displayed in blue for 2 seconds, after which its colour changes to the usual red.



When taking pictures

iA →		[i- PORTRAIT]
		[i- SCENERY]
		[i- MACRO]
		[i- NIGHT PORTRAIT]
		[i- NIGHT SCENERY]
		[i- SUNSET]
		[i- BABY]*

• Only when [**iA**] is selected

When recording motion pictures

iA →		[i- PORTRAIT]
		[i- SCENERY]
		[i- LOW LIGHT]
		[i- MACRO]

- [**iA**] is set if none of the scenes are applicable, and the standard settings are set.
- When [, , or] is selected, the camera automatically detects a person's face, and it will adjust the focus and exposure. (**Face Detection**) (P82)

- If a tripod is used, for instance, and the camera has judged that camera shake is minimal when the Scene Mode has been identified as [P2], the shutter speed will be slower than normal. Take care not to move the camera while taking pictures.
- An optimum scene for the specified subject will be chosen when set to AF tracking (P49).
- When [FACE RECOG.] is set to [ON], and the face similar to the registered face is detected, [R] is displayed in the top right of [P2], [P3] and [P4].
- * When [FACE RECOG.] is set to [ON], [P4] will be displayed for birthdays of registered faces already set only when the face of a person 3 years old or younger is detected.

Note

- Due to conditions such as the ones below, a different scene may be identified for the same subject.
 - Subject conditions: When the face is bright or dark, the size of the subject, the colour of the subject, the distance to the subject, the contrast of the subject, when the subject is moving
 - Recording conditions: Sunset, sunrise, under low brightness conditions, when the camera is shaken, when zoom is used
- To take pictures in an intended scene, it is recommended that you take pictures in the appropriate Recording Mode.
- **The Backlight Compensation**
 - Backlight refers to when light comes from the back of a subject. In this case, the subject will become dark, so this function compensates the backlight by brightening the whole of the picture automatically. Backlight compensation is automatically applied in Intelligent Auto Mode.

AF Tracking Function

It is possible to set the focus and exposure to the specified subject. Focus and exposure will keep following the subject automatically even if it moves.

■ When operating the touch panel

You can lock the subject by touching it.

- [P4] is displayed in the lower left of the screen.
- AF Tracking frame will be displayed in yellow, and it will determine the most appropriate scene for the locked subject.
- AF Tracking is cancelled when [CANCEL] is touched.



■ When operating buttons

1 Press and hold [Q.MENU] button until AF Tracking frame is displayed.

- [P4] is displayed in the lower left of the screen.
- AF Tracking frame is displayed in the centre of the screen.
- AF Tracking is cancelled when [MENU/SET] is pressed.



Q.MENU



2 Place the subject in the Tracking frame, and press the shutter button halfway to lock the subject.

- AF area will turn green when the camera detects the subject.
- AF tracking frame will turn yellow when you release the shutter button and the optimum scene for the locked subject will be identified.
- Press [MENU/SET] to cancel.



Note

- [FACE RECOG.] does not work during AF tracking.
- Use AF Tracking with the Touch Shutter function cancelled.
- Please read the Note regarding the AF tracking on P83.

Settings in Intelligent Auto Mode

■ [REC] Mode menu

[ASPECT RATIO] (P120)/[PICTURE SIZE] (P120)/[QUALITY] (P121)/[FACE RECOG.] (P109)/[STABILIZER]*¹ (P75)

*1 It cannot be set to [MODE3]. It will be fixed to [MODE1] when recording a motion picture even if it is set to [MODE2].

■ [MOTION PICTURE] Mode menu

[REC MODE] (P127)/[REC QUALITY]*² (P127)/[CONTINUOUS AF] (P43)/[WIND CUT] (P129)

*2 [] for [MOTION JPEG] cannot be set.

■ [CUSTOM] menu



[CUST. SET MEM.] (P105)/[GUIDE LINE] (P130)/[LCD INFO.DISP.] (P134)/[REMAINING DISP.] (P134)

■ [SETUP] menu

[CLOCK SET] (P31)/[WORLD TIME] (P116)/[BEEP] (P58)/[LCD MODE] (P59)/[LANGUAGE] (P62)

• Use the Quick Menu (P56) to set the following functions:

– [STANDARD] and [STANDARD] () in [FILM MODE] (P118)

– [] and [] in [SELF-TIMER]*³ (P81)

*3 It will be reset to [] when the Intelligent Auto Mode is cancelled or when the power is switched [ON]/[OFF].

- The settings of the following items are fixed.

Item	Settings
[ECONOMY] ([SLEEP MODE]) (P59)	[5MIN.]
Flash (P69)	[iA]/[i]
[FLASH SYNCHRO] (P123)	[1ST]
[BURST RATE] (P77)	[H] (High speed)
[AUTO BRACKET] (P79)	[□/□]SETTINGS: [□] (burst) [STEP]: [3•1/3] [SEQUENCE]: [0/-/+]
AF Mode (P82)	[i] (Set to [i] ^{*4} when a face cannot be detected)
[WHITE BALANCE] (P88)	[AWB]
[SENSITIVITY] (P91)	[iISO] ^{*5} (Intelligent ISO) (The maximum ISO sensitivity: [ISO800])
[METERING MODE] (P122)	[i]
[RED-EYE REMOVAL] (P70)	[ON]
[I.DYNAMIC] (P124)	[STANDARD]
[LONG SHTR NR] (P124)	[ON]
[COLOR SPACE] (P126)	[sRGB]
[PICTURE MODE] (P108)	[i]
[PRE AF] (P131)	[QAF]
[FOCUS PRIORITY] (P131)	[ON]
[AF ASSIST LAMP] (P132)	[ON]

- *4 It will be set to Multi Auto Focus Mode for motion pictures when a face cannot be detected while recording motion pictures.
- *5 The setting is fixed to [AUTO] (for motion pictures) when recording motion pictures.
- Depending on the scene detected, camera will automatically adjust the setting of the [I.RESOLUTION] (P123). [I.RESOLUTION] cannot be set via the [REC] Mode menu.
- The following functions cannot be used.
 - [AUTO LCD OFF] of [ECONOMY]/AF/AE lock/White Balance fine adjustment/White Balance Bracket/Multi Film Bracket/Flash output adjustment/[ISO LIMIT SET]/[EX. TELE CONV.]/[DIGITAL ZOOM]/[ASPECT BRACKET]/[HIGHLIGHT]/[AF/AE LOCK]/[AF/AE LOCK HOLD]/[DIRECT FOCUS AREA]/[SHOOT W/O LENS]
- The other items on the [SETUP] menu and [CUSTOM] menu can be set in a mode such as the Programme AE Mode. What is set will be reflected in the Intelligent Auto Mode.

■ Flash

- **Open the flash when the flash is to be used. (P69)**
- Flash modes cannot be switched using the menu in the Intelligent Auto Mode.
- [iA], [i], [i] or [i^S] is set depending on the type of subject and brightness.
- When [i] or [i] is displayed, the Digital red-eye correction is turned on.
- Shutter speed will be slow when using [i] or [i^S].

Deleting Pictures

Once deleted, pictures cannot be recovered.

Press [▶].

To delete a single picture

1 Select the picture to be deleted, and then press [▶].

- (A) [▶] button
- (B) [DISPLAY] button
- (C) [▶] button

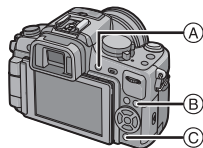

2 Press ◀ to select [YES] and then press [MENU/SET].



To delete multiple pictures (up to 100*) or all the pictures

* Burst group will be treated as a single picture. (All the pictures in the selected burst group will be deleted.)

1 Press [▶].

2 Press ▲/▼ to select [DELETE MULTI] or [DELETE ALL] and then press [MENU/SET].

- [DELETE ALL] → step 5.

3 Press ▲/▼/◀/▶ to select the picture, and then press [DISPLAY] to set.
(Repeat this step.)

- [▶] appears on the selected pictures. If [DISPLAY] is pressed again, the setting is cancelled.

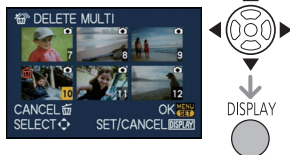

4 Press [MENU/SET].

5 Press ▲ to select [YES] and then press [MENU/SET] to set.

■ When [DELETE ALL] has been selected with the [FAVORITE] (P150) setting

The selection screen is displayed again. Select [DELETE ALL] or [ALL DELETE EXCEPT ★], press ▲ to select [YES] and delete the pictures.

Note

- Do not turn the camera off while deleting (while [] is displayed). Use a battery with sufficient battery power or the AC adaptor (DMW-AC8E; optional) and DC coupler (DMW-DCC8; optional).
- If you press [MENU/SET] while deleting pictures using [DELETE MULTI], [DELETE ALL] or [ALL DELETE EXCEPT ★], the deleting will stop halfway.
- Depending on the number of pictures to be deleted, it may take some time to delete them.
- If pictures do not conform to the DCF standard or are protected (P152), they will not be deleted even if [DELETE ALL] or [ALL DELETE EXCEPT ★] is selected.

Setting the Menu

This camera offers menu selections that allow you to customize its operation to maximise your picture taking experience.

In particular, the [SETUP] menu contains some important settings relating to the camera's clock and power. Check the settings of this menu before proceeding to use the camera.

<p>[REC] Mode menu (P118 to 126)</p> <ul style="list-style-type: none"> This menu lets you set the aspect ratio, number of pixels and other aspects of the pictures you are recording. 	<p>[SETUP] menu (P58 to 63)</p> <ul style="list-style-type: none"> This menu lets you perform the clock settings, select the operating beep tone settings and set other settings which make it easier for you to operate the camera.
<p>[MOTION PICTURE] Mode menu (P127 to 129)</p> <ul style="list-style-type: none"> This menu lets you set the [REC MODE], [REC QUALITY], and other aspects for motion picture recording. 	<p>MY [MY MENU]</p> <ul style="list-style-type: none"> Up to 5 menu items used recently can be memorised. Items used a lot can be recalled easily.
<p>[CUSTOM] menu (P130 to 136)</p> <ul style="list-style-type: none"> Operation of the unit, such as displaying of the screen and button operations, can be set up according to your preferences. Also, it is possible to register the modified settings. 	<p>[PLAYBACK] Mode menu (P141 to 153)</p> <ul style="list-style-type: none"> This menu lets you set the Protection, Cropping or Print Settings, etc. of recorded pictures.

Note

- There are functions that cannot be set or used depending on the modes or menu settings being used on the camera due to the specifications.

Setting menu items

This section describes how to select the [REC] Mode menu settings, and the same setting procedure can be used for the [MOTION PICTURE] Mode menu, [CUSTOM] menu, [SETUP] menu, [MY MENU] menu and [PLAYBACK] Mode menu as well.

- If you set [MENU RESUME] (P135) in the [CUSTOM] menu to [ON], the screen shows the last selected menu item when the camera was turned off.
- It is set to [ON] at the time of purchase.
- Menu item cannot be set with touch operation. Set with the cursor buttons or the rear dial.

Example: Setting [I.DYNAMIC] from [OFF] to [HIGH] in the Programme AE Mode

1 Set the mode dial to [P].

- (A) [MENU/SET] button

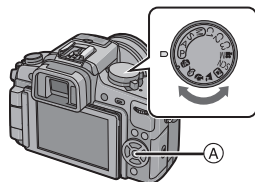

2 Press [MENU/SET] to display the menu.

- (B) Menu toggle icon
 (C) Menu item
 (D) Menu screen page
 (E) Settings

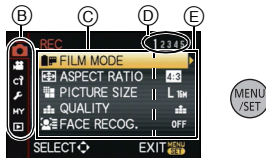

Switching to other menus

e.g.: Switching to the [SETUP] menu

1 Press ◀.



2 Press ▼ or rotate the rear dial to select the [SETUP] menu icon [⚙].

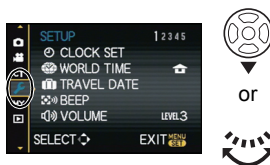

3 Press ▶ or the rear dial.

• Select a menu item next and set it.

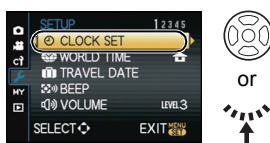

3 Press ▲/▼ or rotate the rear dial to select [I.DYNAMIC].

- Select the item at the very bottom, and press ▼ or rotate the rear dial right to move to the next screen.



4 Press ► or the rear dial.

- Depending on the item, its setting may not appear or it may be displayed in a different way.

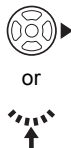

5 Press ▲/▼ or rotate the rear dial to select [HIGH].



6 Press [MENU/SET] or the rear dial to set.

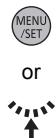

7 Press [MENU/SET] to close the menu.

- You can also press the shutter button halfway to close the menu.

Setting the Quick Menu

By using the Quick Menu, some of the menu settings can be easily found.

- The features that can be adjusted using Quick Menu are determined by the mode or a display style the camera is in.

■ When operating the touch panel

Setting of the Quick Menu can be set using the touch panel.

1 Touch [Q.MENU] to display the Quick Menu in recording status.



2 Touch the menu item and the setup.

- (A) Item
- (B) Settings

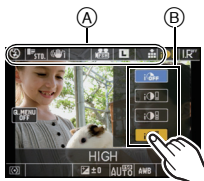

3 Touch [Q.MENU OFF] to close the Quick Menu.

■ When operating buttons

The Quick Menu can be set by pressing the [Q.MENU] button.

To close the Quick Menu, press [Q.MENU] button again.

- Setup method is different depending on the displayed screen during recording.
- Refer to P64 about the displayed screen.

[] (LCD monitor style)

After selecting the items with ◀/▶, you can select the setting contents with ▲/▼. Set by pressing [MENU/SET].

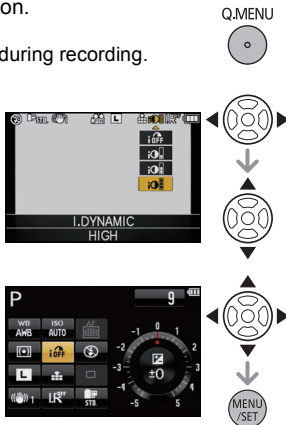

LCD recording information display in [] (LCD monitor style)

Select the item with ▲/▼/◀/▶, press [MENU/SET], and then select the setting contents with ▲/▼/◀/▶. Set by pressing [MENU/SET].

- You can also use the rear dial to set.



- You can change the settings by directly touching the items, without displaying the Quick Menu.



[] (Finder style)

Select the item by rotating the rear dial, and then press the rear dial. Select the setting contents by rotating the rear dial, and then press the rear dial to set.

- You can also press ◀/▶ and [MENU/SET] to set.



Perform these settings if you need to.

About the Setup Menu

[CLOCK SET], [ECONOMY] and [AUTO REVIEW] are important items. Check their settings before using them.

For details on how to select the [SETUP] menu settings, refer to P55.

[CLOCK SET]	—
-------------	---

- Refer to P31 for details.

[WORLD TIME]	[DESTINATION]/ [HOME]
--------------	-----------------------

- Refer to P116 for details.

[TRAVEL DATE]	[TRAVEL SETUP]/[LOCATION]
---------------	---------------------------

- Refer to P115 for details.

[BEEP]	Set the volume for electronic noises and the electronic shutter noise.	
	[BEEP VOLUME]: (Muted) (Low) (High)	[E-SHUTTER VOL]: (Muted) (Low) (High)

- The [E-SHUTTER VOL] only works when set to [SH] for Burst Mode.

[VOLUME]	Adjust the volume of the speaker to any of 7 levels.
----------	------------------------------------------------------

- When you connect the camera to a TV, the volume of the TV speakers does not change.

[MONITOR]/ [VIEWFINDER]	Brightness, colour, or red or blue tint of the LCD monitor/ viewfinder is adjusted.
----------------------------	----------------------------------------------------------------------------------------

- Adjust the brightness of the screen with ▲/▼, contrast and saturation with ◀/▶ or the rear dial.
- When [DISPLAY] is pressed in screen shown right, it will switch to the colour adjustment screen. Adjust between green and red with ▲/▼, or between orange and blue with ◀/▶ or the rear dial. Press [MENU/SET] to return to the LCD adjustment screen.
- It will adjust the LCD monitor when the LCD monitor is in use, and the viewfinder when the viewfinder is in use.
- Some subjects may appear differently from actuality on the LCD monitor/viewfinder. However, this does not affect the recorded pictures.

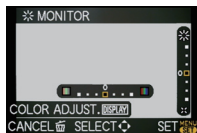



LCD [LCD MODE]	The brightness of the LCD monitor can be adjusted depending on how bright it is around the camera.
	<p>[A]* [AUTO]: The brightness is adjusted automatically depending on how bright it is around the camera.</p> <p>[1]* [MODE1]: Make the LCD monitor brighter.</p> <p>[2]* [MODE2]: Set the LCD monitor to the standard brightness.</p> <p>[3]* [MODE3]: Make the LCD monitor darker.</p>





- The brightness of the pictures displayed on the LCD monitor is increased so some subjects may appear differently from actuality on the LCD monitor. However, this does not affect the recorded pictures.
- The LCD monitor automatically returns to standard brightness after 30 seconds when recording in [MODE1]. Press any button to make the LCD monitor bright again.
- If the screen is difficult to see because of light from the sun etc. shining on it, use your hand or another object to block the light.
- The number of recordable pictures decreases in [AUTO] and [MODE1].
- [AUTO] cannot be selected when playing back pictures.
- [AUTO] is disabled during motion picture recording.
- When the menu screen is displayed in a dark environment etc., the LCD monitor becomes darker even if [LCD MODE] is set to [MODE2].
- The initial setting when using the AC adaptor (DMW-AC8E; optional) is [MODE2].

ECO [ECONOMY]	You can conserve the battery life by setting these menus. Also, it will turn off the LCD monitor automatically when not in use to prevent discharge of the battery.
	<p>[Z] [SLEEP MODE]: The camera is automatically turned off if the camera has not been used for the time selected on the setting. [OFF]/[1MIN.]/[2MIN.]/[5MIN.]/[10MIN.]</p>
	<p>[OFF] [AUTO LCD OFF]: The LCD monitor is automatically turned off if the camera has not been used for the time selected on the setting. [OFF]/[15SEC.]/[30SEC.]</p>

- Press the shutter button halfway or turn the camera off and on to cancel [SLEEP MODE].
- [SLEEP MODE] is set to [5MIN.] in the Intelligent Auto Mode.
- [SLEEP MODE] is fixed to [2MIN.] when [AUTO LCD OFF] is set to [15SEC.] or [30SEC.].
- Press any button to turn on the LCD monitor again.
- Since [ECONOMY] is cancelled when the eye sensor auto switching is performed, it is recommended to use this mode with [AUTO SWITCH] in [LVF/LCD SWITCH] (P134) set to [OFF].
- [SLEEP MODE] does not work in the following cases.
 - When using the AC adaptor
 - When connecting to a PC or a printer
 - When recording or playing back motion pictures
 - During a slide show

 [AUTO REVIEW]	Set the length of time that the picture is displayed after taking it.
	[OFF]/[1SEC.]/[3SEC.]/[5SEC.] [HOLD]: The pictures are displayed until shutter button is pressed halfway.

- If it is set to [HOLD] when the camera is set to [] (P35) or [] (P81), switching of the playback screen display (P40) or enlargement by rotating the rear dial is possible during Auto Review.
- Regardless of the Auto Review setting, pictures will automatically be reviewed when taking burst pictures with [SH] or [H] set (P77), and recording with Auto Bracket (P79) or with [ASPECT BRACKET] (P125). (Will not hold) Also, you cannot set the Auto Review function.
- If [HIGHLIGHT] (P130) is set to [ON], white saturated areas appear blinking in black and white when the Auto Review function is activated.
- When [AUTO REGISTRATION] in [FACE RECOG.] (P109) is set to [ON], [AUTO REVIEW] can only be set to [3SEC.] or [5SEC.].

 [USB MODE]	Select the USB communication system after or before connecting the camera to your PC or your printer with the USB connection cable (supplied).
	 [SELECT ON CONNECTION]: Select either [PC] or [PictBridge(PTP)] if you connected the camera to a PC or a printer supporting PictBridge.  [PictBridge(PTP)]: Set after or before connecting to a printer supporting PictBridge.  [PC]: Set after or before connecting to a PC.

- When [PC] is selected, the camera is connected via the “USB Mass Storage” communication system.
- When [PictBridge(PTP)] is selected, the camera is connected via the “PTP (Picture Transfer Protocol)” communication system.

 [VIDEO OUT]	Set to match the colour television system in each country.
	[NTSC]: Video output is set to NTSC system. [PAL]: Video output is set to PAL system.

- This will operate when the AV cable or HDMI mini cable (optional) is connected.

 [TV ASPECT]	Set to match the type of TV.
	[16:9]: When connecting to a 16:9 screen TV. [4:3]: When connecting to a 4:3 screen TV.

- This will work when the AV cable is connected.

HDMI [HDMI MODE]	Set the format for the HDMI output when playing back on the HDMI compatible high-definition TV connected with this unit using the HDMI mini cable (optional).
	<p>[AUTO]: The output resolution is automatically set based on the information from the connected TV.</p> <p>[1080i]: The interlace method with 1080 available scan lines is used for output.</p> <p>[720p]: The progressive method with 720 available scan lines is used for output.</p> <p>[576p]^{*1}/[480p]^{*2}: The progressive method with 576^{*1}/480^{*2} available scan lines is used for output.</p>

*1 When [VIDEO OUT] is set to [PAL]

*2 When [VIDEO OUT] is set to [NTSC]

- If the images are not output on the TV when the setting is [AUTO], match with the image format your TV can display, and select the number of effective scanning lines. (Please read the operating instructions for the TV.)
- This will work when the HDMI mini cable (optional) is connected.
- Refer to P158 for details.

VIERA Link [VIERA Link]	Setup so this unit can be controlled by the remote control of the VIERA equipment by automatically coupling this unit with the VIERA Link compatible equipment using HDMI mini cable (optional).
	<p>[OFF]: Operation is performed with the buttons on this unit.</p> <p>[ON]: Remote control operation of the VIERA Link compatible equipment is enabled. (Not all operations are possible) Button operation of the main unit will be limited.</p>









• This will work when the HDMI mini cable (optional) is connected.

• Refer to P159 for details.

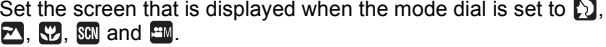
[3D] [3D PLAYBACK]	Setup the output method for 3D pictures.
	<p>[3D]: Set when connecting to a 3D compatible television.</p> <p>[2D]: Set when connecting to a television not compatible with 3D. Set this when you would like to view pictures in 2D (conventional image) on a 3D compatible television.</p>

• This will work when the HDMI mini cable (optional) is connected.

• Refer to P155 for the method to playback 3D pictures in 3D.

★ [FAVORITE FUNC.]	Marks can be added to pictures, and set up as favourites. [OFF]/[ON]
<ul style="list-style-type: none"> When it is set to [ON], you can set/cancel favourites by pressing ▼ during playback. You can also set favourites from the playback menu. For details, refer to P150. 	
 [MENU GUIDE]	Set the screen that is displayed when the mode dial is set to  [OFF]: The recording screen in the currently selected Advanced Scene Mode (P97), Scene Mode (P99) or Creative Motion Picture Mode (P106) appears. [AUTO]: The Advanced Scene Mode, Scene Mode or Creative Motion Picture Mode menu screen appears.
 [CALIBRATION]	Adjust the position of the touch panel if a different thing gets selected from what you touched or touch operation does not respond. <ol style="list-style-type: none"> Press [MENU/SET]. Touch the orange [+] mark displayed on the screen in order with the stylus pen (supplied) (5 places). <ul style="list-style-type: none"> A message is displayed once the position is set. Press [MENU/SET] to finish. 
<ul style="list-style-type: none"> Calibration is not done if correct position is not touched. Touch the [+] mark again. 	
 [LANGUAGE]	Set the language displayed on the screen. [ENGLISH]/[DEUTSCH]/[FRANÇAIS]/[ESPAÑOL]/[ITALIANO]/[日本語]
<ul style="list-style-type: none"> If you set a different language by mistake, select  from the menu icons to set the desired language. 	
 [VERSION DISP.]	This enables the firmware versions of the camera and lens to be checked.
<ul style="list-style-type: none"> [-. -] is displayed as the lens firmware when the lens is not mounted. 	

 [NO.RESET]	Reset the file number of the next recording to 0001.
--------------------------------------------------------------------------------------------------	------------------------------------------------------

- The folder number is updated and the file number starts from 0001. (P166)
- A folder number between 100 and 999 can be assigned.
When the folder number reaches 999, the number cannot be reset. We recommend formatting the card (P63) after saving the data on a PC or elsewhere.
- To reset the folder number to 100, format the card first and then use this function to reset the file number.
A reset screen for the folder number will then appear. Select [YES] to reset the folder number.

 [RESET]	The [REC] or [SETUP]/[CUSTOM] menu settings are reset to the initial settings.
-------------------------------------------------------------------------------------------------	--------------------------------------------------------------------------------

- When the [REC] Mode settings are reset, data registered with [FACE RECOG.] will also be reset.
- When [SETUP]/[CUSTOM] menu settings are reset, the following settings are also reset. In addition, [ROTATE DISP.] (P149) in [PLAYBACK] Mode menu is set to [ON].
 - The birthday and name settings for [BABY1]/[BABY2] (P101) and [PET] (P102) in Scene Mode.
 - The settings of [TRAVEL DATE] (P115) (departure date, return date, location)
 - The [WORLD TIME] (P116) setting.
- The folder number and the clock setting are not changed.

 [FORMAT]	The card is formatted. Formatting permanently deletes all data on your memory card. Please be sure all pictures and motion pictures are saved elsewhere before using this feature.
--------------------------------------------------------------------------------------------------	----------------------------------------------------------------------------------------------------------------------------------------------------------------------------------------------

- Use a battery with sufficient battery power or the AC adaptor (DMW-AC8E; optional) and DC coupler (DMW-DCC8; optional) when formatting. Do not turn the camera off during formatting.
- If the card has been formatted on a PC or other equipment, format it on the camera again.
- If the card cannot be formatted, please try another card before contacting your nearest Service Centre.

Switching the Display of the LCD Monitor/ Viewfinder

Switching the Information Displayed on the recording screen

Press [DISPLAY] to change.

Ⓐ [DISPLAY] button

- When the menu screen appears, the [DISPLAY] button is not activated.

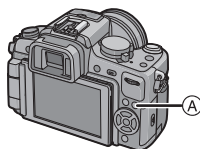

(LCD monitor display)

• Screens here are an example of when it is set to [] (LCD monitor style).

With the [LCD DISP.STYLE] of the [CUSTOM] menu, you can choose the displayed screen on the LCD monitor to display in [] (LCD monitor style) or [] (viewfinder style).

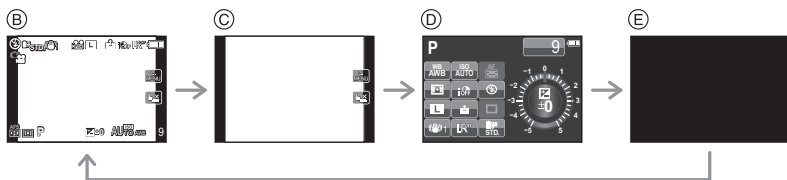

Ⓑ Normal display*1, 2

Ⓒ No display*1

Ⓓ [LCD INFO.DISP.]*3

Ⓔ Turned off

(Viewfinder display)

• Screens here are an example of when it is set to [] (viewfinder style).

With the [LVF DISP.STYLE] of the [CUSTOM] menu, you can choose the displayed screen on the viewfinder to display in [] (viewfinder style) or [] (LCD monitor style).

Ⓕ Normal display+detailed information*1, 2

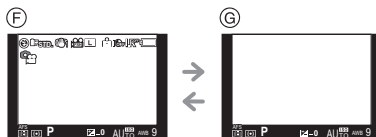

Ⓖ Normal display*1



- *1 Guide lines are displayed when the [GUIDE LINE] of the [CUSTOM] menu is set to anything except [OFF].
- *2 Histograms are displayed when the [HISTOGRAM] of the [CUSTOM] menu is set to [ON]. It is also possible to display the Exposure meter by setting the [EXPO.METER] of the [CUSTOM] menu to [ON]. (P133)
- *3 It is displayed when the [LCD INFO.DISP.] of the [CUSTOM] menu is set to anything except [OFF]. (P134)

■ Recording guide line

When you align the subject on the horizontal and vertical guide lines or the cross point of these lines, you can take pictures with well-designed composition by viewing the size, the slope and the balance of the subject.

- (A) : This is used when dividing the entire screen into 3×3 for taking pictures with a well-balanced composition.
- (B) : This is used when you want to position the subject at the exact centre of the screen.
- (C) : Position of the guide line can be set. It is used to take well balanced pictures of subjects off the centre of the image.

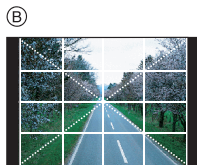

■ Set the position of the guide line with

- Set the [GUIDE LINE] in the [CUSTOM] menu to .

Touch  above the guide line, and drag it to the position you want to move it to (P16).

- You can also set the position of the guide line with the cursor button in the Quick Menu (P57) while in button operation or [CUSTOM] menu.
- When it is difficult to move the guide line on the screen edge by touch operation, use the cursor button to set the position.

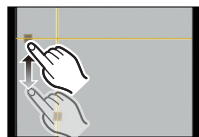

■ About the Histogram

A histogram is a graph that displays brightness along the horizontal axis (black to white) and the number of pixels at each brightness level on the vertical axis. It allows you to easily check a picture's exposure.

Examples of histogram

- 1 Properly Exposed
 - 2 Under Exposed
 - 3 Overexposed
- * Histogram

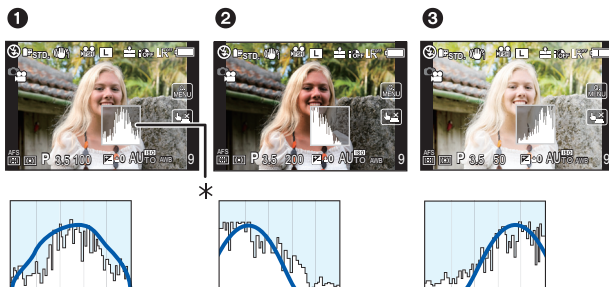

■ Set the position of the histogram

- Set the [HISTOGRAM] in the [CUSTOM] menu to [ON].

Touch the histogram and drag it to the position you want to move it to (P16).

- You can also set the position of the histogram with the cursor button in the Quick Menu (P57) while in button operation or [CUSTOM] menu.

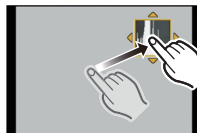

Note

- **When the recorded picture and the histogram do not match each other under the following conditions, the histogram is displayed in orange.**
 - When the manual exposure assistance is other than $[\pm 0]$ during Exposure Compensation or in the Manual Exposure Mode
 - When the flash is activated
 - When the flash is closed
 - When the brightness of the screen is not correctly displayed in dark places
 - When the exposure is not adequately adjusted
- The histogram is an approximation in the Recording Mode.
- The histogram displayed in this camera does not match histograms displayed by picture editing software used in PCs etc.

[REC] Mode: **IA** **P** **A** **S** **M** **1** **2** **3** **SCN**    

Taking Pictures with the Zoom

Using the Optical Zoom/Using the Extra Tele Conversion (EX)/ Using the Digital Zoom

[You can only use the Optical Zoom in **[IA]**, and the Optical Zoom, the Extra Tele Conversion in **[SCN]**, **[**], **[**] and **[**] mode.]

You can zoom-out to record landscapes etc. in wide angle (Wide) or zoom-in to make people and objects appear closer (Tele) by turning the zoom ring.

To enlarge further, set the [EX. TELE CONV.] to [ON] or the [DIGITAL ZOOM] to [2×] or [4×] in the [REC] Mode menu or the [MOTION PICTURE] Mode menu. Then you can take larger photos.

When [EX. TELE CONV.] (max. 2×) is used in still picture recording, set each image aspect ratio (**4:3** / **3:2** / **16:9** / **1:1**) to a picture size other than [L] [picture size with **EX** (P120)].

■ Types of zooms

Feature	Optical Zoom	Extra Tele Conversion (EX)	Digital Zoom
Recording magnification	When the 14–140 mm/F4.0–5.8 lens supplied in DMC-GH2H is used		
	10×	when taking still pictures: 2× ^{*1} when recording motion pictures: 4.8× ^{*2}	[2×]
			[4×]
	When the 14–42 mm/F3.5–5.6 lens supplied in DMC-GH2K is used		
3×	when taking still pictures: 2× ^{*1} when recording motion pictures: 4.8× ^{*2}	[2×]	
		[4×]	
Picture quality	No deterioration	No deterioration	The higher the magnification level, the greater the deterioration.

*1 When a picture size of [S] (4 M), aspect ratio of **[4:3]** is selected.

The magnification level differs depending on [PICTURE SIZE] and [ASPECT RATIO] setting.

*2 When recording quality setting [$\frac{H}{VGA}$] or [$\frac{H}{QVGA}$] is selected.

When Recording Mode [AVCHD(1080i)] is selected, Extra Tele Conversion factor will change to 2.6.

When Recording Mode [AVCHD(720p)] is selected, or Recording Mode [MOTION JPEG] is selected with recording quality setting [$\frac{H}{HD}$] or [$\frac{H}{WVGA}$], Extra Tele Conversion factor will change to 3.9.

Example: When the 14–42 mm/F3.5–5.6 lens supplied with the DMC-GH2K is used, you can achieve 24× magnification by 3× Optical Zoom + 2× Extra Tele Conversion + 4× Digital Zoom.

 **Note**

- With the Extra Tele Conversion, for example, when it is set to [EXS] (equal to 4 million pixels), it will take the picture using the 4 million pixels in the centre out of the 16 million pixels of the imaging device, resulting to be more of a telephoto picture.
- When the Extra Tele Conversion is used, angle of view for still pictures will be different from the angle of view for motion pictures because the zoom factor is different between them. Angle of view for recording can be checked beforehand by matching the [REC AREA] (P134) setting to the mode you wish to record in.
- If you use the zoom function after focusing on the subject, focus on the subject again.
- When using the Digital Zoom, [STABILIZER] may not be effective.
- If camera shake (jitter) is a problem during Digital Zooming, it is recommended that [STABILIZER] be set to [MODE1].
- When using the Digital Zoom, we recommend using a tripod and the self-timer (P81) for taking pictures.
- The AF Mode is fixed to [AF] when using the Digital Zoom.
- The Extra Tele Conversion and Digital zoom cannot be used in the following cases.
 - When [QUALITY] is set to [RAW], [RAW] or [RAW]

[REC] Mode: **P A S M C1 C2 C3 SCN**  

Taking Pictures using the Built-in Flash

(A) To open the flash
Slide the flash open lever.

(B) To close the flash
Press the flash until it clicks.

- Be sure to close the flash when not in use.
- The flash setting is fixed to  while the flash is closed.

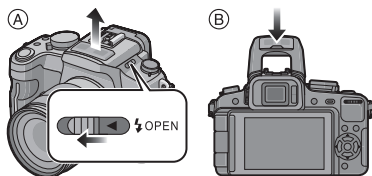

Note

- Be careful not to catch a finger when closing a flash bulb.

Switching to the appropriate flash setting

Applicable modes: **P A S M C1 C2 C3 SCN**  

Set the built-in flash to match the recording.

- Open the flash.

- 1** Select **[FLASH]** in the **[REC] Mode** menu. (P55)
- 2** Press **▲/▼** to select a mode and press **[MENU/SET]**.
 - For information about flash settings that can be selected, refer to “Available flash settings by Recording Mode”. (P71)

Item	Description of settings
A: AUTO	The flash is automatically activated when the recording conditions make it necessary.
A⊙: AUTO/Red-Eye Reduction*	The flash is automatically activated when the recording conditions make it necessary. It is activated once before the actual recording to reduce the red-eye phenomenon (eyes of the subject appearing red in the picture) and then activated again for the actual recording. • Use this when you take pictures of people in low lighting conditions.
: Forced Flash ON	The flash is activated every time regardless of the recording conditions. • Use this when your subject is back-lit or under fluorescent light.
⊙: Forced ON/Red-Eye Reduction*	The flash is activated every time regardless of the recording conditions. Simultaneously it reduces the red-eye phenomenon. • Use this when your subject is back-lit or under fluorescent light.
S: Slow Sync.	When taking pictures against a dark background landscape, this feature will slow the shutter speed when the flash is activated. Dark background landscape will appear brighter. • Use this when you take pictures of people in front of a dark background. • Using a slower speed can cause motion blur. Using a tripod can enhance your photos.
S⊙: Slow Sync./Red-Eye Reduction*	When taking pictures against a dark background landscape, this feature will slow the shutter speed when the flash is activated. Dark background landscape will appear brighter. Simultaneously it reduces the red-eye phenomenon. • Use this when you take pictures of people in front of a dark background. • Using a slower speed can cause motion blur. Using a tripod can enhance your photos.
S: Forced Flash OFF	The flash is not activated in any recording conditions. • Use this when you take pictures in places where the use of the flash is not permitted. • Close the flash to turn it off when the built-in flash is used.

The flash is activated twice. The interval between the first and second flash is longer when [A⊙], [⊙] or [S⊙] is set. The subject should not move until the second flash is activated.

* [RED-EYE REMOVAL] on the [REC] Mode menu is set to [ON], [] appears on the flash icon.

■ About the Digital Red-Eye Correction

When [RED-EYE REMOVAL] on the [REC] Mode menu has been set to [ON] and Red-Eye Reduction ([A⊙], [⊙], [S⊙]) is selected, Digital Red-Eye Correction is performed whenever the flash is used. The camera automatically detects red-eye and corrects the picture. (Only available when the AF Mode is set to []) and Face Detection is active)

• Under certain circumstances, red-eye cannot be corrected.

■ Available flash settings by Recording Mode

The available flash settings depend on the Recording Mode.

(○: Available, —: Not available, ●: Initial setting of Advanced Scene Mode and Scene Mode)

	⚡A	⚡AⓄ	⚡	⚡Ⓞ	⚡S	⚡SⓄ	Ⓞ		⚡A	⚡AⓄ	⚡	⚡Ⓞ	⚡S	⚡SⓄ	Ⓞ	
	○*	—	—	—	—	—	—	○		—	—	—	—	—	—	●
	○	○	○	○	○	○	○	○		●	—	○	—	—	—	○
	○	○	○	○	○	○	○	○		●	—	○	—	—	—	○
	○	○	○	○	—	—	○	○		●	—	○	—	—	—	○
	—	—	○	○	—	—	○	○		●	—	○	—	—	—	○
	—	—	—	—	—	—	○	○		●	—	○	—	—	—	○
	—	—	—	—	—	—	○	○		●	○	○	—	—	—	○
	○	●	○	—	—	—	○	○		—	—	—	—	—	●	○
	○	●	○	—	—	—	○	○		—	—	—	—	—	●	○
	●	○	○	—	—	—	○	○		—	—	○	—	●	○	○
	○	●	○	—	—	—	○	○		●	—	○	—	—	—	○
	○	●	○	—	—	—	○	○		○	●	○	—	—	—	○
	—	—	—	—	—	—	○	○		○	●	○	—	—	—	○
	—	—	—	—	—	—	○	○		●	—	○	—	—	—	○
	—	—	—	—	—	—	○	○		●	—	○	—	—	—	○
	—	—	—	—	—	—	○	○		●	—	○	—	—	—	○

* [] is displayed. [], [], [] or [] is set depending on the type of subject and brightness.

- The flash setting may change if the Recording Mode is changed. Set the flash setting again if necessary.
- The flash setting is memorised even if the camera is turned off. However, the Advanced Scene Mode or the Scene Mode flash setting is reset to the initial setting when the Advanced Scene Mode or the Scene Mode is changed.
- Flash will not be activated when recording motion picture.

■ The available flash range to take pictures

- The available flash range is an approximation.

ISO sensitivity	When the 14–140 mm/F4.0–5.8 lens supplied in DMC-GH2H is used		
	Available flash range according to focal length of lens (When the aspect ratio is [4:3] or [3:4].)		
	Wide to 21 mm	22 mm	Tele
AUTO	Vignetting effect occurs due to the light of the flash.	1.0 m (3.28 feet) to 4.8 m (15.7 feet) ⁺	50 cm (1.64 feet) to 3.7 m (12.1 feet) ⁺
ISO160		1.0 m (3.28 feet) to 3.0 m (9.84 feet)	50 cm (1.64 feet) to 2.3 m (7.55 feet)
ISO200		1.0 m (3.28 feet) to 3.4 m (11.2 feet)	50 cm (1.64 feet) to 2.6 m (8.53 feet)
ISO400		1.0 m (3.28 feet) to 4.8 m (15.7 feet)	50 cm (1.64 feet) to 3.7 m (12.1 feet)
ISO800		1.0 m (3.28 feet) to 6.9 m (22.6 feet)	50 cm (1.64 feet) to 5.3 m (17.4 feet)
ISO1600		1.0 m (3.28 feet) to 9.7 m (31.8 feet)	50 cm (1.64 feet) to 7.5 m (24.6 feet)
ISO3200		1.0 m (3.28 feet) to 13.8 m (45.3 feet)	60 cm (1.97 feet) to 10.7 m (35.1 feet)
ISO6400		1.2 m (3.94 feet) to 14.5 m (47.6 feet)	90 cm (2.95 feet) to 15.1 m (49.5 feet)
ISO12800		1.7 m (5.58 feet) to 27.6 m (90.6 feet)	1.3 m (4.27 feet) to 21.4 m (70.2 feet)

ISO sensitivity	When the 14–42 mm/F3.5–5.6 lens supplied in DMC-GH2K is used	
	Available flash range	
	Wide	Tele
AUTO	45 cm (1.48 feet) to 6.2 m (20.3 feet) ⁺	30 cm (0.99 feet) to 3.9 m (12.8 feet) ⁺
ISO160	45 cm (1.48 feet) to 3.9 m (12.8 feet)	30 cm (0.99 feet) to 2.4 m (7.87 feet)
ISO200	45 cm (1.48 feet) to 4.4 m (14.4 feet)	30 cm (0.99 feet) to 2.7 m (8.85 feet)
ISO400	45 cm (1.48 feet) to 6.2 m (20.3 feet)	30 cm (0.99 feet) to 3.9 m (12.8 feet)
ISO800	50 cm (1.64 feet) to 8.8 m (28.9 feet)	30 cm (0.99 feet) to 5.5 m (18.0 feet)
ISO1600	80 cm (2.62 feet) to 12.5 m (41.0 feet)	50 cm (1.64 feet) to 7.8 m (25.6 feet)
ISO3200	1.1 m (3.61 feet) to 17.7 m (58.1 feet)	70 cm (2.29 feet) to 11.1 m (36.4 feet)
ISO6400	1.6 m (5.25 feet) to 25.1 m (82.3 feet)	1.0 m (3.28 feet) to 15.7 m (51.5 feet)
ISO12800	2.2 m (7.22 feet) to 35.5 m (116.5 feet)	1.4 m (4.59 feet) to 22.2 m (72.8 feet)

* When the [ISO LIMIT SET] (P124) is set to [OFF]

- At the time of flash photography, when distance with the subject is near, the flash light is interrupted with the lens and a part of the picture being taken becomes dark. Check the distance between the camera and the subject when taking a picture. The distance from which the subject blocks the flash light differs according to the lens used.
 - When the 14–140 mm/F4.0–5.8 lens supplied in DMC-GH2H is attached:
 - When the aspect ratio is [4:3] or [16:9].
 - Vignetting effect occurs due to the light of the flash. (Wide to 21 mm)/1.0 m (3.28 feet) or less (22 mm)/50 cm (1.64 feet) or less (Tele)
 - When the aspect ratio is [3:2].
 - Vignetting effect occurs due to the light of the flash. (Wide to 17 mm)/1.0 m (3.28 feet) or less (18 mm)/50 cm (1.64 feet) or less (Tele)
 - When the aspect ratio is [16:9].
 - 2.5 m (8.20 feet) or less (Wide)/1.0 m (3.28 feet) or less (15 mm)/50 cm (1.64 feet) or less (Tele)
 - When the 14–42 mm/F3.5–5.6 lens supplied in DMC-GH2K is attached:
 - 45 cm (1.48 feet) or less (Wide)/30 cm (0.99 feet) or less (Tele)

■ Shutter speed for each flash setting

Flash setting	Shutter speed (Sec.)
	1/60*1 to 1/4000th
	1/60*2 to 1/160th

Flash setting	Shutter speed (Sec.)
	1 to 1/4000th
	60*3 to 1/4000th

*1 This becomes 60 seconds in Shutter-Priority AE Mode.

*2 This becomes 60 seconds in Shutter-Priority AE Mode and B (Bulb) in the Manual Exposure Mode.

*3 This becomes B (Bulb) in the Manual Exposure Mode.

- When the flash is activated, the shutter speed cannot be set to faster than 1/160th of a second.
- In Intelligent Auto Mode, shutter speed changes depending on the identified scene.

Note

- **Do not bring the flash too close to objects or close the flash while it is activated. The objects may be discoloured by its heat or lighting.**
- Do not close the flash soon after the flash is activated prior to taking pictures due to AUTO/Red-Eye Reduction etc. It causes a malfunction.
- When you take a picture beyond the available flash range, the exposure may not be adjusted properly and the picture may become bright or dark.
- When the flash is being charged, the flash icon blinks red, and you cannot take a picture even when you press the shutter button fully.
- When you take a picture beyond the available flash range, the White Balance may not be properly adjusted.
- **When you use certain lenses, light from the flash may be blocked or fail to cover the lens field of view, causing dark areas to appear in the resulting pictures.**
- When taking pictures with flash with the lens hood attached, the lower portion of the photo may turn dark (vignetting effect) and the control of the flash may be disabled because the photo flash may be obscured by the lens hood. We recommend detaching the lens hood.
- It may take time to charge the flash if you repeat taking a picture. Take a picture after the access indication disappears.
- The Red-Eye Reduction effect differs between people. Also, if the subject was far away from the camera or was not looking at the first flash, the effect may not be evident.
- When you attach an external flash, it takes priority over the built-in flash. Refer to P171 for the external flash.

Adjust the flash output

Applicable modes: **P A S M C1 C2 C3 SCN**    

Adjust the flash output if the recorded pictures are too bright or too dark.

1 Select **[FLASH ADJUST.]** in the **[REC] Mode menu. (P55)**

2 Press **◀/▶** to set the flash output and then press **[MENU/SET]**.

- You can adjust from $[-2 \text{ EV}]$ to $[+2 \text{ EV}]$ in steps of $[1/3 \text{ EV}]$.
- Select $[0 \text{ EV}]$ to return to the original flash output.



Note

- $[+]$ or $[-]$ is displayed on the flash icon in the screen when the flash level is adjusted.

[REC] Mode: **P A S M C1 C2 C3**  **SCN**    

Optical Image Stabilizer

Using one of these modes, jitter during picture taking is detected, and the camera automatically compensates the jitter, enabling jitter-free images to be taken.

The lens supplied in DMC-GH2H/DMC-GH2K has a stabilizer function.

- There is an [O.I.S.] switch on the 14–140 mm/F4.0–5.8 lens supplied in DMC-GH2H.
- There is no [O.I.S.] switch on the 14–42 mm/F3.5–5.6 lens supplied in DMC-GH2K. Set the [STABILIZER] settings in the [REC] Mode menu.

When using a lens with an [O.I.S.] switch, it is possible to set to enable the Optical Image Stabilizer by switching the [O.I.S.] switch on the lens to [ON]. (It is set to [MODE1] at the time of purchase.)

Example when a lens with the [O.I.S.] switch is mounted.

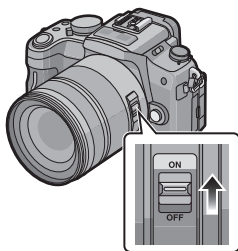

■ Setting the Stabilizer in the [REC] Mode menu

- 1 Select [STABILIZER] in the [REC] Mode menu. (P55)
- 2 Press ▲/▼ to select the setting and then press [MENU/SET].

- [OFF]:** [STABILIZER] does not work.
(This can be selected only when using a lens without the [O.I.S.] switch.)
- [MODE1]:** Jitter is always compensated during [REC] Mode.
- [MODE2]:** The jitter is compensated for when the shutter button is pressed.
- [MODE3]:** Camera shake is corrected for up/down movements. This mode is ideal for panning (a method of taking pictures which involves turning the camera to track the movements of a subject which continues to move in a fixed direction).

- When recording a motion picture, [STABILIZER] will be fixed to [MODE1] even if it is set to [MODE2] or [MODE3].
- [STABILIZER] cannot be selected when a lens without Stabilizer function is used.

■ Preventing jitter (camera shake)

When the jitter alert () appears, use [STABILIZER], a tripod, the self-timer (P81) or the remote shutter (DMW-RSL1; optional) (P172).

- Shutter speed will be slower particularly in the following cases. Keep the camera still from the moment the shutter button is pressed until the picture appears on the screen. We recommend using a tripod.
 - Slow Sync.
 - Slow Sync./Red-Eye Reduction
 - [NIGHT PORTRAIT], [NIGHT SCENERY] and [PARTY] in Scene Mode (P99)
 - When you set to a slow shutter speed

Note

- It is recommended to disable the Optical Image Stabilizer when using a tripod. () is displayed on the screen at that time.
- The stabilizer function may not be effective in the following cases.
 - When there is a lot of jitter.
 - When the zoom magnification is high.
 - When using the Digital Zoom.
 - When taking pictures while following a moving subject.
 - When the shutter speed becomes slower to take pictures indoors or in dark places.
 Be careful of camera jitter when you press the shutter button.
- The panning effect in [MODE3] is more difficult to achieve in the following cases.
 - In brightly lit places such as in broad daylight on a summer's day
 - When the shutter speed is faster than 1/100th of a second.
 - When you move the camera too slowly because the subject is moving slowly. (The background will not become a blur.)
 - When the camera does not keep up with the subject satisfactorily
- We recommend taking pictures with the viewfinder when panning in [MODE3].

[REC] Mode:

Compensating the Exposure

Use this function when you cannot achieve appropriate exposure due to the difference in brightness between the subject and the background. Look at the following examples.

Underexposed



Properly exposed



Overexposed



Compensate the exposure towards positive.

Compensate the exposure towards negative.

1 Press the rear dial to switch to Exposure Compensation operation.

2 Rotate the rear dial to compensate the exposure.

- (A) Exposure Compensation value
- (B) [EXPO.METER]

- The Exposure Compensation value can be set within a range of -5 EV to $+5$ EV. When recording motion pictures, the Exposure Compensation value can be set within a range of -3 EV to $+3$ EV.
- Select [0] to return to the original exposure.
- Rotate the rear dial to display the [EXPO.METER]. (P133) (However, it does not appear in



Note

- When the exposure value is out of the -3 EV to $+3$ EV range, the brightness of the recording screen will no longer change. It is recommended to record by checking the actual brightness of the recorded image in the Auto Review or playback screen.
- The set exposure value is memorised even if the camera is turned off. However, the exposure value during the Intelligent Auto Mode is not memorised.
- The compensation range of the exposure will be limited depending on the brightness of the subject.
- When the aperture and shutter speed values are displayed in the screen in the Programme AE Mode, Programme Shift operation and Exposure Compensation operation is switched every time the rear dial is pressed.
- In the Aperture-Priority AE Mode, Aperture Setting operation (P93) and Exposure Compensation operation is switched every time the rear dial is pressed.
- In the Shutter-Priority AE Mode, Shutter Speed Setting operation (P93) and Exposure Compensation operation is switched every time the rear dial is pressed.
- Operation method can be changed with [EXPO. SETTINGS] in the [CUSTOM] menu. (P133)
- Exposure compensation can be performed by touching the exposure compensation display, and then using the slide bar in the Quick Menu (P56) while in touch operation.
- In the Quick Menu (P57) while in button operation, if set to (LCD monitor style), exposure compensation can be set with $\blacktriangle/\blacktriangledown$ after selecting to display exposure compensation with $\blacktriangleleft/\blacktriangleright$ or the rear dial.

- In the Quick Menu (P57) while in button operation, if set to [] (viewfinder style), after selecting the Exposure Compensation display using the rear dial or ◀/▶, pressing the rear dial or [MENU/SET] will allow you to compensate the exposure with the rear dial or ◀/▶.

[REC] Mode: [A] [P] [AS] [M] [C1] [C2] [C3] [SCN] [] [] [] []

Taking Pictures using Burst Mode

Pictures are taken continuously while the shutter button is pressed.

Select the ones you really like from among the pictures you have taken.

Pictures taken with a burst speed of [SH] will be recorded as a single burst group (P137).

1 Set the drive mode lever to [].

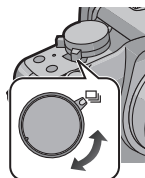

2 Focus on the subject and take a picture.

- Ⓐ When Burst Mode is set to high speed [H].
- Hold down the shutter button fully to activate the Burst Mode.

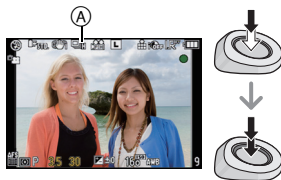

■ Changing the burst speed

- 1 Select [BURST RATE] in the [REC] Mode menu. (P55)
- 2 Press ▲/▼ to select the burst speed and then press [MENU/SET].

		[SH] (Super high speed)	[H] (High speed)	[M] (Middle speed)	[L] (Low speed)
Burst speed (pictures/second)		40	5* ²	3	2
Live View during Burst Mode		None	None	Available	Available
1	With RAW files	—	4 to 7 ³		
	Without RAW files	Max. 40	Depends on the remaining capacity of the card* ³		

*1 Number of recordable pictures

*2 When quality is set to [RAW], [RAW+], [RAW+], [RAW], burst speed is 4.5 pictures/second.

*3 Pictures can be taken until the capacity of the card becomes full. However the burst speed will become slower halfway. The exact timing of this depends on the aspect ratio, the picture size, the setting for the quality and the type of card used.

- First burst speed has no relation with the transfer speed of the card.
- The burst speed values given above apply when the shutter speed is 1/60 or faster and when the flash is not activated.
- The Burst Mode speed may become slower depending on the following settings.
 - [SENSITIVITY] (P91)/[PICTURE SIZE] (P120)/[QUALITY] (P121)/[FOCUS PRIORITY] (P131)/Focus Mode
- **The picture size will be fixed to [S] when [SH] is set.**
- Refer to P121 for information about RAW files.

■ Focusing in Burst Mode

The focus changes depending on the setting for [FOCUS PRIORITY] (P131) in the [CUSTOM] menu and the Focus Mode setting.

Focus Mode	Focus Priority	Focus
AFS	ON	At the first picture
	OFF	
AFC*1	ON	Normal focusing*2
	OFF	Predicted focusing*3
MF	—	Focus set with Manual Focus

*1 When the subject is dark or the burst speed is set to [SH], the focus is fixed on the first picture.

*2 The burst speed may become slower because the camera is continuously focusing on the subject.

*3 Burst speed takes priority, and focus is estimated within possible range.

Note

- We recommend using the remote shutter (DMW-RSL1; optional) when you want to keep the shutter button pressed fully while taking pictures in Burst Mode. Refer to P172 for information about the remote shutter.
- When the burst speed is set to [SH] or [H] (when the Focus Mode is [AFS] or [MF]), the exposure and White Balance are fixed at the settings used for the first picture for the subsequent pictures as well. Depending on the brightness of the subject, the second picture and subsequent pictures may be brighter or darker. When the burst speed is set to [H] (when the Focus Mode is [AFC]), [M] or [L], they are adjusted each time you take a picture.
- If you are following a moving subject while taking pictures in a place indoors, outdoors etc. where there is a large difference between the light and shade (landscape), it may take time until the exposure is stable. If burst is used at this time, the exposure may not become optimal.
- Since the shutter speed becomes slower in dark places, the burst speed (pictures/second) may become slower.
- When set to [SH] or [H], the Auto Review function is activated regardless of the Auto Review setting. (Will not hold) You cannot set the Auto Review function in the [SETUP] menu.
- When set to [M] or [L], Live View is displayed between burst frames.
- When the flash is activated, you can take only 1 picture.
- **Maximum of 3 films will be recorded depending on the Multi Film Bracket setting during the Multi Film Bracket recording (P119).**
It will automatically switch to [H] when set to [SH].
- The Burst Mode is disabled when White Balance Bracket or Aspect Bracket is set.
- The Burst Mode is disabled during recording of the motion pictures.
- The following functions cannot be used when the burst speed is set to [SH].
 - [EX. TELE CONV.]/[DIGITAL ZOOM]/[LONG SHTR NR]/[MODE2] of [STABILIZER]/[RAW $\frac{1}{2}$], [RAW $\frac{1}{4}$] or [RAW] of [QUALITY]

[REC] Mode: **IA PASM C1 C2 C3 SCN**

Taking Pictures using Auto Bracket

Maximum of 7 pictures will be recorded with different exposure settings following the Exposure Compensation range every time the shutter button is pressed. You can select the picture with the desired exposure among different exposures.

With Auto Bracket

[STEP]: [3·1/3], [SEQUENCE]: [0/-/+]

1st picture



±0 EV

2nd picture



-1/3 EV

3rd picture

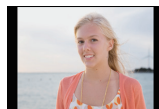

+1/3 EV

- 1 Set the drive mode lever to

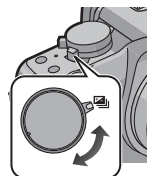

- 2 Focus on the subject and take a picture.

Ⓐ Auto Bracket indication (When burst is set.)

- If you press and hold the shutter button, the number of pictures that you set is taken.
- The Auto Bracket indication blinks until the number of pictures that you set is taken.
- The picture count is reset to [0] if you change the Auto Bracket setting, change the setting on the drive mode lever or turn the camera off before all the pictures that you set are taken.

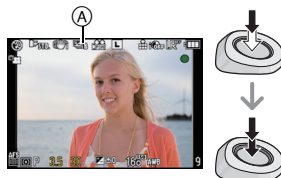

■ Changing the settings for [□/📷]SETTINGS, [STEP] and [SEQUENCE] in Auto Bracket

- 1 Select [AUTO BRACKET] in the [REC] Mode menu. (P55)
- 2 Press ▲/▼ to select [□/📷]SETTINGS, [STEP] or [SEQUENCE] and then press ▶.

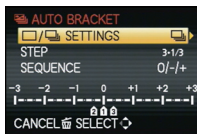

- 3 Press ▲/▼ to select the setting and then press [MENU/SET].

Item	Settings
[□/📷]SETTINGS	[□] (single)
	[📷] (burst)
[STEP]	[3•1/3] (3 pictures)
	[3•2/3] (3 pictures)
	[3•1] (3 pictures)
	[5•1/3] (5 pictures)
	[5•2/3] (5 pictures)
	[5•1] (5 pictures)
	[7•1/3] (7 pictures)
	[7•2/3] (7 pictures)
	[7•1] (7 pictures)

Item	Settings
[SEQUENCE]	[0/-/+]
	[-/0/+]

- You can take one picture at a time when set to [□].
- You can continuously take pictures up to set numbers when set to [📷].

- 4 Press [MENU/SET] twice to close the menu.

Note

- When taking pictures using Auto Bracket after setting the Exposure Compensation range, the pictures taken are based on the selected Exposure Compensation range.
- The exposure may not be compensated with Auto Bracket depending on the brightness of the subject.
- The Auto Review function is activated regardless of the Auto Review setting. (Will not hold) You cannot set the Auto Review function in the [SETUP] menu.
- When the flash is activated, you can take only 1 picture.
- Auto Bracket is disabled when Multi Film Bracket, White Balance Bracket, or Aspect Bracket is set.
- The Auto Bracket will be disabled during recording of the motion pictures.

[REC] Mode: **IA P AS M C1 C2 C3 SCN**    

Taking Pictures with the Self-timer

1 Set the drive mode lever to .

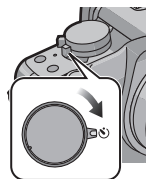

2 Press the shutter button halfway to focus and then press it fully to take the picture.



A When self-timer is set to .

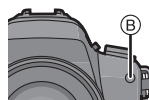

- A picture is not taken until the subject is brought into focus. Focus and exposure will be set when the shutter button is pressed halfway.
- If you want to press the shutter button fully to take a picture even when the subject is not focused, set [FOCUS PRIORITY] in the [CUSTOM] menu to [OFF]. (P131)
- The self-timer indicator **B** blinks and the shutter is activated after 10 seconds (or 2 seconds).
- If you press [MENU/SET] while taking a picture with the self-timer, it is cancelled.
- When  is selected, the self-timer indicator blinks again after the first and the second pictures are taken and the shutter is activated 2 seconds after it blinks.





■ Changing the time setting for the self-timer

1 Select [SELF-TIMER] in the [REC] Mode menu. (P55)

2 Press / to select the mode and then press [MENU/SET].

Item	Settings
	10 seconds
	After 10 seconds the camera takes 3 pictures at about 2 second intervals.
	2 seconds

Note

- When using a tripod etc., setting the self-timer to 2 seconds is a convenient way to avoid the jitter caused by pressing the shutter button.
- We recommend using a tripod when recording with the self-timer.
- Depending on the recording conditions, the recording interval may become more than 2 seconds when  is selected.
- The flash output may not be constant when  is set.
- Up to 3 films are recorded automatically, depending on the Multi Film Bracket setting, when the shutter button is pressed once during the recording with Multi Film Bracket.
- Use the Quick Menu (P56) to set when in Intelligent Auto Mode.
- It cannot be set to  in Intelligent Auto Mode or when White Balance Bracket or Aspect Bracket is set.
- The self-timer will be disabled during recording of the motion pictures.

[REC] Mode: **P A S M**         

Setting the Method used to Focus (AF Mode)

This allows the focusing method that suits the positions and number of the subjects to be selected.



Also, it is possible to set the focus and exposure to the subject specified on the touch panel. Select the mode that matches the recording conditions and the composition.

1 Set the focus mode lever to [AFS] or [AFC].

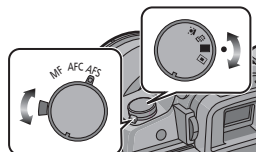
2 Switching the auto focus mode dial.



Note

- It is not possible to set [ - In [FOOD] in [CLOSE-UP]
 - In [NIGHT SCENERY] in Scene Mode
- The AF Mode is fixed to [- AF area will be fixed to a small point in [PERIPHERAL DEFOCUS] in Scene Mode.
- It will be set to [

About [

The camera automatically detects the person's face. The focus and exposure can then be adjusted to fit that face no matter what portion of the picture it is in. (max. 15 areas)

When the camera detects a person's face, the AF area is displayed.

Yellow:



When the shutter button is pressed halfway, the frame turns green when the camera is focused.

White:

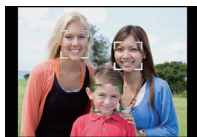
Displayed when more than one face is detected. Other faces that are the same distance away as faces within the yellow AF areas are also focused.



Note

- Position and size of the AF area can be changed. (P84)**
 - When [ - Under certain picture-taking conditions including the following cases, the facial recognition function may fail to work, making it impossible to detect faces. The AF Mode is switched to [ - When the face is not facing the camera
 - When the face is at an angle
 - When the face is extremely bright or dark
 - When there is little contrast on the faces
 - When the facial features are hidden behind sunglasses, etc.
 - When the face appears small on the screen
 - When there is rapid movement
 - When the subject is other than a human being
 - When the camera is shaking
- The camera may detect the subjects other than a person as the face. In this case, switch the AF Mode to any modes other than [

Setting up [AF-ON] (AF Tracking)

Focus and exposure can be adjusted to a specified subject. Focus and exposure will keep on following the subject even if it moves. (Dynamic tracking)

■ When operating the touch panel

You can lock the subject by touching it.

- The AF area turns yellow while the subject is locked.
- Lock is cancelled when [CANCEL] is touched.



■ When operating buttons

Place the subject in the AF tracking frame, and press the shutter button halfway to lock the subject.

Ⓐ AF tracking frame

- AF area will turn green when the camera detects the subject.
- The AF area turns yellow when the shutter button is released.
- Lock is cancelled when [MENU/SET] is pressed.



Ⓐ

Note

- If it fails to lock, AF area will flash in red, and disappear. Try to lock again.
- AF Tracking will not operate when it has failed to AF track. AF Mode will be switched to [AF-ON] in that case.
- In the following cases, [AF-ON] operates as [AF-ON]
 - When the Film Mode is [STANDARD] ([B&W]), [DYNAMIC] ([B&W]), [SMOOTH] ([B&W])
 - When My Colour Mode is [MONOCHROME]
 - When recording motion pictures
- Dynamic tracking function may not work in the following cases:
 - When the subject is too small
 - When the recording location is too dark or bright
 - When the subject is moving too fast
 - When the background has the same or similar colour to the subject
 - When jitter is occurring
 - When zoom is operated

About [23-AREA] (23-area-focusing)

Up to 23 points for each AF area can be focused. This is effective when the subject is not in the centre of the screen.

(AF area frame will be same as image aspect ratio setting)

Note

- **The 23 AF areas can be divided into 9 areas and the area to be focused can be set. (P84)**
- AF area is not displayed until it is in focus. Also, when the Focus Mode is set to [AFC], the AF area is not displayed even if it is in focus.
- The camera is focusing on all the AF areas using [23-AREA] when multiple AF areas (max. 23 areas) light at the same time. If you want to determine the focus position to take pictures, switch the AF Mode to [AF-ON].

About [AF] (1-area-focusing)

The camera focuses on the subject in the AF area on the screen.

Note

- **Position and size of the AF area can be changed. (P84)**
- When the subject is not in the centre of the composition in [AF], you can bring the subject into the AF area, fix the focus and exposure by pressing the shutter button halfway, move the camera to the composition you want with the shutter button pressed halfway, and then take the picture. (Only when the focus mode lever is set to [AFS])

Setting up position of the AF area/changing size of the AF area

When selecting [AF], [AF]

Position and size of the AF area can be changed.

1 Touch the subject.

- AF area setting screen is displayed.
- It is also possible to move the AF area using the cursor button after pressing and holding the [Q.MENU] button until the AF area setting screen is displayed.
- The AF area returns to the centre when [AF] is pressed.

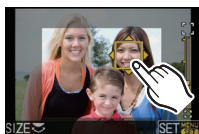

2 Touch the slide bar to change the size of AF area frame.

- It can be changed to 4 different sizes.
- It is also possible to rotate the rear dial to the right to make it larger. Rotate it to the left to make it smaller.



3 Touch [SET].

- AF area with the same function as [AF] is displayed in the touched position, when the [AF] is selected. Setting of the AF area is cleared when [CANCEL] is touched.

When selecting [AF]

The 23 AF areas can be divided into 9 areas and the area to be focused can be set.

Touch the screen to display the AF area setting screen, and select the AF area frame as shown in the figure on the right.

- After releasing your finger from the touch panel for a while, AF area frame will disappear, and only [+] display (centre point of selected AF area frame) will remain on the screen.
- Press and hold the [Q.MENU] button until the AF area setting screen is displayed. The AF area frame can then also be selected by pressing the cursor button or by rotating the rear dial.
- Setting of the AF area frame is cancelled when [CANCEL] is touched.

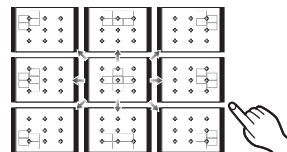

Move the AF area easily with button operations

When the [DIRECT FOCUS AREA] in the [CUSTOM] menu is set to [ON] while [AF], [AF] or [AF] is selected, it is possible to move the AF area directly with the cursor button.

- Use the Quick Menu (P56) to set the functions assigned to the cursor button, such as [SENSITIVITY] (P91), [WHITE BALANCE] (P88), etc.

Note

- The spot metering target can also be moved to match the AF area when using [AF]. (P122)
- Change the size of the AF area when there is trouble focusing with a small AF area.
- [DIRECT FOCUS AREA] is fixed to [OFF] in My Colour Mode.

[REC] Mode: **PA** **SM** **C1** **C2** **C3** **SCN**    

Taking Pictures with Manual Focus

Use this function when you want to fix the focus or when the distance between the lens and the subject is determined and you do not want to activate Auto Focus.

1 Set the focus mode lever to [MF].

2 Rotate the focus ring to focus on the subject.

- When the [MF ASSIST] in the [CUSTOM] menu is set to [ON], screen will be enlarged about 5 times as MF Assist. (A)
- MF guide (B) is displayed on the screen when the focus ring is rotated if the [MF GUIDE] in the [CUSTOM] menu is set to [ON]. You can check the direction of rotation of the focus ring is toward the near side or the far side.

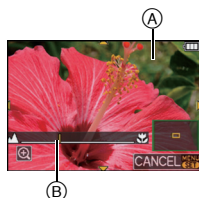

MF ASSIST



■ Displaying the MF Assist

- It is displayed by rotating the focus ring or touching the screen.
- It can also be displayed by pressing and holding the [Q.MENU] button to display the setup screen for the enlarged area, deciding the area to enlarge using the cursor button, and then pressing [MENU/SET].
- It will switch to the setting screen for the enlarged area by pressing the cursor button when the [DIRECT FOCUS AREA] in the [CUSTOM] menu is set to [ON].

■ Moving the enlarged area

- The enlarged area can be moved by dragging the screen (P16), or pressing the cursor button.
- The following will return the MF assistance to the original position.
 - When the Focus Mode is set to other than [MF]
 - Changing [ASPECT RATIO] or [PICTURE SIZE]
 - Turning the camera off

■ Changing the magnification

- It is enlarged to 10 times by touching . It will return to 5 times by touching .
- MF Assist is enlarged from 5 times to 10 times when the rear dial is rotated right. It will return to 5 times by rotating the rear dial left.

■ Closing the MF Assist

- It will close when the shutter button is pressed halfway.
- It will also close by touching the [CANCEL] on the screen or pressing [MENU/SET].
- When displayed by rotating the focus ring, it is closed approximately 10 seconds after the operation is stopped.

Note

- The MF Assist does not appear when using the Digital Zoom or recording motion pictures.
- MF Assist or MF guide may not display depending on the lens used, but you can display MF Assist by direct operation of the camera, using the touch panel or a button.

Technique for Manual Focus

- 1 Rotate the focus ring to focus on the subject.
- 2 Rotate it a little more.
- 3 Finely focus on the subject by rotating the focus ring slowly in reverse.



Note

- If you use the zoom function after focusing on the subject, focus on the subject again.
- After cancelling Sleep Mode, focus on the subject again.
- If you are taking close-up pictures
 - We recommend using a tripod and the self-timer (P81).
 - The effective focus range (depth of field) is significantly narrowed. Therefore, if the distance between the camera and the subject is changed after focusing on the subject, it may become difficult to focus on it again.
 - The resolution of the periphery of the picture may decrease slightly. This is not a malfunction.

About the focus distance reference mark

The focus distance reference mark is a mark used to measure the focus distance.

Use this when taking pictures with Manual Focus or taking close-up pictures.

- (A) Focus distance reference mark
- (B) Focus distance reference line
- (C) 0.5 m (1.64 feet) (When the 14–140 mm/ F4.0–5.8 lens supplied in DMC-GH2H is used)
- (D) 0.3 m (0.99 feet) (When the 14–42 mm/ F3.5–5.6 lens supplied in DMC-GH2K is used)

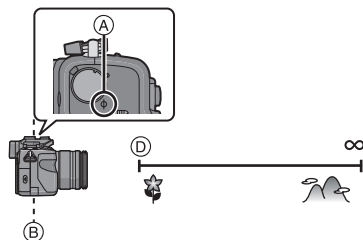
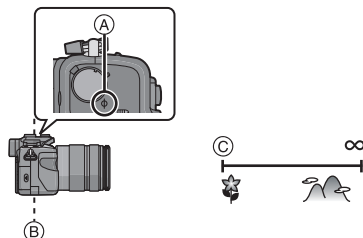

[REC] Mode: PASMCM23 [M] SCN [A] [B] [C] [D]

Fixing the Focus and the Exposure (AF/AE Lock)

This is useful when you want to take a picture of a subject outside the AF area or the contrast is too strong and you cannot achieve appropriate exposure.

- 1 Align the screen with the subject.
- 2 Press and hold [AF/AE LOCK] to fix the focus or exposure.

(A) [AF/AE LOCK] button

- If you release [AF/AE LOCK], AF/AE Lock is cancelled.

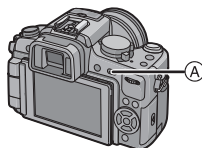

- 3 While pressing [AF/AE LOCK], move the camera as you compose the picture and then press shutter button fully.

(B) AE lock indication

- When [AE] is set, after pressing the shutter button halfway to focus, press the shutter button fully.



■ AF/AE Lock

Locking of the focus and exposure can be set in [AF/AE LOCK] in the [CUSTOM] menu.

[AE]:

- Only the exposure is locked.
- [AEL], aperture value, the shutter speed light when the exposure is set.

[AF]:

- Only the focus is locked.
- [AFL], the focus indication, aperture value, the shutter speed light when the subject is focused.

[AF/AE]:

- Both focus and exposure are locked.
- [AFL], [AEL], the focus indication, aperture value and the shutter speed light when the subject is focused and the exposure is set.

Note

- If you set [AF/AE LOCK HOLD] in the [CUSTOM] menu to [ON], you can fix the focus and the exposure even if you release [AF/AE LOCK] after pressing it. (P131)
- The brightness of the image displayed on the LCD monitor/viewfinder (Live View) will be also locked when the AE lock is performed.
- AF Lock only is effective when taking pictures in Manual Exposure Mode.
- AE Lock only is effective when taking pictures with Manual Focus.
- AE/AF lock cannot be performed again during motion picture recording. During motion picture recording only cancellation of AE/AF lock can be performed.
- The exposure is set, even if the brightness of the subject changes.
- The subject can be focused again by pressing the shutter button halfway even when AE is locked.
- Programme Shift can be set even when AE is locked.

[REC] Mode: **P A S M**      

Adjusting the White Balance

In sunlight, under incandescent lights or in other such conditions where the colour of white takes on a reddish or bluish tinge, this item adjusts to the colour of white which is closest to what is seen by the eye in accordance with the light source.

1 Press **▶** (WB).



2 Touch the White Balance to select.



3 Touch **[SET]**.



Item	Recording conditions
[AWB]	Automatic adjustment
[☀]	When taking pictures outdoors under a clear sky
[☁]	When taking pictures outdoors under a cloudy sky
[🏠]	When taking pictures outdoors in the shade
[💡]	When taking pictures under incandescent lights
[📷]*	When taking pictures with the flash only
[📷]/[📷]/[📷]/[📷]	When using the preset White Balance
[📷]	When using the preset colour temperature setting

*It will operate as [AWB] during motion picture recording.

■ Auto White Balance



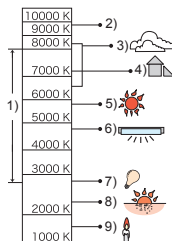

Depending on the conditions prevailing when pictures are taken, the pictures may take on a reddish or bluish tinge. Furthermore, when a multiple number of light sources are being used or there is nothing with a colour close to white, Auto White Balance may not function properly. In a case like this, set the White Balance to a mode other than [AWB].

- Auto White Balance will work within this range.
- Blue sky
- Cloudy sky (Rain)
- Shade
- Sunlight
- White fluorescent light
- Incandescent light bulb
- Sunrise and sunset
- Candlelight

K=Kelvin Colour Temperature









Note

- The optimal White Balance will differ depending on the type of fluorescent lighting being recorded under so use [AWB], [, [, [, or [].
- When the flash is used, if you take a picture beyond the available flash range, the White Balance may not be properly adjusted.
- The White Balance is memorised even if the camera is turned off, but [WHITE BALANCE] for the Advanced Scene Mode or the Scene Mode is set to [AWB] when the Advanced Scene Mode or the Scene Mode is changed.
- White Balance is fixed to [AWB] in following conditions.
 - In Intelligent Auto Mode
 - In [OUTDOOR PORTRAIT] and [INDOOR PORTRAIT] in [PORTRAIT]
 - In [SCENERY]
 - In [FOOD] in [CLOSE-UP]
 - In [NIGHT PORTRAIT], [NIGHT SCENERY], [SUNSET] or [PARTY] in Scene Mode
 - My Colour Mode
- When [DIRECT FOCUS AREA] (P84) is set to [ON], the operations on the cursor buttons translate to movements of the AF area. Set using the Quick Menu (P56).

■ Setting the White Balance manually

Set the White Balance value. Use to match the condition when taking photographs.

- 1 Select the white set icon (such as [, and then touch [SELECT WHITE SET].**
 - The white set selecting screen can also be displayed by pressing the cursor button toward .
- 2 Select [, [, [, or [ and then touch [WHITE SET].**
 - The White Balance setting screen can also be displayed by pressing the cursor button toward .
- 3 Aim the camera at a sheet of white paper etc. so that the frame in the centre is filled by the white object only and then touch [SET].**

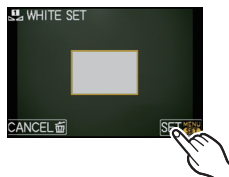







Note

- White Balance may not be set when the subject is too bright or too dark. Set the White Balance again after adjusting to appropriate brightness.

■ Setting the colour temperature

You can set the colour temperature manually for taking natural pictures in different lighting conditions. The colour of light is measured as a number in degrees Kelvin. As the colour temperature increases, the picture becomes more bluish. As the colour temperature decreases, the picture becomes more reddish.

- 1 Select [] and then touch [WB K SET].**
 - The colour temperature setting screen can also be displayed by pressing the cursor button toward .
- 2 Touch the colour temperature setting bar.**
 - It is also possible to set the values by touching []/[] or pressing /  of the cursor button.
 - You can set a colour temperature from [2500K] to [10000K].
- 3 Touch [SET].**



■ Finely adjusting the White Balance

You can finely adjust the White Balance when you cannot acquire the desired hue by setting the White Balance.

1 Select the White Balance and then touch [ADJUST].

- The White Balance adjust screen can also be displayed by pressing the cursor button toward ▼.

2 Touch within the frame to finely adjust.

- You can finely adjust also by touching [G+]/[M-]/[A]/[B], or pressing ▲/▼/◀/▶ of the cursor button.

- ◀ : A (AMBER: ORANGE)
- ▶ : B (BLUE: BLUISH)
- ▲ : G+ (GREEN: GREENISH)
- ▼ : M- (MAGENTA: REDDISH)



3 Touch [SET].

Note

- If you finely adjust the White Balance to A (amber), the White Balance icon on the screen will change to orange. If you finely adjust the White Balance to B (blue), the White Balance icon on the screen will change to blue.
- If you finely adjust the White Balance to G+ (green) or M- (magenta), [+] (green) or [-] (magenta) appears beside the White Balance icon on the screen.
- Press [DISPLAY] to return to the centre point.
- Select the centre point if you are not finely adjusting the White Balance.
- The White Balance fine adjustment setting is reflected in the picture when using the flash.
- You can finely adjust the White Balance independently for each White Balance item.
- The White Balance fine adjustment setting is memorised even if the camera is turned off.
- The White Balance fine adjustment level returns to the standard setting (centre point) in the following cases.
 - When you reset the White Balance in [,], [,], [,] or [,]
 - When you reset the colour temperature manually in [K]

■ White Balance Bracket

Bracket setting is performed based on the adjustment values for the White Balance fine adjustment, and 3 pictures with different colours are automatically recorded when the shutter button is pressed once.

1 Finely adjust the White Balance in step 2 of the “Finely adjusting the White Balance” procedure, and touch []/ [] to set the bracket.

- Bracket settings can also be made by rotating the rear dial.

[] or rear dial right: Horizontal (A to B)

[] or rear dial left: Vertical (G+ to M-)



2 Touch [SET].

Note

- [BKT] is displayed in White Balance icon in the screen when the White Balance Bracket is set.
- The White Balance Bracket setting is released when the power has been turned off (including Sleep Mode).
- You will only hear the shutter sound once.
- [RAW], [RAW] or [RAW] for [QUALITY] cannot be set.
- White Balance Bracket does not work when recording motion pictures.

[REC] Mode: **PASMC123**

Setting the Light Sensitivity

This allows the sensitivity to light (ISO sensitivity) to be set. Setting to a higher figure enables pictures to be taken even in dark places without the resulting pictures coming out dark.

1 Press ▲ (ISO).



2 Touch the ISO sensitivity to select.

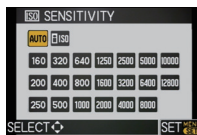

3 Touch [SET].



ISO sensitivity	160	12800
Recording location (recommended)	When it is light (outdoors)	When it is dark
Shutter speed	Slow	Fast
Noise	Less	Increased

ISO sensitivity	Settings
AUTO*	The ISO sensitivity is automatically adjusted according to the brightness.
iISO* (Intelligent)	The ISO sensitivity is adjusted according to the movement of the subject and the brightness.
160/200/250/320/400/500/640/800/1000/1250/1600/2000/2500/3200/4000/5000/6400/8000/10000/12800	The ISO sensitivity is fixed to various settings.

* When the [ISO LIMIT SET] of [REC] Mode menu (P124) is set to anything except [OFF], it is set automatically within the value set in [ISO LIMIT SET].

It is set as following when the [ISO LIMIT SET] is set to [OFF].

[When the 3D interchangeable lens (optional) is attached, it may become higher than the following settings.]

- When [AUTO] is selected, ISO sensitivity is adjusted automatically depending on brightness within a maximum setting of [ISO400].
- When setting to [iISO], ISO sensitivity will adjust automatically depending on brightness within the maximum setting of [ISO800]. ([ISO400] when the flash is used)
- The ISO sensitivity will be set to [AUTO] (for motion pictures) when recording motion pictures. Also, the [ISO LIMIT SET] will not operate.
- Setting items below will be selectable in Creative Motion Picture Mode. [AUTO]/[160] to [3200]

■ About [ISO] (Intelligent ISO sensitivity control)

The camera automatically sets the optimum ISO sensitivity and shutter speed to suit the movement of the subject and brightness of the scene to minimise the jitter of the subject.

- The shutter speed is not fixed when the shutter button is pressed halfway. It is continuously changing to match the movement of the subject until the shutter button is pressed fully. Confirm the actual shutter speed on the information display for the picture being played back.



Note

- The higher the value set for the ISO sensitivity, the more the jitter is reduced but the greater the amount of picture noise.
- Refer to P72 for the flash range.
- Depending on the brightness and how fast the subject is moving, jitter may not be avoided even if [ISO] is selected.
- Movements may not be detected when a moving subject is small, when a moving subject is at the edge of the screen or when a subject has moved at the very moment when the shutter button was pressed fully.
- The setting is fixed to [ISO] in the following cases.
 - In [SPORTS], [BABY1]/[BABY2] and [PET] in Scene Mode
 - In [INDOOR PORTRAIT] in Advanced Scene Mode
- Programme Shift cannot be activated when the ISO sensitivity is set to [ISO].
- You cannot select [ISO] in Shutter-Priority AE Mode and Manual Exposure Mode. Also, you cannot select [AUTO] in Manual Exposure Mode.
- To avoid picture noise, we recommend reducing the ISO sensitivity, setting [NOISE REDUCTION] in [FILM MODE] towards [+] or setting the items except [NOISE REDUCTION] towards [-] to take pictures. (P118)
- When [DIRECT FOCUS AREA] (P84) is set to [ON], the operations on the cursor buttons translate to movements of the AF area. Set using the Quick Menu (P56).

[REC] Mode: **[A]**S

Taking Pictures by Specifying the Aperture/ Shutter Speed

[A] Aperture-priority AE

Set the aperture value to a higher number when you want a sharp focus background. Set the aperture value to a lower number when you want a soft focus background.

1 Set the mode dial to **[A]**.

2 Rotate the rear dial to set the aperture value.

- It will switch between aperture setting operation and Exposure Compensation operation every time the rear dial is pressed.
- Rotate the rear dial to display the [EXPO.METER]. (P133)



[S] Shutter-priority AE

When you want to take a sharp picture of a fast moving subject, set with a faster shutter speed. When you want to create a trail effect, set to a slower shutter speed.

1 Set the mode dial to **[S]**.

2 Rotate the rear dial to set the shutter speed.

- It will switch between shutter speed setting operation and Exposure Compensation operation every time the rear dial is pressed.
- Rotate the rear dial to display the [EXPO.METER]. (P133)



Note

- **It will be a normal motion picture recording when recording a motion picture.**
- How the Exposure Compensation is switched can be changed by [EXPO. SETTINGS] (P133) in the [CUSTOM] menu.
- In the Quick Menu (P56) while in touch operation, setting of the aperture value or shutter speed can be set by touching the aperture value or shutter speed, and then touching the exposure meter bar.
- The brightness of the LCD monitor/Viewfinder and the recorded pictures may differ. Check the pictures on the playback screen.
- Set the aperture value to a higher number when the subject is too bright in Aperture-Priority AE Mode. Set the aperture value to a lower number when the subject is too dim.
- When you use a lens with an aperture ring, the setting for the rear dial becomes effective if you rotate the aperture ring to the [A] position and the aperture ring setting takes priority if you rotate the aperture ring to a position other than [A] in Aperture-Priority AE Mode.

- The aperture value and the shutter speed displayed on the screen turn red and blink when the exposure is not adequate.
- We recommend using a tripod when the shutter speed is slow.
- When the flash is activated, the shutter speed cannot be set to faster than 1/160th of a second in Shutter-Priority AE Mode. (P73)
- If you press the shutter button fully when the shutter speed is slow, the shutter speed on the screen counts down in Shutter-Priority AE Mode.
- [1/5] and [1/30] cannot be set for Shutter-Priority AE Mode.
- The [SENSITIVITY] is automatically set to [AUTO] when you switch the Recording Mode to Shutter-Priority AE Mode while the [SENSITIVITY] is set to [ISO] (Intelligent).

[REC] Mode: **M**

Taking Picture by Setting the Exposure Manually

Determine the exposure by manually setting the aperture value and the shutter speed. The Manual Exposure Assistance appears on the lower portion of the screen to indicate the exposure.

1 Set the mode dial to **[M]**.

2 Rotate the rear dial to set the aperture and shutter speed.

- It will switch between aperture setting operation and shutter speed setting operation every time the rear dial is pressed.
- Rotate the rear dial to display the [EXPO.METER]. (P133)
- You can also set the focus manually by setting the focus mode lever to [MF]. (P85)



3 Press the shutter button halfway.

A Manual Exposure Assistance

- Set the aperture value and the shutter speed again when the exposure is not adequate.



Manual Exposure Assistance

	The exposure is adequate.
	Set to faster shutter speed or larger aperture value.
	Set to slower shutter speed or smaller aperture value.

- The manual exposure assistance is an approximation. We recommend checking the pictures on the playback screen.

■ About [B] (Bulb)

If you set the shutter speed to [B], the shutter stays open while the shutter button is pressed fully (up to about 120 seconds).

The shutter closes if you release the shutter button.

Use this when you want to keep the shutter open for a long time to take pictures of fireworks, a night scene etc.

- We recommend using a tripod or the remote shutter (DMW-RSL1; optional) when you take pictures with the shutter speed set to [B]. Refer to P172 for information about the remote shutter.
- If you set the shutter speed to [B], [B] is displayed on the screen.
- When you take pictures with the shutter speed set to [B], use a sufficiently charged battery. (P24)
- When you take pictures with the shutter speed set to [B], noise may become visible. To avoid picture noise, we recommend setting [LONG SHTR NR] in the [REC] Mode menu to [ON] before taking pictures. (P124)
- The manual exposure assistance does not appear.
- It can only be used with Manual Exposure Mode.

■ Constant preview

In Manual Exposure Mode, when [CONSTANT PREVIEW] in the [CUSTOM] menu is [ON], you will be able to confirm the effects of aperture and shutter speed on the screen. (P96)

- Close the flash.
- It can only be used with Manual Exposure Mode.



Note

- **It will be a normal motion picture recording when recording a motion picture.**
- It is possible to change the switching method of aperture and shutter speed settings with the [EXPO. SETTINGS] (P133) in the [CUSTOM] menu.
- In the Quick Menu (P56) while in touch operation, setting of the aperture value or shutter speed can be set by touching the aperture value or shutter speed, and then touching the exposure meter bar.
- The brightness of the LCD monitor/Viewfinder and the recorded pictures may differ. Check the pictures on the playback screen.
- If the exposure is not adequate, the aperture value and the shutter speed turn red and blink when the shutter button is pressed halfway.
- [⚡A], [⚡AⓄ], [⚡S] and [⚡SⓄ] for flash cannot be set.
- The [SENSITIVITY] is automatically set to [ISO160] when you switch the Recording Mode to Manual exposure while the [SENSITIVITY] is set to [AUTO] or [iISO] (Intelligent).
- If you press the shutter button fully when the shutter speed is slow, the shutter speed on the screen counts down.
- When you use a lens with an aperture ring, the aperture ring setting takes priority.

[REC] Mode:

Confirm the Effects of Aperture and Shutter Speed (Preview Mode)

Confirm the effects of aperture

You can check the depth of field (effective focus range) before taking a picture by closing the leaf shutter to the aperture value you set.

Press (A) (preview button).

- Preview screen is displayed. It will return to previous screen when is pressed.



■ Depth of field properties

*1	Aperture value	Small	Large
	Focus length of the lens	Tele	Wide
	Distance to the subject	Near	Distant
Depth of field (effective focus range)		Shallow (Narrow)*2	Deep (Wide)*3

*1 Recording conditions

*2 Example: When you want to take a picture with a blurred background etc.

*3 Example: When you want to take a picture with everything in focus including the background etc.

Confirm the effects of shutter speed

Movement can be confirmed by displaying the actual picture that will be taken with that shutter speed.

When the shutter speed is set for high speed, display in the shutter speed preview will be displayed like a time-release film. It is used in cases such as stopping the movement of running water.

Press [DISPLAY] while displaying the preview screen.

- Shutter speed preview screen is displayed. It will return to previous screen by pressing [DISPLAY] again.





DISPLAY



Note

- Operation method of can be changed with [PREVIEW HOLD] of [CUSTOM] menu (P133).
- It is possible to record while in Preview Mode.
- Range for shutter speed effect check is 8 seconds to 1/1000th of a second.

[REC] Mode:   

Taking Expressive Portraits and Landscape Pictures (Advanced Scene Mode)

You can take high-quality pictures of such subjects as people, scenery and flowers in accordance with the surrounding conditions.

1 Set the mode dial.

2 Press / to select the Advanced Scene Mode.



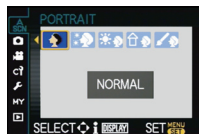

- Description of the selected mode is displayed when [DISPLAY] is pressed. (It will return to the previous screen when pressed again.)





3 Press [MENU/SET] to set.

- The menu screen is switched to the recording screen in the selected Advanced Scene Mode.

Note



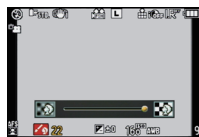

- To change the Advanced Scene Mode, press [MENU/SET], and return to above step 2 by pressing , while selecting the Advanced Scene Mode menu [s_{cn}] by pressing / / / .
- The Advanced Scene Mode flash setting is reset to the initial setting when the Advanced Scene Mode is changed and then used.
- When you take a picture with a Advanced Scene Mode that is not adequate for the purpose, the hue of the picture may differ from the actual scene.
- The following items cannot be set in Advanced Scene Mode because the camera automatically adjusts them to the optimal setting.
 - [SENSITIVITY]/Items other than [STANDARD] and [STANDARD] (**B&W**) in Film Mode/ [METERING MODE]/[FLASH SYNCHRO]/[I.RESOLUTION]/[I.DYNAMIC]/[ISO LIMIT SET]/ [DIGITAL ZOOM]

■ About the aperture value and the shutter speed when you select a creative setting

- You can change the aperture value and the shutter speed if you select a creative setting in Advanced Scene Mode. If you cannot get an adequate exposure when you rotate the rear dial, the aperture value and the shutter speed or the selection cursor will turn red.
- You can also press /  to set.
- It will switch between aperture setting or shutter speed setting operation and Exposure Compensation operation when the rear dial is pressed.



■ [PORTRAIT]

	[NORMAL PORTRAIT]		[INDOOR PORTRAIT]
	[SOFT SKIN]		[CREATIVE PORTRAIT]
	[OUTDOOR PORTRAIT]		

■ Technique for Portrait Mode

To make this mode more effective:

- Rotate the zoom ring as far as possible to Tele.
- Move close to the subject to make this mode more effective.



 **Note**

- In motion picture recording, [NORMAL PORTRAIT], [SOFT SKIN], [OUTDOOR PORTRAIT] and [INDOOR PORTRAIT] produce motion pictures using corresponding settings. [CREATIVE PORTRAIT] produces motion pictures using settings suitable for recording people.
- In [INDOOR PORTRAIT], the Intelligent ISO sensitivity control operates, and the maximum ISO sensitivity level becomes [ISO400].
- The initial setting for the AF Mode is [].
- When [SOFT SKIN] is selected, if a part of the background etc. is a colour close to skin colour, this part is also smoothed.
- When [SOFT SKIN] is selected, this mode may not be effective when there is insufficient brightness.

 **[SCENERY]**

	[NORMAL SCENERY]		[ARCHITECTURE]
	[NATURE]		[CREATIVE SCENERY]



 **Note**

- In motion picture recording, [NORMAL SCENERY], [NATURE] and [ARCHITECTURE] produce motion pictures using corresponding settings. [CREATIVE SCENERY] produces motion pictures using settings suitable for recording scenery.
- The flash setting is fixed to [].
- The initial setting for the AF Mode is [].

 **[CLOSE-UP]**

	[FLOWER]		[OBJECTS]
	[FOOD]		[CREATIVE CLOSE-UP]

 **Note**

- During motion picture recording, the motion picture will reflect the settings for each mode with [FLOWER], [FOOD] and [OBJECTS]. [CREATIVE CLOSE-UP] is suitable for near distance motion picture recording.
- We recommend using a tripod and the self-timer.
- We recommend setting the flash to [] (close the flash) when you take pictures at close range.
- Refer to "About the focus distance reference mark" on P86 for the focus range.
- When a subject is close to the camera, the effective focus range is significantly narrowed. Therefore, if the distance between the camera and the subject is changed after focusing on the subject, it may become difficult to focus on it again.
- Close-up Mode gives priority to a subject close to the camera, so it takes longer to focus on the further subjects.
- When you take pictures at close range, the resolution of the periphery of the picture may decrease slightly. This is not a malfunction.
- If the lens becomes dirty with fingerprints or dust, the lens may not be able to focus on the subject correctly.
- The initial setting for the AF Mode is [].

[REC] Mode: **SCN**

Taking Pictures that match the Scene being recorded (SCN: Scene Mode)

When you select a Scene Mode to match the subject and recording situation, the camera sets the optimal exposure and hue to obtain the desired picture.

1 Set the mode dial to **[SCN]**.

2 Press **▲/▼/◀/▶** to select the Scene Mode.

- Description of the selected mode is displayed when [DISPLAY] is pressed. (It will return to the previous screen when pressed again.)

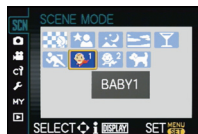

3 Press **[MENU/SET]** to set.

- The menu screen is switched to the recording screen in the selected Scene Mode.

Note

- To change the Scene Mode, press [MENU/SET], and return to above step **2** by pressing **▶**, while selecting the Scene Mode menu [SCN] by pressing **▲/▼/◀/▶**.
- The Scene Mode flash setting is reset to the initial setting when the Scene Mode is changed and then used.
- When you take a picture with a Scene Mode that is not adequate for the purpose, the hue of the picture may differ from the actual scene.
- The following items cannot be set in Scene Mode because the camera automatically adjusts them to the optimal setting.
 - [SENSITIVITY]/Items other than [STANDARD] and [STANDARD] (**B&W**) in Film Mode/[METERING MODE]/[FLASH SYNCHRO]*/[I.RESOLUTION]/[I.DYNAMIC]/[ISO LIMIT SET]/[DIGITAL ZOOM]
- * Can be set only when [PERIPHERAL DEFOCUS] is set.

[PERIPHERAL DEFOCUS]

This mode makes it easy to pick out the subject on which to focus and blurs the background to make the subject stand out.

■ Setting the AF area

1 Touch the subject to move the AF area.

- AF area can also be moved by pressing the cursor button.

2 Touch **[SET]**.

Note

- It will be a normal motion picture recording during the motion picture recording.
- Quick AF is performed automatically.
- Set the [WHITE BALANCE] (P88) using the Quick Menu (P56).
- AF area setting screen is displayed by pressing the cursor button. Press  to return the AF area to the centre of the screen.
- The obtained effects will differ depending on factors such as the distance to the subject and background, and the type of lens used. For best results, we recommend getting as close as possible to the subject when taking pictures. (P86)
- AF Mode will be fixed to a small point.

 [NIGHT PORTRAIT]

This allows you to take pictures of a person and the background with near real-life brightness.

■ Technique for Night Portrait Mode

- **Open the flash.** (You can set to [⚡☺].)
- We recommend using a tripod and the Self-timer for taking pictures.
- When [NIGHT PORTRAIT] is selected, keep the subject still for about 1 second after taking the picture.

Note

- **During motion picture recording, low light settings [📷] are used, which will provide better pictures in dimly lit rooms or at nightfall.**
- The shutter may remain closed after taking the picture. This is due to signal processing and is not a malfunction.
- Noise may become visible when you take pictures in dark places.
- The initial setting for the AF Mode is [👤].

 [NIGHT SCENERY]

This allows you to take vivid pictures of the nightscape.

■ Technique for Night Scenery Mode

- We recommend using a tripod and the Self-timer for taking pictures.

Note

- **During motion picture recording, low light settings [📷] are used, which will provide better pictures in dimly lit rooms or at nightfall.**
- **The flash setting is fixed to [☺].**
- The shutter may remain closed after taking the picture. This is due to signal processing and is not a malfunction.
- Noise may become visible when you take pictures in dark places.
- The initial setting for the AF Mode is [📷].

 [SUNSET]

Select this when you want to take pictures of a sunset view. This allows you to take vivid pictures of the red colour of the sun.



Note

- **The flash setting is fixed to [☺].**
- The initial setting for the AF Mode is [📷].

[PARTY]

Select this when you want to take pictures at a wedding reception, an indoor party etc. This allows you to take pictures of people and the background with near real-life brightness.

■ Technique for Party Mode

- **Open the flash.** (You can set to [] or [].)
- We recommend using a tripod and the self-timer for taking pictures.



Note

- The initial setting for the AF Mode is [].

[SPORTS]

Set here when you want to take pictures of sports scenes or other fast-moving events.



Note

- Intelligent ISO sensitivity control is activated, and maximum ISO sensitivity level becomes [ISO800].
- The initial setting for the AF Mode is [].

[BABY1]/ [BABY2]

This takes pictures of a baby with a healthy complexion. When you use the flash, the light from it is weaker than usual.

It is possible to set different birthdays and names for [BABY1] and [BABY2]. You can select to have these appear at the time of playback, or have them stamped on the recorded image using [TEXT STAMP] (P145).

■ Birthday/Name setting

- 1 Press **▲/▼** to select [AGE] or [NAME] and then press **▶**.
- 2 Press **▲/▼** to select [SET] and then press [MENU/SET].
- 3 Enter the birthday or name.

Birthday: **◀/▶**: Select the items (year/month/day).

▲/▼: Setting.

[MENU/SET]: Exit.

Name: For details on how to enter characters, refer to "Entering Text" on P117.

- When the birthday or name is set, [AGE] or [NAME] is automatically set to [ON].
- If [ON] is selected when the birthday or name has not been registered, the setting screen appears automatically.



- 4 Press [MENU/SET] to finish.

■ To cancel [AGE] and [NAME]

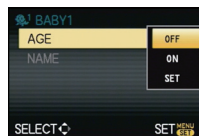
Select the [OFF] setting in step **2** of the "Birthday/Name setting" procedure.



 **Note**

- During motion picture recording, settings for [NORMAL PORTRAIT] are used. Also, still pictures recorded during motion picture recording ([) (Motion picture priorities) (P108) will not record age or name.
- The age and name can be printed out using the "PHOTOfunSTUDIO 6.0 BD Edition" bundled software on the CD-ROM (supplied).
- If [AGE] or [NAME] is set to [OFF] even when the birthday or name has been set, the age or name will not be displayed. Before taking pictures, set [AGE] or [NAME] to [ON].
- Intelligent ISO sensitivity control is activated, and maximum ISO sensitivity level becomes [ISO400].
- If the camera is turned on with [BABY1]/[BABY2] set, the age and name are displayed at the lower left of the screen for about 5 seconds, along with the current date and time.
- The initial setting for the AF Mode is [].

 [PET]

Select this when you want to take pictures of a pet such as a dog or a cat. You can set your pet's birthday and name.

For information about [AGE] or [NAME], refer to [BABY1]/[BABY2] on P101.

 **Note**



- It will be a normal motion picture recording during the motion picture recording.
- The initial setting for the AF Assist Lamp is [OFF].
- Intelligent ISO sensitivity control is activated, and maximum ISO sensitivity level becomes [ISO800].
- The initial setting for the AF Mode is [].
- Refer to [BABY1]/[BABY2] for other information about this mode.

[REC] Mode: 

Taking Pictures while Adjusting Colour

(: My Colour Mode)

You can take pictures with a desired effect by previewing the subject on the LCD monitor or viewfinder (Live View) and setting the desired effect.

- 1 Set the mode dial to [].
- 2 Touch []/[] to select an item.

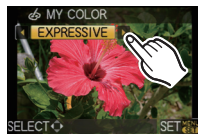

Item	Effect
[EXPRESSIVE]	This is a pop art style image effect that emphasises the colour.
[RETRO]	This is a soft image effect that gives the appearance of a tarnished photograph.
[PURE]	This is an image effect that uses a cool, bright light to give a feeling of freshness. (The image will come out bright and slightly bluish.)
[ELEGANT]	This is an image effect that creates a tranquil atmosphere and projects a feeling of stateliness. (The image will come out slightly dark and amberish.)
[MONOCHROME]	This is an image effect that captures the subject using tones characteristic of black and white photography, and with a whisper of colour.
[DYNAMIC ART]	This is an impressive image effect that adjusts dark areas and bright areas to appropriate brightness, together with enhancements on colours.
[SILHOUETTE]	This is an image effect that enhances the subject in the shade as a black silhouette by using the background colours of the sky or sunset etc.
[CUSTOM]	The colour effects can be set according to your preferences.

- 3 Touch [SET].

■ Readjust the My Colour settings

Return to above step 2 by pressing rear dial or cursor button.





Note

- During Motion Picture Recording, settings for My Colour Mode are used.
- My Colour settings are memorised even if the camera is turned off.
- Auto Bracket cannot be used in My Colour Mode.
- ISO sensitivity will be fixed to [AUTO].
- [I.DYNAMIC], [COLOR SPACE] can be set only when the My Colour Mode is set to [CUSTOM].
- The following items cannot be set in My Colour Mode because the camera automatically adjusts them to the optimal setting.
 - [FILM MODE]/[FLASH]/[FLASH SYNCHRO]/[ISO LIMIT SET]

■ Adjusting the custom settings to achieve desired effects

By selecting [CUSTOM], you can take pictures with colour, brightness and saturation adjusted to desired levels.

- 1 Touch [◀]/[▶] to select [CUSTOM].
- 2 Touch the item.

Item	Adjustment contents
 [COLOR]	This will adjust the colour of the image from red light to blue light. (11 steps in ± 5)
 [BRIGHTNESS]	This will adjust the brightness of the image. (11 steps in ± 5)
 [SATURATION]	This will adjust the colour intensity of the image from black and white to vivid colour. (11 steps in ± 5)
 [RESET]	Return all settings to default

- 3 Touch the slide bar.
- 4 Touch [SET].

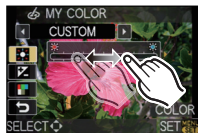

■ Return [CUSTOM] settings to default

- 1 Touch [] in above step 2.
- 2 Touch [YES].
 - Adjusted value for each item returns to standard (centre point).

Note

- Adjustments made with [CUSTOM] are not in effect in other Recording Modes.
- Icons for the adjusted items are displayed in the screen when the [CUSTOM] are adjusted. Displayed icon is the one for direction of adjustment.
- AF tracking may not function if you adjust [SATURATION] to make the colour lighter.

[REC] Mode: **C1** **C2** **C3**

Taking Pictures in Custom Mode

You can select one of your own custom settings saved with [CUST. SET MEM.] to suit the picture-taking conditions.

Initial setting of the Programme AE Mode is registered as the custom settings initially.

Set the mode dial to **[C1]**, **[C2]** or **[C3]**.

Ⓐ Display custom settings

• Saving of the selected custom settings is displayed on the screen.



Ⓐ

■ Registering Personal Menu Settings (Registering custom settings)

It is possible to register up to 3 sets of current camera settings as custom sets.

• Set to the mode dial to the desired mode and select the desired menu settings in advance.

1 Select [CUST. SET MEM.] in the [CUSTOM] menu. (P55)

2 Press ▲/▼ to select the custom set to register and then press [MENU/SET].

Custom set	Recording location
C1	[C1] on the mode dial
C2	[C2] on the mode dial
C3	[C3] on the mode dial

3 Press ▲ to select [YES] and then press [MENU/SET].

• When [YES] is selected, the settings that were previously stored are overwritten.

■ When changing the menu settings

Even if the menu settings are changed temporarily with [C1], [C2] or [C3] selected, what has been registered will remain unchanged.

To change what has been registered, overwrite the registered data using [CUST. SET MEM.] on the [CUSTOM] menu.

Note

• You cannot save the following menu items because they affect other Recording Modes.

[REC] menu/Recording functions	[SETUP] menu	[CUSTOM] menu
<ul style="list-style-type: none"> • [BABY1]/[BABY2] or [PET] birthday and name settings in Scene Mode • Data registered with [FACE RECOG.] 	<ul style="list-style-type: none"> • [CLOCK SET] • [WORLD TIME] • [TRAVEL DATE] • [LCD MODE] • [FAVORITE FUNC.] • [MENU GUIDE] • [LANGUAGE] 	<ul style="list-style-type: none"> • [TOUCH GUIDE] • [TOUCH SCROLL]

[REC] Mode: 

Selecting the Mode and Recording Motion Pictures

: Creative Motion Picture Mode)

You can enjoy motion picture recording with easily changeable settings by selecting Motion Picture Mode.

1 Set the mode dial to .

2 Press /▶ to select the Motion Picture Mode.

- Description of the selected mode is displayed when [DISPLAY] is pressed. (It will return to the previous screen when pressed again.)

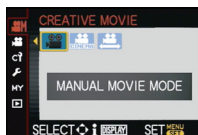

3 Press [MENU/SET] to set.

- The menu screen is switched to the recording screen in the Motion Picture Mode.

Note

- To change the Motion Picture Mode, press [MENU/SET], and return to above step 2 by pressing ▶, while selecting the Creative Motion Picture Mode menu  by pressing ▲/▼/◀/▶.
- You can also start/stop motion picture recording by pressing the shutter button. (You cannot take still pictures.)

[MANUAL MOVIE MODE]

It is possible to manually change the aperture and shutter speed and record motion pictures.

[24P CINEMA]

Record motion pictures with afterimages like a cinema.

Note

- Record motion pictures in AVCHD format. [REC QUALITY] can be set to either  or .
- (P128)

 [VARIABLE MOVIE MODE]

Change the number of frames recorded and record motion pictures in slow and fast motion.

■ Slow motion/Fast motion setting

1 Select [FRAME RATE] and then press ►.

2 Press ▲/▼ to select the item and then press [MENU/SET].

[80%]: Record motion pictures at 0.8× speed

[160%]: Record motion pictures at 1.6× speed

[200%]: Record motion pictures at 2.0× speed

[300%]: Record motion pictures at 3.0× speed

- For example, when a motion picture is recorded for 10 seconds with [200%], the length of the recorded motion picture will be 5 seconds.



Note

- Display of the motion picture recording time at the top right of the screen is different from normal motion picture for [VARIABLE MOVIE MODE] playback.
[► XXmXXs]: Actual playback time
[📺 XXmXXs]: Actual recording time of the motion picture during recording
- Record motion pictures in AVCHD format. [REC QUALITY] can be set to either [24i] or [24i]. (P128)
- Audio is not recorded.
- [WIND CUT], [MIC LEVEL DISP.] and [MIC LEVEL ADJ.] in the [MOTION PICTURE] Mode menu cannot be used.
- We recommend using a tripod.

Changing the aperture/shutter speed manually and recording motion pictures

Select the following settings from [EXPOSURE MODE] in the [MOTION PICTURE] Mode menu. Rotate the rear dial on the recording screen to change the aperture value and shutter speed.

- Items that can be set will switch every time the rear dial is pressed.

[EXPOSURE MODE]	Items that can be set	
P (Programme AE Mode)	—	Exposure Compensation
A (Aperture-Priority AE Mode)	Aperture	Exposure Compensation
	F4.0 (Wide)/F5.8 (Tele) to F22 ^{*1} F3.5 (Wide)/F5.6 (Tele) to F22 ^{*2}	
S (Shutter-Priority AE Mode)	Shutter speed (Sec.)	Exposure Compensation
	1/25 to 1/4000th	
M (Manual Exposure Mode)	Shutter speed (Sec.)	Aperture
	1/25 to 1/4000th (when set to [AFS] or [AFC]) 1/2 to 1/4000th (when set to [MF])	F4.0 (Wide)/F5.8 (Tele) to F22 ^{*1} F3.5 (Wide)/F5.6 (Tele) to F22 ^{*2}

*1 When the 14–140 mm/F4.0–5.8 lens supplied in DMC-GH2H is used

*2 When the 14–42 mm/F3.5–5.6 lens supplied in DMC-GH2K is used

- Shutter speed changes depending on the selected Motion Picture Mode and [FRAME RATE] setting.
- You can change the settings and switch settable items even during motion picture recording. However please note that operating sounds may be recorded.

 **Note**
Aperture value

- Set the aperture value to a higher number when you want a sharp focus background. Set the aperture value to a lower number when you want a soft focus background.

Shutter speed

- When you want to take a sharp picture of a fast moving subject, set with a faster shutter speed. When you want to create a trail effect, set to a slower shutter speed.
 - Manually setting a higher shutter speed may increase the noise on-screen due to the higher sensitivity.
 - Colour or brightness of the image may change, or you may see horizontal bars on the sides of the image when the subject is recorded in an extremely bright place or under fluorescent light, mercury light, sodium light, etc. In this case, record in another recording mode or manually adjust the shutter speed to 1/60 or 1/100.
- Refer to “Recording Motion Picture” on P43 for other settings and operations for recording motion pictures.

[REC] Mode:            

Recording still pictures while recording motion pictures

Still pictures can be recorded even while recording a motion picture. (simultaneous recording)

During motion picture recording, press the shutter button fully to record a still picture.



- Simultaneous recording indicator  is displayed while recording still pictures.
- You can also take pictures using the Touch Shutter function (P38).















■ Setting motion picture and still picture priorities

- 1 Select [PICTURE MODE] from the [MOTION PICTURE] Mode menu. (P55)
- 2 Press / to select the item and then press [MENU/SET].

Item	Settings
 (Motion picture priorities)	<ul style="list-style-type: none"> • Pictures will be recorded with a picture size of [S] (2 M). The picture quality may be different to [S] (2 M) of standard pictures. • Only JPEG images are recorded when [QUALITY] is set to [RAW ], [RAW ] or [RAW]. (When set to [RAW], still pictures will be recorded in [QUALITY] of .) • Up to 30 still pictures can be recorded during recording of the motion picture.
 (Still picture priorities)	<ul style="list-style-type: none"> • Pictures will be recorded with the set picture size and quality. • The screen will go dark while recording pictures. A still picture will be recorded in the motion picture during that period, and audio is not recorded. • Up to 8 still pictures can be recorded during recording of the motion picture.

 **Note**

- The picture aspect ratio will be fixed to .
- Simultaneous recording is not possible in the following cases:
 - When [MOTION JPEG] is set to  or 
 - When [EX. TELE CONV.] is used [only when  (still picture priorities) is set]

[REC] Mode: **IA PASM1 2 3 SCN**

Taking a Picture with Face Recognition Function

Face Recognition is a function which finds a face resembling a registered face and prioritises focus and exposure automatically. Even if the person is located towards the back or on the end of a line in a group photo, the camera can still take a clear picture.

[FACE RECOG.] is initially set to [OFF] on the camera.

[FACE RECOG.] will turn [ON] automatically when the face image is registered.

- The following functions will also work with the Face Recognition function.



In Recording Mode

- Display of corresponding name when camera detects a registered face* (if name has been set for the registered face)
- The camera will remember the face that has been photographed many times and display the registration screen automatically (if [AUTO REGISTRATION] is set to [ON])

In Playback Mode

- Display of name and age (if information has been registered)
- Selective playback of pictures chosen from pictures registered with Face Recognition ([CATEGORY PLAY] (P143))

- * Names of up to 3 people are displayed. Precedence for the names displayed when taking pictures is determined according to the order of registration.

Note

- **[FACE RECOG.] only works when the AF Mode is set to [AF].**
- During the Burst Mode, [FACE RECOG.] picture information can be attached to only the first picture.
- After pressing the shutter halfway down, a different person's picture information may be added when the camera is turned to a different subject to photograph.
- [FACE RECOG.] cannot be used with the [FOOD] in [CLOSE-UP], [NIGHT SCENERY] and [PERIPHERAL DEFOCUS] in Scene Mode and in recording motion pictures.
- When the Focus Mode is set to [MF], automatic registration is not available.
- [FACE RECOG.] will find a face similar to the registered face, and does not guarantee secure recognition of a person.
- Face Recognition may take more time to select and recognise distinctive facial features than regular Face Detection.
- Even when face recognition information has been registered, pictures taken with [NAME] set to [OFF] will not be categorized by face recognition in [CATEGORY PLAY].
- **Even when Face Recognition information is changed (P113), Face Recognition information for the pictures already taken will not be changed.**
For instance, if the name is changed, pictures recorded before the change will not be categorized by face recognition in [CATEGORY PLAY].
- To change the name information of the pictures taken, perform the [REPLACE] in [FACE REC EDIT] (P153).

Face Settings

You can register information such as names and birthdays for face images of up to 6 people.

Registration can be facilitated by taking multiple face images of each person. (up to 3 pictures/registration)

■ Point of recording when registering the face images

- Face front with eyes open and mouth closed, making sure the outline of the face, the eyes, or the eyebrows are not covered with the hair when registering.
- Make sure there is no extreme shading on the face when registering. (Flash will not flash during registration.)

(Good example for registering)



■ When it is not recognising during recording

- Register the face of same person indoors and outdoors, or with different expressions or angles. (P113)
- Additionally register at the location of recording.
- Changing the [SENSITIVITY] setting. (P113)
- When a person who is registered is not recognised, correct by re-registering.

Example of faces that are hard to recognise

Face Recognition may not be possible or may not recognise faces correctly even for registered faces in the following instances, depending on the facial expression and environment.

- Hair is covering the eyes or the eyebrows (A)
- The face is dark/the light is at an angle (B)
- The face is facing in angle or sideways
- The face is facing upward/downward
- The eyes are closed
- When the face is extremely bright or dark
- Hidden by sunglasses, glasses reflecting light, hair, hat, etc.
- When the face appears small on the screen
- The entire face is not in the screen
- When distinctive facial features have changed with age
- When parents and children or siblings closely resemble one another
- Facial expression is very different
- When there is little contrast on the faces
- When there is rapid movement
- When the camera is shaking
- When Digital Zoom is used

(A)



(B)



■ Registering face image of new person

1 Select [FACE RECOG.] on the [REC] Mode menu and then press ►.
(P55)

2 Press ▲/▼ to select [MEMORY] and then press [MENU/SET].

3 Press ▲/▼/◀/▶ to select the face recognition frame that is not registered, and then press [MENU/SET].

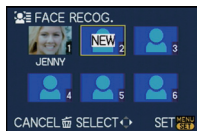

4 Take the picture adjusting the face with the guide.

- The faces of subjects other than people (pets, etc.) cannot be registered.
- When recognition fails, a message will appear and the display will return to the recording screen. In this case, try taking the picture again.



5 Press ▲ to select [YES] and then press [MENU/SET].

6 Select item to edit with ▲/▼, and then press ►.

- You can register up to 3 face images.

Item	Description of settings
[NAME]	<p>It is possible to register names.</p> <ol style="list-style-type: none"> 1 Press ▼ to select [SET] and then press [MENU/SET]. 2 Enter the name. <ul style="list-style-type: none"> • For details on how to enter characters, refer to “Entering Text” section on P117.
[AGE]	<p>It is possible to register the birthday.</p> <ol style="list-style-type: none"> 1 Press ▼ to select [SET] and then press [MENU/SET]. 2 Press ◀/▶ to select the items (Year/Month/Day), and then press ▲/▼ to set and then press [MENU/SET].
[ADD IMAGES]	<p>To add additional face images. (Add Images)</p> <ol style="list-style-type: none"> 1 Select the unregistered face recognition frame, and then press [MENU/SET]. 2 Perform steps 4 and 5 in “Registering face image of new person”. 3 Press [🗑️].
	<p>To delete one of the face images. (Delete)</p> <ol style="list-style-type: none"> 1 Press ◀/▶ to select the face image to delete, and then press [MENU/SET]. 2 Press ▲ to select [YES] and then press [MENU/SET]. 3 Press [🗑️]. <ul style="list-style-type: none"> • If there is only one image registered, it cannot be deleted.

7 Press the shutter button halfway to close the menu.

■ About the information ⓘ

- When [DISPLAY] is pressed on the recording screen described in step 4 on P111, an explanation appears for taking face images. (Press again to return to the recording screen.)

■ Change or delete the information for a registered person

You can modify the pictures or information of an already registered person. You can also delete the information of the registered person.

- 1 Select [FACE RECOG.] from the [REC] Mode menu, and then press ►. (P55)
- 2 Press ▼ to select [MEMORY] and press [MENU/SET].
- 3 Press ▲/▼/◀/▶ to select the face image to edit or delete and then press [MENU/SET].
- 4 Press ▲/▼ to select the item and then press [MENU/SET].

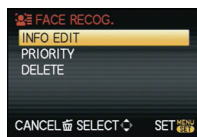

Item	Description of settings
[INFO EDIT]	Changing the information of an already registered person. Perform step 6 in “Registering face image of new person”.
[PRIORITY]	The focus and exposure are preferentially adjusted for higher-priority faces. Press ▲/▼/◀/▶ to select the priority and then press [MENU/SET].
[DELETE]	Deleting information of a registered person. Press ▲ to select [YES] and then press [MENU/SET].

- 5 Press the shutter button halfway to close the menu.

Setting Auto Registration/Sensitivity

Setting of Auto Registration and Sensitivity for Face Recognition can be done.

- 1 Select [FACE RECOG.] from the [REC] Mode menu, and then press ►. (P55)
- 2 Press ▼ to select [SET] and then press [MENU/SET].
- 3 Press ▲/▼ to select the item and then press ►.

Item	Description of settings
[AUTO REGISTRATION]	[OFF]/[ON] <ul style="list-style-type: none"> • When the [AUTO REGISTRATION] is set to [ON], [FACE RECOG.] will be set to [ON] automatically. • For details, see “Auto Registration” on P114.
[SENSITIVITY]	[HIGH]/[NORMAL]/[LOW] <ul style="list-style-type: none"> • Select [HIGH] when recognition proves to be difficult. The likelihood of recognition increases, but so does the likelihood of mistaken recognition. • Select [LOW] when mistaken recognition happens frequently. • To return to the original settings, select [NORMAL].

- 4 Press the shutter button halfway to close the menu.

■ Auto Registration

When [AUTO REGISTRATION] is set to [ON], the registration screen will display automatically after taking a picture of a face that has a high number of appearances.

- Registration screen is displayed after approximately 3 pictures.
- It may be extremely hard to recognise only with [AUTO REGISTRATION], so register the face images with [FACE RECOG.] in the [REC] Mode menu beforehand.

■ Registering from the automatic registration screen

1 Press ▲ to select [YES] and then press [MENU/SET].

- If there are no registered persons, proceed to step 3.
- Selection screen is displayed again when [NO] is selected, and when [YES] is selected with ▲, [AUTO REGISTRATION] will be set to [OFF].

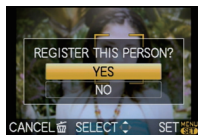

2 Press ▲/▼ to select [NEW PERSON] or [ADDITIONAL IMAGE] and then press [MENU/SET].

Item	Description of settings
[NEW PERSON]	• A list of registered people is displayed when there are 6 people already registered. Select the person to be replaced.
[ADDITIONAL IMAGE]	To additionally register a face image for a registered person. Press ▲/▼/◀/▶ to select the person to whom you wish add the picture, and then press [MENU/SET]. <ul style="list-style-type: none"> • If 3 images have already been registered, the picture replacement screen will appear. In this case, select the picture you wish to replace.

- After additionally registering or changing a face image, the screen returns automatically to the recording screen.

3 Perform the operation in Step 6 and following in “Registering face image of new person”.

Note

- If the registration screen will not display, it may display easier by recording in the same conditions or with the same expressions.
- If a face is not recognised even though it is registered, it will make the recognition easier by registering the person again using the [FACE RECOG.] in the [REC] Mode menu in that environment.
- If the registration screen is displayed for a person that is already registered, it will make the recognition easier by additionally registering.
- It may make recognition harder when a picture recorded with flash is registered.

[REC] Mode:

Useful Functions at Travel Destinations

Recording which Day of the Vacation You Take the Picture

For details on the [SETUP] menu settings, refer to P55.

If you set the departure date or the travel destination of the vacation in advance, the number of days that have passed since the departure date (which day of the vacation it is) is recorded when you take the picture. You can display the number of days that have passed when playing back the pictures and stamp it on the recorded pictures with [TEXT STAMP] (P145).

- The number of days that have passed since the departure date can be printed out using the "PHOTOfunSTUDIO 6.0 BD Edition" bundled software on the CD-ROM (supplied).

- Select [CLOCK SET] to set the current date and time in advance. (P31)

- 1 Select [TRAVEL DATE] from the [SETUP] menu, and then press ►.
- 2 Press ▲ to select [TRAVEL SETUP] and then press ►.
- 3 Press ▼ to select [SET] and then press [MENU/SET].
- 4 Press ▲/▼/◀/▶ to set the departure date (year/month/day), and then press [MENU/SET].

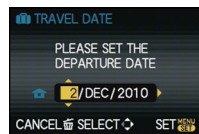

- 5 Press ▲/▼/◀/▶ to set the return date (year/month/day), and then press [MENU/SET].

- If you do not want to set the return date, press [MENU/SET] while the date bar is displayed.

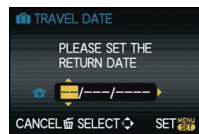

- 6 Press ▼ to select [LOCATION] and then press ►.
- 7 Press ▼ to select [SET] and then press [MENU/SET].
- 8 Enter the location.

- For details on how to enter characters, refer to "Entering Text" on P117.

- 9 Press [MENU/SET] twice to close the menu.

- The number of days that have passed since the departure date is displayed for about 5 seconds if this unit is turned on etc. after setting the travel date or when the travel date is set.
- When the travel date is set, appears on the lower right of the screen.

■ Cancelling the travel date

The travel date is automatically cancelled if the current date is after the return date. If you want to cancel the travel date before the end of the vacation, select [OFF] on the screen shown in step 3 or 7 and then press [MENU/SET] twice. If the [TRAVEL SETUP] is set to [OFF] in step 3, [LOCATION] will be also set to [OFF].

Note

- The travel date is calculated using the date in the clock setting and the departure date you set. If you set [WORLD TIME] (P116) to the travel destination, the travel date is calculated using the date in the clock setting and the travel destination setting.

- The travel date setting is memorised even if the camera is turned off.
- If [TRAVEL DATE] is set to [OFF], the number of days that have passed since the departure date will not be recorded. Even if [TRAVEL DATE] is set to [SET] after taking the pictures, which day of the vacation you took them is not displayed.
- If you set a departure date and then take a picture on a date before this departure date, [-] (minus) is displayed in orange and the day of the vacation that you took the picture is not recorded.
- If the travel date is displayed as [-] (minus) in white, there is a time difference that involves date change between the [HOME] and [DESTINATION]. (It will be recorded)
- [TRAVEL DATE] cannot be recorded for motion pictures recorded with [AVCHD].
- [LOCATION] cannot be recorded when taking motion pictures.
- [TRAVEL DATE] cannot be set in the Intelligent Auto Mode. Setting of other Recording Mode will be reflected.

Recording Dates/Times at Overseas Travel Destinations (World Time)

For details on the [SETUP] menu settings, refer to P55.

You can display the local times at the travel destinations and record them on the pictures you take.

• Select [CLOCK SET] to set the current date and time in advance. (P31)

1 Select [WORLD TIME] from the [SETUP] menu, and then press ►.

- When first using the camera after purchasing it, the [PLEASE SET THE HOME AREA] message appears. Press [MENU/SET], and set the home area on the screen in step 3.

2 Press ▼ to select [HOME], and then press [MENU/SET].

3 Press ◀/▶ to select the home area, and then press [MENU/SET].

- (A) Current time
- (B) Time difference from GMT (Greenwich Mean Time)
- If daylight saving time [☀/🌙] is used at the home area, press ▲. Press ▲ again to return to the original time.
- The daylight saving time setting for the home area does not advance the current time. Advance the clock setting by one hour.

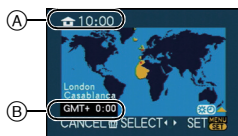

4 Press ▲ to select [DESTINATION] and then press [MENU/SET] to set.

- (C) Depending on the setting, the time at the travel destination area or the home area is displayed.

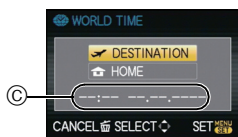

5 Press ◀/▶ to select the area the travel destination is in and then press [MENU/SET] to set.

- (D) Current time of the destination area
- (E) Time difference
- If daylight saving time [☀/🌙] is used at the travel destination, press ▲. (The time advances by one hour.) Press ▲ again to return to the original time.

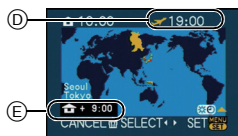

Note

- Return the setting to [HOME] when the vacation is finished by performing steps 1, 2 and 3.
- If [HOME] is already set, change only the travel destination, and use.
- If you cannot find the travel destination in the areas displayed on the screen, set by the time difference from the home area.

Entering Text

It is possible to enter babies' and pets' names and the names of travel destinations when recording. (Only alphabetical characters and symbols can be entered.)

1 Display the entry screen and press ▼ to move to the character selection section.

- You can display the entry screen via the following operations.
 - [NAME] of [BABY1]/[BABY2] or [PET] (P101) in Scene Mode.
 - [NAME] in [FACE RECOG.] (P112)
 - [LOCATION] in [TRAVEL DATE] (P115)
 - [TITLE EDIT] (P144)

2 Press ▲/▼/◀/▶ to select text and then press [MENU/SET] to register.

- Press [DISPLAY] to switch text between [A] (capitals), [a] (lower case) and [&/1] (special characters and numbers).
- The entry position cursor can be moved left and right with the rear dial.
- The following operations can be performed by moving the cursor to the item and pressing [MENU/SET]:
 - [SPACE]: Enter a blank
 - [DELETE]: Delete a character
 - [CANCEL]: Cancel entry/cancel edit
- A maximum of 30 characters can be entered. (Maximum of 9 characters when setting names in [FACE RECOG.]

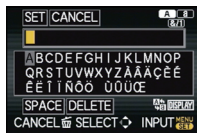

3 Press ▲/▼/◀/▶ to move the cursor to [SET] and then press [MENU/SET] to end text input.

- Display will return to the appropriate setting screen.

Note

- Text can be scrolled if all of the entered text does not fit on the screen.

Using the [REC] Mode Menu

• [FILM MODE], [METERING MODE], [I.DYNAMIC], [EX. TELE CONV.], and [DIGITAL ZOOM] are common to both the [REC] Mode menu and [MOTION PICTURE] Mode menu. Changing these settings in one of these menus is reflected in other menu.

For details on [REC] Mode menu settings, refer to P55.

[FILM MODE]

You can select up to 10 different colour tones and contrasts for the recorded pictures to match the recording conditions and aspects, as you would select different films for film cameras.

Applicable modes:           

[You can only select [STANDARD] (COLOUR) and [STANDARD] (B&W) in [TA], [SCN], [Hand icon], [Zoom icon] and [Flower icon] mode.]

[STANDARD] (COLOUR)/[DYNAMIC] (COLOUR)/[SMOOTH] (COLOUR)/[NATURE] (COLOUR)/[NOSTALGIC] (COLOUR)/[VIBRANT] (COLOUR)/[STANDARD] (B&W)/[DYNAMIC] (B&W)/[SMOOTH] (B&W)/[MY FILM 1]/[MY FILM 2]/[MULTI FILM]/[CINEMA] (COLOUR)

Note

- In Film Mode, the camera may do something equivalent to pull processing or push processing to create a picture with particular characteristics. The shutter speed may become very slow at this time.
- Use the Quick Menu (P56) to set when in Intelligent Auto Mode.

1 Touch [◀]/[▶] to select an item.

- When you touch [i] on the screen shown right, explanations about each Film Mode are displayed. (When you touch [CANCEL], the screen returns to the previous screen.)

2 Touch [SET].

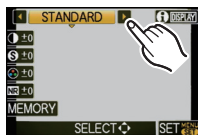

■ Adjusting each Film Mode to the desired setting

1 Touch the item.

2 Touch the slide bar.

- Registered settings are memorised even if the camera is turned off.

3 Touch [MEMORY].

4 Touch [MY FILM 1] or [MY FILM 2].

- You can register 2 settings. ([MY FILM 1] and [MY FILM 2]) (After registering, the Film Mode name that was registered previously is displayed.)
- [STANDARD] is registered in [MY FILM 1] and [MY FILM 2] at the time of purchase.

5 Touch [SET].



Item		Effect
☉ [CONTRAST]	[+]	Increases the difference between the brightness and the darkness in the picture.
	[-]	Decreases the difference between the brightness and the darkness in the picture.
Ⓢ [SHARPNESS]	[+]	The picture is sharply defined.
	[-]	The picture is softly focused.
⦿ [SATURATION]	[+]	The colours in the picture become vivid.
	[-]	The colours in the picture become natural.
NR [NOISE REDUCTION]	[+]	The noise reduction effect is enhanced. Picture resolution may deteriorate slightly.
	[-]	The noise reduction effect is reduced. You can obtain pictures with higher resolution.

Note

- Noise may become visible when you take pictures in dark places. To avoid picture noise, we recommend setting [NOISE REDUCTION] towards [+] or setting the items except [NOISE REDUCTION] towards [-] to take pictures.
- If you adjust a Film Mode, [+] is displayed beside the Film Mode icon on the screen.
- You cannot adjust [SATURATION] in the black and white settings in Film Mode.
- Film Mode cannot be adjusted in the Intelligent Auto Mode, Advanced Scene Mode and Scene Mode.

Multi Film Bracket

It will take pictures changing the type of film in accordance with the setting every time the shutter button is pressed. (Up to 3 pictures)

- 1 Touch [◀]/[▶] to select [MULTI FILM].
- 2 Select [MULTI FILM 1], [MULTI FILM 2], or [MULTI FILM 3], and then touch [◀]/[▶] to select the film to be set for each.
 - [OFF] can be selected only for [MULTI FILM 3].
- 3 Touch [SET].
 - Multi film indication ([MFM]) displayed on the screen will flash until all pictures of preset amount are taken.



Note

- Motion pictures are recorded with the settings for the [MULTI FILM 1] setting.

[ASPECT RATIO]

This allows you to select the aspect ratio of the pictures to suit printing or the playback method.

Applicable modes: **[iA] [P] [AS] [M] [C1] [C2] [C3] [SCN] [] [] [] []**

[4:3]: [ASPECT RATIO] of a 4:3 TV

[3:2]: [ASPECT RATIO] of a 35 mm film camera

[16:9]: [ASPECT RATIO] of a high-definition TV, etc.

[1:1]: Square aspect ratio

[4:3]



[3:2]



[16:9]

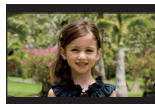

[1:1]

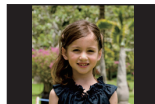

Note

- The ends of the recorded pictures may be cut at printing so check before printing. (P193)

[PICTURE SIZE]

Set the number of pixels. The higher the numbers of pixels, the finer the detail of the pictures will appear even when they are printed onto large sheets.

Applicable modes: **[iA] [P] [AS] [M] [C1] [C2] [C3] [SCN] [] [] [] []**

■ When the aspect ratio is **[4:3]**.

[L] (16M)	4608×3456 pixels
[EX] [M] (8M)	3264×2448 pixels
[EX] [S] (4M)	2336×1752 pixels

■ When the aspect ratio is **[3:2]**.

[L] (15M)	4752×3168 pixels
[EX] [M] (7.5M)	3360×2240 pixels
[EX] [S] (3.8M)	2400×1600 pixels

■ When the aspect ratio is **[16:9]**.

[L] (14M)	4976×2800 pixels
[EX] [M] (7M)	3520×1984 pixels
[EX] [S] (2M)	1920×1080 pixels

■ When the aspect ratio is [L].

L (12M)	3456×3456 pixels
EX M (6M)	2448×2448 pixels
EX S (3M)	1744×1744 pixels

Note

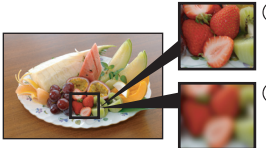
- If you set [EX. TELE CONV.] (P67) to [ON], [EX] is displayed on the screen when the picture size is set to a size other than the maximum picture size for each aspect ratio.
 - A digital picture is made of numerous dots called pixels. The higher the numbers of pixels, the finer the picture will be when it is printed on a large piece of paper or displayed on a PC monitor.
- 

(A) Many pixels (Fine)

(B) Few pixels (Rough)
- * These pictures are examples to show the effect.
 - If you change the aspect ratio, set the picture size again.
 - Refer to P30 for information about the number of recordable pictures.

📊 [QUALITY]

Set the compression rate at which the pictures are to be stored.

Applicable modes: **iA P A S M C1 C2 C3 SCN** 

- [📊]:** Fine (when giving priority to the picture quality)
- [📊]:** Standard (when using the standard picture quality and increasing the number of pictures to be recorded without changing the number of pixels)
- [RAW📊]:** RAW+Fine (In addition to the [RAW] settings, a fine-equivalent JPEG image is simultaneously created.)*¹
- [RAW📊]:** RAW+Standard (In addition to the [RAW] settings, a standard-equivalent JPEG image is simultaneously created.)*¹
- [RAW]:** RAW file (When the image is to be edited with a PC in high quality)*²

*¹ If you delete a RAW file from the camera, the corresponding JPEG image will also be deleted.

*² It is fixed to maximum recordable pixels ([L]) for each image aspect ratio.

Note

- Refer to P30 for information about the number of recordable pictures.
- You can enjoy more advanced picture editing if you use RAW files. You can save RAW files in a file format (JPEG, TIFF etc.) that can be displayed on your PC etc., develop them and edit them using the software “SILKYPIX Developer Studio” by Ichikawa Soft Laboratory on the CD-ROM (supplied).
- [RAW] images are recorded with a smaller data volume than [RAW📊] or [RAW📊].
- [PRINT SET] and [FAVORITE] cannot be set to a picture taken by [RAW].

 [FACE RECOG.]

[OFF]/[ON]/[MEMORY]/[SET]

 **Note**

- Refer to P109 for details.

 [METERING MODE]

Type of optical measurement to measure brightness can be changed.

Applicable modes: **P A S M C1 C2 C3**  

: Multiple

This is the method in which the camera measures the most suitable exposure by judging the allocation of brightness on the whole screen automatically. Usually, we recommend using this method.



: Centre weighted

This is the method used to focus on the subject on the centre of the screen and measure the whole screen evenly.

: Spot

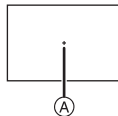
This is the method to measure the subject in the spot metering target .

 **Note**

- When the AF Mode is set to  while  is selected, exposure is adjusted to the face of a person, and when it is set to , exposure is adjusted to the locked subject.

 [STABILIZER]

[OFF]/[MODE1]/[MODE2]/[MODE3]

 **Note**

- Refer to P75 for details.

 [FLASH]

/[]/[]/[]/[]/[]

 **Note**

- Refer to P69 for details.

[RED-EYE REMOVAL]

[OFF]/[ON]

Note

- Refer to P70 for details.

[FLASH SYNCHRO]

2nd curtain synchro activates the flash just before the shutter closes when taking pictures of moving objects such as cars using a slow shutter speed.

Applicable modes: **P A S M C1 C2 C3 SCN**



[1ST]: 1st curtain synchro
The normal method when taking pictures with the flash.



[2ND]: 2nd curtain synchro
The light source appears behind the subject and picture becomes dynamic.



Note

- Set it to [1ST] normally.
- [2nd] is displayed in the flash icon on the screen if you set [FLASH SYNCHRO] to [2ND].
- The flash sync. settings are also effective when using an external flash. (P171)
- When a fast shutter speed is set, the effect of [FLASH SYNCHRO] may deteriorate.
- You cannot set [], [] or [] when [FLASH SYNCHRO] is set to [2ND].
- It can only be set with [PERIPHERAL DEFOCUS] in Scene Mode.

[FLASH ADJUST.]

Note

- Refer to P74 for details.

I.R [I.RESOLUTION]

Pictures with sharp profile and resolution can be taken by utilising the Intelligent Resolution Technology.

Applicable modes: **P A S M C1 C2 C3  **

[OFF]/[LOW]/[STANDARD]/[HIGH]/[EXTENDED]

Note

- [EXTENDED] allows you to take natural pictures with a higher resolution.
- The speed of burst and continuous recording becomes slower when [EXTENDED] is used.
- [EXTENDED] does not work during motion picture recording.
- Use the Quick Menu (P56) to set when in Creative Motion Picture Mode.

[I.DYNAMIC] (Intelligent dynamic range control)

Contrast and exposure will be adjusted automatically when there is a big difference in brightness between the background and subject, to bring the image close to how you see.

Applicable modes: **P A S M C1 C2 C3**   

[OFF]/[LOW]/[STANDARD]/[HIGH]

Note

- Compensation effect may not be achieved depending on the conditions.
- [] in the screen turns to yellow when [I.DYNAMIC] is in effect.
- [LOW], [STANDARD], or [HIGH] represents the maximum range of effect.

[ISO LIMIT SET]

It will select optimal ISO sensitivity with set value as limit depending on the brightness of the subject.

Applicable modes: **P A S M C1 C2 C3**

[OFF]/[200]/[400]/[800]/[1600]/[3200]

Note

- The upper limit of the ISO sensitivity can be set.
- The higher the value set for the ISO sensitivity, the more the jitter is reduced but the greater the amount of picture noise.
- It will work when the [SENSITIVITY] is set to [AUTO] or [].

[LONG SHTR NR]

The camera automatically removes noise that appears when the shutter speed becomes slower to take pictures of night scenery etc. so you can take beautiful pictures.

Applicable modes: **P A S M C1 C2 C3**    

[OFF]/[ON]

Note

- If you set [ON], the countdown screen is displayed when the shutter button is pressed. Do not move the camera at this time. After the countdown is finished, [PLEASE WAIT...] is displayed for the same time as the selected shutter speed for signal processing.
- We recommend using a tripod when the shutter speed is slowed to take pictures.
- This does not operate during motion picture recording.

[EX. TELE CONV.]

[OFF]/[ON]

Note

- Refer to P67 for details.

 [DIGITAL ZOOM]

[OFF]/[2×]/[4×]

 **Note**

- Refer to P67 for details.

 [BURST RATE]

[SH]/[H]/[M]/[L]

 **Note**

- Refer to P77 for details.

 [AUTO BRACKET]

[□/☰] [SETTINGS]/[STEP]/[SEQUENCE]

 **Note**

- Refer to P79 for details.

 [ASPECT BRACKET]

Pressing the shutter button once automatically takes four pictures with aspect ratios of [4:3], [3:2], [16:9] and [1:1].

Applicable modes: **P A S M C1 C2 C3 SCN**    

[OFF]/[ON]

 **Note**

- When setting Aspect Bracket, [] appears on the screen.
- Picture size is automatically changed to [M] when it is set to [S].
- When Aspect Bracket is set, the Auto Review function is activated regardless of the Auto Review setting. You cannot set the Auto Review function in the [SETUP] menu.
- [RAW₁], [RAW₂] or [RAW] for [QUALITY] cannot be set.
- This does not operate during motion picture recording.

 [SELF-TIMER]

[10]/[10]/[2]

 **Note**

- Refer to P81 for details.

 [COLOR SPACE]

Set this when you want to correct the colour reproduction of the recorded pictures on a PC, printer etc.

Applicable modes:            

[sRGB]: Colour space is set to sRGB colour space.
This is widely used in computer related equipment.

[AdobeRGB]: Colour space is set to AdobeRGB colour space.
AdobeRGB is mainly used for business purposes such as professional printing because it has a greater range of reproducible colours than sRGB.

 **Note**

- Depending on the colour space setting, the file name of the recorded picture changes as shown.

P1000001.JPG

	P: sRGB
	_ : AdobeRGB

- Set to sRGB if you are not very familiar with AdobeRGB.
- The setting is fixed to [sRGB] when recording motion pictures.

Using the [MOTION PICTURE] Mode Menu

- [FILM MODE], [METERING MODE], [I.DYNAMIC], [EX. TELE CONV.], and [DIGITAL ZOOM] are common to both the [REC] Mode menu and [MOTION PICTURE] Mode menu. Changing these settings in one of these menus is reflected in other menu.

–For details, refer to the explanation for the corresponding setting in [REC] Mode menu.

For details on [MOTION PICTURE] Mode menu settings, refer to P55.

[REC MODE]

This sets up the data format of motion pictures.

Applicable modes:             

 [AVCHD(1080i)]/[ [AVCHD(720p)]]

- Select this format to record HD (high-definition) video for playback on your HDTV using an HDMI connection.
- It can be played back as is by inserting the card into a device compatible with AVCHD. Refer to the instructions of the device used for details on compatibility.
- Use a card with SD Speed Class with “Class 4” or higher.
- [AVCHD(1080i)] can record motion pictures with even higher definition and picture quality than [AVCHD(720p)].

 [MOTION JPEG]]



- Select this format to record standard definition video for playback on your PC. It can be recorded using less storage when there is not much space left on the memory card or when you want to attach the motion picture to an e-mail.
- Use a card with SD Speed Class with “Class 6” or higher.

[REC QUALITY]



This sets up the picture quality of motion pictures.

Applicable modes:             



When [AVCHD(1080i)] is selected

Item	Quality (bit rate) ^{*1}	fps	Aspect ratio
 ([FSH])	1920×1080 pixels Approx. 17 Mbps ^{*2}	50i	16:9
 ([FH])	1920×1080 pixels Approx. 13 Mbps ^{*2}		

When [AVCHD(720p)] is selected

Item	Quality (bit rate) ^{*1}	fps	Aspect ratio
 ([SH])	1280×720 pixels Approx. 17 Mbps ^{*2}	50p	16:9
 ([H])	1280×720 pixels Approx. 13 Mbps ^{*2}		

When [24P CINEMA] or [VARIABLE MOVIE MODE] is selected in the Creative Motion Picture Mode

Item	Quality (bit rate) ^{*1}	fps	Aspect ratio
 ([24H])	1920×1080 pixels Approx. 24 Mbps ^{*2}	24p	16:9
 ([24L])	1920×1080 pixels Approx. 17 Mbps ^{*2}		

- To playback or import the motion pictures recorded in [] on equipment other than this unit, a compatible Blu-ray disk recorder or "PHOTOfunSTUDIO 6.0 BD Edition" is required. (P162)





*1 What is bit rate

This is the volume of data for definite period of time, and the quality becomes higher when the number gets bigger. This unit is using the "VBR" recording method. "VBR" is an abbreviation of "Variable Bit Rate", and the bit rate (volume of data for definite period of time) is changed automatically depending on the subject to record. Therefore, the recording time is shortened when a subject with fast movement is recorded.

*2 What is Mbps

This is an abbreviation of "Megabit Per Second", and it represents the speed of transmission.

When [MOTION JPEG] is selected

Item	Picture size	fps	Aspect ratio
 ([HD])	1280×720 pixels	30	16:9
 ^{*3} ([WVGA])	848×480 pixels		
 ([VGA])	640×480 pixels		4:3
 ([QVGA])	320×240 pixels		

*3 This item cannot be set in the Intelligent Auto Mode.

- With the [AVCHD] or [] for [MOTION JPEG], high quality motion picture can be enjoyed on the TV by using the HDMI mini cable (optional). For details, see "Playing back on the TV with HDMI socket" on P158.

[EXPOSURE MODE]

[P]/[A]/[S]/[M]

Note

- Refer to P107 for details.

[PICTURE MODE]

[] (Motion picture priorities)/[] (Still picture priorities)

Note

- Refer to P108 for details.

 [CONTINUOUS AF]

[OFF]/[ON]

 **Note**

- Refer to P43 for details.

 [WIND CUT]

This reduces the wind noise in the audio recording.

Applicable modes:              

[OFF]/[LOW]/[STANDARD]/[HIGH]

 **Note**

- Sound quality will be different than usual when [WIND CUT] is set.

 [MIC LEVEL DISP.]

Set whether or not the mic levels are displayed on the screen.

Applicable modes:             

[OFF]/[ON]

 [MIC LEVEL ADJ.]

Adjust the sound input level to 4 different levels.

Applicable modes:             

[LEVEL1] to [LEVEL4]

 [REC HIGHLIGHT]

White saturated areas appear blinking in black and white.

Applicable modes: 

[OFF]/[ON]

 **Note**

- If there are any white saturated areas, we recommend compensating the exposure towards negative (P76) referring to the histogram (P66) and then taking the picture. It may result in a better quality picture.

Perform these settings if you need to.

Using the [CUSTOM] Menu

For details on how to select the [CUSTOM] menu settings, refer to P55.

[CUST. SET MEM.]	[C1]/[C2]/[C3]
------------------	----------------

- Refer to P105 for details.

[Fn BUTTON SET]	—
-----------------	---

- Refer to P18 for details.

[HISTOGRAM]	[OFF]/[ON]
-------------	------------

- Refer to P66 for details.

[GUIDE LINE]	[OFF]/[]/[]/[]
--------------	-------------------------------------------------------------------------------------------------------------------------------------------------------------------------------------------------------------------------------------------------------------------------

- Refer to P65 for details.

[HIGHLIGHT]	When the Auto Review function is activated or when playing back, white saturated areas appear blinking in black and white.
	[OFF]/[ON]

- If there are any white saturated areas, we recommend compensating the exposure towards negative (P76) referring to the histogram (P66) and then taking the picture again. It may result in a better quality picture.

- There may be white saturated areas if the distance between the camera and the subject is too close when taking pictures with the flash.

[ON]



[OFF]



- If [HIGHLIGHT] is set to [ON] in this case, the area directly illuminated by the photo flash will become white saturated and appear blinking in black and white.

- The LCD/LVF will display overexposed portions of the image as white blinking areas. These only exist on the camera's display, not on the actual photo.

- This does not work while in Multi Playback (P40), Calendar Playback (P41), or Playback Zoom (P42).

[AF/AE LOCK]	[AE]/[AF]/[AF/AE]
--------------	-------------------

- Refer to P87 for details.

[AF/AE LOCK HOLD]	This will set the operation of [AF/AE LOCK] button when taking a picture with fixed focus or exposure.
	<p>[OFF]: The focus and the exposure are fixed only while you are pressing [AF/AE LOCK]. (P87) If you release [AF/AE LOCK], AF/AE Lock is cancelled.</p> <p>[ON]: The focus and the exposure remain fixed even if you release [AF/AE LOCK] after pressing it. If you press [AF/AE LOCK] again, AF/AE Lock is cancelled.</p>

[PRE AF]	Depending on the setting, camera will adjust the focus automatically before pressing the shutter button halfway.
	<p>[OFF]</p> <p>[Q_{AF}]: Quick AF</p> <p>[C_{AF}]: Continuous AF</p>

About [Q_{AF}] and [C_{AF}]

[Q_{AF}] will adjust the focus automatically when the jitter of the camera gets small. [C_{AF}] will adjust the focus at all times (continuous AF operation).

The camera will adjust the focus automatically, and the focus adjustment when the shutter button is pressed becomes faster. It is effective when you do not want to miss the photo opportunity.

Note

- The battery will be consumed faster than usual.
- Press the shutter button halfway again when it is difficult to focus on the subject.
- When [PRE AF] is set to [C_{AF}], it may take time to focus on the subject if you rotate the zoom ring from Wide to Tele or suddenly change the subject from a distant one to a nearby one.
- [PRE AF] does not work during the Preview Mode.
- [PRE AF] will not work in low illumination.
- [PRE AF] does not work with lenses that do not allow Auto Focus and Four Thirds mount specification lens not compatible to contrast AF. [C_{AF}] does not work with lenses for which the Focus Mode cannot be set to [AFC]. (P20)

[DIRECT FOCUS AREA]	[OFF]/[ON]
----------------------------	-------------------

- Refer to P84, 85 for details.

[FOCUS PRIORITY]	It will set so no picture can be taken when it is out of focus.
	<p>[OFF]: This gives priority to the best time to take a picture so you can take a picture when the shutter button is pressed fully.</p> <p>[ON]: You cannot take a picture until the subject is brought into focus.</p>

- If you set [OFF], be careful as the picture may not be properly focused even if [AFS] or [AFC] in Focus Mode is set.
- This does not operate during motion picture recording.

[SHUTTER AF]	Set whether or not the focus is adjusted automatically when the shutter button is pressed halfway.
	[OFF]/[ON]

[AF ASSIST LAMP]	Illuminating the subject makes it easier for the camera to focus when recording in low light conditions that make focusing difficult.
	<p>[OFF]: The AF Assist Lamp does not turn on.</p> <p>[ON]: When taking pictures in dark places, the AF Assist Lamp lights while the shutter button is pressed halfway. (Larger AF areas are displayed depending on the recording conditions.)</p>

- The effective range of the AF Assist Lamp is different depending on used lens.
 - When the 14–140 mm/F4.0–5.8 lens supplied in DMC-GH2H is attached and at Wide: Approx. 1.0 m (3.28 feet) to 3.0 m (9.84 feet)
 - When the 14–42 mm/F3.5–5.6 lens supplied in DMC-GH2K is attached and at Wide: Approx. 1.0 m (3.28 feet) to 3.0 m (9.84 feet)
- The AF Assist Lamp is valid only for the subject in the centre of the screen. Use it by positioning the subject in the centre of the screen.
- Remove the lens hood.
- When you do not want to use the AF Assist Lamp (e.g. when taking pictures of animals in dark places), set the [AF ASSIST LAMP] to [OFF]. In this case, it will become more difficult to focus on the subject.
- The AF Assist Lamp gets slightly blocked when the lens supplied in the DMC-GH2H/DMC-GH2K is used, but it does not affect the performance.
- The AF Assist Lamp may be greatly blocked, and it may become harder to focus when a lens with large diameter is used.
- The setting for the [AF ASSIST LAMP] is fixed to [OFF] in [SCENERY] Mode and [NIGHT SCENERY], [SUNSET] in Scene Mode.





[AF+MF]	It is possible to adjust focus manually after it was adjusted automatically.
	<p>[OFF]</p> <p>[ON]: It is possible to finely adjust the focus manually by rotating the focus ring while AF lock (Focus Mode is set to [AFS] and shutter button is half-way pressed, or AF lock with [AF/AE LOCK]).</p>

[MF ASSIST]	[OFF]/[ON]
--------------------	-------------------

- Refer to P85 for details.

[MF GUIDE]	[OFF]/[ON]
-------------------	-------------------

- Refer to P85 for details.

[PREVIEW HOLD]	This will set the operation of the  button when displaying the preview screen.
	<p>[OFF]: Preview screen is displayed only when the  is pressed. It will return to previous screen when  is released.</p> <p>[ON]: Preview screen is displayed even after the  is released after pressing. (P96) It will return to previous screen when  is pressed again.</p>

[CONSTANT PREVIEW]	[OFF]/[ON]
---------------------------	-------------------

- Refer to P95 for details.



[EXPO.METER]	Select whether or not to display the exposure meter when the mode dial is switched to P/A/S/M etc.
	[OFF]/[ON]

- Set to [ON] to display the [EXPO.METER] when correcting exposure, performing programme shift, setting aperture, and setting shutter speed.
- Unsuitable areas of the range are displayed in red.
- When [EXPO.METER] is not displayed, switch the display information for LCD monitor/viewfinder by pressing [DISPLAY]. (P64)
- The [EXPO.METER] disappears after approximately 4 seconds if no operation is performed.





[EXPO. SETTINGS]	Change the method of Exposure Compensation setting switching when the mode dial is set to P , A , S and M .
	<p>[SWITCH BY PRESSING THE REAR DIAL]: Press the rear dial to switch between Exposure Compensation, Programme Shift, aperture setting, and shutter speed setting.</p> <p>[SWITCH BY PRESSING THE LVF/LCD BUTTON]: Press [LVF/LCD] to switch between Exposure Compensation, Programme Shift, aperture setting, and shutter speed setting.</p>



Setting items for each [REC] Mode

		 or 
P	Programme Shift	Exposure Compensation
A	Aperture	Exposure Compensation
S	Shutter speed	Exposure Compensation
M	Shutter speed	Aperture



- You cannot switch between LCD monitor and viewfinder by pressing [LVF/LCD] when it is set to [SWITCH BY PRESSING THE LVF/LCD BUTTON].
- [EXPO. SETTINGS] is disabled when you set [AUTO SWITCH] in [LVF/LCD SWITCH] to [OFF].

[LVF DISP.STYLE]	[]/[]
------------------	-------------------------------------------------------------------------------------------------------------------------------------------------------------------------

- Refer to P64 for details.

[LCD DISP.STYLE]	[]/[]
------------------	-----------------------------------------------------------------------------------------------------------------------------------------------------------------------------



- Refer to P64 for details.

[LCD INFO.DISP.]	This will set the colour of the information display screen on the LCD monitor. (P64)
	[OFF]
	[]: Black colours
	[]: Grey colours
	[]: Silver colours



[LVF/LCD SWITCH]	It will switch automatically to viewfinder display when an eye or object gets near the viewfinder using an eye sensor. It will return to LCD monitor display when it goes away.
	[AUTO SWITCH]: Enables/disables the eye sensor. [OFF]/[ON]
	[SENSITIVITY]: This will set the sensitivity of the eye sensor. [LOW]/[HIGH]

- LCD monitor display and viewfinder display can be switched manually by pressing [LVF/LCD]. (P16)

[ BUTTON]	Enables/disables the motion picture button.
	[OFF]/[ON]

[ REC AREA]	This changes the angle of view during motion picture recording and still picture recording.
	[] (Picture)/[] (Motion picture)

- The recording area indicated is a guide line.

[REMAINING DISP.]	This will switch display between the number of recordable pictures and available recording time.
	 [REMAINING SHOTS]: This will display the number of recordable pictures for still pictures.
	 [REMAINING TIME]: This will display the available recording time for motion pictures.

[TOUCH Q.MENU]	Enables/disables the Quick Menu during the touch operation.
	[OFF]: Setting for not using the Touch Quick Menu. [Q. MENU] is not displayed on the recording screen.
	[ON]: The Touch Quick Menu can be used.

[TOUCH SHUTTER]	Enables/disables the Touch Shutter function.
	[OFF]: Setting for not using the Touch Shutter function. [ is not displayed on the recording screen.
	[ON]: The Touch Shutter function can be used.

[TOUCH GUIDE]	When playing back the pictures, this allows you to set either to display or not display the guide screen of the touch panel.
	[OFF]/[ON]

[TOUCH SCROLL]	This allows you to set the speed of continuously forwarding or rewinding pictures using touch operation.
	[H]: High speed
	[L]: Low speed

[DIAL GUIDE]	Sets if the operation switch guide when the mode dial is switched to P , A , S and M is to be displayed or not.
	[OFF]/[ON]

- It will display dial operation guide to the screen that is possible to perform Exposure Compensation, Programme Shift, aperture setting, or shutter speed setting when set to [ON].

Ⓐ Dial operation guide



Ⓐ

[MENU RESUME]	The last operated menu position is saved even if the camera is turned off.
	[OFF]/[ON]

[PIXEL REFRESH]	It will perform optimization of imaging device and image processing.
------------------------	----------------------------------------------------------------------

- Imaging device and image processing is optimised when the camera is purchased. Use this function when bright spots not in subject get recorded, and it is bothering you.
- Turn the camera off and on after the pixels are corrected.

[SENSOR CLEANING]	Dust reduction to blow off the debris and dust that have affixed to the front of the imaging device is performed.
--------------------------	-------------------------------------------------------------------------------------------------------------------

- Dust reduction function will operate automatically when the camera is turned on, but you can use this function when you see dust. (P178)

[SHOOT W/O LENS]	It is possible to setup so the shutter will not operate when there is no lens on the unit.
	[OFF]: You cannot press the shutter button when a lens is not attached to the camera body or is not attached correctly. [ON]: Shutter will operate regardless of the lens on the unit.

- When using a Leica lens mount adaptor (DMW-MA2M, DMW-MA3R; optional), set it to [ON].

Playing Back Burst Pictures

■ About the burst picture group

The pictures taken with burst speed set to [SH] are recorded together as a burst group with the burst icon [📷].

Ⓐ Burst icon

- Continuous playback and multi playback in a group unit is possible.
- Deleting and editing in a group unit is possible. (For example, if you delete a burst picture group with [📷], all the pictures in that group are deleted.)
- It is also possible to delete or edit single pictures within the group.
- Burst pictures recorded after the number of pictures has exceeded 50000 will not be grouped.
- Burst pictures recorded on other cameras may not be recognised as a burst picture group.
- Burst pictures will not be grouped if recorded without setting the clock.



Continuously playing back burst pictures

1 Select a picture with a burst icon [📷], and then touch [▶] to play back.

- Burst pictures are continuously played back.
- Pressing the cursor button ▲ to allows you to playback burst pictures. Display at the bottom right of the screen while playing back corresponds to ▲/▼/◀/▶ on the cursor button.

2 Touch [■] to finish the continuous playback.

- It will resume normal playback once the continuous playback has finished.

■ Operations during burst picture group playback

Drag the screen horizontally and select an image.*1

Forward: drag from right to left

Rewind: drag from left to right

- Touch [▶] during playback to fast forward (touch [◀] to rewind).
- You can zoom while paused.
- Pause and rotate the rear dial left for multi playback of the pictures in the burst picture group.

Ⓐ Fast rewind, Previous picture*2

Ⓑ Play/Pause

Ⓒ Fast forward, Next picture*2

Ⓓ Stop

*1 These operations can be performed only in the Pause Mode.

*2 These operations can be performed only in the Pause Mode and the following icons are displayed.

– Previous picture: [◀◀]

– Next picture: [▶▶]

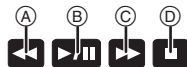
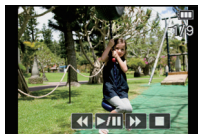

Editing Burst Pictures

You can edit the pictures in the burst picture group as single pictures or in group units (including all pictures in group).

■ Editing single pictures within a burst picture group

- The following editing menu can be used.
 - [TITLE EDIT] (P144), [TEXT STAMP] (P145), [CROPPING] (P148), [ASPECT CONV.] (P148), [FAVORITE] (P150), [PRINT SET] (P151), [PROTECT] (P152)

To select an image during continuous playback of burst pictures (Burst Play menu)

- Select an image during continuous playback, and pause by touching [⏏].**
- Press [MENU/SET] to display the [PLAYBACK] Mode menu.**
- Press ▲/▼ to select the item, and press ►.**
- Press ▲/▼ to select [SINGLE] or [MULTI] and then press [MENU/SET].**
 - You cannot select [SINGLE] or [MULTI] when [CROPPING] or [ASPECT CONV.] is selected.
- Select the picture, and perform editing.**

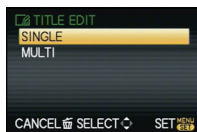

For details on the various ways of editing, refer to “Using the [PLAYBACK] Mode Menu” (P141).

To select an image during normal playback

- Select the item on the [PLAYBACK] mode menu and then press ►. (P55)**
- Press ▲/▼ to select [SINGLE IN BURST GROUP] or [MULTI IN BURST GROUP] and then press [MENU/SET].**
 - When [CROPPING] or [ASPECT CONV.] is selected, [MULTI IN BURST GROUP] will not appear.
 - Only the burst picture groups with burst icon [⏏] are displayed.
- Select the burst picture group and then press [MENU/SET].**
 - Pictures within the group are displayed.
- Select the picture, and perform editing.**

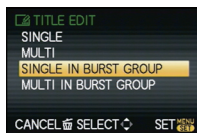

For details on the various ways of editing, refer to “Using the [PLAYBACK] Mode Menu” (P141).

■ Editing in burst picture group units

All pictures in the burst picture group are edited at once.

- For burst picture groups, the following editing menu can be used.
 - [TITLE EDIT] (P144), [TEXT STAMP] (P145), [FAVORITE] (P150), [PRINT SET] (P151), [PROTECT] (P152), [FACE REC EDIT] (P153)

- Select the item on the [PLAYBACK] mode menu and then press **▶**. (P55)
- Press **▲/▼** to select [SINGLE] or [MULTI] and then press [MENU/SET].



- Select an image with burst icon  (A), and perform editing.

- You can select multiple pictures from the burst picture group and other images by selecting [MULTI] in step 2.

For details on the various ways of editing, refer to “Using the [PLAYBACK] Mode Menu” (P141).



■ About display of [FAVORITE], [PRINT SET] and [PROTECT] icons during playback of burst picture groups.

If you set [FAVORITE] (P150), [PRINT SET] (P151) or [PROTECT] (P152) for any of the pictures in the burst picture group, the following icons will appear on the group top screen.

Initial screen for burst picture group	[FAVORITE]	[PRINT SET]	[PROTECT]
			

- (A) Total number of all pictures stored within the burst picture group.
 (B) Number of pictures in given burst picture group subject to a setting.
 (C) Total number of prints set over all burst picture groups.
 • For example, if 3 pictures are to be printed from each of 2 burst pictures within the group, a "6" will appear here.

Note

- [CROPPING] and [ASPECT CONV.] is not possible at once on the burst picture group units.
- Pictures for which you have performed [TEXT STAMP], [CROPPING] or [ASPECT CONV.] will be saved separately from burst pictures.
- If you delete all pictures except one, that picture will be saved as a single picture instead of as a burst picture group.

Creating Still Pictures from a Motion Picture

You can create a single still picture from a recorded motion picture.

1 Touch [] during Motion Picture playback by touch operation.

- Motion picture is paused.

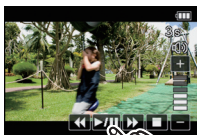

2 Touch [SAVE].

3 Touch [YES].

4 Touch [] to finish.

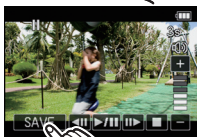

Note

- It will be saved with [PICTURE SIZE] set to [S] (2 M), [ASPECT RATIO] set to [16:9], and [QUALITY] set to [].
- Still pictures created from a motion picture may be coarser than with normal picture quality.
- Still pictures cannot be created from motion pictures recorded with [MOTION JPEG] set to [] or [].
- You may not be able to save still pictures from a motion picture taken on other equipment.
- [] is displayed during playback of still pictures created from motion pictures.

Using the [PLAYBACK] Mode Menu

You can use various functions in playback mode to rotate pictures, set protection for them etc.

- With [TEXT STAMP], [RESIZE], [CROPPING] or [ASPECT CONV.], a new edited picture is created. A new picture cannot be created if there is no free space on the card so we recommend checking that there is free space and then editing the picture.

[2D/3D SETTINGS]

Playback methods for the 3D pictures can be switched.

- This is a menu that is only displayed when 3D display is possible. Refer to P155 for details.

[SLIDE SHOW]

You can play back the pictures you have taken in synchronisation with music, and you can do this in sequence while leaving a fixed interval between each of the pictures.

You can also put together a slide show composed of only still pictures, only motion pictures, only 3D pictures, only pictures of a particular category, or only favourites.

We recommend this feature when you view your pictures by connecting the camera to a TV.

1 Select [SLIDE SHOW] on the [PLAYBACK] Mode menu. (P55)

2 Press ▲/▼ to select the item and then press [MENU/SET].

- [FAVORITE] can be selected only when [FAVORITE FUNC.] on the [SETUP] menu (P62) is at [ON] and there are pictures already set as favourites.
- During [CATEGORY SELECTION], press ▲/▼/◀/▶ to select a category, and then press [MENU/SET] to proceed to step 3.
For details on categories, refer to P143.
- Refer to P155 for the method to playback [3D] pictures in 3D.

3 Press ▲ to select [START] and then press [MENU/SET].

4 Press ▼ to finish the slide show.

- Normal Playback resumes after the slide show finishes.

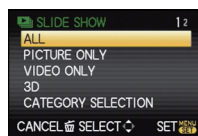

■ Operations performed during slide show

The cursor displayed during playback is the same as ▲/▼/◀/▶.

- The menu screen is restored when [⏏] is pressed.

- (A) Play/Pause
- (B) Stop
- (C) Back to previous picture*
- (D) Ahead to next picture*

* These operations can be performed only in the Pause Mode, during motion picture and burst picture group playback.

- (E) Reduce volume level
- (F) Increase volume level

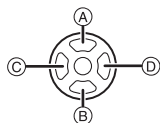

■ Changing the slide show settings

You can change the settings for slide show playback by selecting [EFFECT] or [SETUP] on the slide show menu screen.

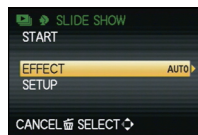

[EFFECT]

This allows you to select the screen effects when switching from one picture to the next.

[NATURAL], [SLOW], [SWING], [URBAN], [OFF], [AUTO]

- When [URBAN] has been selected, the picture may appear in black and white as a screen effect.
- [AUTO] can be used only when [CATEGORY SELECTION] has been selected. The pictures are played back with the recommended effects in each category.
- [EFFECT] is fixed to [OFF] when in [VIDEO ONLY] or during the slide show for [] in [CATEGORY SELECTION].
- Even if [EFFECT] is set, it does not work during a slide show of burst picture group.
- Some [EFFECT] will not operate when playing back pictures displayed vertically.

[SETUP]

[DURATION] or [REPEAT] can be set.

Item	Settings
[DURATION]	1SEC./2SEC./3SEC./5SEC.
[REPEAT]	OFF/ON
[SOUND]	<p>[OFF]: There will be no sound.</p> <p>[AUTO]: Music is played when the still pictures are played back, and audio is played when the motion pictures are played back.</p> <p>[MUSIC]: Music is played back.</p> <p>[AUDIO]: Audio (only for motion pictures) is played back.</p>

- [DURATION] can be set only when [OFF] has been selected as the [EFFECT] setting.
- Even if [DURATION] is set, it does not work during a slide show of motion pictures only or slide show of burst picture group.

Note

- It is not possible to add new music.
- Audio is not played back even if set to [AUDIO] or [AUTO] during [VARIABLE MOVIE MODE] playback.

 [PLAYBACK MODE]

Playback in [NORMAL PLAY], [PICTURE PLAY], [AVCHD PLAY], [MOTION JPEG PLAY], [3D PLAY], [CATEGORY PLAY] or [FAVORITE PLAY] can be selected.



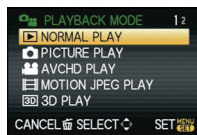

1 Select [PLAYBACK MODE] on the [PLAYBACK] Mode menu. (P55)
2 Press ▲/▼ to select the item and then press [MENU/SET].



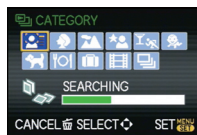



- [FAVORITE PLAY] can be selected only when [FAVORITE FUNC.] on the [SETUP] menu (P62) is at [ON] and there are pictures already set as favourites.
- Refer to P155 for the method to playback [3D PLAY] pictures in 3D.

When [CATEGORY PLAY] is selected in step 2
3 Press ▲/▼/◀/▶ to select the category and then press [MENU/SET] to set.

- If a picture is found in a category, the category icon turns blue.
- It may take time to search the picture files if there are a lot on the card.
- If you press [STOP] while searching, the searching will stop halfway.
- Pictures are sorted into the categories shown below.



[CATEGORY]	Recording information e.g. Scene Modes
	[FACE RECOG.]*
	[PORTRAIT], [i-PORTRAIT], [NIGHT PORTRAIT], [i-NIGHT PORTRAIT], [BABY1]/[BABY2], [i-BABY]
	[SCENERY], [i-SCENERY], [SUNSET], [i-SUNSET]
	[NIGHT PORTRAIT], [i-NIGHT PORTRAIT], [NIGHT SCENERY], [i-NIGHT SCENERY]

[CATEGORY]	Recording information e.g. Scene Modes
	[SPORTS], [PARTY]
	[BABY1]/[BABY2], [i-BABY]
	[PET]
	[FOOD]
	[TRAVEL DATE]
	Motion pictures
	Still pictures recorded with burst speed set to [SH]

- *Press ▲/▼/◀/▶ to select the person to playback and then press [MENU/SET].
Face Recognition may not be possible or may not recognise faces correctly even for registered faces, depending on the facial expression and environment.
Also, if there are multiple faces that are already registered in the picture, it will be categorized only once to the person found first in the registration.

 [TITLE EDIT]

You can add text (comments) to pictures. After text has been registered, it can be stamped in prints using [TEXT STAMP] (P145). (Only alphabetic characters and symbols can be entered.)

1 Select [TITLE EDIT] on the [PLAYBACK] Mode menu. (P55)

2 Press ▲/▼ to select the item and then press [MENU/SET].

- When [SINGLE IN BURST GROUP] or [MULTI IN BURST GROUP] is selected, press ▲/▼/◀/▶ to select burst picture group, and press [MENU/SET] to proceed to step **3**.



3 Select the picture, and then press [MENU/SET] to set.

- [✔] is displayed for pictures with titles already registered.

[MULTI] setting

Press [DISPLAY] to set (repeat), and then press [MENU/SET] to set.

- The setting is cancelled when [DISPLAY] is pressed again.

[SINGLE]

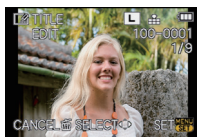

[MULTI]

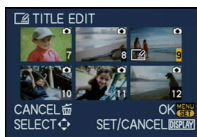

Press ◀/▶ to select the picture. Press ▲/▼/◀/▶ to select the pictures.

4 Enter the text. (P117)

- Press [⏮] to return to the menu screen. (The menu screen is automatically restored when [MULTI] is selected.)



Note

- To delete the title, erase all the text in the text input screen.
- Text can be scrolled if all of the registered text does not fit on the screen.
- You can print out texts (comments) using the "PHOTOfunSTUDIO 6.0 BD Edition" bundled software on the CD-ROM (supplied).
- You can set up to 100 pictures at one time with [MULTI].
- You cannot use title edit for the following pictures.
 - Motion pictures
 - Pictures taken with [RAW] or [RAW] or [RAW]
 - Pictures recorded with other equipment

 [TEXT STAMP]

You can stamp the recording date/time, name, location, travel date or title onto the recorded pictures.

It is suitable for regular size printing. (Pictures with a picture size larger than [S] will be resized when stamping the date etc. on them.)

1 Select [TEXT STAMP] on the [PLAYBACK] Mode menu. (P55)

2 Press ▲/▼ to select the item and then press [MENU/SET].

- When [SINGLE IN BURST GROUP] or [MULTI IN BURST GROUP] is selected, press ▲/▼/◀/▶ to select burst picture group, and press [MENU/SET] to proceed to step **3**.



3 Select the picture, and then press [MENU/SET] to set.

-  appears on screen if the picture is stamped with text.

[MULTI] setting

Press [DISPLAY] to set (repeat), and then press [MENU/SET] to set.

- The setting is cancelled when [DISPLAY] is pressed again.

[SINGLE]



Press ◀/▶ to select the picture.



[MULTI]



Press ▲/▼/◀/▶ to select the pictures.

4 Press ▲/▼ to select text stamp items, and then press ▶.

5 Press ▲/▼ to select the settings, and then press [MENU/SET].

Item	Setting item
[SHOOTING DATE]	<p>[OFF]</p> <p>[W/OTIME]: Stamp the year, month and date.</p> <p>[WITHTIME]: Stamp the year, month, day, hour and minutes.</p>
[NAME]	<p>[OFF]</p> <p>: Name registered in Face Recognition will be stamped.</p> <p>: Stamps names on pictures that already have been registered name settings of [BABY1]/[BABY2] or [PET] in Scene Mode.</p>
[LOCATION]	<p>[OFF]</p> <p>[ON]: Stamps the travel destination name set under [LOCATION].</p>
[TRAVEL DATE]	<p>[OFF]</p> <p>[ON]: Stamps the travel date set under [TRAVEL DATE].</p>
[TITLE]	<p>[OFF]</p> <p>[ON]: Title input in the [TITLE EDIT] will be stamped.</p>

6 Press [MENU/SET].

- When selecting [] or [], press ▲ to select [YES] for stamping [AGE], and then press [MENU/SET] and proceed to step 7.

7 Press ▲ to select [YES] and then press [MENU/SET].

- Press [] to return to the menu screen. (The menu screen is automatically restored when [MULTI] is selected.)

Note

- When you print pictures stamped with text, the date will be printed over the stamped text if you specify printing of the date at the photo shop or on the printer.
- You can set up to 100 pictures at one time in [MULTI].
- The picture quality may deteriorate when text stamping is carried out.
- Depending on the printer being used, some characters may be cut at printing. Check before printing.
- Text and dates cannot be stamped on the pictures in the following cases.
 - Motion pictures
 - Pictures recorded without setting the clock and title
 - Pictures that were previously stamped with [TEXT STAMP]
 - Pictures taken with [RAW], [RAW] or [RAW]
 - Pictures recorded with other equipment

[] [VIDEO DIVIDE]

Recorded motion picture can be divided in two. It is recommended for when you want to divide a part you need with a part you do not need.

It cannot be restored once divided.

1 Select [VIDEO DIVIDE] on the [PLAYBACK] Mode menu. (P55)**2 Press ◀/▶ to select the motion picture to divide, and then press [MENU/SET].**

- Motion picture is played back.

3 Press ▲ at the location to divide.

- Motion picture is paused.
Motion picture is played back from the same location when ▲ is pressed again.
- You can finely adjust the location for division by pressing ◀/▶ while the motion picture is paused.

**4 Press ▼.****5 Press ◀ to select [YES] and then press [MENU/SET].**

- Motion picture may be lost if the card or battery is removed while processing the dividing.
- Press [] to return to the menu screen.

Note

- Motion pictures cannot be divided at a location close to the start or end of the motion picture.
- [VIDEO DIVIDE] may not be performed on motion pictures recorded with other equipment.
- With [MOTION JPEG] motion pictures, the order of pictures will change if divided.
It is recommended to display these motion pictures by using Calendar Playback (P41) or [MOTION JPEG PLAY] in the [PLAYBACK MODE] (P143).
- With [AVCHD] motion pictures, the order of pictures will not change.
- Motion pictures cannot be divided in the following cases.
 - Motion pictures with a short recording time

[RESIZE] Reducing the picture size (number of pixels)

To allow easy posting to web pages, attachment to e-mail etc., picture size (number of pixels) is reduced.

- 1 Select [RESIZE] on the [PLAYBACK] Mode menu. (P55)
- 2 Press $\blacktriangle/\blacktriangledown$ to select [SINGLE] or [MULTI] and then press [MENU/SET].

3 Select the picture and size.

[SINGLE] setting

1 Press $\blacktriangle/\blacktriangleright$ to select the picture, and then press [MENU/SET].

2 Press $\blacktriangle/\blacktriangleright$ to select the size*, and then press [MENU/SET].

* Only the sizes to which the pictures can be resized is displayed.

[MULTI] setting

1 Press $\blacktriangle/\blacktriangledown$ to select the size, and then press [MENU/SET].

2 Press $\blacktriangle/\blacktriangledown/\blacktriangle/\blacktriangleright$ to select the picture, and then press [DISPLAY].

- Repeat this step for each picture, and press [MENU/SET] to set.

[SINGLE]

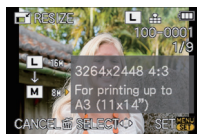
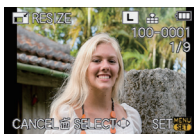

[MULTI]

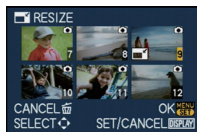
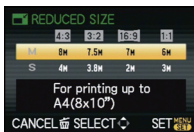

4 Press \blacktriangle to select [YES] and then press [MENU/SET].

- Press [HOME] to return to the menu screen. (The menu screen is automatically restored when [MULTI] is selected.)

Note

- You can set up to 100 pictures at one time in [MULTI].
- The picture quality of the resized picture will deteriorate.
- It may not be possible to resize pictures recorded with other equipment.
- Motion pictures, pictures stamped with [TEXT STAMP] and pictures taken with [RAW] or [RAW] cannot be resized.

[CROPPING]

You can enlarge and then crop the important part of the recorded picture.

- 1 Select [CROPPING] on the [PLAYBACK] Mode menu. (P55)
- 2 Press $\blacktriangle/\blacktriangledown$ to select [SINGLE] or [SINGLE IN BURST GROUP], and then press [MENU/SET].
 - When [SINGLE IN BURST GROUP] is selected, press $\blacktriangle/\blacktriangledown/\blacktriangleleft/\blacktriangleright$ to select burst picture group, and press [MENU/SET] to proceed to step 3.
- 3 Press $\blacktriangleleft/\blacktriangleright$ to select the picture, and then press [MENU/SET].
- 4 Use the rear dial and press $\blacktriangle/\blacktriangledown/\blacktriangleleft/\blacktriangleright$ to select the parts to be cropped.



Rear dial (right): Enlargement
Rear dial (left): Reduction

$\blacktriangle/\blacktriangledown/\blacktriangleleft/\blacktriangleright$: Move

- 5 Press [MENU/SET].
- 6 Press \blacktriangle to select [YES] and then press [MENU/SET].
 - Press [RETURN] to return to the menu screen.

Note

- Depending on the cut size, the picture size of the cropped picture may become smaller than that of the original picture.
- The picture quality of the cropped picture will deteriorate.
- It may not be possible to crop pictures recorded with other equipment.
- Motion pictures, pictures stamped with [TEXT STAMP] and pictures taken with [RAW], [RAW+], or [RAW] cannot be cropped.
- Information regarding the Face Recognition in the original picture will not be copied to images having undergone [CROPPING].

[ASPECT CONV.]

You can convert pictures taken with a [16:9] aspect ratio to a [3:2], a [4:3] or a [1:1] aspect ratio.

- 1 Select [ASPECT CONV.] on the [PLAYBACK] Mode menu. (P55)
- 2 Press $\blacktriangle/\blacktriangledown$ to select [SINGLE] or [SINGLE IN BURST GROUP], and then press [MENU/SET].
- 3 Press $\blacktriangle/\blacktriangledown$ to select [3:2], [4:3] or [1:1] and then press [MENU/SET].
 - When [SINGLE IN BURST GROUP] is selected, press $\blacktriangle/\blacktriangledown/\blacktriangleleft/\blacktriangleright$ to select burst picture group, and press [MENU/SET] to proceed to step 4.
- 4 Press $\blacktriangleleft/\blacktriangleright$ to select a picture taken with [16:9] aspect ratio, and then press [MENU/SET].
- 5 Press $\blacktriangleleft/\blacktriangleright$ to determine the horizontal position, and press [MENU/SET] to set.
 - Use $\blacktriangle/\blacktriangledown$ to set the frame position for pictures rotated vertically.
- 6 Press \blacktriangle to select [YES] and then press [MENU/SET].
 - Press [RETURN] to return to the menu screen.

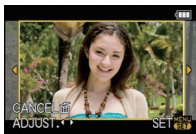





Note

- After converting the aspect ratio, the picture size may become larger than that of the original picture.
- You may not be able to convert pictures taken on other equipment.
- The [ASPECT CONV.] cannot be performed on the motion pictures, pictures stamped with [TEXT STAMP] and pictures taken with [RAW₁], [RAW₂] or [RAW].
- Information regarding the face recognition in the original picture will not be copied to images having undergone [ASPECT CONV.].

[ROTATE]/ [ROTATE DISP.]

This mode allows you to automatically display pictures vertically if they were recorded holding the camera vertically or rotate pictures manually in 90° steps.

Rotate (The picture is rotated manually)

- 1 Select [ROTATE] on the [PLAYBACK] Mode menu. (P55)**
 - The [ROTATE] function is disabled when [ROTATE DISP.] is set to [OFF].
- 2 Press /▶ to select the picture and then press [MENU/SET].**
- 3 Press ▲/▼ to select the direction to rotate the picture and then press [MENU/SET].**
 - : The picture rotates clockwise in steps of 90°.
 - : The picture rotates counter-clockwise in steps of 90°.
 - Press  to return to the menu screen.

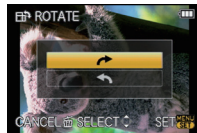

Rotate display (The picture is automatically rotated and displayed)

- 1 Select [ROTATE DISP.] on the [PLAYBACK] Mode menu. (P55)**
- 2 Press ▼ to select [ON] and then press [MENU/SET].**
 - The pictures are displayed without being rotated when you select [OFF].

Note

- [ROTATE DISP.] can only be used with the lens (P19) compatible with the Direction Detection Function (P36).
- When you play back pictures on a PC, they cannot be displayed in the rotated direction unless the OS or software is compatible with Exif. Exif is a file format for still pictures which allows recording information etc. to be added. It was established by "JEITA (Japan Electronics and Information Technology Industries Association)".
- It may not be possible to rotate pictures that have been recorded with other equipment.
- The display is not rotated during Multi Playback (P40).
- Pictures recorded with the camera upside down will not be displayed rotated.

★ [FAVORITE]

This can only be used when [FAVORITE FUNC.] (P62) in setup menu is set to [ON]. You can do the following if a mark has been added to pictures and they have been set as favourites.

- Play back the pictures set as favourites only as a slide show.
- Play back only the pictures set as favourites. ([FAVORITE PLAY])
- Delete all the pictures not set as favourites. ([ALL DELETE EXCEPT ★])
- For details about the icon display during Burst Picture Group playback, refer to P139.

1 Select [FAVORITE] on the [PLAYBACK] Mode menu. (P55)

2 Press ▲/▼ to select the item and then press [MENU/SET].

- When [SINGLE IN BURST GROUP] or [MULTI IN BURST GROUP] is selected, press ▲/▼/◀/▶ to select burst picture group, and press [MENU/SET] to proceed to step 3.
- When [CANCEL] is selected, see “Cancelling all the [FAVORITE] settings”.

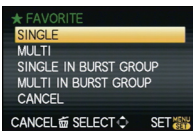

3 Select the picture, and then press [MENU/SET].

- [★] is displayed on pictures that are already registered as favourites.

When [MULTI] has been selected

- Repeat the above procedure.
- If [MENU/SET] is pressed again, the favourite setting is cancelled.
- Press [⏪] to return to the menu screen.

[SINGLE]



Press ◀/▶ to select the picture.

[MULTI]

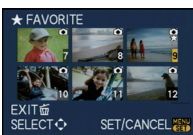

Press ▲/▼/◀/▶ to select the pictures.

■ Cancelling all the [FAVORITE] settings

1 Select [CANCEL] on the screen shown in step 2 and then press [MENU/SET].

2 Press ▲ to select [YES] and then press [MENU/SET].

- You cannot select [CANCEL] if not even one picture has been set as a favourite.
- [CANCEL] cannot be selected when in [PLAYBACK MODE].

Note

- You can set up to 999 pictures as favourites.
- When printing pictures at a photo printing store, [ALL DELETE EXCEPT ★] (P53) is useful so only the pictures you want to be printed remain on the card.
- You may not be able to set pictures taken with other equipment as favourites.
- The pictures that were taken with the [QUALITY] set to [RAW] cannot be set to [FAVORITE].

PRINT SET

DPOF "Digital Print Order Format" is a system that allows the user to select which pictures to print, how many copies of each picture to print and whether or not to print the recording date on the pictures when using a DPOF compatible photo printer or photo printing store. For details, ask at your photo printing store.

When you set [PRINT SET] for a burst picture group, the print setting for the number of prints will be applied to every picture in the group.

• For details about the icon display during Burst Picture Group playback, refer to P139.

1 Select [PRINT SET] on the [PLAYBACK] Mode menu. (P55)

2 Press ▲/▼ to select the item and then press [MENU/SET].

- When [SINGLE IN BURST GROUP] or [MULTI IN BURST GROUP] is selected, press ▲/▼/◀/▶ to select burst picture group, and press [MENU/SET] to proceed to step 3.
- When [CANCEL] is selected, see "Cancelling all the [PRINT SET] settings".

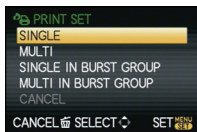

3 Select the picture, and then press [MENU/SET].

[SINGLE]

[MULTI]

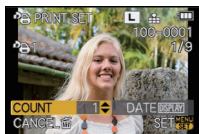

Press ◀/▶ to select the picture. Press ▲/▼/◀/▶ to select the pictures.

4 Press ▲/▼ to set the number of prints, and then press [MENU/SET] to set.

- When [MULTI] has been selected
 - repeat steps 3 and 4 for each picture.
 - [999+] is displayed on the screen, if the total number of prints you set for a burst picture group is more than 1000 pictures.
- Press [] to return to the menu screen.

■ Cancelling all the [PRINT SET] settings

1 Select [CANCEL] on the screen shown in step 2 and then press [MENU/SET].

2 Press ▲ to select [YES] and then press [MENU/SET].

• You cannot select [CANCEL] if not even one picture has been set for printing.

■ To print the date

After setting the number of prints, set/cancel printing with the recording date by pressing [DISPLAY].

- When you go to a photo printing store for digital printing, be sure to order the printing of the date additionally if required.
- Depending on the photo printing store or the printer, the date may not be printed even if you set to print the date. For further information, ask at your photo printing store or refer to the operating instructions for the printer.
- The date cannot be printed on pictures stamped with text.

Note

- The number of prints can be set from 0 to 999.
- With a printer supporting PictBridge, the date print settings of the printer may take precedence so check if this is the case.
- It may not be possible to use the print settings with other equipment. In this case, cancel all the settings, and reset the settings.
- If the file is not based on the DCF standard, the print setting cannot be set.
- [PRINT SET] cannot be set for motion pictures and pictures that were taken with the [QUALITY] set to [RAW].

ON [PROTECT]

You can set protection for pictures you do not want to be deleted by mistake.
 • For details about the icon display during Burst Picture Group playback, refer to P139.

1 Select [PROTECT] on the [PLAYBACK] Mode menu. (P55)**2 Press ▲/▼ to select the item and then press [MENU/SET].**

- When [SINGLE IN BURST GROUP] or [MULTI IN BURST GROUP] is selected, press ▲/▼/◀/▶ to select burst picture group, and press [MENU/SET] to proceed to step **3**.
- When [CANCEL] is selected, see “Cancelling all the [PROTECT] settings”.

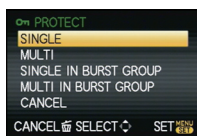
**3 Select the picture, and then press [MENU/SET].****When [MULTI] has been selected**

- Repeat these steps for each picture.
- The settings are cancelled when [MENU/SET] is pressed again.
- Press [⏪] to return to the menu screen.

[SINGLE]



Press ◀/▶ to select the picture.

[MULTI]

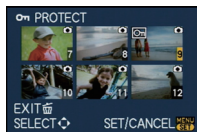

Press ▲/▼/◀/▶ to select the pictures.

■ Cancelling all the [PROTECT] settings**1 Select [CANCEL] on the screen shown in step 2 and then press [MENU/SET].****2 Press ▲ to select [YES] and then press [MENU/SET].**

• If you press [MENU/SET] while cancelling protection, the cancelling will stop halfway.

Note

- The protect setting may not be effective on other equipment.
- Even if you protect pictures on a card, they will be deleted if the card is formatted.
- Even if you do not protect pictures on a card, they cannot be deleted when the card's Write-Protect switch is set to [LOCK].

[FACE REC EDIT]

You can clear and replace all information relating to face recognition in selected images.

- 1** Select [FACE REC EDIT] on the [PLAYBACK] Mode menu. (P55)
- 2** Press ▲/▼ to select [REPLACE] or [DELETE] and then press [MENU/SET].
- 3** Press ◀/▶ to select the picture and then press [MENU/SET].
 - You cannot select pictures for which Face Recognition information has not been registered.
- 4** Press ◀/▶ to select the person and then press [MENU/SET].
 - [DELETE] → step **6**.
 - You cannot select a person who has not been registered.
- 5** Press ▲/▼/◀/▶ to select the person to replace and then press [MENU/SET].
- 6** Press ▲ to select [YES] and then press [MENU/SET].
 - Press [⏪] to return to the menu screen.



Note

- Cleared information regarding the [FACE RECOG.] cannot be restored.
- When all Face Recognition information in a picture has been cancelled, the picture will not be categorised using Face Recognition in [CATEGORY PLAY].

Enjoying 3D pictures

Taking 3D pictures

Attaching the 3D interchangeable lens (H-FT012; optional) to the camera allows you to take 3D pictures for extra impact. To view 3D pictures, a television that supports 3D is required.

3D picture



The image is an illustration.

1 Attach the 3D interchangeable lens to the camera. (P21)

2 Bring the subject into the frame and record by pressing the shutter button fully.

- Focusing is not required when recording 3D pictures.
- Still pictures recorded with the 3D interchangeable lens attached are saved in MPO format (3D).

To ensure that the 3D pictures can be safely viewed, pay attention to the following points when recording.

- Where possible, record with the unit in a horizontal state.
- Do not get too close to the subject [when the 3D interchangeable lens (H-FT012; optional) is used, record from a distance of at least 0.6 m (1.97 feet)].
- Be careful not to shake the camera while in a vehicle or walking.

Note

- **You cannot record 3D pictures in vertical orientation.**
- It is recommended to use a tripod or a flash to record steady pictures.
- When a distance to the subject is 0.6 m (1.97 feet) to approximately 1 m (3.28 feet), horizontal disparity becomes too great, and you may not see the 3D effect at the edges of the image.
- Up to approx. 460 3D pictures can be recorded on a 2 GB card. (When the aspect ratio is set to [4:3], and the quality is set to [3D].)
- Read the operating instructions of the 3D interchangeable lens for details.

■ Functions that cannot be used during 3D recording

When recording with the 3D interchangeable lens (H-FT012; optional), the following feature will be disabled:

(Recording functions)





- Auto Focus/Manual Focus operation
- Aperture setting
- Zoom operation
- Recording motion pictures*1
- [DYNAMIC ART] in My Colour Mode
- Monitor output (P159)

*1 The motion picture button, Creative Motion Picture Mode and the [MOTION PICTURE] Mode menu will be unavailable or unusable.



([REC] Mode menu)

- [PICTURE SIZE]^{*2}/[QUALITY]^{*3}/[STABILIZER]/[RED-EYE REMOVAL]/[I.RESOLUTION]/[I.DYNAMIC]/[EX. TELE CONV.]/[DIGITAL ZOOM]/[SH] of [BURST RATE]/[ASPECT BRACKET]



*2 The setting is fixed as shown below.

Aspect ratio	Picture size
	1920×1440 pixels
	1920×1280 pixels
	1920×1080 pixels
	1792×1792 pixels

*3 When attaching 3D interchangeable lens, the following icons are displayed.

- : MPO+Fine (Both MPO images and fine JPEG images are recorded simultaneously.)
- : MPO+Standard (Both MPO images and standard JPEG images are recorded simultaneously.)

([CUSTOM] menu)

- [AF/AE LOCK]/[PRE AF]/[DIRECT FOCUS AREA]/[FOCUS PRIORITY]/[SHUTTER AF]/[AF ASSIST LAMP]/[AF+MF]/[MF ASSIST]/[MF GUIDE]/[ BUTTON]/[ REC AREA]/[REMAINING DISP.]

Playing back 3D pictures

Connecting the camera to a 3D compatible television and playing back pictures taken in 3D allows you to enjoy 3D pictures for extra impact.

It is also possible to playback the recorded 3D pictures by inserting an SD card into the 3D compatible television with an SD card slot.

For the latest information on 3D compatible televisions and recorders that are capable of playing back 3D pictures recorded using the unit, see the support site below.

<http://panasonic.jp/support/global/cs/dsc/> (This Site is English only.)

Preparations: Set the [HDMI MODE] to [AUTO] or [1080i]. (P61)
Set the [3D PLAYBACK] to []. (P61)

Connect the unit to a 3D compatible television using the HDMI mini cable and display the playback screen. (P158)

- When [VIERA Link] (P61) is set to [ON] and the camera is connected to a TV supporting VIERA Link, input of the TV will be switched automatically and playback screen will be displayed. Refer to P159 for details.
- For the pictures recorded in 3D, [] will appear on the thumbnail display at playback.

■ Playback in 3D by selecting only the still pictures recorded in 3D

Select [3D PLAY] in [PLAYBACK MODE] in the [PLAYBACK] Mode menu. (P143)

■ Playback as a 3D slide show by selecting only the still pictures recorded in 3D

Select [3D] in [SLIDE SHOW] in the [PLAYBACK] Mode menu. (P141)

■ Switch the playback method for the still pictures recorded in 3D

1 Select the picture recorded in 3D.

2 Select [2D/3D SETTINGS] on the [PLAYBACK] Mode menu and then press ►.
(P55)

- Playback method will switch to 3D if it is playing back in 2D (conventional image), or it will switch to 2D if it is playing back in 3D.
- If you feel tired, uncomfortable or otherwise strange when playing back pictures recorded in 3D, set to 2D.

■ Functions that cannot be set/do not work with 3D pictures

- [HIGHLIGHT] in the [CUSTOM] menu*
- Playback Zoom*
- Deleting pictures*
- Editing functions of [PLAYBACK] Mode menu ([TITLE EDIT]/[TEXT STAMP]/[VIDEO DIVIDE]/[RESIZE]/[CROPPING]/[ASPECT CONV.]/[ROTATE.]/[ROTATE DISP.]/[FAVORITE]*/[PRINT SET]*/[PROTECT]*/[FACE REC EDIT]*)

* Can be used when displayed in 2D.



Note

- When a picture recorded in 3D is displayed on the LCD monitor/viewfinder of this unit, it is played back in 2D (conventional image).
- A black screen is displayed for a few seconds when switching back and forth playback of 3D pictures and 2D pictures.
- When you select a 3D picture thumbnail, it may take a few seconds for playback to start. After playback, the thumbnail display may take a few seconds to reappear.
- When viewing 3D pictures, your eyes may become tired if you are too close to the television screen.
- If your television does not switch to a 3D picture, make the necessary settings on the TV. (For details, refer to the operating instructions of the TV.)

Saving 3D pictures

You can save 3D pictures using a recorder or a computer.

■ Dubbing with a recorder

3D pictures will be recorded in MPO format when copied with the 3D compatible recorder.

- When the copied pictures do not playback in 3D, perform the necessary setup on the television. (For details, refer to the operating instruction of the television.)
- **Note that the equipment described may not be available in certain countries and regions.**

Copying of the still pictures recorded in 3D

Check the latest information about the equipment that can copy on the following website.

<http://panasonic.jp/support/global/cs/dsc/> (This Site is English only.)

■ Copying to a PC

- For details, refer to "Copying to a PC using "PHOTOfunSTUDIO 6.0 BD Edition"" on P163.

Playing Back Pictures on a TV Screen

Playing back pictures using the AV cable (supplied)

Preparations: Set the [TV ASPECT]. (P60)
Turn this unit and the TV off.

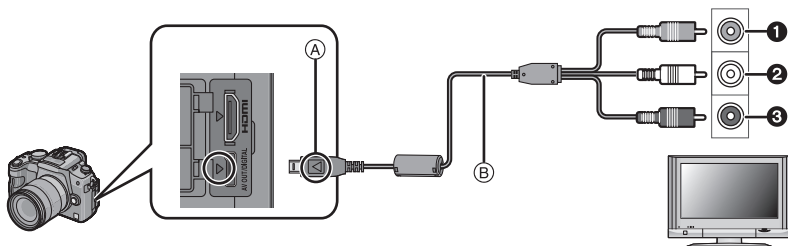

- ❶ Yellow: to the video input socket
- ❷ White: to the audio input socket
- ❸ Red: to the audio input socket
- Ⓐ Align the marks, and insert.
- Ⓑ AV cable (supplied)
- Check the directions of the connectors, and plug them straight in or unplug them straight out. (Otherwise the connectors may be bent out of shape which may cause malfunction.)

- 1** Connect the AV cable ❷ (supplied) to the video input and the audio input sockets on the TV.
- 2** Connect the AV cable to the [AV OUT] socket on the camera.
- 3** Turn the TV on and select external input.
- 4** Turn the camera on and then press [▶].

Note

- Depending on the [ASPECT RATIO], black bands may be displayed on the top and bottom or the left and right of the pictures.
- Do not use any other AV cables except the supplied one.
- Read the operating instructions for the TV.
- When you play back a picture vertically, it may be blurry.
- You can view pictures on TVs in other countries (regions) which use the NTSC or PAL system when you set [VIDEO OUT] in the [SETUP] menu.
- Audio will be played back as stereo (2ch).
- The viewfinder cannot be displayed when connected with a AV cable.
- Change the screen mode on your TV if the picture is displayed with the top or bottom cut off.
- AV output is disabled when recording.

Playing back pictures on a TV with an SD Memory Card slot

The recorded still pictures can be played back on a TV with an SD Memory Card slot.

Note

- Depending on the TV model, pictures may not be displayed on the full screen.
- Motion pictures recorded with [AVCHD] can be played back on Panasonic TVs (VIERA) with the AVCHD logo mark. In all other cases, connect the camera to the TV using the AV cable (supplied) and play back the motion picture.
- SDHC Memory Cards cannot be played back unless it is a TV compatible with SDHC Memory Cards or SDXC Memory Cards.
- SDXC Memory Cards cannot be played back unless it is a TV compatible with SDXC Memory Cards.

Playing back on the TV with HDMI socket

You can enjoy high quality pictures and motion pictures on the TV by connecting the camera with the HDMI compatible high-definition TV using HDMI mini cable (optional).

Preparations: Check the [HDMI MODE]. (P61)
Turn this unit and the TV off.

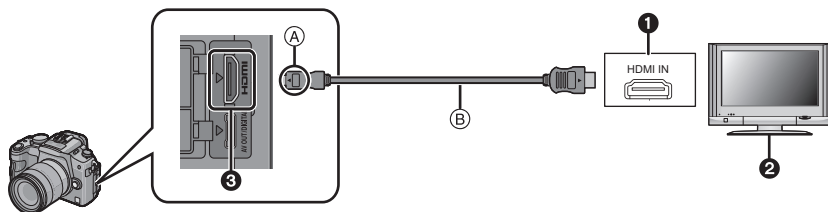

① HDMI socket

② TV with HDMI socket

③ HDMI mini (C type)

Ⓐ Align the marks, and insert.

Ⓑ HDMI mini cable (optional)

- Check the direction of the terminals and plug in/out straight holding onto the plug. (It may result in malfunction if it is plugged in obliquely or in the wrong direction.)

1 Connect the HDMI mini cable Ⓑ (optional) to the HDMI input socket on the TV.

2 Connect the HDMI mini cable to the [HDMI] socket on the camera.

3 Turn the TV on and switch to HDMI input.

4 Turn the camera on and then press [▶].

- When [VIERA Link] (P61) is set to [ON] and the camera is connected to a TV supporting VIERA Link, input of the TV will be switched automatically and playback screen will be displayed (P159).

Note

- Depending on the [ASPECT RATIO], bands may be displayed on the top and bottom or the left and right of the pictures.
- Always use a genuine Panasonic HDMI mini cable (RP-CDHM15, RP-CDHM30; optional). Part numbers: RP-CDHM15 (1.5 m) (5 feet), RP-CDHM30 (3.0 m) (10 feet)
- Output from the HDMI mini cable has priority when both AV cable and HDMI mini cable are connected.
- The connection with the USB connection cable will take priority when you connect the USB connection cable simultaneously with the HDMI mini cable.
- When pictures are displayed, they may not be displayed properly depending on the type of TV.
- Read the operating instructions for the TV.
- Audio will be played back as stereo (2ch).
- During [24P CINEMA] and [VARIABLE MOVIE MODE] playback, please set [HDMI MODE] to [AUTO]. For settings other than [AUTO], it cannot output at 24 frames/second.

■ Monitoring camera images on the TV

With HDMI output, you can monitor full high-definition quality (1920×1080 pixels) AVCHD motion pictures on the TV while recording.

Note

- Some functions are unavailable during monitoring.
- Audio is not output from the TV.
- Up to 20 still pictures can be recorded during recording of the motion picture.

Playback using VIERA Link (HDMI) (HDAVI Control™)

What is the VIERA Link?

- This function allows you to use your remote control for the Panasonic TV for easy operations when this unit has been connected to a VIERA Link compatible device using a HDMI mini cable (optional) for automatic linked operations. (Not all operations are possible.)
- VIERA Link is a unique Panasonic function built on a HDMI control function using the standard HDMI CEC (Consumer Electronics Control) specification. Linked operations with HDMI CEC compatible devices made by other companies are not guaranteed. When using devices made by other companies that are compatible with VIERA Link, refer to the operating instructions for the respective devices.
- This unit is compatible with VIERA Link Ver.5. VIERA Link Ver.5 is the newest Panasonic version and is also compatible with existing Panasonic VIERA Link devices. (As of December 2009)

Preparations: Set the [VIERA Link] to [ON]. (P61)

- 1 Connect this unit to a Panasonic TV compatible with VIERA Link with a HDMI mini cable (optional) (P158).**
- 2 Turn the camera on and then press [▶].**
- 3 Operate with the remote control for the TV.**

Panasonic TV compatible with VIERA Link

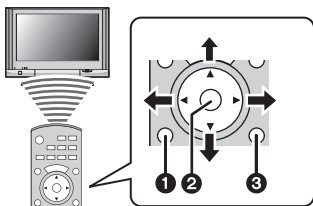



- ❶ [OPTION]
- ❷ [OK]
- ❸ [RETURN]

* The shape of the remote control varies depending on the region. Operate following the TV guide displayed on screen.

■ Usable functions

Operate with the remote control for the TV.

<p>Multi Playback</p> 	<p>This is displayed initially when using the VIERA Link.</p> <p>▲/▼/◀/▶: Select the image. [OK]: Go to one screen display. Pictures in Burst Picture Group are played back with Multi Playback. (When Burst Picture Group is selected)</p> <p>Red button: Switch the types of data to play back. [OPTION]: Display the Playback Mode selection screen.</p> <ul style="list-style-type: none"> • The type of data for playback changes in the order of [ALL] → [📷] → [👤] → [📺] → [3D] → [ALL]. • Either the [NORMAL PLAY], [SLIDE SHOW], [CATEGORY PLAY], [FAVORITE PLAY] or the [CALENDAR] can be selected in the Playback Mode selection screen when [ALL] is selected.
<p>One screen display</p> 	<p>Select the image while in Multi Playback, and then press [OK].</p> <p>◀/▶: Go to previous/next image. ▲: 2D/3D switch*¹ ▼: Return to Multi Playback. [OK]: Playback the motion picture (when motion picture is selected). Playback burst pictures (when burst picture is selected).</p> <p>Red button: Start the Slide Show. [OPTION]: Slide show settings*², display the recording information switch</p> <ul style="list-style-type: none"> • During Motion Picture Playback/Burst Picture Playback, ◀/▶ will fast rewind/fast forward, and ▼ will end the playback.

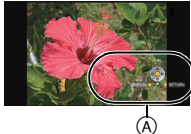
<p>Slide show</p>  <p style="text-align: center;">(A)</p>	<p>Press Red button during one screen display.</p> <p>◀/▶: Go to previous/next image (when Slide Show is paused/when motion picture is played back).</p> <p>▼: Finish the Slide Show and return to one screen display.</p> <p>[OK]: Pause.</p> <p>[OPTION]: Go to Slide Show setting screen.*2</p> <p>* To playback the audio of the motion pictures, set the [SOUND] in the Slide Show setting screen to [AUTO] or [AUDIO].</p>
--------------------------------------------------------------------------------------------------------------------------------------------	-----------------------------------------------------------------------------------------------------------------------------------------------------------------------------------------------------------------------------------------------------------------------------------------------------------------------------------------------------------------------------------------------------------------------------------------

(A) Operation icon

*1 This is displayed only when 3D playback is possible.

*2 This is not displayed during 3D playback.

Note

- Operation icons are hidden by pressing [RETURN], or if no operation is performed for a while when the operation icons are displayed. Operation icons are displayed when one of the following buttons is pressed while the operation icons are not displayed.
– ▲/▼/◀/▶, [OK], [OPTION], [RETURN], Red button, Green button, Yellow button
- It is recommended to connect this unit to an HDMI terminal other than the HDMI1 if there are 2 or more HDMI input terminals on the TV.
- When the [VIERA Link] (P61) of this unit is set to [ON], operation using the button on this unit will be limited.
- VIERA Link must be activated on the connected TV. (Read the operating instructions of the TV for how to set etc.)
- If you are not using VIERA Link, set [VIERA Link] (P61) to [OFF].

Other linked operations

Turning the power off:

If you use the remote control for the TV to turn off the power, the power on this unit also turns off.

Automatic input switching:

- If you connect with a HDMI mini cable and then turn on the power on this unit, and then press [▶], the input channel on the TV automatically switches to this unit's screen. If the TV's power is in standby status, it will turn on automatically (if [Set] has been selected for the TV's [Power on link] setting).
- Depending on the HDMI terminal on the TV, the input channel may not switch automatically. In this case, use the remote control for the TV to switch the input channel. (For details on how to switch input, please read the operating instructions for the TV.)
- If VIERA Link does not work properly, refer to page 192.

Note

- If you are unsure whether or not the TV you are using are compatible with VIERA Link, read the operating instructions for the TV.
- Available linked operations between this unit and a Panasonic TV is different depending on the types of Panasonic TVs even if they are compatible with VIERA Link. Refer to the operating instructions of the TV for the operations that support on the TV.
- Operation is not possible with a cable that is not based on the HDMI standard.
Always use a genuine Panasonic HDMI mini cable (RP-CDHM15, RP-CDHM30; optional).
Part numbers: RP-CDHM15 (1.5 m) (5 feet), RP-CDHM30 (3.0 m) (10 feet)
- VIERA Link will not work even if you connect the HDMI mini cable while the unit is connected to the PC or the printer.
- [HDMI MODE] (P61) for this unit is determined automatically when the VIERA Link is operating.

Saving the Recorded Still Pictures and Motion Pictures

Methods to export still pictures and motion pictures to other devices will vary depending on the file format. (JPEG, RAW, MPO, AVCHD, or Motion JPEG). Here are a few suggestions.

■ Copy by inserting the SD card into the recorder

File formats that can be used: [JPEG], [AVCHD]

It is possible to copy onto Blu-ray disk, DVD disk, or hard disk by inserting an SD card with still pictures and motion pictures recorded by this unit into a Panasonic Blu-ray Disk Recorder or DVD Recorder.

Check the latest information about the equipment that can copy directly by inserting the SD card recorded by this unit, and equipment that is compatible with high definition (AVCHD) on the following website.

<http://panasonic.jp/support/global/cs/dsc/> (This Site is English only.)

- See the instruction manual for the recorder about the details of copying and playing back.
- **Note that the equipment described may not be available in certain countries and regions.**



■ Copy the playback image using an AV cable

File formats that can be used: [AVCHD], [Motion JPEG]

Copy images played back with this unit to Blu-ray disk, DVD disc, hard disk, or video using a Blu-ray Disk Recorder, DVD recorder, or video.

This can be played back with equipment that is not compatible with high-definition (AVCHD), so it is convenient for distributing copies. Image will be standard quality instead of high-definition at this time.

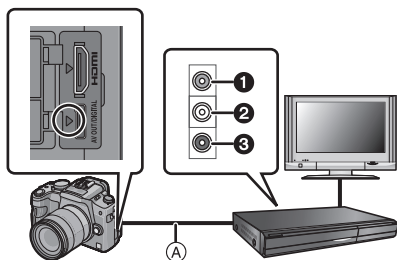

- ❶ Yellow: to the video input socket
- ❷ White: to the audio input socket
- ❸ Red: to the audio input socket
- Ⓐ AV cable (supplied)

- 1** Connect this unit with the recording equipment with an AV cable (supplied).
- 2** Start the playback of this unit.
- 3** Start the recording on the recording equipment.

- When ending the recording (copying), stop the playback on this unit after stopping the recording in recording equipment.

Note

- When you play back motion pictures on 4:3 aspect ratio TV, you must set [TV ASPECT] (P60) on this unit to [4:3] before starting a copy. The image will be vertically long if you play back motion pictures copied with [16:9] setting on a [4:3] aspect TV.
- Do not use any other AV cables except the supplied one.
- It is recommended to turn off the display of the screen by pressing the [DISPLAY] on the camera while copying. (P40)
- See the instruction manual for the recording equipment about the details of copying and playing back.

■ Copying to a PC using “PHOTOfunSTUDIO 6.0 BD Edition”

File formats that can be used: [JPEG], [RAW], [MPO], [AVCHD], [Motion JPEG]
 It is possible to acquire still pictures and motion pictures recorded in [AVCHD] or [MOTION JPEG] formats, or create conventional standard quality DVD video from the motion picture that was recorded as [AVCHD], using “PHOTOfunSTUDIO 6.0 BD Edition” in the CD-ROM (supplied).

Also, you can write images to DVD, combine multiple pictures to create a single panorama picture, or create a slide show by adding audio and/or music. These pictures can then be stored onto a DVD.

**1 Install “PHOTOfunSTUDIO 6.0 BD Edition” to the PC.**

- Read the separate operating instructions for the supplied software for more information about the software in the CD-ROM (supplied) and how to install it.

2 Connect camera to PC.

- For details on connecting, refer to “Connecting to a PC” (P164).

3 Copy the images to a PC using “PHOTOfunSTUDIO 6.0 BD Edition”.

- For details, refer to the operating instructions of “PHOTOfunSTUDIO 6.0 BD Edition” (PDF).

Note

- You will not be able to playback the acquired [AVCHD] motion pictures when the files or folders related to the motion pictures are deleted, modified, or moved using Windows Explorer or similar, so make sure to acquire the [AVCHD] motion pictures using “PHOTOfunSTUDIO 6.0 BD Edition”.

Connecting to a PC

You can acquire recorded pictures to a PC by connecting the camera and the PC.

- Some PCs can read directly from the card removed from the camera. For details, refer to the operating instructions of your PC.
- **If the computer being used does not support SDXC Memory Cards, a message prompting you to format may appear. (Doing so will cause recorded images to be erased so do not choose to format.)**

If the card is not recognised, please refer to the below support site.

<http://panasonic.net/avc/sdcard/information/SDXC.html>

- You can easily print out or mail the pictures you have imported. Use of the “PHOTOfunSTUDIO 6.0 BD Edition” bundled software on the CD-ROM (supplied) is a convenient way of doing this.
- Read the separate operating instructions for the supplied software for more information about the software in the CD-ROM (supplied) and how to install it.

Acquiring of still pictures and [MOTION JPEG] motion pictures (other than [AVCHD] motion pictures)

Preparations: Turn the LCD monitor so the LCD will show out.
Turn on the camera and the PC.

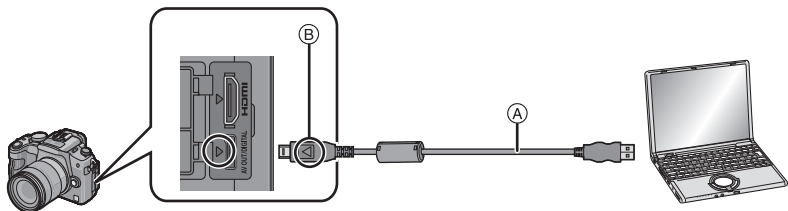

(A) USB connection cable (supplied)

- Check the directions of the connectors, and plug them straight in or unplug them straight out. (Otherwise the connectors may be bent out of shape which may cause malfunction.)

(B) Align the marks, and insert.

- Use a battery with sufficient battery power or the AC adaptor (DMW-AC8E; optional) and DC coupler (DMW-DCC8; optional). If the remaining battery power becomes low while the camera and the PC are communicating, the status indicator blinks and the alarm beeps. Refer to “Disconnecting the USB connection cable safely” (P165) before disconnecting the USB connection cable. Otherwise, data may be destroyed.

1 Connect the camera to a PC via the USB connection cable (A) (supplied).

- **Do not use any other USB connection cables except the supplied one. Use of cables other than the supplied USB connection cable may cause malfunction.**

2 Press ▲/▼ to select [PC], and then press [MENU/SET].

- If [USB MODE] (P60) is set to [PC] in the [SETUP] menu in advance, the camera will be automatically connected to the PC without displaying the [USB MODE] selection screen. Since there is no need to set this each time you connect to the PC, it is convenient.
- When the camera has been connected to the PC with [USB MODE] set to [PictBridge(PTP)], a message may appear on the PC's screen. Select [Cancel] to close the screen, and disconnect the camera from the PC. Then set [USB MODE] to [PC] again.

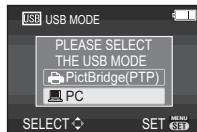

3 Double-click on [Removable Disk] in [My Computer].

- When using a Macintosh, the drive is displayed on the desktop. ("LUMIX", "NO_NAME" or "Untitled" is displayed.)

4 Double-click [DCIM] folder.

5 Using a drag-and-drop operation, move the pictures you want to acquire or the folder storing those pictures to any different folder on the PC.

- Data from the PC can not be written to the camera using the USB connection cable.

■ Disconnecting the USB connection cable safely

- Proceed with the hardware removal using "Safely Remove Hardware" on the task tray of the PC. If the icon is not displayed, check that [ACCESS] is not displayed on the LCD monitor of the digital camera before removing the hardware.



Note

- Turn the camera off before connecting or disconnecting the AC adaptor (DMW-AC8E; optional).
- Before inserting or removing a card, turn the camera off and disconnect the USB connection cable. Otherwise, data may be destroyed.

■ Viewing the contents of the card using the PC (folder composition)

Folders and images processed in the PC cannot be played back on the camera. It is recommended to use the "PHOTOfunSTUDIO 6.0 BD Edition" bundled software on the CD-ROM (supplied) when you write the image from PC to a card.

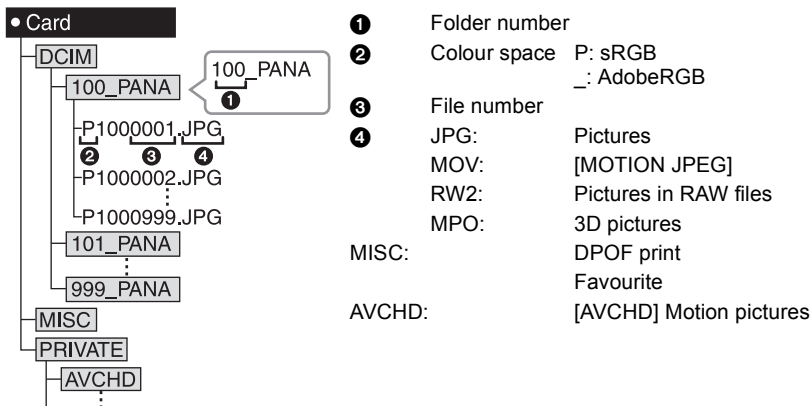

A new folder is created when pictures are taken in the following situations.

- After [NO.RESET] (P63) in the [SETUP] menu has been executed
- When a card containing a folder with the same folder number has been inserted (Such as when pictures were taken using another make of camera)
- When there is a picture with file number 999 inside the folder

■ Connection in the PTP Mode (Windows[®] XP, Windows Vista[®], Windows[®] 7 and Mac OS X only)

Set [USB MODE] to [PictBridge(PTP)].

Data can now be read only from the card into the PC.

- When there are 1000 or more pictures on a card, the pictures may not be imported in the PTP mode.
- [AVCHD] motion picture cannot be played back in PTP Mode.

Printing the Pictures

If you connect the camera to a printer supporting PictBridge, you can select the pictures to be printed out and instruct that printing be started on the camera's LCD monitor.

- Burst pictures taken with burst speed set to [SH] will be displayed as a list, and not as a group.
- Some printers can print directly from the card removed from the camera. For details, refer to the operating instructions of your printer.

Preparations: Turn on the camera and the printer.

Perform the print quality and other settings at the printer before printing the pictures.

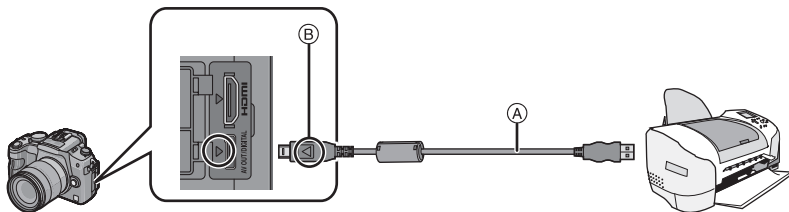

(A) USB connection cable (supplied)

- Check the directions of the connectors, and plug them straight in or unplug them straight out. (Otherwise the connectors may be bent out of shape which may cause malfunction.)
- (B) Align the marks, and insert.
- Use a battery with sufficient battery power or the AC adaptor (DMW-AC8E; optional) and DC coupler (DMW-DCC8; optional). If the remaining battery power becomes low while the camera and the printer are connected, the status indicator blinks and the alarm beeps. If this happens during printing, stop printing at once. If not printing, disconnect the USB connection cable.

1 Connect the camera to a printer via the USB connection cable (A) (supplied).

- When the camera is connected to the printer, the cable disconnect prohibit icon [🚫] appears. Do not disconnect the USB cable while [🚫] is displayed.

2 Press ▲/▼ to select [PictBridge(PTP)], and then press [MENU/SET].

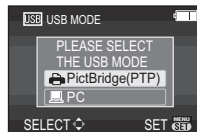

Note

- Do not use any other USB connection cables except the supplied one. Use of cables other than the supplied USB connection cable may cause malfunction.
- Turn the camera off before connecting or disconnecting the AC adaptor (DMW-AC8E; optional).
- Before inserting or removing a card, turn the camera off, and disconnect the USB connection cable.
- Motion pictures recorded cannot be printed out.

Selecting a single picture and printing it

1 Press ◀/▶ to select the picture and then press [MENU/SET].

- The message disappears in about 2 seconds.

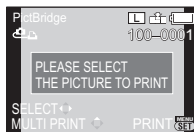

2 Press ▲ to select [PRINT START] and then press [MENU/SET].

- Refer to P169 for the items which can be set before starting to print the pictures.
- Press [MENU/SET] to cancel printing halfway.
- Disconnect the USB connection cable after printing.

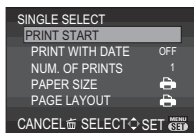

Selecting multiple pictures and printing them

1 Press ▲.

2 Press ▲/▼ to select an item and then press [MENU/SET].

- If the print check screen has appeared, select [YES], and print the pictures.

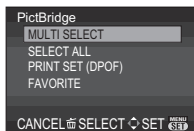

Item	Description of settings
[MULTI SELECT]	Multiple pictures are printed at one time. <ul style="list-style-type: none"> Press ▲/▼/◀/▶ to select the pictures, and then when [DISPLAY] is pressed, [] appears on the pictures to be printed. (When [DISPLAY] is pressed again, the setting is cancelled.) After the pictures have been selected, press [MENU/SET].
[SELECT ALL]	Prints all the stored pictures.
[PRINT SET (DPOF)]	Prints the pictures set in [PRINT SET] only. (P151)
[FAVORITE]*	Prints the pictures set as favourites only. (P150)

* Only when [FAVORITE FUNC.] is at [ON] and when there are pictures set as favourites. (P150)

3 Press ▲ to select [PRINT START] and then press [MENU/SET].

- Refer to P169 for the items which can be set before starting to print the pictures.
- Press [MENU/SET] to cancel printing.
- Disconnect the USB connection cable after printing.

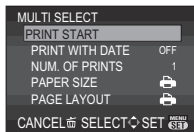

Print Settings

Select and set the items both on the screen in step **2** of the “Selecting a single picture and printing it” and in step **3** of the “Selecting multiple pictures and printing them” procedures.

- When you want to print pictures on a paper size or a layout which is not supported by the camera, set [PAPER SIZE] or [PAGE LAYOUT] to [] and then set the paper size or the layout on the printer. (For details, refer to the operating instructions of the printer.)
- When [PRINT SET (DPOF)] has been selected, the [PRINT WITH DATE] and [NUM. OF PRINTS] items are not displayed.

■ [PRINT WITH DATE]

Item	Description of settings
[OFF]	Date is not printed.
[ON]	Date is printed.

- If the printer does not support date printing, the date cannot be printed on the picture.
- Since the printer's settings may take precedence over the print with date setting, check the printer's print with date setting as well.
- When printing images with a text stamp, please remember to set print with date to [OFF] or the date will print on top.
- In some printers, the picture date for pictures taken with the aspect ratio set to [] will be printed vertically.

Note

When asking the photo shop to print the pictures

- By stamping the date using [TEXT STAMP] (P145) or setting date printing at the time of the [PRINT SET] (P151) setting before going to a photo shop, the dates can be printed at the photo shop.

■ [NUM. OF PRINTS]

You can set the number of prints up to 999.





- You can also use the rear dial to set.

■ [PAPER SIZE]

Item	Description of settings
	Settings on the printer are prioritised.
[L/3.5"×5"]	89 mm×127 mm
[2L/5"×7"]	127 mm×178 mm
[POSTCARD]	100 mm×148 mm
[16:9]	101.6 mm×180.6 mm
[A4]	210 mm×297 mm
[A3]	297 mm×420 mm
[10×15cm]	100 mm×150 mm
[4"×6"]	101.6 mm×152.4 mm
[8"×10"]	203.2 mm×254 mm
[LETTER]	216 mm×279.4 mm
[CARD SIZE]	54 mm×85.6 mm

• Paper sizes not supported by the printer will not be displayed.

■ [PAGE LAYOUT] (Layouts for printing that can be set with this unit)

Item	Description of settings
	Settings on the printer are prioritised.
	1 picture with no frame on 1 page
	1 picture with a frame on 1 page
	2 pictures on 1 page
	4 pictures on 1 page

• An item cannot be selected if the printer does not support the page layout.

■ Layout printing

When printing a picture several times on 1 sheet of paper

For example, if you want to print the same picture 4 times on 1 sheet of paper, set [PAGE LAYOUT] to  and then set [NUM. OF PRINTS] to 4 for the picture that you want to print.

When printing different pictures on 1 sheet of paper

For example, if you want to print 4 different pictures on 1 sheet of paper, set [PAGE LAYOUT] to  and then set [NUM. OF PRINTS] to 1 for each of the 4 pictures.

Note

- The camera is receiving an error message from the printer when the  indication lights orange during printing. After finishing printing, make sure there are no problems with the printer.
- If the number of prints is high, the pictures may be printed several times. In this case, the remaining number of prints indicated may differ from the number set.
- When the pictures in RAW files are to be printed, the JPEG pictures recorded simultaneously by the camera will be printed. If JPEG pictures do not exist, RAW file pictures cannot be printed.

Optional accessories

External Flash (optional)

After attaching the external flash (DMW-FL220, DMW-FL360, DMW-FL500; optional), the effective range will be increased when compared to the camera's built-in flash.

Preparations:

- Turn off the camera and close the built-in flash.

■ Using the dedicated flash (DMW-FL220; optional)

1 Attach the dedicated flash to the hot shoe and then turn on the camera and the dedicated flash.

2 Select [FLASH] on the [REC] Mode menu. (P55)

3 Press ▲/▼ to select the mode and then press [MENU/SET].

- While the external flash is connected, the following icons are displayed.

⚡: External flash Forced ON

⚡S: External flash Slow Sync.

■ When using other commercially available external flashes without communication functions with the camera (DMC-GH2)

- It is necessary to set the exposure on the external flash. If you want to use the external flash in Auto Mode, use an external flash that allows you to set the aperture value and the ISO sensitivity to match the settings on the camera.
- Set to Aperture-Priority AE Mode or Manual Exposure Mode on the camera and then set the same aperture value and ISO sensitivity on the external flash. (The exposure cannot be compensated adequately due to the change on the aperture value in Shutter-Priority AE Mode and the external flash cannot control the light adequately in Programme AE Mode because the aperture value cannot be fixed.)

Note

- You can set the aperture value, the shutter speed and the ISO sensitivity on the camera even when attaching the external flash.
- Some commercial external flashes have synchro terminals with high-voltage or reversed polarity. Using such extra flashes may cause a malfunction or the camera may not operate normally.
- If you use commercially available external flashes with communication functions other than the dedicated one, they may not operate normally or they may be damaged. Do not use them.
- Even if the external flash is turned off, the camera may enter the external flash mode when the external flash is attached. When you are not using the external flash, detach it.
- Do not open the built-in flash when an external flash is attached.
- The camera will become unstable when attaching the external flash, it is recommended to use a tripod when taking picture.
- Detach the external flash when carrying the camera.
- When attaching the external flash, do not hold only the external flash because it may detach from the camera.

- If you use the external flash when the White Balance is set to [$\frac{1}{400}$] finely adjust the White Balance depending on the picture quality. (P90)
- If you take pictures close to the subject in Wide, the vignetting effect may appear on the bottom of the recorded picture.
- The external flash cannot be used while the stereo microphone (DMW-MS1; optional) is in use.
- Read the operating instructions of the external flash for details.

Protector/Filter (optional)

The MC protector (optional) is a transparent filter which affects neither the colours nor the amount of light, so it can always be used to protect the camera's lens.

The ND filter (optional) reduces the amount of light to approximately 1/8th (equal to adjusting the aperture value 3 increments) without affecting the colour balance.

PL filter (optional) will suppress the reflected light from a metal or non spherical surfaces (flat non-metallic surfaces, water vapour or invisible particles in the air), making it possible to take a picture with enhanced contrast.



Note

- **MC**="Multi-coated"
ND="Neutral Density"
- Do not attach multiple filters at the same time.
- You can attach the lens cap or the lens hood when the filter is attached.
- Accessories other than filters, such as conversion lenses, cannot be mounted. It may cause malfunction.
- It is recommended to use the MC protector (DMW-LMCH62; optional), the ND filter (DMW-LND62; optional), or the PL filter (DMW-LPL62; optional) with the lenses supplied in DMC-GH2H.
- It is recommended to use the MC protector (DMW-LMC52; optional), the ND filter (DMW-LND52; optional), or the PL filter (DMW-LPL52; optional) with the lens supplied in DMC-GH2K.
- Refer to the instructions for each filter for details.

Remote Shutter (optional)

If you use the remote shutter (DMW-RSL1; optional), you can avoid jitter (camera shake) when using a tripod and you can keep the shutter pressed fully when taking pictures with [B] (Bulb) or Burst Mode. The remote shutter works similar to the shutter button on the camera.



Note

- Always use a genuine Panasonic remote shutter (DMW-RSL1; optional).
- You cannot operate the camera with the remote shutter in the following cases.
 - When the Sleep Mode is cancelled
- Record with Creative Motion Picture Mode (P106) when using for motion picture recording. Motion picture recording can be started/stopped with the remote shutter.
- The remote shutter cannot be used while the stereo microphone (DMW-MS1; optional) is in use.
- Read the operating instructions of the remote shutter for details.

External Microphone (optional)

If you use the stereo microphone (DMW-MS1; optional), you can switch to either stereo or monaural sound recording.

It is also possible to reduce the wind noise efficiently by switching the [WIND CUT OFF/ON] switch to [ON].

Battery Check Lamp [BATTERY]

- When the Off/On Mode Selector Switch is changed from [OFF] to [MONO] or [STEREO], the Battery Check Lamp [BATTERY] will light temporarily if there is still plenty of power in the battery. If the Battery Check Lamp [BATTERY] does not light temporarily, replace the battery with a new one.



Note

- While the external microphone is connected, [🔊] is displayed on the screen.
- When the external microphone is connected, [MIC LEVEL DISP.] (P129) is automatically set to [ON], and the mic level is displayed on the screen.
- When attaching the stereo microphone, do not hold only the stereo microphone because it may detach from the camera.
- Set the wind noise reduction only on the stereo microphone side.
- Do not open the built-in flash when the stereo microphone is attached.
- The stereo microphone cannot be used while the external flash (optional) is in use.
- The stereo microphone cannot be used while the remote shutter (DMW-RSL1; optional) is in use.
- Read the operating instructions of the stereo microphone for details.

AC adaptor (optional)/DC coupler (optional)

By connecting the AC adaptor (DMW-AC8E; optional) and the DC coupler (DMW-DCC8; optional), and then plugging them into an electrical socket, you can connect this unit to a PC or printer and use without worrying about the capacity of the battery.



Note

- Always use a genuine Panasonic AC adaptor (DMW-AC8E; optional).
- Always use a genuine Panasonic DC coupler (DMW-DCC8; optional).
- When using an AC adaptor, use the AC mains lead supplied with the AC adaptor.
- Also read the operating instructions for the AC adaptor and DC coupler.

LCD Monitor Display/Viewfinder Display

- The following images are examples of when the display screen is set to [] (LCD monitor style) in the LCD monitor.

■ In recording

Recording in Programme AE Mode [] (Initial setting)

- Flash Mode (P69)
- Film Mode (P118)
- Optical Image Stabilizer (P74)/
[]: Jitter alert (P75)
- []: Single*¹ (P35)
[]: Burst (P77)
[]: Auto Bracket (P79)
[]: Self-timer (P81)
- REC MODE (when recording motion pictures) (P127)/Recording quality (P127)
- Picture size (P120)
- Quality (P121)
- Intelligent Dynamic Range Control (P124)
- Intelligent Resolution (P123)
- Battery indication (P26)
- Card (P29) (displayed only during recording)
- Recording state (Flashes red./ Focus (P34) (Lights green.))
- Touch Quick Menu*² (P56)
- Touch Shutter*² (P38)
- Dial operation guide (P135)/ Elapsed recording time (P44)
- Number of recordable pictures*³ (P30)
- White Balance (P88)
- ISO sensitivity (P91)
- Exposure compensation value (P76)/ Manual exposure assistance (P94)
- Shutter speed (P35)
- Aperture value (P35)
- Recording Mode (P32)
- Metering Mode (P122)
- AF Mode (P82)
- Focus Mode (P34)
- Exposure meter (P133)
- AF area (P34, 82)
- Picture priorities (P108)

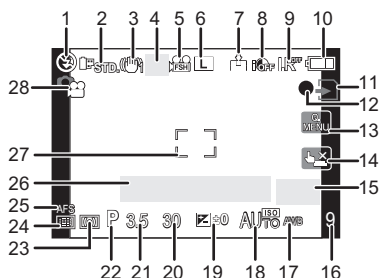

■ In recording (after settings)

- 29 Flash output adjustment (P74)
- 30 2nd curtain synchro (P123)
- 31 Digital Zoom (P67)
- 32 FRAME RATE (P107)
- 33 Extra Tele Conversion (when recording motion pictures) (P67)
- 34 Extra Tele Conversion (when taking still pictures) (P67)
- 35 Histogram (P66)
- 36 Travel date (P115)
- AF tracking operation (P49, 83)
- 37 Available recording time*³ (P30): R8m30s*⁷
- 38 White Balance Fine Adjustment (P90)
- 39 White Balance Bracket (P90)
- 40 My Colour Mode adjustment (P104)
- 41 Current date and time/✈: Travel destination setting*^{2, 4} (P116)
- 42 Custom settings (P105)
- 43 Programme Shift (P37)
- 44 AE lock (P87)
- 45 Face Recognition (P109)
- 46 AF lock (P87)
- 47 Mic level display (P129)
- Age*^{2, 5} (P101)
- Location*^{2, 4} (P115)
- 48 Simultaneous recording indicator (P108)
- Name*^{2, 5} (P101)
- Number of days that have passed since the departure date*^{2, 4} (P115)
- 49 Self-timer*⁶ (P81)
- 50 Spot metering target (P122)
- 51 Aspect Bracket (P125)
- 52 WIND CUT (P129)

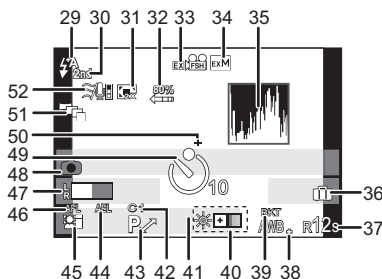



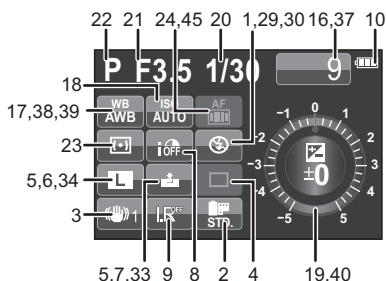

LCD recording information



- *1 Only displayed in the LCD recording information window.
- *2 Only displayed in the LCD monitor.
- *3 It is possible to switch the display between the number of recordable pictures and available recording time with the [REMAINING DISP.] setting in the [CUSTOM] menu.
- *4 This is displayed for about 5 seconds when the camera is turned on, after setting the clock and after switching from Playback Mode to Recording Mode.
- *5 This is displayed for about 5 seconds when this unit is turned on in [BABY1]/[BABY2] or [PET] in Scene Mode.
- *6 This is displayed during countdown.
- *7 "m" is an abbreviation for minute and "s" for second.

■ In playback

- 1 Playback Mode (P39)
- 2 Film Mode (P118)
- 3 Protected picture (P152)
- 4 Number of prints (P151)
- 5 Picture size (P120)
 - REC MODE (when recording motion pictures) (P127)/Recording quality (P127)
- 6 Quality (P121)
- 7 Intelligent Dynamic Range Control (P124)
- 8 Intelligent Resolution (P123)
- 9 Battery indication (P26)
- 10 Picture number/Total pictures
 - Elapsed playback time (P46): 8m30s *1
- 11 Number of pictures in burst (P139)
 - Motion picture recording time (P46): 8m30s *1
- 12 Playback (Motion Picture, Burst Pictures) (P46, 137)
- 13 Favourites settings (P150)
- 14 Recording information *2
- 15 Age (P101)
- 16 Name *3 (P101, 112)/Location *3 (P115)/ Title *3 (P144)
- 17 Number of days that have passed since the departure date (P115)
- 18 Currently retrieving information icon (P185)
- 19  : Motion picture playback (P46)
- 20  : Burst Playback (P137)
- 21 Stamped with text indication (P145)
- 22 Favourites (P150)
 - Cable disconnection warning icon (P167)
- 23 Recorded date and time/ World Time (P116)
- 24 Folder/File number *2 (P166)
- 25 Histogram (P66)

*1 "m" is an abbreviation for minute and "s" for second.

*2 This is not displayed for motion pictures recorded in [AVCHD].

*3 It is displayed in order of [TITLE], [LOCATION], [NAME] ([BABY1]/[BABY2], [PET]), [NAME] ([FACE RECOG.]).

*4 This is not displayed for motion pictures recorded in [AVCHD]/[MOTION JPEG].

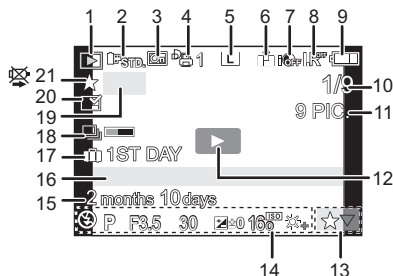

Detailed information display

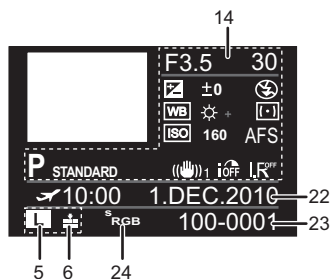

Histogram display

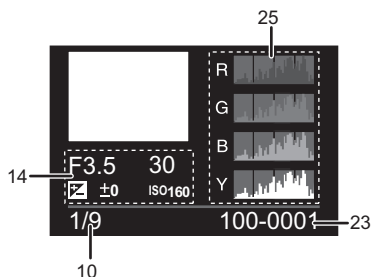

Cautions for Use

Optimal use of the camera

Take care not to drop or knock the unit or put a lot of pressure on it.

- Take care not to knock or drop the bag/case that you inserted the camera in as the shock may cause damage to the camera, lens or LCD monitor.
- Do not use a paper bag as it can easily rip causing the camera to fall and be damaged.
- We strongly recommend you purchase a good camera bag/case from your local dealer to protect your camera.

Keep this unit as far away as possible from electromagnetic equipment (such as microwave ovens, TVs, video games etc.).

- If you use this unit on top of or near a TV, the pictures and/or sound on this unit may be disrupted by electromagnetic wave radiation.
- Do not use this unit near cell phones because doing so may result in noise adversely affecting the pictures and/or sound.
- Recorded data may be damaged, or pictures may be distorted, by strong magnetic fields created by speakers or large motors.
- Electromagnetic wave radiation generated by microprocessors may adversely affect this unit, disturbing the pictures and/or sound.
- If this unit is adversely affected by electromagnetic equipment and stops functioning properly, turn this unit off and remove the battery or disconnect AC adaptor (DMW-AC8E; optional). Then reinsert the battery or reconnect AC adaptor and turn this unit on.

Do not use this unit near radio transmitters or high-voltage lines.

- If you record near radio transmitters or high-voltage lines, the recorded pictures and/or sound may be adversely affected.

Always use the supplied cords and cables. If you use optional accessories, use the cords and the cables supplied with them.**Do not extend the cords or the cables.****Do not spray the camera with insecticides or volatile chemicals.**

- If the camera is sprayed with such chemicals, the body of the camera may be damaged and the surface finish may peel off.
- Do not keep rubber or plastic products in contact with the camera for a long period of time.

Cleaning

Before cleaning the camera, remove the battery or the DC coupler (DMW-DCC8; optional), or disconnect the power plug from the outlet. Then wipe the camera with a dry soft cloth.

- When the camera is soiled badly, it can be cleaned by wiping the dirt off with a wrung wet cloth, and then with a dry cloth.
- Wipe off any dirt or dust on the zoom ring and the focus ring with a dry, dustless cloth.
- Do not use solvents such as benzine, thinner, alcohol, kitchen detergents, etc., to clean the camera, since it may deteriorate the external case or the coating may peel off.
- When using a chemical cloth, be sure to follow the accompanying instructions.

■ About dirt on the image sensor

This camera features an interchangeable lens system so dirt may get inside the camera body when changing lenses. Depending on the recording conditions, dirt on the image sensor may appear on the recorded picture.

Do not change lenses where there is a lot of dust, and always attach the body cap when a lens is not attached to the camera, so that dirt or dust does not get inside the camera body. Remove any dirt on the body cap before attaching it.

Dust reduction function

This unit has a dust reduction function that will blow off the debris and dust that have affixed to the front of the imaging device. This function will function automatically when the camera is turned on, but if you see dust, perform the [SENSOR CLEANING] (P136) in the [CUSTOM] menu.

Removing dirt on the image sensor

The image sensor is very precise and delicate, so be sure to observe the following when you do have to clean it yourself.

- Blow off the dust on the surface of the image sensor with a commercially available blower brush. Be careful not to blow too strongly.
- Do not put the blower brush further inside than the lens mount.
- Do not let the blower brush touch the image sensor as the image sensor may get scratched.
- Do not use any objects except a blower brush to clean the image sensor.
- If you cannot remove the dirt or dust with the blower, consult the dealer or your nearest Service Centre.

For care of the eye cup on the viewfinder

- As the eye cup cannot be removed, gently wipe it with a dry and soft cloth, and be careful not to remove it.
- If you wipe the eye cup too hard and it is removed, consult the dealer or your nearest Service Centre.

About the LCD monitor/Viewfinder

- Do not press the LCD monitor with excessive force. Uneven colours may appear on the LCD monitor and it may malfunction.
- If the camera is cold when you turn it on, the picture on the LCD monitor/Viewfinder will be slightly darker than usual at first. However, the picture will return to normal brightness when the internal temperature of the camera increases.

Extremely high precision technology is employed to produce the LCD monitor/Viewfinder screen. However there may be some dark or bright spots (red, blue or green) on the screen. This is not a malfunction. The LCD monitor/Viewfinder screen has more than 99.99% effective pixels with a mere 0.01% of the pixels inactive or always lit. The spots will not be recorded on pictures on a card.

About the Lens

- Do not press the lens with excessive force.
- Do not leave the camera with the lens facing the sun as rays of light from the sun may cause it to malfunction. Also, be careful when placing the camera outside or near a window.
- When there is dirt (water, oil, and fingerprints, etc.) on the surface of the lens, the picture may be affected. Lightly wipe the surface of the lens with a soft, dry cloth before and after taking pictures.
- Do not place the lens mount facing downwards. Do not allow the lens mount contacts ① to become dirty.

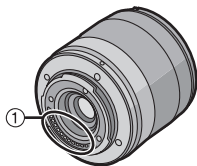

Battery

The battery is a rechargeable lithium ion battery. Its ability to generate power comes from the chemical reaction that takes place inside it. This reaction is susceptible to the surrounding temperature and humidity. If the temperature is too high or too low, the operating time of the battery will become shorter.

Always remove the battery after use.

- Store the removed battery in the battery case (supplied).
- To remove the battery, push it out by putting your finger through the hole in the bottom of the battery case.

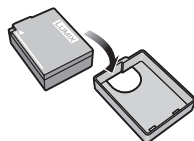

If you drop the battery accidentally, check to see if the body of the battery and the terminals are damaged.

- Inserting a damaged battery in the camera will damage the camera.

Bring charged spare batteries when going out.

- Be aware that the operating time of the battery becomes shorter in low temperature conditions such as at a ski resort.
- When you travel, do not forget to bring the battery charger (supplied) so that you can charge the battery in the country that you are travelling in.

Dispose of unusable battery.

- The battery has a limited life.
- Do not throw the battery into fire because it may cause an explosion.

Do not allow battery terminals to come into contact with metal objects (such as necklaces, hairpins etc.).

- This can cause short circuiting or heat generation and you may be badly burned if you touch a battery.

Charger

- If you use the battery charger near a radio, the radio reception may be disturbed.
- Keep the charger 1 m (3.28 feet) or more away from radio.
- The charger may generate whirring sounds when it is being used. This is not a malfunction.
- After use, be sure to disconnect the power supply device from the electrical outlet. (A very small amount of current is consumed if it is left connected.)
- Keep the terminals of the charger and battery clean.

About 3D

■ About 3D recording

With the 3D interchangeable lens attached, do not record a subject at less than the minimum focus distance.

- The 3D effects may be more pronounced, and therefore cause tiredness or discomfort.
- When the 3D interchangeable lens (H-FT012; optional) is used, the minimum focus distance is 0.6 m (1.97 feet).

When recording with the 3D interchangeable lens attached, be careful not to shake the unit.

- Tiredness or discomfort may result if the shake is pronounced, due to riding in a vehicle or walking etc.
- We recommend using a tripod.

■ About 3D viewing

Anyone who is hyper sensitive to light, suffers from heart disease or is otherwise unwell should avoid viewing 3D pictures.

- Doing may have an adverse affect on such medical conditions.

If you feel tired, uncomfortable or otherwise strange when viewing 3D pictures, stop viewing at once.

- Continuing to view may cause illness.
- Please rest appropriately after stopping the viewing.

When viewing 3D pictures, we recommend taking a break every 30 to 60 minutes.

- Viewing for extended periods may cause eye-fatigue.

Short-sighted or long-sighted persons, those with differences in the sight of their right and left eyes, and those with astigmatism are advised to correct their vision by wearing glasses etc.

Stop viewing if you can clearly see a double image while viewing 3D pictures.

- There are differences in the way that different people experience 3D pictures. Please correct your sight appropriately before viewing 3D pictures.
- You can change the 3D setting of your television or 3D output setting of the unit to 2D.

When viewing 3D pictures on a 3D compatible television, position yourself a distance away that is at least 3 times the effective height of the television.

- (Recommended distance): For 106.7 cm (42"); approx. 1.6 m (5.25 feet), for 116.8 cm (46"); approx. 1.7 m (5.58 feet), for 127 cm (50"); approx. 1.9 m (6.23 feet), for 137.2 cm (54"); approx. 2.0 m (6.56 feet).
- Viewing from a distance closer than the recommended distance may lead to eye-fatigue.

Card

Do not leave the card where the temperature is high, where electromagnetic waves or static electricity are easily generated or exposed to direct sunlight.

Do not bend or drop the card.

- The card may be damaged or the recorded content may be damaged or deleted.
- Put the card in the card case or the storage bag after use and when storing or carrying the card.
- Do not allow dirt, dust or water to get into the terminals on the back of the card and do not touch the terminals with your fingers.

Notice for when transferring to another party, or disposing of the memory card

- "Format" or "delete" using the camera or a PC will only modify the file management information, and it will not erase the data in the memory card completely.

It is recommended to physically destroy the memory card or use the commercially available computer data deletion software to completely erase the data in the memory card before transferring to another party or disposing.

Management of data in the memory card is the responsibility of the user.

About the personal information

If a name or birthday is set for [BABY1]/[BABY2]/Face Recognition function, this personal information is kept in the camera and recorded in the image.

Disclaimer

- Information including personal information may be altered or vanish due to erroneous operation, effect of static electricity, accident, malfunction, repair, or other handlings. Please note in advance that Panasonic is not liable in any way for any direct or indirect damage from the alteration or vanishing of information or personal information.

When requesting a repair, transferring to another party or disposing

- Reset the settings to protect the personal information. (P63)
- Remove the memory card from the camera when requesting a repair.
- Settings may return to factory default when camera is repaired.
- Please contact the dealer where you purchased the camera or your nearest Service Centre if above operations are not possible due to malfunction.

When transferring to another party, or disposing of the memory card, please refer to "Notice for when transferring to another party, or disposing of the memory card" on P181.

When not using the camera for a long period of time

- Store the battery in a cool and dry place with a relatively stable temperature: [Recommended temperature: 15 °C to 25 °C (59 °F to 77 °F), Recommended humidity: 40%RH to 60%RH]
- Always remove the battery and the card from the camera.
- If the battery is left inserted in the camera, it will discharge even if the camera is turned off. If the battery continues to be left in the camera, it will discharge excessively and may become unusable even if charged.
- When storing the battery for a long period of time, we recommend charging it once a year. Remove the battery from the camera and store it again after it has completely discharged.
- We recommend storing the camera with a desiccant (silica gel) when you keep it in a closet or a cabinet.
- **Check all the parts before taking pictures when you have not used the camera for a long period of time.**

About the picture data

- Recorded data may be damaged or lost if the camera breaks down due to inappropriate handling. Panasonic will not be liable for any damage suffered due to loss of recorded data.

About tripods or unipods

- When you use a tripod, make sure the tripod is stable when this unit is attached to it.
- You may not be able to remove the card or the battery when using a tripod or unipod.
- Make sure that the screw on the tripod or unipod is not at an angle when attaching or detaching the camera. You may damage the screw on the camera if you use excessive force when turning it. Also, the camera body and the rating label may be damaged or scratched if the camera is attached too tightly to the tripod or unipod.
- When using this unit with a large-diameter lens, the lens may come into contact with the pedestal depending on the tripod/unipod. Tightening the screw with the lens and pedestal in contact with each other may damage this unit or the lens. Therefore it is recommended to attach the tripod adaptor (DMW-TA1; optional) before mounting on the tripod/unipod.
- Read the operating instructions for the tripod or unipod carefully.

About the shoulder strap

- If you attach a heavy interchangeable lens (more than about 1 kg) to the camera body, do not carry the camera by the shoulder strap. Hold the camera and the lens when carrying them.

Message Display

Confirmation messages or error messages will be displayed on the screen in some cases. The major messages are described below as examples.

[THIS PICTURE IS PROTECTED]

→ Delete the picture after cancelling the protect setting. (P152)

[THIS PICTURE CANNOT BE DELETED]/[SOME PICTURES CANNOT BE DELETED]

- Pictures not based on the DCF standard cannot be deleted.
 - If you want to delete some pictures, format the card after saving necessary data on a PC etc. (P63)

[NO ADDITIONAL SELECTIONS CAN BE MADE]

- The number of pictures, which can be set at one time when [MULTI] has been selected for [DELETE MULTI] (P52), [FAVORITE] (P150), [TITLE EDIT] (P144), [TEXT STAMP] (P145) or [RESIZE] (P147) has been exceeded.
 - Reduce the number of pictures set, and then repeat the operation.
- More than 999 favourites have been set.

[CANNOT BE SET ON THIS PICTURE]

- [TITLE EDIT], [TEXT STAMP] or [PRINT SET] cannot be set for pictures not based on the DCF standard.

[MEMORY CARD ERROR FORMAT THIS CARD?]

- It is a format that cannot be used with this unit.
 - Format the card again with the camera after saving necessary data on a PC etc. (P63)

[LENS NOT FOUND, OR C_Y SHOOT W/O LENS IS SET TO OFF.]/ [THE LENS IS NOT ATTACHED PROPERLY. DO NOT PUSH LENS RELEASE BUTTON WHILE LENS IS ATTACHED.]/ [PLEASE CHECK THAT THE LENS IS ATTACHED CORRECTLY]

- Do not press the lens release button while taking pictures.
- When using a Leica lens mount adaptor (DMW-MA2M or DMW-MA3R; optional), set [SHOOT W/O LENS] (P136) to [ON] in the custom menu.
- Detach the lens once, and then attach it again without pressing the lens release button. (P21)
Turn on the power again, and if it is still displaying, contact the dealer.

[MEMORY CARD PARAMETER ERROR]/[THIS MEMORY CARD CANNOT BE USED]

- Use a card compatible with this unit. (P29)
- SD Memory Card (8 MB to 2 GB)
- SDHC Memory Card (4 GB to 32 GB)
- SDXC Memory Card (48 GB, 64 GB)

[INSERT SD CARD AGAIN]/[TRY ANOTHER CARD]

- An error has occurred accessing the card.
 - Insert the card again.
 - Insert a different card.

[READ ERROR/WRITE ERROR PLEASE CHECK THE CARD]

- It has failed to read or write data.
 - Remove the card after turning the power [OFF]. Insert the card again, turn the power on, and try to read or write the data again.
- The card may be broken.
 - Insert a different card.

[CANNOT RECORD DUE TO INCOMPATIBLE FORMAT (NTSC/PAL) DATA ON THIS CARD.]

- If you want to delete some pictures, format the card after saving necessary data on a PC etc. (P63)
- Insert a different card.

[MOTION RECORDING WAS CANCELLED DUE TO THE LIMITATION OF THE WRITING SPEED OF THE CARD]

- Use a card with SD Speed Class with "Class 4" or higher when recording motion pictures in [AVCHD].
Also, use a card with SD Speed Class with "Class 6" or higher when recording motion pictures in [MOTION JPEG].
- In the event that it stops even after using a "Class 4" card or higher, the data writing speed has deteriorated so it is recommended to make a backup and then format (P63).
- Depending on the type of the card, motion picture recording may stop in the middle.

[THIS CARD IS NOT FORMATTED WITH THIS CAMERA, AND NOT SUITABLE FOR MOVIE RECORDING.]

- The writing speed is lower if the card has been formatted using a PC or other equipment. As a consequence, motion picture recording may stop in the middle. If this happens, make a backup of the data and format (P63) the card in this unit.

[A FOLDER CANNOT BE CREATED]

- A folder cannot be created because there are no remaining folder numbers that can be used. (P166)
 - Format the card after saving necessary data on a PC etc. (P63) If you execute [NO.RESET] in the [SETUP] menu after formatting, the folder number is reset to 100. (P63)

[PICTURE IS DISPLAYED FOR 16:9 TV]/[PICTURE IS DISPLAYED FOR 4:3 TV]

- The AV cable is connected to the camera.
 - Press [MENU/SET] if you want to delete this message at once.
 - Select [TV ASPECT] in the [SETUP] menu if you want to change the TV aspect. (P60)
- This message also appears when the USB connection cable is connected to the camera only. In this case, connect the other end of the USB connection cable to a PC or a printer. (P164, 167)

[THIS BATTERY CANNOT BE USED]

- The battery cannot be recognised by the camera.
 - Use a genuine Panasonic battery. If this message is displayed even when a genuine Panasonic battery is used, contact the dealer or your nearest Service Centre.
- The battery cannot be recognised as its terminal is dirty.
 - Remove any dirt etc. from the terminal.

[PLEASE MAKE SURE TO TURN ON THE POWER OF EXTERNAL MICROPHONE.]

- When attaching the stereo microphone (DMW-MS1; optional), check the battery status and make sure the power is on before use. (P173)

[EDITING OPERATION CANNOT PROCEED AS INFORMATION PROCESSING IS ONGOING.]

When a card with pictures deleted or file names changed using a PC or other device is inserted into this unit, it will automatically retrieve new information and reconstruct the burst groups. The currently retrieving information icon [] may be displayed in the playback screen for long period of time when there are many image files, and deletion or [PLAYBACK] Mode menu cannot be used during this time.

- If you switch the power switch to [OFF] while information is being retrieved, the pictures for which information was retrieved up to that point will be saved as a burst group. When you switch on again, the information retrieval will restart from the same point.

Troubleshooting

First, try out the following procedures (P186–194).

If the problem is not resolved, it may be improved by selecting **[RESET] (P63)** on the **[SETUP] menu**.

Battery and power source

**The camera cannot be operated even when it is turned on.
The camera turns off immediately after it is turned on.**

- The battery is exhausted.
- Charge the battery.
- If you leave the camera on, the battery will be exhausted.
→ Turn the camera off frequently by using the **[ECONOMY] Mode** etc. (P59)

This unit is turned off automatically.

- If you connect to a TV compatible with VIERA Link with a HDMI mini cable (optional) and turn off the power on the TV with the remote control for the TV, the power on this unit also turns off.
→ If you are not using VIERA Link, set **[VIERA Link]** to **[OFF]**. (P61)

The [CHARGE] lamp flashes.

- Is the temperature of the battery excessively high or low? If it is, it will take longer than usual to charge the battery or charging may remain incomplete.
- Are the terminals of the charger or battery dirty?
→ Wipe off the dirt using a dry cloth.

Recording

**Taking pictures is not possible.
The shutter will not operate immediately when the shutter button is pressed.**

- Is the subject focused?
→ **[FOCUS PRIORITY]** is set to **[ON]** at the time of purchase, and so you cannot take pictures until the subject is in focus. If you want to be able to take a picture when you press the shutter button fully even if the subject is not focused, set **[FOCUS PRIORITY]** in the **[CUSTOM] menu** to **[OFF]**. (P131)
- You may not be able to record for a short while after turning the power **[ON]** when using a large capacity card.

The recorded picture is whitish.

- Picture might look whitish when lens or image sensor gets dirty with finger print or similar.
→ If the lens is dirty turn the camera off and then gently wipe the lens surface with a soft dry cloth.
→ Refer to P178 when the image sensor gets dirty.

The recorded picture is too bright or dark.

- Check that the exposure is correctly compensated. (P76)
- Is the AE Lock (P87) applied incorrectly?

Multiple pictures are taken at one time.

- Unset the settings of White Balance Bracket (P90).
- Set [ASPECT BRACKET] (P125) to [OFF].

The subject is not focused properly.

- The subject is beyond the focus range of the camera. (P34)
- There is camera shake (jitter) or the subject is moving slightly. (P75)
- Is [FOCUS PRIORITY] in the [CUSTOM] menu set to [OFF]? (P131)
In this case, the picture may not be properly focused even if [AFS] or [AFC] in Focus Mode is set.
- Is [SHUTTER AF] in the [CUSTOM] menu set to [OFF]? (P132)
- Is the AF Lock (P87) applied incorrectly?

The recorded picture is blurred.

The Optical Image Stabilizer is not effective.

- The shutter speed will become slower and the Optical Image Stabilizer function may not work properly when taking pictures especially in dark places.
 - We recommend holding the camera firmly with both hands when taking pictures. (P36)
 - We recommend using a tripod and the self-timer (P81) when taking pictures with a slow shutter speed.

Taking pictures using White Balance Bracket/[ASPECT BRACKET] is not possible.

- Is there any memory remaining on the card?

The recorded picture looks rough.

Noise appears on the picture.

- Is the ISO sensitivity high or the shutter speed slow? (ISO sensitivity is set to [AUTO] when the camera is shipped. Therefore, when taking pictures indoors etc. noise will appear.)
 - Decrease the ISO sensitivity. (P91)
 - Increase the setting for [NOISE REDUCTION] in [FILM MODE] or lower the setting for each of the items other than [NOISE REDUCTION]. (P118)
 - Take pictures in bright places.
 - Set the [LONG SHTR NR] to [ON]. (P124)
- Is the [PICTURE SIZE] (P120) or the [QUALITY] (P121) set low?
- Is the [DIGITAL ZOOM] set? (P67)

Under fluorescent lighting, flicker or horizontal bars may be seen.

- This is characteristic of MOS sensors which serve as the camera's pickup sensors.
This is not a malfunction.
- If the flicker or horizontal bars stand out, record in the Creative Motion Picture Mode and set the shutter speed to 1/100 in areas where the supply frequency is 50 Hz, or 1/60 in areas of 60 Hz.



The brightness or the hue of the recorded picture is different from the actual scene.

- If recording under fluorescent light, the brightness or the hue may change slightly when the shutter speed becomes fast. This occurs due to the characteristics of fluorescent light. It is not a malfunction.
- Colour or brightness of the screen may change or horizontal streaks may appear on the screen when the picture is taken under extremely bright light, or under fluorescent lamps, mercury lamps, or sodium lamps etc.

Reddish horizontal streaks appear on the LCD monitor during recording.

- This is characteristic of MOS sensors which serve as the camera's pickup sensors. It appears when the subject has a bright part. Some unevenness may occur in the surrounding areas, but this is not a malfunction.
- It is recommended that you take pictures while taking care not to expose the screen to sunlight or any other source of strong light.

Bright spot not in subject is recorded.

- This could be an inactive pixel. Perform the [PIXEL REFRESH] (P135) in the [CUSTOM] menu.

You cannot compensate the exposure.

- Are you in Exposure Compensation operation?
→ Press the rear dial to switch to Exposure Compensation operation. (P76)

**Subject cannot be locked.
(AF tracking not possible)**

- Set the AF area to the distinctive colour of the subject if there is a part that is different from the surrounding colour. (P83)

Motion pictures**Motion picture recording stops in the middle.**

- Use a card with SD Speed Class with "Class 4" or higher when recording motion pictures in [AVCHD].
Also, use a card with SD Speed Class with "Class 6" or higher when recording motion pictures in [MOTION JPEG].
- Depending on the type of the card, recording may stop in the middle.
→ If motion picture recording stops during use of a card of at least "Class 4" or if you use a card on which recording and deleting have been repeated many times, or a card that has been formatted on a PC or other equipment, the data-writing speed is lower. In such cases, we recommend that you make a backup of the data and then format (P63) the card in this unit.

When recording a motion picture, the screen may go dark.

- When recording a motion picture, the screen may go dark after a certain period to reduce battery consumption, but this will not affect the recorded motion picture.

The screen may be blacked out momentarily, or the unit may record noise.

- The screen may be blacked out momentarily, or the unit may record noise due to static electricity or electromagnetic waves etc. depending on the environment of the motion picture recording.

Object seems to be warped.

- Object seems to be warped slightly when the object moves across the image very fast, but this is because the unit is using MOS for the image sensor. This is not a malfunction.

In motion pictures, abnormal clicking and buzzing sounds are recorded.

- With recording in a quiet environment, depending on the lenses used, the sound of aperture and focus actions may be recorded in motion pictures. This is not a malfunction. Focus operation while recording motion pictures can be set to [OFF] with [CONTINUOUS AF] (P43).
- Be careful while recording motion pictures because the sounds of the zoom operations, buttons and dial operation etc. may be recorded.

Lens**Recorded image may be warped, or nonexistent colour is surrounding the subject.**

- Depending on the lens used, picture may be warped slightly or you may see colours along the edge depending on the zoom factor, due to the characteristics of the lens. Also, the peripherals of the image might look warped because the perspective is enhanced when the wide angle is used. This is not a malfunction.

When the lens is attached to another digital camera, stabilizer function cannot be turned off or stabilizer function does not work.

- The Optical Image Stabilizer function of the 14–42 mm/F3.5–5.6 lens supplied in DMC-GH2K only works correctly with supported cameras.
 - When older Panasonic digital cameras (DMC-GF1, DMC-GH1, DMC-G1) are used, [STABILIZER] in the [REC] Mode menu (P75) cannot be set to [OFF]. It is recommended to update the firmware of the digital camera at the following website.
<http://panasonic.jp/support/global/cs/dsc/download/>
 - When using this lens with another make of digital cameras, the Optical Image Stabilizer function will not work. (As of October 2010)
For details, contact the respective company.

Flash**The flash is not activated.**

- Is the flash closed?
 - Slide the [ OPEN] lever to open the flash. (P69)

The flash is activated 2 times.

- The flash is activated 2 times. The interval between the first and second flash is longer when Red-eye Reduction (P70) is set so the subject should not move until the second flash is activated.

LCD monitor/Viewfinder

The LCD monitor turns off although the camera is turned on.

- The LCD monitor turns off when [AUTO LCD OFF] (P59) is selected for the [ECONOMY] Mode. [This does not happen when using the AC adaptor (DMW-AC8E; optional).]
- It will switch to viewfinder display if there is hand or object near the eye sensor. (P16)

The LCD monitor/Viewfinder is too bright or dark.

- Adjust the brightness of the LCD monitor/viewfinder to a proper level. (P58)
- Check [LCD MODE] setting. (P59)

It may flicker for an instant or the brightness of the screen may change significantly for an instant.

- This occurs due to the aperture of the lens changing when the shutter button is pressed half-way, or when the brightness of the subject changes. This is not a malfunction.

The picture is not displayed on the LCD monitor.

- Does the picture appear on the viewfinder?
 - Press [LVF/LCD] to switch to LCD monitor display. (P16)
- Is the LCD monitor switched off?
 - Switch the display by pressing [DISPLAY]. (P64)

LCD monitor and viewfinder do not switch when [LVF/LCD] is pressed.

- Is the [EXPO. SETTINGS] set to [SWITCH BY PRESSING THE LVF/LCD BUTTON]? (P133)
- It is only displayed on the LCD monitor when the camera is connected to a PC or printer.

Black, red, blue and green dots appear on the LCD monitor.

- This is not a malfunction.
These pixels do not affect the recorded pictures.

Noise appears on the LCD monitor.

- In dark places, noise may appear to maintain the brightness of the LCD monitor.

You see red, green, or blue flashes when you move your eyes in the viewfinder, or when the camera is moved rapidly.

- This is a characteristic of the drive system of the viewfinder of this unit, and it is not a malfunction. There will be no problem with the recorded image.

Playback

The picture being played back is not rotated, or is rotated in an unexpected direction, when displayed.

- You can display the pictures without being rotated when [ROTATE DISP.] (P149) is set to [OFF].
- You can rotate pictures with the [ROTATE] function. (P149)
- You can only display the pictures rotated if you use a lens (P19) that supports the Direction Detection Function (P36) and [ROTATE DISP.] is set to [ON].

The picture is not played back. There are no recorded pictures.

- Did you press [▶]?
- Is the card inserted?
- Is there a picture on the card?
- Is this a picture whose file name has been changed in the PC? If it is, it cannot be played back by this unit.
- Has [PLAYBACK MODE] been set for playback?
→ Change to [NORMAL PLAY]. (P143)

The folder number and the file number are displayed as [—] and the screen turns black.

- Is this a non-standard picture, a picture which has been edited using a PC or a picture which was taken by another make of digital camera?
- Did you remove the battery immediately after picture-taking or did you take the picture using a battery with a low remaining charge?
→ Format the data to delete the pictures mentioned above. (P63)
(Other pictures will be deleted as well and it will not be possible to restore them. Therefore, check well before formatting.)

Images with different date as recorded date are played back in the Calendar Playback.

- Is the clock in the camera set properly? (P31)
- Images edited on a PC or images recorded on other cameras might display a different date to the recorded date during the Calendar Playback.

White round spots like soap bubbles appear on the recorded picture.

- If you take a picture with the flash in a dark place or indoors, white round spots may appear on the picture caused by the flash reflecting of particles of dust in the air. This is not a malfunction. A characteristic of this is that the number of round spots and their position differ in every picture.



[THUMBNAIL IS DISPLAYED] appears on the screen.

- Is it a picture that has been recorded with other equipment? In such cases, these pictures may be displayed with a deteriorated picture quality.

Red part of the recorded image has changed colour to black.

- When Digital Red-Eye Correction ([], [], []) is in operation, if you take a picture of subject with red colour surrounded by a skin tone colour, that red part may be corrected to black by the Digital Red-Eye Correction function.
 - It is recommended to take pictures with the flash closed, Flash Mode set to [A] or [], or [RED-EYE REMOVAL] set to [OFF]. (P123)

TV, PC and printer

The picture does not appear on the television.

- Is the camera connected to the TV correctly?
 - Set the TV input to external input mode.
- Output from the [HDMI] socket is not possible when it is connected to the PC or the printer.
 - Connect it only to the TV.

The display areas on the TV screen and the camera's LCD monitor are different.

- Depending on the TV model, the pictures may be extended horizontally or vertically or they may be displayed with their edges cut off.

The motion pictures cannot be played back on a TV.

- Are you trying to play back the motion pictures by directly inserting the card in the card slot of the TV?
 - Connect the camera to the TV with the AV cable (supplied), or with the HDMI mini cable (optional), and then play back the motion pictures on the camera. (P157, 158)
 - Motion pictures recorded in [AVCHD] can be played back on Panasonic televisions (VIERA) with the AVCHD logo.

The picture is not displayed fully on the TV.

- Check [TV ASPECT] setting. (P60)

VIERA Link does not work.

- Is it connected properly with the HDMI mini cable (optional)? (P158)
 - Confirm that the HDMI mini-cable (optional) is firmly fitted.
 - Press [] on this unit.
- Is the [VIERA Link] on this unit set to [ON]? (P61)
 - Depending on HDMI terminal of the TV, the input channel may not switch automatically. In this case, use the remote control for the TV to switch input. (For details on how to switch input, please read the operating instructions for the TV.)
 - Check the VIERA Link setting on the connected device.
 - Turn the power to the unit off and then back on again.
 - Set [VIERA Link] to [Off] on the TV and then turn it back to [On]. (Refer to the operating instructions of the TV for details.)
 - Check [VIDEO OUT] setting. (P60)

The picture cannot be transferred when the camera is connected to a PC.

- Is the camera connected to the PC correctly?
- Is the camera recognised by the PC correctly?
 - Set to [PC] in [USB MODE]. (P60, 164)

The card is not recognised by the PC.

- Disconnect the USB connection cable. Connect it again while the card is inserted in the camera.

The card is not recognised by the PC. (SDXC memory card is used)

- Check if your PC is compatible with SDXC memory cards.
<http://panasonic.net/avc/sdcard/information/SDXC.html>
- A message prompting to format the card may be displayed when connecting, but do not format.
- If the [ACCESS] displayed on the LCD monitor does not disappear, disconnect the USB connection cable after turning off the power.

The picture cannot be printed when the camera is connected to a printer.

- Pictures cannot be printed using a printer which does not support PictBridge.
 - Set to [PictBridge(PTP)] in [USB MODE]. (P60, 167)

The ends of the pictures are cut at printing.

- When using a printer with a Cropping or borderless printing function, cancel this function before printing. (For details, refer to the operating instructions for the printer.)
- When you order photo studios to print pictures, ask the photo studio if the pictures can be printed with both ends.



Others**The camera makes a noise when turned [ON].**

- This is the noise of the Dust Reduction Function working (P178); it is not a malfunction.

There is a sound from lens unit.

- It is a sound of lens movement or aperture operation when the power is turned [ON] or [OFF], and it is not a malfunction.
- You may hear a sound from the lens and image in the LCD monitor may suddenly change when the brightness has changed by zoom operation or moving the camera, but there is no effect on recording.
The sound is caused by the automatic adjustment of the aperture. This is not a malfunction.

An unreadable language was selected by mistake.

- Press [MENU/SET], select the [SETUP] menu icon [] and then select the [] icon to set the desired language. (P62)

Part of the picture is flashing in black and white.

- This is a highlight function showing the white saturated area. (P130)
- Is the [HIGHLIGHT] set to [ON]?

A red lamp sometimes turns on when the shutter button is pressed halfway.

- In dark places, the AF Assist Lamp (P132) lights red to make it easier to focus on a subject.

The AF Assist Lamp does not turn on.

- Is [AF ASSIST LAMP] on the [CUSTOM] menu set to [ON]? (P132)
- The AF Assist Lamp does not turn on in bright places.

The camera becomes warm.

- The surface of the camera and the reverse side of the LCD monitor may become warm during use. This does not affect the performance or quality of the camera.

The clock is reset.

- If you do not use the camera for a long time, the clock may be reset.
 - [PLEASE SET THE CLOCK] message will be displayed; please re-set the clock. When taking pictures, it will not be possible to record the correct date without setting the clock. (P31)

The file numbers are not recorded consecutively.

- When you perform an operation after taking a certain action, the pictures may be recorded in folders with different numbers from the ones used prior to the operation. (P166)

The file numbers are recorded in ascending order.

- If the battery was inserted or removed without first turning the camera's power off, the folder and file numbers for the pictures taken will not be stored in the memory. When the power is then turned back on and pictures are taken, they may be stored under file numbers which should have been assigned to previous pictures.

Age is not displayed correctly.

- Check the clock (P31) and birthday settings (P101).

A different thing gets selected from what you touched.

- Perform the calibration (P62).

Specifications

Digital Camera Body

(DMC-GH2):

Information for your safety

Power Source:	DC 8.4 V
Power Consumption:	3.4 W (When recording with LCD Monitor) (When the 14–140 mm/F4.0–5.8 lens supplied in DMC-GH2H is used) 3.2 W (When recording with LCD Monitor) (When the 14–42 mm/F3.5–5.6 lens supplied in DMC-GH2K is used) 2.6 W (When playing back with LCD Monitor) (When the 14–140 mm/F4.0–5.8 lens supplied in DMC-GH2H is used) 2.5 W (When playing back with LCD Monitor) (When the 14–42 mm/F3.5–5.6 lens supplied in DMC-GH2K is used)

Camera effective pixels: 16,050,000 pixels

Image sensor: 4/3" Live MOS sensor, total pixel number 18,310,000 pixels, Primary colour filter

Digital Zoom: Max. 4×

Extra Tele Conversion: ON/OFF simple enlargement (compatible with lenses from other manufacturers)
(Except for the maximum picture size for each aspect ratio)

Focus: Auto Focus/Manual Focus, Face Detection/AF Tracking/23-area-focusing/1-area-focusing (Touch focus area selection possible)

Shutter system: Focal-plane shutter

Burst recording

Burst speed: 40 pictures/second (Super high speed),
5 pictures/second (High speed),
3 pictures/second (Middle speed),
2 pictures/second (Low speed)

Number of recordable pictures: Max. 7 pictures (when there are RAW files)
Depends on the capacity of the card
(when there are no RAW files)

**ISO sensitivity
(Standard Output
Sensitivity):**

AUTO/ $\frac{1}{\text{iso}}$ /160/200/250/320/400/500/640/800/1000/1250/1600/
2000/2500/3200/4000/5000/6400/8000/10000/12800

Minimum Illumination:	<p>Approx. 6 lx (when i-Low light is used, the shutter speed is 1/25th of a second), Approx. 1 lx (when Creative Motion Picture Mode is used, [ISO3200] is set, the shutter speed is 1/2th of a second)</p> <p>(When the 14–140 mm/F4.0–5.8 lens supplied in DMC-GH2H is used)</p> <p>Approx. 5 lx (when i-Low light is used, the shutter speed is 1/25th of a second), Approx. 1 lx (when Creative Motion Picture Mode is used, [ISO3200] is set, the shutter speed is 1/2th of a second)</p> <p>(When the 14–42 mm/F3.5–5.6 lens supplied in DMC-GH2K is used)</p>
Shutter speed:	<p>B (Bulb) (Max. approx. 120 seconds), 60 seconds to 1/4000th of a second</p> <p>Taking still pictures during motion picture recording</p> <p>Motion picture priorities: 1/25th of a second to 1/16000th of a second</p> <p>Still picture priorities: B (Bulb) (Max. approx. 120 seconds), 60 seconds to 1/4000th of a second</p>
Metering range:	EV 0 to EV 18
White Balance:	Auto White Balance/Daylight/Cloudy/Shade/Incandescent lights/Flash/White set1/White set2/White set3/White set4/White Balance K set
Exposure (AE):	<p>Programme AE (P)/Aperture-priority AE (A)/Shutter-priority AE (S)/Manual exposure (M)/AUTO</p> <p>Exposure Compensation (1/3 EV Step, –5 EV to +5 EV)</p>
Metering Mode:	Multiple/Centre weighted/Spot
LCD monitor:	<p>3.0" TFT LCD (3:2)</p> <p>(Approx. 460,000 dots) (field of view ratio about 100%)</p> <p>Touch panel</p>
Viewfinder:	<p>Colour LCD Viewfinder (Approx. 1,530,000 dots)</p> <p>(field of view ratio about 100%)</p> <p>(with diopter adjustment –4 to +4 diopter)</p>
Flash:	<p>Built-in pop up flash</p> <p>GN 13.9 equivalent (ISO160·m)</p> <p>Flash range:</p> <p>Approx. 1.0 m (3.28 feet) to 4.8 m (15.7 feet)</p> <p>(When the 14–140 mm/F4.0–5.8 lens supplied in DMC-GH2H is mounted, focal length is 22 mm, [ISO AUTO] is set, and the aspect ratio is set to [4:3])</p> <p>Flash range:</p> <p>Approx. 45 cm (1.48 feet) to 6.2 m (20.3 feet)</p> <p>(When the 14–42 mm/F3.5–5.6 lens supplied in DMC-GH2K is mounted, WIDE, [ISO AUTO] is set)</p> <p>AUTO, AUTO/Red-Eye Reduction, Forced ON, Forced ON/Red-eye reduction, Slow Sync., Slow Sync./Red-Eye Reduction, Forced OFF</p>
Flash synchronization speed:	Equal to or smaller than 1/160th of a second

Microphone:	Stereo
Speaker:	Monaural
Recording media:	SD Memory Card/SDHC Memory Card/SDXC Memory Card
Picture size	
Still picture:	When the aspect ratio setting is [4:3] 4608×3456 pixels, 3264×2448 pixels, 2336×1752 pixels When the aspect ratio setting is [3:2] 4752×3168 pixels, 3360×2240 pixels, 2400×1600 pixels When the aspect ratio setting is [16:9] 4976×2800 pixels, 3520×1984 pixels, 1920×1080 pixels When the aspect ratio setting is [1:1] 3456×3456 pixels, 2448×2448 pixels, 1744×1744 pixels
Recording quality	
Motion pictures:	[AVCHD] (With audio) When set to [24H]: 1920×1080 pixels (24p recording/Approx. 24 Mbps)/ When set to [24L]: 1920×1080 pixels (24p recording/Approx. 17 Mbps)/ When set to [FSH]: 1920×1080 pixels (50i recording/Approx. 17 Mbps)/ When set to [FH]: 1920×1080 pixels (50i recording/Approx. 13 Mbps)/ When set to [SH]: 1280×720 pixels (50p recording/Approx. 17 Mbps)/ When set to [H]: 1280×720 pixels (50p recording/Approx. 13 Mbps) [MOTION JPEG] (With audio) When set to [HD]: 1280×720 pixels (30 frames/sec.)/ When set to [WVGA]: 848×480 pixels (30 frames/sec.)/ When set to [VGA]: 640×480 pixels (30 frames/sec.)/ When set to [QVGA]: 320×240 pixels (30 frames/sec.)
Quality:	RAW/RAW+Fine/RAW+Standard/Fine/Standard/MPO+Fine/ MPO+Standard
Recording file format	
Still Picture:	RAW/JPEG (based on "Design rule for Camera File system", based on "Exif 2.3" standard, DPOF corresponding)/MPO
Motion pictures with audio:	AVCHD/QuickTime Motion JPEG
Interface	
Digital:	"USB 2.0" (High Speed)
Analogue video/audio:	NTSC/PAL Composite (Switched by menu) Audio line output (stereo)
Terminal	
[MIC/REMOTE]:	φ 2.5 mm jack
[AV OUT/DIGITAL]:	Dedicated jack (14 pin)
[HDMI]:	MiniHDMI TypeC

Dimensions:	Approx. 124 mm (W)×89.6 mm (H)×75.8 mm (D) [4.88" (W)×3.53"(H)×2.98" (D)] (excluding the projecting parts)
Mass:	Approx. 904 g/1.99 lb (with the 14–140 mm/F4.0–5.8 lens supplied in DMC-GH2H, card and battery) Approx. 609 g/1.34 lb (with the 14–42 mm/F3.5–5.6 lens supplied in DMC-GH2K, card and battery) Approx. 392 g/0.86 lb (camera body)
Operating temperature:	0 °C to 40 °C (32 °F to 104 °F)
Operating humidity:	10%RH to 80%RH

Battery Charger**(Panasonic DE-A80A):** Information for your safety

Input:	AC ~ 110 V to 240 V, 50/60 Hz, 0.2 A
Output:	DC = 8.4 V, 0.65 A

Battery Pack**(lithium-ion)****(Panasonic)****DMW-BLC12E):** Information for your safety

Voltage/capacity:	7.2 V/1200 mAh
--------------------------	----------------

Interchangeable Lens (H-VS014140)**“LUMIX G VARIO HD 14–140 mm/F4.0–5.8 ASPH./MEGA O.I.S.”**

Focal length:	f=14 mm to 140 mm (35 mm film camera equivalent: 28 mm to 280 mm)
Aperture type:	7 diaphragm blades/circular aperture diaphragm
Aperture range:	F4.0 (Wide) to F5.8 (Tele)
Minimum aperture value:	F22
Lens construction:	17 elements in 13 groups (4 aspherical lenses/2 ED lenses)
In focus distance:	0.5 m (1.64 feet) to ∞ (from the focus distance reference line)
Maximum image magnification:	0.2 \times (35 mm film camera equivalent: 0.4 \times)
Optical Image Stabilizer:	Available
[O.I.S.] switch:	Available (Switching ON/OFF)
Mount:	“Micro Four Thirds Mount”
Angle of view:	75° (Wide) to 8.8° (Tele)
Filter diameter:	62 mm (2.44 inch)
Max. diameter:	Approx. 70 mm (2.76 inch)
Overall length:	Approx. 84 mm (3.31 inch) (from the tip of the lens to the base side of the lens mount)
Mass:	Approx. 460 g/1.01 lb

Interchangeable Lens (H-FS014042)**“LUMIX G VARIO 14–42 mm/F3.5–5.6 ASPH./MEGA O.I.S.”**

Focal length:	f=14 mm to 42 mm (35 mm film camera equivalent: 28 mm to 84 mm)
Aperture type:	7 diaphragm blades/circular aperture diaphragm
Aperture range:	F3.5 (Wide) to F5.6 (Tele)
Minimum aperture value:	F22
Lens construction:	12 elements in 9 groups (1 aspherical lens)
In focus distance:	0.3 m (0.99 feet) to ∞ (from the focus distance reference line)
Maximum image magnification:	0.16 \times (35 mm film camera equivalent: 0.32 \times)
Optical Image Stabilizer:	Available
[O.I.S.] switch:	None (Setting of the [STABILIZER] is done in [REC] Mode menu.)
Mount:	“Micro Four Thirds Mount”
Angle of view:	75° (Wide) to 29° (Tele)
Filter diameter:	52 mm (2.05 inch)
Max. diameter:	Approx. 60.6 mm (2.39 inch)
Overall length:	Approx. 63.6 mm (2.50 inch) (from the tip of the lens to the base side of the lens mount)
Mass:	Approx. 165 g/0.22 lb

- G MICRO SYSTEM is a lens exchange type digital camera system of LUMIX based on a Micro Four Thirds System standard.
- Micro Four Thirds™ and Micro Four Thirds Logo marks are trademarks or registered trademarks of Olympus Imaging Corporation, in Japan, the United States, the European Union and other countries.
- Four Thirds™ and Four Thirds Logo marks are trademarks or registered trademarks of Olympus Imaging Corporation, in Japan, the United States, the European Union and other countries.
- SDXC Logo is a trademark of SD-3C, LLC.
- The "AVCHD" and the "AVCHD" logo are trademarks of Panasonic Corporation and Sony Corporation.
- Manufactured under license from Dolby Laboratories. Dolby and the double-D symbol are trademarks of Dolby Laboratories.
- HDMI, the HDMI Logo, and High-Definition Multimedia Interface are trademarks or registered trademarks of HDMI Licensing LLC in the United States and other countries.
- HDAVI Control™ is a trademark of Panasonic Corporation.
- QuickTime and the QuickTime logo are trademarks or registered trademarks of Apple Inc., used under license therefrom.
- Adobe is a trademark or registered trademark of Adobe Systems Incorporated in the United States and/or other countries.
- Microsoft product screen shot(s) reprinted with permission from Microsoft Corporation.
- Other names, company names, and product names printed in these instructions are trademarks or registered trademarks of the companies concerned.

This product is licensed under the AVC patent portfolio license for the personal and non-commercial use of a consumer to (i) encode video in compliance with the AVC Standard ("AVC Video") and/or (ii) decode AVC Video that was encoded by a consumer engaged in a personal and non-commercial activity and/or was obtained from a video provider licensed to provide AVC Video. No license is granted or shall be implied for any other use. Additional information may be obtained from MPEG LA, LLC. See <http://www.mpegla.com>.



Pursuant to at the directive 2004/108/EC, article 9(2)
 Panasonic Testing Centre
 Panasonic Marketing Europe GmbH
 Winsbergring 15, 22525 Hamburg, Germany

VQT3A48
 F1010SM0

Panasonic Corporation
 Web Site: <http://panasonic.net>

© Panasonic Corporation 2010