

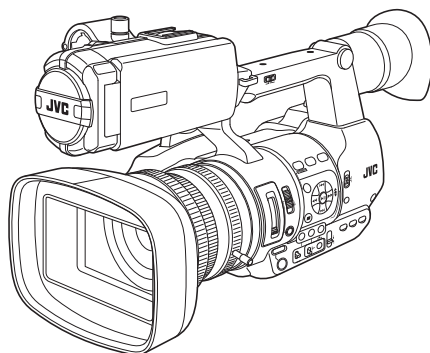

## HD MEMORY CARD CAMERA RECORDER

# GY-HM650U/GY-HM650E

## INSTRUCTIONS



The specifications and appearance of this product are subject to changes for further improvement without prior notice.

Please check the latest version of the INSTRUCTIONS from the following Mobile User Guide, or download the PDF from the URL below.

### Mobile User Guide

When you are outside, you can refer to the instructions from your Android phone or iPhone.

<http://manual3.jvckenwood.com/pro/mobile/global/>

You can view the Mobile User Guide using the browser on your Android phone or iPhone.



#### For Customer Use:

Enter below the Serial No. which is located on the body.  
Retain this information for future reference.

Model No. GY-HM650U  
Serial No. \_\_\_\_\_

#### Please read the following before getting started:

Thank you for purchasing this JVC product. Before operating this unit, please read the instructions carefully to ensure the best possible performance.

In this manual, each model number is described without the last letter (U/E) which means the shipping destination. (U: for USA and Canada, E: for Europe) Only "U" models (GY-HM650U) have been evaluated by UL.



**FOR USA**

These are general **IMPORTANT SAFEGUARDS** and certain items may not apply to all appliances.

<b>IMPORTANT SAFEGUARDS</b>
-----------------------------

1. Read these instructions.
2. Keep these instructions.
3. Heed all warnings.
4. Follow all instructions.
5. Do not use this apparatus near water.
6. Clean only with dry cloth.
7. Do not block any ventilation openings. Install in accordance with the manufacturer's instructions.
8. Do not install near any heat sources such as radiators, heat registers, stoves, or other apparatus (including amplifiers) that produce heat.
9. Protect the power cord from being walked on or pinched particularly at plugs, convenience receptacles, and the point where they exit from the apparatus.
10. Only use attachments/accessories specified by the manufacturer.
11. Use only with the cart, stand, tripod, bracket, or table specified by the manufacturer, or sold with the apparatus. When a cart is used, use caution when moving the cart/apparatus combination to avoid injury from tip-over.
12. Unplug this apparatus during lightning storms or when unused for long periods of time.
13. Refer all servicing to qualified service personnel. Servicing is required when the apparatus has been damaged in any way, such as power-supply cord or plug is damaged, liquid has been spilled or objects have fallen into the apparatus, the apparatus has been exposed to rain or moisture, does not operate normally, or has been dropped.

**INFORMATION (FOR CANADA)****RENSEIGNEMENT (POUR CANADA)**

This Class A digital apparatus complies with Canadian ICES-003.

Cet appareil numérique de la classe A est conforme à la norme NMB-003 du Canada.

**For USA-California Only**

This product contains a CR Coin Cell Lithium Battery which contains Perchlorate Material – special handling may apply.

See [www.dtsc.ca.gov/hazardouswaste/perchlorate](http://www.dtsc.ca.gov/hazardouswaste/perchlorate)

# Safety Precautions

## FOR USA AND CANADA



### CAUTION

RISK OF ELECTRIC SHOCK  
DO NOT OPEN



**CAUTION:**  
TO REDUCE THE RISK OF ELECTRIC SHOCK.  
DO NOT REMOVE COVER (OR BACK).  
NO USER-SERVICEABLE PARTS INSIDE. REFER SERVICING TO QUALIFIED SERVICE PERSONNEL.



The lightning flash with arrowhead symbol, within an equilateral triangle is intended to alert the user to the presence of uninsulated “dangerous voltage” within the product’s enclosure that may be of sufficient magnitude to constitute a risk of electric shock to persons.



The exclamation point within an equilateral triangle is intended to alert the user to the presence of important operating and maintenance (servicing) instructions in the literature accompanying the appliance.

This device complies with Part 15 of FCC Rules. Operation is subject to the following two conditions: (1) This device may not cause harmful interference, and (2) this device must accept any interference received, including interference that may cause undesired operation.

Changes or modifications not approved by JVC could void the user’s authority to operate the equipment. This equipment has been tested and found to comply with the limits for a Class A digital device, pursuant to Part 15 of the FCC Rules. These limits are designed to provide reasonable protection against harmful interference when the equipment is operated in a commercial environment.

This equipment generates, uses, and can radiate radio frequency energy and, if not installed and used in accordance with the instructions, may cause harmful interference to radio communications. Operation of this equipment in a residential area is likely to cause harmful interference in which case the user will be required to correct the interference at his own expense.

**POUR CANADA****ATTENTION**

RISQUE  
D'ELECTROCUTION  
NE PAS OUVRIR



**ATTENTION:**  
POUR EVITER TOUT RISQUE  
D'ELECTROCUTION NE PAS  
OUVRIR LE BOITIER. AUCUNE  
PIECE INTERIEURE N'EST A  
REGLER PAR L'UTILISATEUR. SE  
REFERER A UN AGENT QUALIFIE  
EN CAS DE PROBLEME.



Le symbole de l'éclair à l'intérieur d'un triangle équilatéral est destiné à alerter l'utilisateur sur la présence d'une "tension dangereuse" non isolée dans le boîtier du produit. Cette tension est suffisante pour provoquer l'électrocution de personnes.



Le point d'exclamation à l'intérieur d'un triangle équilatéral est destiné à alerter l'utilisateur sur la présence d'opérations d'entretien importantes au sujet desquelles des renseignements se trouvent dans le manuel d'instructions.

Ces symboles ne sont utilisés qu'aux Etats-Unis.

**CAUTION:**

The mains plug shall remain readily operable.

- Remove the mains plug immediately if the camera functions abnormally.

**WARNING:**

The battery pack, the camera with battery installed, and the remote control with battery installed should not be exposed to excessive heat such as direct sunlight, fire or the like.

**WARNING: TO PREVENT FIRE OR SHOCK HAZARD, DO NOT EXPOSE THIS UNIT TO RAIN OR MOISTURE.**

**AVERTISSEMENT : POUR EVITER LES RISQUES D'INCENDIE OU D'ELECTROCUTION, NE PAS EXPOSER L'APPAREIL A LA PLUIE NI A L'HUMIDITE.**

**NOTES:**

- The rating plate and safety caution are on the bottom and/or the back of the main unit.
- The serial number plate is on the bottom of the unit.
- The rating information and safety caution of the AC adapter are on its upper and lower sides.

**REMARQUES :**

- La plaque d'identification et l'avertissement de sécurité se trouvent sous l'appareil et/ou au dos.
- La plaque du numéro de série est située sur la partie inférieure de l'appareil.
- Les informations d'identification et l'avertissement de sécurité de l'adaptateur secteur sont situés sur ses côtés supérieur et inférieur.

**Caution on Replaceable lithium battery**

The battery used in this device may present a fire or chemical burn hazard if mistreated.

Do not recharge, disassemble, heat above 100°C (212°F) or incinerate.

Replace battery with Panasonic, Sanyo, Sony or Maxell CR2025.

Danger of explosion or risk of fire if the battery is incorrectly replaced.

- Dispose of used battery promptly.
- Keep away from children.
- Do not disassemble and do not dispose of in fire.

When the equipment is installed in a cabinet or on a shelf, make sure that it has sufficient space on all sides to allow for ventilation (10 cm (3-15/16") or more on both sides, on top and at the rear). Do not block the ventilation holes. (If the ventilation holes are blocked by a newspaper, or cloth etc. the heat may not be able to get out.) No naked flame sources, such as lighted candles, should be placed on the apparatus. When discarding batteries, environmental problems must be considered and the local rules or laws governing the disposal of these batteries must be followed strictly.

The apparatus shall not be exposed to dripping or splashing and that no objects filled with liquids, such as vases, shall be placed on the apparatus.

Do not point the lens directly into the sun. This can cause eye injuries, as well as lead to the malfunctioning of internal circuitry. There is also a risk of fire or electric shock.

### **CAUTION!**

The following notes concern possible physical damage to this unit and to the user.

Carrying or holding this unit by the LCD monitor can result in dropping the unit, or in a malfunction.

Do not use a tripod on unsteady or unlevel surfaces. It could tip over, causing serious damage to the unit.

### **CAUTION!**

Connecting cables (Audio/Video, etc.) to this unit and leaving it on top of the TV is not recommended, as tripping on the cables will cause the unit to fall, resulting in damage.

### **When using the AC adapter in areas other than the USA**

The provided AC adapter features automatic voltage selection in the AC range from 110 V to 240 V.

### **USING HOUSEHOLD AC PLUG ADAPTER**

In case of connecting the unit's power cord to an AC wall outlet other than American National Standard C73 series type, use an AC plug adapter called a "Siemens Plug" as shown.

For this AC plug adapter, consult your nearest JVC dealer.

### **Plug Adapter**

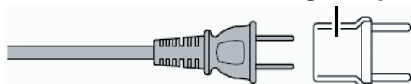

- Remove the AC adapter from the AC wall outlet when not in use.
- Do not leave dust or metal objects adhered to the AC wall outlet or AC adapter (power/DC plug).

**IMPORTANT (for owners in the U.K.)****Connection to the mains supply in the United Kingdom.****DO NOT cut off the mains plug from this equipment.**

If the plug fitted is not suitable for the power points in your home or the cable is too short to reach a power point, then obtain an appropriate safety approved extension lead or consult your dealer.

**BE SURE** to replace the fuse only with an identical approved type, as originally fitted, and to replace the fuse cover.

If nonetheless the mains plug is cut off be sure to remove the fuse and dispose of the plug immediately, to avoid possible shock hazard by inadvertent connection to the mains supply.

If this product is not supplied fitted with a mains plug then follow the instructions given below:

**DO NOT** make any connection to the Larger Terminal coded E or Green.

The wires in the mains lead are coloured in accordance with the following code:

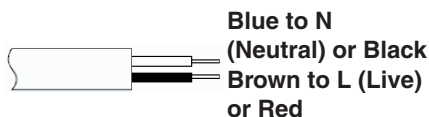

If these colours do not correspond with the terminal identifications of your plug, connect as follows:

Blue wire to terminal coded N (Neutral) or coloured black.

Brown wire to terminal coded L (Live) or coloured Red.

If in doubt — consult a competent electrician.

**CAUTIONS:**

- To prevent shock, do not open the cabinet. No user serviceable parts inside.  
Refer servicing to qualified personnel.
- When you are not using the AC adapter for a long period of time, it is recommended that you disconnect the power cord from AC outlet.

**FOR EUROPE**

This equipment is in conformity with the provisions and protection requirements of the corresponding European Directives.

This equipment is designed for professional video appliances and can be used in the following environments:

- Controlled EMC environment (for example, purpose-built broadcasting or recording studio), and rural outdoors environments.

In order to keep the best performance and furthermore for electromagnetic compatibility we recommend to use cables not exceeding the following lengths:

Port	Cable	Length
DC INPUT	Exclusive Cable	1.8 m
USB Mini	Shielded Cable	3 m
AV OUT	Exclusive Cable	1.5 m
HDMI	Shielded Cable	3 m
REMOTE	Exclusive Cable	1 m
HD/SD SDI	Coaxial Cable	10 m
AUDIO INPUT 1/2	Shielded Cable	3 m
HEADPHONE	Exclusive Cable	3 m
AUX	Shielded Cable	5 m
TC	Shielded Cable	5 m

The inrush current of this apparatus is 4.9 A.

**CAUTION:**

Where there are strong electromagnetic waves or magnetism, for example near a radio or TV transmitter, transformer, motor, etc., the picture and the sound may be disturbed. In such case, please keep the apparatus away from the sources of the disturbance.

**Dear Customer,**

This apparatus is in conformance with the valid European directives and standards regarding electromagnetic compatibility and electrical safety. European representative of JVC KENWOOD Corporation is: JVC Technical Services Europe GmbH Postfach 10 05 04 61145 Friedberg Germany

**Sehr geehrter Kunde, sehr geehrte Kundin,**

dieses Gerät stimmt mit den gültigen europäischen Richtlinien und Normen bezüglich elektromagnetischer Verträglichkeit und elektrischer Sicherheit überein. Die europäische Vertretung für die JVC KENWOOD Corporation ist: JVC Technical Services Europe GmbH Postfach 10 05 04 61145 Friedberg Deutschland

**CAUTION:**

To avoid electric shock or damage to the unit, first firmly insert the small end of the power cord into the AC Adapter until it is no longer wobbly, and then plug the larger end of the power cord in to an AC outlet.

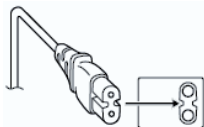
**FOR EUROPEAN****WARNING**

This is a Class A product. In a domestic environment this product may cause radio interference in which case the user may be required to take adequate measures.

**Information for Users on Disposal of Old Equipment and Batteries****Products****Battery****Notice:**

The sign Pb below the symbol for batteries indicates that this battery contains lead.

**[European Union]**

These symbols indicate that the electrical and electronic equipment and the battery with this symbol should not be disposed of as general household waste at its end-of-life.

Instead, the products should be handed over to the applicable collection points for the recycling of electrical and electronic equipment as well as batteries for proper treatment, recovery and recycling in accordance with your national legislation and the Directive 2002/96/EC and 2006/66/EC.

By disposing of these products correctly, you will help to conserve natural resources and will help to prevent potential negative effects on the environment and human health which could otherwise be caused by inappropriate waste handling of these products.

For more information about collection points and recycling of these products, please contact your local municipal office, your household waste disposal service or the shop where you purchased the product.

Penalties may be applicable for incorrect disposal of this waste, in accordance with national legislation.

**(Business users)**

If you wish to dispose of this product, please visit our web page <http://www.jvc.eu> to obtain information about the take-back of the product.

**[Other Countries outside the European Union]**

These symbols are only valid in the European Union.

If you wish to dispose of these items, please do so in accordance with applicable national legislation or other rules in your country for the treatment of old electrical and electronic equipment and batteries.

## Battery Pack

The supplied battery pack is a lithium-ion battery. Before using the supplied battery pack or an optional battery pack, be sure to read the following cautions:

### • To avoid hazards **Terminals**

... **do not** burn.

... **do not** short-circuit the terminals. Keep it away from metallic objects when not in use.

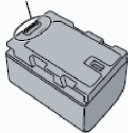

When transporting, carry the battery in a plastic bag.

... **do not** modify or disassemble.

... **do not** expose the battery to temperatures exceeding 60°C (140°F), as this may cause the battery to overheat, explode or catch fire.

... use only specified chargers.

### • To prevent damage and prolong service life

... do not subject to unnecessary shock.

... charge within the temperature range of 10°C to 35°C (50°F to 95°F). Cooler temperatures require longer charging time, or in some cases stop charging at all. Warmer temperatures prevent complete charging, or in some cases stop charging at all.

... store in a cool, dry place. Extended exposure to high temperatures will increase natural discharge and shorten service life.

... keep a 30% battery level (  ) if the battery pack is not to be used for a long period of time.

In addition, fully charge and then fully discharge the battery pack every 6 months, then continue to store it at a 30% battery level (  ).

... remove from charger or powered unit when not in use, as some machines use current even when switched off.

... do not drop or subject to strong impact.

# Contents

## Introduction

Safety Precautions .....	4
Contents .....	10
Main Features .....	12
Precautions for Proper Use .....	14
Operation Modes .....	18
Names of Parts .....	20
Side Control Panel .....	22
SD Slot .....	23
Rear Terminal .....	23
LCD Monitor .....	24
Lens Section .....	25
Basic System Diagram .....	26

## Preparations

Settings and Adjustments Before Use .....	27
Adjusting the Grip Belt .....	27
Attaching an External Microphone .....	27
Attaching the Tripod .....	27
Attaching the Large Eyecup .....	27
Opening/Closing the Lens Cover .....	28
Attaching/Detaching the Hood .....	28
Power Supply .....	28
Using a Battery Pack .....	28
Using AC Power (DC IN Power) .....	30
Power Status Display .....	30
Turning On/Off the Power .....	31
Initial Settings .....	32
Displays on the LCD Monitor and Viewfinder ..	34
Display Screen .....	34
Status Screen .....	35
USB Mode Screen .....	35
Remote Edit Mode Screen .....	35
Warning Display .....	35
Adjusting the LCD Monitor and Viewfinder .....	36
Adjusting the LCD Monitor .....	36
Adjusting the Viewfinder .....	37
Assigning Functions to User Buttons .....	38
Tally Lamp .....	38
SD Card .....	39
Usable Cards .....	39
Formatting (Initializing) SD Cards .....	41
Restoring the SD Card .....	42
Clips Recorded to SD Cards .....	43

## Shooting

Basic Shooting Procedures .....	44
Selecting System Definition, File Format and Video Format .....	45
Zoom Operation .....	47
Focus Operation .....	48
Adjusting the Focusing by Face Detection .....	50

Adjusting the Brightness .....	51
Adjusting the Iris .....	52
Setting the Gain .....	53
Setting the Electronic Shutter .....	54
Setting the ND Filter .....	56
Adjusting the White Balance .....	56
Adjusting the Camera Image .....	60
Using the Image Stabilizer .....	60
Audio Recording .....	61
Monitoring Audio Sound During Recording Using a Headphone .....	63
Time Code and User's Bit .....	64
Setting Time Code Generator .....	65
Synchronizing Time Code on Another Camera .....	68
Setting Zebra Pattern .....	69
Setting Spot Meter .....	70
Acquiring Positioning Information by GPS .....	72
Viewing Recorded Videos Immediately (Clip Review) .....	72
Recording Simultaneously at Two Different Definitions .....	73
Splitting the Clips Freely (Clip Cutter Trig) .....	74
Dual Rec .....	74
Backup Rec .....	76
Special Recording .....	78
Pre Rec .....	78
Clip Continuous Rec .....	78
Frame Rec .....	80
Interval Rec .....	81
Variable Frame Rec .....	82

## Playback

Playing Recorded Clips .....	83
Thumbnail Screen .....	83
Actions .....	85
Playing back .....	86
Deleting Clips .....	87
Appending/Deleting OK Mark .....	88
Selecting and Performing Operations on Multiple Clips .....	89
Selecting Multiple Clips Randomly .....	89
Selecting Multiple Clips Consecutively .....	90

## Menu Display and Detailed Settings

Basic Operations in Menu Screen .....	91
Display and Description of the Menu Screen .....	92
Text Input with Software Keyboard .....	93
Menu Screen Hierarchical Chart .....	94
Camera Function Menu .....	95
User Switch Set Item .....	97
Camera Process Menu .....	98
Detail/Adjust Item .....	101
White Balance Item .....	102
TC/UB Menu .....	102

LCD/VF Menu .....	103	Clip Metadata .....	148
Shooting Assist Item .....	104	View Remote Feature .....	150
Marker Settings Item .....	105	Operating Procedure .....	150
Display Settings Item .....	105	Registering/Deleting Preset Zoom .....	151
A/V Set Menu .....	107	Configuring Settings via a Browser .....	152
Video Set Item .....	107	Changing View Remote Function Settings .....	153
Audio Set Item .....	107	Changing Connection Setup .....	154
System Menu .....	110	Changing Metadata Server Settings .....	155
Record Set Item .....	111	Changing Clip Server Settings .....	155
Settings Item .....	115	Managing the Network Connection Settings File .....	156
Adding/Editing Frequently Used Menu Items (Favorites Menu) .....	117	Saving the Connection Settings File .....	156
Adding Menu Items to Favorites Menu .....	117	Reading the Connection Settings File .....	157
Editing Favorites Menu .....	118	Deleting Connection Settings .....	158
<b>Display/Status Screen</b>		<b>Others</b>	
Display Screen in Camera Mode .....	121	Error Messages and Actions .....	159
Display Screen in Media Mode .....	126	List of FTP Transfer Errors .....	161
Status Screen .....	128	Tally Lamp .....	162
<b>Camera Features</b>		Warning Tone .....	162
Marker and Safety Zone Displays (Camera Mode Only) .....	129	Troubleshooting .....	163
Smoothing the Skin Color (Skin Detail Function) .....	129	Specifications .....	165
Color Bar Output .....	129	Index .....	168
Adjusting Color Matrix .....	130		
Configuring Setup Files .....	131		
Saving Setup Files .....	131		
Loading a Setup File .....	132		
Deleting Setup Files .....	133		
<b>Connecting External Devices</b>			
Managing/Editing Clips on a PC .....	134		
Connecting External Monitor .....	135		
Connecting the Headphone .....	137		
Connecting Wired Remote Control .....	137		
<b>Connecting to the Network</b>			
Functions of Network Connection .....	138		
Preparing Network Connection .....	138		
Operating Environment .....	138		
Camera Setup for Network Connection .....	139		
Connecting via Wireless LAN .....	139		
Connecting via Wired LAN .....	141		
Connecting via 3G Adapter .....	141		
Importing Metadata .....	142		
Preparing Metadata .....	142		
Configuring the Server for Downloading .....	142		
Importing Metadata .....	143		
Uploading a Recorded Video Clip .....	144		
Configuring the FTP Server for Uploading .....	144		
Uploading Video Clip .....	144		
Connecting via a Browser .....	146		
Editing Metadata .....	147		
Planning Metadata .....	147		

# Main Features

## F11 Sensitivity, 1/3-inch Full HD 3CMOS Sensors

This camera recorder is equipped with three 1/3-inch 2.07M pixels full HD CMOS sensors. It delivers high image quality, high color resolution through processing of individual R, G, B color signals. 12-bit signal processing and the new 2D DNR removes dark current and optical shot noise without losing S/N and high resolution, thereby achieving high F11 sensitivity.

## New Fujinon 23x Zoom Lens

It ensures high magnification of 29 mm at wide ends, and provides high sensitivity across all regions with F1.6-3.0. The zoom ring with zoom ring pin enables zooming from the wide end to the tele end in 90 degrees. Focus and iris control are also possible using separate rings.

## Small, Lightweight, Stylish, and Ergonomic Design

The camera recorder is only 2.5 kg in operation mode. It is light and easy to use. Its ergonomic design takes into consideration portability and operability and is easy on the hand during shooting.

## JVC's Proprietary FALCONBRID High-Quality Imaging Engine

The FALCONBRID high-quality imaging engine omits unnecessary processing through incorporating camera processing and image compression on a single chip. Images from imaging devices are compressed and processed without any loss thereby achieving high-quality images.

## MPEG2 and H.264 Codec

FALCONBRID allows users to select MPEG-2 and AVCHD, the most commonly used codec for professional video, as the recording format.

## QuickTime (MPEG-2 HD/H.264 HD/H.264 SD)/MP4 (MPEG-2 HD)/AVCHD File Formats

Inheriting the concept of ProHD memory camera recorders, this camera recorder can support various file formats, such as AVCHD and QuickTime (H.264 SD) files, in addition to QuickTime (MPEG-2 HD/H.264 HD) files that can be directly edited on Apple Final Cut Pro and MP4 files that are most suitable for XDCAM EX Nonlinear Editing Workflow.

## Two SDHC/SDXC Card Slots for Dual, Backup and Series Recording

The most common SDHC/SDXC card recording system is used as the memory card. This ensures reliability and operation at low running cost. Various user friendly recording systems are also available. These include dual recording of the same file to two cards, and using REC/STBY to break up video clips in one card while performing backup recording to the other card.

## Diverse Simultaneous Recording Combinations (HD and SD, HD and Proxy Video, etc.)

This camera recorder comes with a convenient proxy video (480x270 30p/25p/24p, 1.2 Mbps, MOV) recording function for distribution over the network. With the Dual Rec feature further enhanced, you can now record videos in the HD quality on one SDHC/SDXC card, while at the same time record to the other card in the SD or proxy video quality.

## Variable Frame Rec

Enables beautiful slow motion and quick motion image recording such as overcrank and undercrank.

## SDI/HDMI Simultaneous Output

Equipped with both [HD/SD SDI] and [HDMI] terminals as digital output. Non-compressed full HD video signals and audio signals can be output to the [HD/SD SDI] and [HDMI] terminals at the same time.

## **Auto Focus/Optical Image Stabilizer**

The camera recorder is equipped with a face detection auto focus function that covers the entire screen.

It can switch to manual focus as well.

A built-in optical image stabilizer feature is also available.

## **Professional Switch Layout and Various Video Parameter Settings**

Switches for Gain and White Balance are available on the side panel to enable quick switchings according to the shooting scene.

Image parameters such as gamma and color matrixes are also available in the menu for adjusting preferred tones.

## **4-position ND Filter**

This camera recorder incorporates three types of ND filters.

Adjust the amount of light according to the brightness during shooting by switching the 4-position ND filter (OFF, 1/4, 1/16, 1/64).

## **0.45-inch 1.22M Pixel Color Viewfinder, 3.5-inch 920K Pixel LCD Display (Equipped with Focus Assist Function)**

## **Built-in Stereo Microphone, 2-channel XLR Audio Input (Microphone/Line Switch, Phantom Power Supply) and Mini Jack Input Terminal for Wireless Microphone Receiver**

## **Pre Rec Function (Up to 15 Seconds) and Interval Rec Function**

## **Supports Wired Remote Control**

## **35 Mbps High-quality Recording Mode**

This camera recorder is equipped with a 35 Mbps mode for the MPEG-2 (MOV, MP4, MXF) and H.264 (MOV) file formats to support recording in high image quality.

## **Built-in GPS**

This camera recorder is equipped with a GPS function. Position information obtained from the GPS satellite can be recorded as metadata during shooting.

## **Diverse Wireless Communications Functions**

This camera recorder supports various operations via a mobile device, such as remote control, viewing, metadata transmission, and transfer of proxy files as an FTP client.

Equipped with a USB host function, you can upload files recorded in this camera recorder via the network by connecting it to the optional wireless LAN adapter or other network devices.

## **Application Software Provided**

The [JVC ProHD Clip Manager] application software is provided for you to copy recorded clips to Windows or Macintosh computers and for checking the video images. (For MP4 file format)

The disc provided with this camera recorder comes with [JVC ProHD Clip Manager] and other application software as well as their user guides.

\* For details, refer to the user guides for each application software.

**Symbols used**

- Caution** : Describes precautions concerning the operation of this product.
- Memo** : Describes reference information, such as functions and usage restrictions of this product.
-  : Indicates the reference page numbers and reference items.

**Content of this manual**

- Illustrated designs, specifications and other contents of this manual are subject to change for improvement without prior notice.
- AVCHD and the AVCHD logo are trademarks of Panasonic Corporation and Sony Corporation.
- XDCAM EX is a trademark of Sony Corporation.
- SDXC and SDHC logos are trademarks of SD-3C, LLC.
- HDMI (High-Definition Multimedia Interface) and  are trademarks of HDMI Licensing, LLC.
- QuickTime, Final Cut Pro, iPhone, iPad, iPod touch, iOS, Mac OS and Safari are trademarks of Apple Inc., registered in the U.S. and other countries.
- Android and Google Chrome are trademarks and/or registered trademarks of Google Inc.
- QR Code is a registered trademark of Denso Wave Incorporated.
- Dolby and the double-D symbol are trademarks of Dolby Laboratories.
- Microsoft, Windows, Windows XP, Windows Vista, Windows 7 and Internet Explorer are either registered trademarks or trademarks of Microsoft Corporation in the United States and/or other countries.
- Mozilla and Firefox are either trademarks or registered trademarks of Mozilla Foundation in the United States and/or other countries.
- Intel Core 2 Duo is a trademark or registered trademark of Intel Corporation or its subsidiaries in the United States and other countries.
- Other product and company names included in this instruction manual are trademarks and/or registered trademarks of their respective companies. Marks such as <sup>TM</sup> and ® have been omitted in this manual.

# Precautions for Proper Use

## | Storage and Usage Locations

- Allowable ambient temperature and humidity  
Be sure to use this unit within the allowable temperature range of 0 °C to 40 °C (32 °F to 104°F) and a relative humidity of 30 % to 80 %. Using this unit at a temperature or humidity outside the allowable ranges could result not only in malfunction but also serious impact on the CMOS elements as small white spots may be generated. Please exercise care during use.
- Strong electromagnetic waves or magnetism  
Noise may appear in the picture or audio and/or the colors may be incorrect if this unit is used near a radio or television transmitting antenna, in places where strong magnetic fields are generated by transformers, motors, etc., or near devices emitting radio waves, such as transceivers or cellular phones.
- Use of wireless microphone near this unit  
When a wireless microphone or wireless microphone tuner is used near this unit during recording, the tuner could pick up noise.
- Avoid using or placing this unit in the following places.
  - Places subject to extreme heat or cold
  - Places with excessive dirt or dust
  - Places with high humidity or moisture
  - Places subject to smoke or vapor such as near a cooking stove
  - Places subject to strong vibrations or unstable surfaces
  - In a parked car under direct sunlight or near a heater for long hours
- Do not place this unit at places that are subject to radiation or X-rays, or where corrosive gases occur.
- Protect this unit from being splashed with water. (Especially when shooting in the rain)
- Protect this unit from getting wet when shooting on a beach. In addition, salt and sand may adhere to the body. Be sure to clean the unit after use.
- Protect this unit against penetration of dust when using it in a place subject to sandy dust.

## Transportation

Do not drop or hit this unit against a hard object when transporting.

## Power Saving

When this unit is not in use, be sure to set the [POWER ON/OFF(CHG)] switch to "OFF(CHG)" in order to reduce power consumption.

## Maintenance

- Turn off the power before performing any maintenance.
- Wipe the external cabinet of the unit with a soft cloth. Do not wipe the body with benzene or thinner. Doing so may cause the surface to melt or turn cloudy. When it is extremely dirty, soak the cloth in a solution of neutral detergent, wipe the body with it, and then use a clean cloth to remove the detergent.

## Rechargeable Battery

- Be sure to use only the specified batteries. We do not guarantee the safety and performance of this device if an unspecified battery is used.
- The battery is not charged when purchased.
- When using the battery in a low temperature environment (10°C/50 °F or below), the operating time may be shortened, or it may not function properly. When using the device outdoors in the winter weather, warm the battery, such as by placing it in the pocket, before attaching it.
- Do not expose the battery to excessive heat, such as direct sunlight or fire.
- If the battery is not to be used for a long time
  - Use up the charge completely and detach it from the camera to prevent deterioration. (Wait for the battery to run out by itself such as through continuous shooting or playback.)
  - Charge the battery once every half a year, and store it again after using up the charge.
- Store the removed battery in a dry place between 15 °C and 25 °C (59 °F and 77 °F).

### ATTENTION:



The product you have purchased is powered by a rechargeable battery that is recyclable. Please call 1-800-8-BATTERY for information on how to recycle this battery.

## Regular Inspection (Maintenance)

Under normal environment, dust will accumulate on the camera recorder when it is used over a long period. Dust may enter the camera recorder especially if it is used outdoors. This may affect the image and sound quality of the camera recorder. Check and replace the fan after every 9000 hours (suggested guideline).

You can check the usage time of the fan in [System] → [System Information] → [Fan Hour].

(☞ P111 [ Fan Hour ] )

If the fan is used for more than 9000 hours without replacement, "FAN MAINTENANCE REQUIRED" will be displayed every time you turn on the power.

## SDHC/SDXC Cards

- SDHC/SDXC card is referred to as "SD card" in this manual.
- This camera recorder saves the recorded images and audio sound on the SD card (sold separately) in the card slot.
- Use an SD card (4 GB to 128 GB) with Class 6 or higher performance, formatted using this camera recorder.
- Depending on the recording format, SD card with Class 4 or higher performance can also be used. (☞ P45 [Selecting System Definition, File Format and Video Format] )

\* Using cards other than those from Panasonic, TOSHIBA or SanDisk may result in recording failure or data loss.

■ If the SD card contains files recorded by devices other than this camera recorder or files that are saved from a PC, the recordable time may be shorter or data may not be properly recorded. In addition, the remaining space on the card may not increase even when files are deleted using a PC.

## Handling of SD Cards

- The status indicator lights up in red when data on the SD card is being accessed. Do not remove the SD card during data access (such as recording, playback, or formatting). Do not turn off the power or remove the battery and AC adapter during access either.
- Do not use or store the SD card in a place that is subject to static electricity or electrical noise.
- Do not place the SD card near locations that are exposed to strong magnetic fields or radio waves.
- Inserting the SD card incorrectly may result in damage of this unit or the SD card.

■ We are not liable for any accidental loss of data stored on the SD card. Please back up any important data.

■ Make use of the SD card within the prescribed conditions of use.

Do not use it at the following locations.

Places that are subject to direct sunlight, high humidity or corrosion, places near thermal equipment, sandy or dusty places, or in a car under the sun with the doors and windows closed.

■ Do not bend or drop the SD card, or subject it to strong impact or vibration.

■ Do not splash the SD card with water.

■ Do not dismantle or modify the SD card.

■ Do not touch the terminals with your hands or with a metal object.

■ Do not allow dust, dirt, water, or foreign objects to adhere to the terminals.

■ Do not remove the labels or stick other labels or stickers on the SD cards.

■ Do not use pencils or ballpoint pens to write on the SD cards. Always use oil-based pens.

■ If you format (initialize) the SD card, all data recorded on the card, including video data and setup files, will be deleted.

■ You are recommended to use cards that are formatted (initialized) on this camera recorder.

- The SD card may be damaged if the camera recorder is not operated correctly. Formatting (initializing) the SD card may allow it to operate correctly.

- SD cards that have been formatted (initialized) on other cameras, computers or peripheral equipment may not operate correctly. In this case, format (initialize) the SD card on this camera recorder.

■ If you want to wipe out all information by completely erasing the data, we recommend either using commercially available software that is specially designed for that purpose, or by physically destroying the SD card with a hammer, etc. When formatting or erasing data using the camera recorder, only the file administration information is changed. The data is not completely erased from the SD card.

■ Some commercially available SD cards may be harder to be removed from this unit. Remove them by hooking onto the groove on the cards.

- It will be easier to remove the cards after several times.

- Do not stick any stickers on the cards.



Groove

■ The SD card may pop out when it is being removed. Be careful not to lose the card.

## Others

■ Do not insert objects other than the memory card into the card slot.

■ Do not block the vent on the unit.

Blocking of the vent causes internal heating and may lead to burns and fires.

■ Do not turn off the [POWER ON/OFF(CHG)] switch or remove the power cable during recording or playback.

■ The camera recorder may not show stable pictures for a few seconds immediately after the power is turned on, but this is not a malfunction.

■ When the video signal output terminals are not in use, put on the covers to prevent damage to the terminals.

■ Do not drop this unit or subject it to strong impact or vibration as it is a precision equipment.

■ Optical performance of lens

Due to the optical performance of the lens, color divergence phenomena (magnification chromatic aberration) may occur at the periphery of the image. This is not a camera malfunction.

■ Noise may appear in the image when switching modes.

■ If placed on its side, heat release efficiency will deteriorate.

■ Use the supplied AC adapter as the power supply. Do not use the supplied AC adapter on other devices.

■ When the connectors that come with connector covers are not in use, put on the covers to prevent damage to the connectors.

## About GPS

- The GPS (Global Positioning System) satellites are managed by the Department of State of the U.S., and its precision may be altered intentionally.
- Perform positioning at an unobstructed location with a clear view that is not indoors or blocked by trees.
- The time needed for obtaining the position information may be longer and variation may also be larger depending on the surrounding environment and time of day.
- This camera recorder uses the WGS 84 World Geodetic System.
- Signal from GPS satellites may be interrupted by communication signal from electronic devices such as mobile phones.

## LCD Monitor and Viewfinder

- The LCD monitor and viewfinder screen are manufactured using high-precision technology. Black spots may appear on the LCD monitor and viewfinder screen, or red, blue, and/or white spots may not disappear. However, this is not a malfunction and these spots are not recorded on the SD card.
- If you use this unit continuously for a long period of time, the characters displayed in the viewfinder may temporarily remain on the screen. This is not recorded on the SD card. They will not appear after you turn the power off and then on again.
- If you use this unit in a cold place, the images may appear to lag on the screen, but this is not a malfunction. Retained images are not recorded on the SD card.
- Do not press against the surface with force or subject it to strong impact. Doing so may damage or break the screens.
- Noise may appear in the viewfinder when switching between the live video and playback images.
- Due to the characteristic of the viewfinder display device, colors may appear on the images when you blink your eyes. It does not affect the recorded images, SDI output, or HDMI output.

## Copyright

Any recordings made on this camera recorder that are played back for profit or public preview may infringe on the rights of the owner of the recordings. Do not use the recordings for purpose other than personal enjoyment without prior consent from the owner.

## License Notices

■ **MPEGLA AVC**  
THIS PRODUCT IS LICENSED UNDER THE AVC PATENT PORTFOLIO LICENSE FOR THE PERSONAL USE OF A CONSUMER OR OTHER USES IN WHICH IT DOES NOT RECEIVE REMUNERATION TO (i) ENCODE VIDEO IN COMPLIANCE WITH THE AVC STANDARD (“AVC VIDEO”) AND/OR (ii) DECODE AVC VIDEO THAT WAS ENCODED BY A CONSUMER ENGAGED IN A PERSONAL ACTIVITY AND/OR WAS OBTAINED FROM A VIDEO PROVIDER LICENSED TO PROVIDE AVC VIDEO. NO LICENSE IS GRANTED OR SHALL BE IMPLIED FOR ANY OTHER USE. ADDITIONAL INFORMATION MAY BE OBTAINED FROM MPEG LA, L.L.C. SEE

[HTTP://WWW.MPEGLA.COM](http://www.mpegla.com)

■ **MPEGLA MPEG-2 Patent**  
ANY USE OF THIS PRODUCT IN ANY MANNER OTHER THAN PERSONAL USE THAT COMPLIES WITH THE MPEG-2 STANDARD FOR ENCODING VIDEO INFORMATION FOR PACKAGED MEDIA IS EXPRESSLY PROHIBITED WITHOUT A LICENSE UNDER APPLICABLE PATENTS IN THE MPEG-2 PATENT PORTFOLIO, WHICH LICENSE IS AVAILABLE FROM MPEG LA, LLC, 6312 S. Fiddlers Green circle, Suite 400E, Greenwood Village, Colorado 80111 U.S.A.

## Encryption in Network Connection

Wireless LAN connections make use of an encryption function. This encryption is designed for commercially-sold equipment, and it cannot be altered.

# Operation Modes

This camera recorder has four operation modes - Camera mode, Media mode, USB mode and Remote Edit mode.

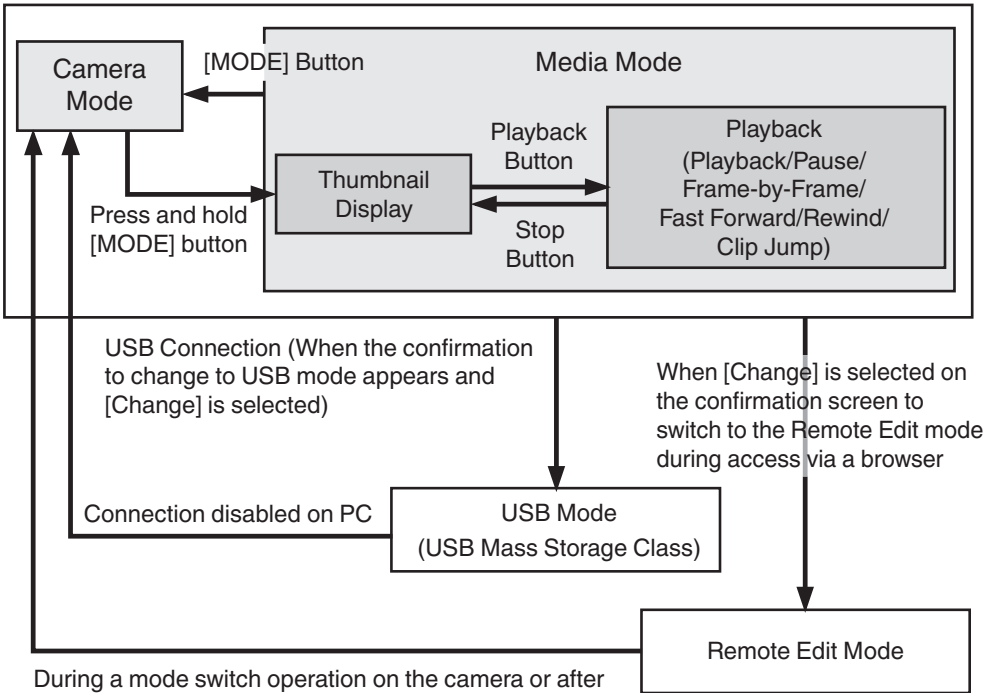

During a mode switch operation on the camera or after ending the editing of clip metadata at the terminal

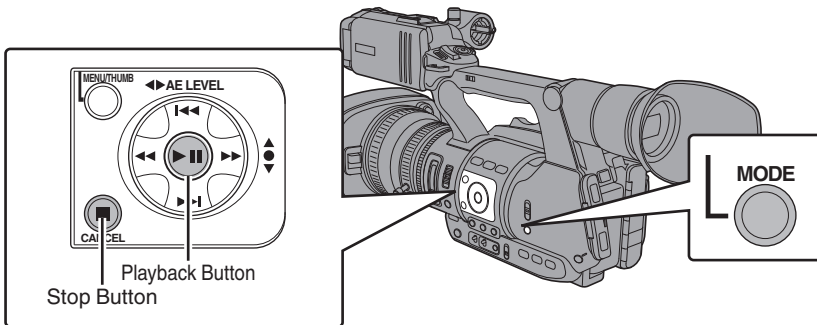

Operation Mode	Description
Camera Mode	<ul style="list-style-type: none"> <li>• This is the camera shooting mode. The camera recorder starts up in Camera mode when the power is turned on.</li> <li>• Camera images are output on the viewfinder and LCD monitor. When a recordable SD card is inserted, the camera recorder enters the recording standby mode. "STBY" appears on the operation mode display area of the LCD monitor and viewfinder.</li> <li>• Press the [REC] trigger button to start recording.</li> </ul> <p>Memo : _____</p> <ul style="list-style-type: none"> <li>• Playback of SD card is not possible in Camera mode. However, you can check the most recently recorded video clip. (☞ P72 [Viewing Recorded Videos Immediately (Clip Review)] )</li> </ul>
Media Mode	<ul style="list-style-type: none"> <li>• This mode allows you to play back or delete clips recorded on the SD card.</li> <li>• When a playable SD card is inserted, the thumbnail or playback screen is displayed on the viewfinder and LCD monitor.</li> <li>• Press the [MODE] selection button to enter Media mode when you are not shooting in Camera mode. Once the camera recorder is in Media mode, thumbnails of the selected media slot are displayed.</li> </ul>
USB Mode	<ul style="list-style-type: none"> <li>• This mode allows you to connect to a PC and transfer the files on an SD card to the PC.</li> <li>• When the camera recorder is connected to a USB cable, the message "Change to USB Mode?" appears. Select [Change] and press the Set button to switch to USB mode. (☞ P134 [Managing/Editing Clips on a PC] )</li> <li>• In USB mode, the camera recorder is recognized by the connected PC as a peripheral drive. (USB mass storage class only) Disable the connection on the PC and remove the USB cable from the camera recorder to switch to Camera mode. (☞ P134 [Managing/Editing Clips on a PC] )</li> </ul> <p>Memo : _____</p> <ul style="list-style-type: none"> <li>• When a USB cable is connected during recording, the message appears after recording stops.</li> <li>• If playback is in progress, the message appears once the files are closed automatically, such as when playback stops.</li> <li>• Files on the PC cannot be written to the SD card.</li> </ul>
Remote Edit Mode	<ul style="list-style-type: none"> <li>• This is a mode for accessing the page for editing the metadata that is recorded in a clip via a browser on devices such as a smartphone, tablet terminal, or PC.</li> <li>• When you access via a browser on devices such as a smartphone, tablet terminal, or PC, a "Change to Remote Edit Mode?" message will appear on the display screen of the camera recorder. Select [Change], and press the Set button to switch to the Remote Edit mode for editing the clip's metadata. (☞ P148 [ Clip Metadata ] )</li> </ul> <p>Memo : _____</p> <ul style="list-style-type: none"> <li>• If you access via a browser on devices such as a smartphone, tablet terminal, or PC while recording is in progress, the message appears after recording stops.</li> <li>• If playback is in progress, the message appears once the files are closed automatically, such as when playback stops.</li> </ul>

# Names of Parts

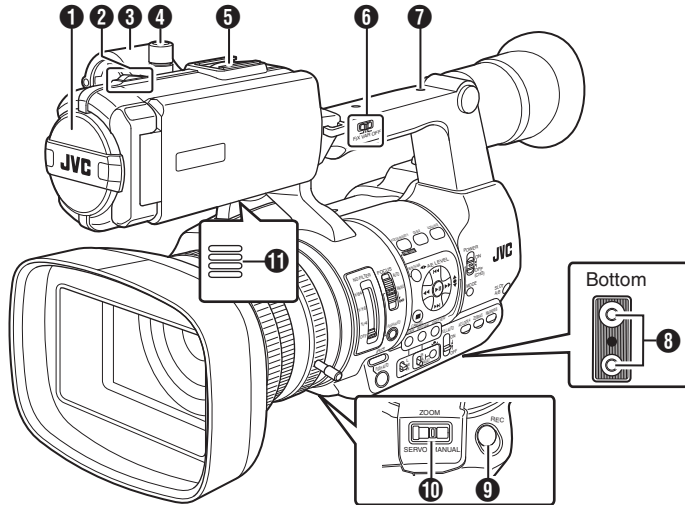

- 1** Built-in Microphone  
(☞ P61 [Audio Recording] )
  - 2** Tally Lamp  
(☞ P38 [Tally Lamp] )  
(☞ P162 [Tally Lamp] )
  - 3** Microphone Holder  
(☞ P27 [Attaching an External Microphone] )
  - 4** Microphone Holder Lock Knob  
(☞ P27 [Attaching an External Microphone] )
  - 5** Shoe  
For mounting separately sold lights and accessories.
  - 6** [FIX/VAR/OFF] Zoom Speed Switch  
(☞ P47 [Zoom Operation] )  
For switching the zoom speed of the zoom lever **27** at the handle.
  - 7** Accessory Mounting Screw Hole
  - 8** Tripod Mounting Hole  
(☞ P27 [Attaching the Tripod] )
  - 9** [REC] Record Trigger Button  
Starts/stops recording.
  - 10** [ZOOM SERVO/MANUAL] Zoom Operation Servo/Manual Switch  
Set to "SERVO" when using the zoom lever at the grip **20** or the zoom lever at the handle **27**.  
(☞ P47 [Zoom Operation] )
  - 11** Monitor Speaker  
(☞ P86 [Audio Output during Playback] )
  - 12** Viewfinder  
(☞ P36 [Adjusting the LCD Monitor and Viewfinder] )
  - 13** Visibility Adjustment Lever  
(☞ P36 [Adjusting the LCD Monitor and Viewfinder] )
  - 14** Eyecup  
Prevents external light from entering the viewfinder screen and cameraman's vision.  
(☞ P27 [Attaching the Large Eyecup] )
  - 15** Battery  
(☞ P28 [Using a Battery Pack] )
  - 16** [ ] Headphone Jack (Φ3.5 mm)  
(☞ P63 [Monitoring Audio Sound During Recording Using a Headphone] )
  - 17** [AUX] AUX Input Terminal (Φ3.5 mm)  
For connecting to receiver such as wireless microphone.
- Memo : \_\_\_\_\_
- This button is interlocked with the [REC] button **13** on the grip and the [REC/HOLD] button **26** at the top of the handle.

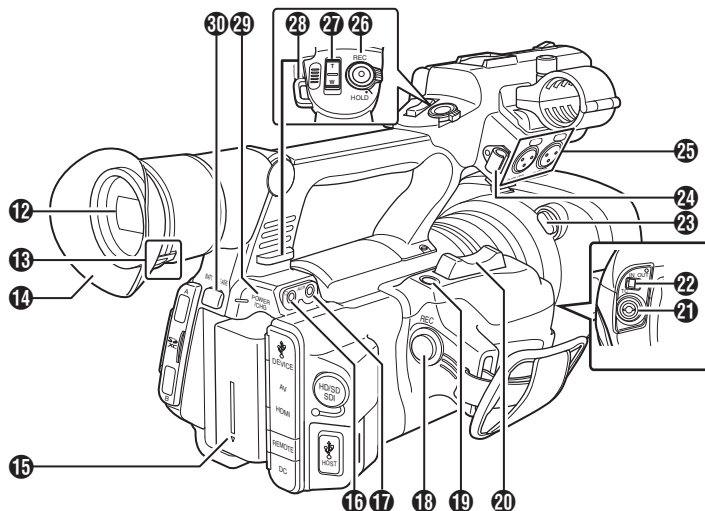

**18** [REC] Record Trigger Button

Starts/stops recording.

Memo : \_\_\_\_\_

- This button is interlocked with the [REC] button **9** at the bottom of the lens and the [REC/HOLD] button **26** at the top of the handle.

**19** [C.REVIEW/7] Clip Review/User 7 Button

For checking the most recently captured images.

(☞ P72 [Viewing Recorded Videos Immediately (Clip Review)])

You can also use it as a user button by assigning a specific feature in the menu setting to this button.

(☞ P38 [Assigning Functions to User Buttons])

**20** Zoom Lever at the Grip

To operate zoom servo with the zoom lever at the grip, set the [ZOOM SERVO/MANUAL] switch **10** to "SERVO".

(☞ P47 [Using the Zoom Lever at the Grip])

**21** [TC] TC Input/Output Terminal

(☞ P64 [Time Code and User's Bit])

**22** [IN/OUT] TC IN/OUT Selection Switch

(☞ P68 [Synchronizing Time Code on Another Camera])

**23** Hood Release Button

(☞ P28 [Attaching/Detaching the Hood])

**24** External Microphone Cable Clamp

(☞ P27 [Attaching an External Microphone])

**25** [INPUT1/INPUT2] Audio Input Terminal 1, 2

(XLR 3-pin x 2)

(☞ P27 [Attaching an External Microphone])

**26** [REC/HOLD] Record Trigger Button/Lock

Switch

Starts/stops recording.

Set the switch to [HOLD] to lock the [REC] Trigger button.

Memo : \_\_\_\_\_

- This button is interlocked with the [REC] button **18** on the grip and the [REC] button **9** at the bottom of the lens.
- The [REC] button **18** on the grip and the [REC] button **9** at the bottom of the lens will not be locked.

**27** Zoom lever at the Handle

(☞ P47 [Using the Zoom Lever at the Handle])

**28** Shoulder Belt Mount (x2)

For mounting a shoulder belt (sold separately).

Caution : \_\_\_\_\_

- Be sure to use a shoulder belt with the strength to withstand the weight of this camera recorder.
- If the shoulder belt is not properly attached, the camera recorder may fall and cause injuries.
- Check the instruction manual provided with the shoulder belt before using.

**29** [POWER/CHG] Power/Charging Display Lamp

(☞ P28 [Using a Battery Pack])

**30** [BATT. RELEASE] Battery Lock Release Button

(☞ P29 [Removing the Battery])

## Side Control Panel

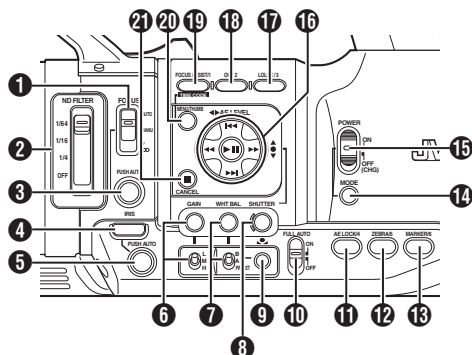

- 1 [FOCUS AUTO/MANU/∞] Focus Switch  
(☞ P48 [Focus Operation] )
- 2 [ND FILTER] ND Filter Switch  
(☞ P56 [Setting the ND Filter] )
- 3 [PUSH AUTO] Focus Push Auto Button  
(☞ P49 [One Push Auto Focus] )
- 4 [IRIS] Iris Auto/Manual Selection Button  
(☞ P52 [Adjusting the Iris] )
- 5 [PUSH AUTO] Iris Push Auto Button  
(☞ P52 [Adjusting the Iris] )
- 6 [GAIN] Gain Auto/Manual Selection Button / [L/M/H] Sensitivity Selection Switch  
(☞ P53 [Setting the Gain] )
- 7 [WHT BAL] White Balance Auto/Manual Selection Button / [B/A/PRESET] Selection Switch  
(☞ P56 [Adjusting the White Balance] )
- 8 [SHUTTER] Shutter Speed Auto/Manual Selection Button  
(☞ P54 [Setting the Electronic Shutter] )
- 9 [One Push Auto] One Push Auto White Balance Button
- 10 [FULL AUTO ON/OFF] Full Auto Switch  
(☞ P51 [Adjusting the Brightness Automatically] )  
(☞ P59 [Automatic White Balance Mode (FAW: Fulltime Auto White balance)] )
- 11 [AE LOCK/4] AE Lock/User 4 Button  
When Gain, Iris, and Shutter are set to "AUTO", their respective values and the value of white balance are locked when the [AE LOCK/4] button is pressed.  
You can also use it as a user button by assigning a specific feature in the menu setting to this button.  
(☞ P38 [Assigning Functions to User Buttons] )

- 12 [ZEBRA/5] Zebra/User 5 Button  
(☞ P69 [Setting Zebra Pattern] )  
You can also use it as a user button by assigning a specific feature in the menu setting to this button.  
(☞ P38 [Assigning Functions to User Buttons] )
  - 13 [MARKER/6] Marker/User 6 Button  
This button toggles ON/OFF the marker, safety zone, and center mark displays.  
You can also use it as a user button by assigning a specific feature in the menu setting to this button.  
(☞ P38 [Assigning Functions to User Buttons] )
  - 14 [MODE] Camera/Media Mode Selection Button  
(☞ P18 [Operation Modes] )
  - 15 [POWER ON/OFF(CHG)] Lock Power ON/OFF Switch  
Turns ON/OFF the power.
    - Hold down the lock button (blue) in the center to toggle ON/OFF.
    - When the power is turning OFF, "P.OFF" appears on the LCD monitor and viewfinder.
    - Wait for 5 seconds or more to turn on the power again.
  - 16 Cross-Shaped Button (▲▼◀▶)/Set Button (●)  
The function changes according to the operation status of the camera recorder.
    - During menu operation (all modes)  
(☞ P91 [Basic Operations in Menu Screen] )  
Center Set button (●) : Confirms menu items and setting values  
Cross-shaped button (▲▼) : Selects menu items and setting values
    - During Camera mode  
Shutter operation:  
Center Set button (●) : Shutter ON/OFF  
Cross-shaped button (▲▼) : Switches shutter speed when shutter is ON
    - AE level operation : Cross-shaped button (◀▶)
- Memo : \_\_\_\_\_
- When [Camera Function] → [AE LEVEL SW] is set to "AE LEVEL/VFR", the cross-shaped button (◀▶) is used to set the number of frames during Variable Frame Rec.  
(☞ P82 [Variable Frame Rec] )  
(☞ P96 [ AE LEVEL SW ] )
- 
- 17 [LOLUX/3] Low-light Shooting/User 3 Button  
For switching the low-light shooting mode ON or OFF.  
You can also use it as a user button by assigning a specific feature in the menu setting to this button.  
(☞ P38 [Assigning Functions to User Buttons] )

- 18** [OIS/2] Optical Image Stabilizer/User 2 Button  
For switching the image stabilizer feature mode ON or OFF.

You can also use it as a user button by assigning a specific feature in the menu setting to this button.

(☞ P38 [Assigning Functions to User Buttons] )

- 19** [FOCUS ASSIST/1] Focus Assist/User 1 Button  
For switching the focus assist function ON or OFF.

(☞ P49 [Focus Assist Function] )

You can also use it as a user button by assigning a specific feature in the menu setting to this button.

(☞ P38 [Assigning Functions to User Buttons] )

- 20** [MENU/THUMB] Menu/Thumbnail Button

- Displays the menu screen during Camera mode.

(☞ P91 [Basic Operations in Menu Screen] )

- Displays the menu screen when the button is pressed during thumbnail display in the Media mode.
- Stops playback and displays the thumbnail screen when the button is pressed during playback screen display in the Media mode.

- 21** [CANCEL] Cancel Button

Cancels various settings and stops playback.

## SD Slot

(☞ P39 [SD Card] )

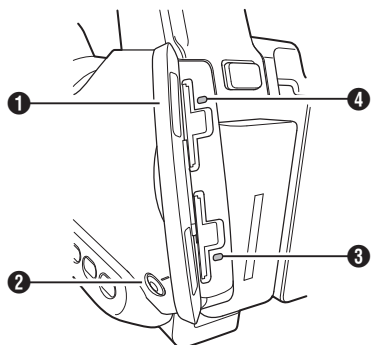

- 1** SD Card Cover
- 2** [SLOT A/B] Card Slot Selection Button  
For switching the active card slot during shooting and playback.
- 3** Card Slot B Status Indicator
- 4** Card Slot A Status Indicator

## Rear Terminal

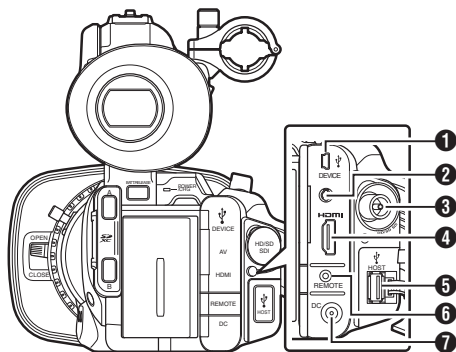

- 1** [DEVICE] USB Mini Terminal  
(☞ P134 [Managing/Editing Clips on a PC] )
- 2** [AV] AV Output Terminal  
(☞ P135 [Connecting External Monitor] )
- 3** [HD/SD SDI] SDI Output Terminal (BNC)  
(☞ P135 [Connecting External Monitor] )
- 4** [HDMI] HDMI Output Terminal  
(☞ P135 [Connecting External Monitor] )
- 5** [HOST] USB Host Terminal  
For connecting a USB adapter according to the intended purpose when you are connecting the unit to a network.  
(☞ P139 [Camera Setup for Network Connection] )
- 6** [REMOTE] Remote Terminal  
(☞ P137 [Connecting Wired Remote Control] )
- 7** [DC] DC Input Terminal  
Input terminal for DC 12 V power supply. For connecting with the supplied AC adapter.  
(☞ P30 [Using AC Power (DC IN Power)] )

## LCD Monitor

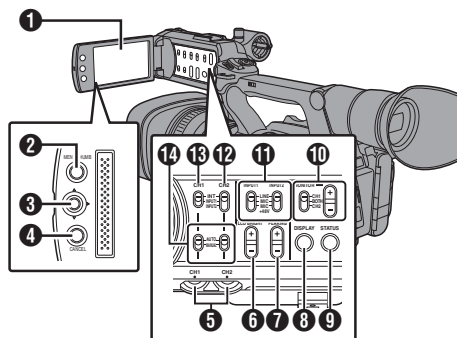

- 1** LCD Monitor  
(☞ P36 [Adjusting the LCD Monitor and Viewfinder] )
- 2** [MENU/THUMB] Menu/Thumbnail Button

  - Displays the menu screen during Camera mode.  
(☞ P91 [Basic Operations in Menu Screen] )
  - Displays the menu screen when the button is pressed during thumbnail display in the Media mode.
  - Stops playback and displays the thumbnail screen when the button is pressed during playback screen display in the Media mode.
- 3** LCD Cross-Shaped Button (▲▼◀▶)/Set Button (●)

The function changes according to the operation status of the camera recorder.

  - During menu operation (all modes)  
(☞ P91 [Basic Operations in Menu Screen] )

Center Set button (●) : Confirms menu items and setting values

Cross-shaped button : Selects menu items and setting values (▲▼)

  - During Camera mode

You can also use it as a user button by assigning a specific feature in the menu setting to this button.  
(☞ P38 [Assigning Functions to User Buttons] )
- 4** [CANCEL] Cancel Button

Cancels various settings and stops playback.
- 5** [CH1/CH2] CH1/CH2 Recording Level Adjustment Knob  
(☞ P61 [Audio Recording] )
- 6** [LCD BRIGHT +/-] LCD Display Brightness Adjustment Button  
(☞ P36 [Adjusting the Brightness] )
- 7** [PEAKING +/-] LCD/VF Contour Adjustment Button  
(☞ P37 [Adjusting the Contour (LCD)] )  
(☞ P37 [Adjusting the Contour (Viewfinder)] )
- 8** [DISPLAY] Display Button

  - Press the [DISPLAY] button to switch to the display screen during normal screen display (when the menu screen is not displayed).  
(☞ P34 [Display Screen] )
  - Switches between [Main Menu] and [Favorites Menu] when the [DISPLAY] button is pressed while the menu screen is displayed.  
(☞ P91 [Basic Operations in Menu Screen] )
- 9** [STATUS] Status Screen Display Button

Press the [STATUS] button to display the status screen on the viewfinder and LCD monitor during normal screen display (when the menu screen is not displayed).  
(☞ P35 [Status Screen] )
- 10** [MONITOR]/[+/-] Audio Monitor Selection Switch/Volume Adjustment Button

Switches the audio monitor and adjusts the monitor speaker/headphone.  
(☞ P63 [Monitoring Audio Sound During Recording Using a Headphone] )
- 11** [INPUT1/INPUT2] Audio Input Signal Selection Switch  
(☞ P61 [Audio Recording] )
- 12** [CH2] CH2 Audio Input Signal Selection Switch

Select the audio input terminal to record to CH2.  
(☞ P61 [Audio Recording] )
- 13** [CH1] CH1 Audio Input Signal Selection Switch  
(☞ P61 [Audio Recording] )
- 14** [CH1/CH2 AUTO/MANUAL] CH1/CH2 Audio Recording Mode Switch  
(☞ P62 [Adjusting Audio Recording Level] )

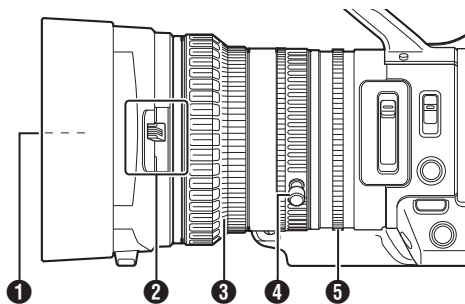

### 1 Filter Built-In Screw

- Transparent or UV filter for lens protection, or filters for various effects can be installed.
- Installable filter types:  $\Phi 72\text{mmP0.75}$

Memo : \_\_\_\_\_

- Remove the lens hood when installing the filter.  
(☞ P28 [Attaching/Detaching the Hood] )

### 2 Lens Cover Open/Close Switch

(☞ P28 [Opening/Closing the Lens Cover] )

### 3 Focus Ring

(☞ P48 [Focus Operation] )

### 4 Zoom Ring

(☞ P47 [Zoom Operation] )

To operate zoom with this ring, set the [ZOOM SERVO/MANUAL] switch to "MANUAL".

### 5 Iris Ring

(☞ P52 [Adjusting the Iris] )

To operate auto iris, press the [IRIS] button on the side control panel.

(A mark appears on the screen)

# Basic System Diagram

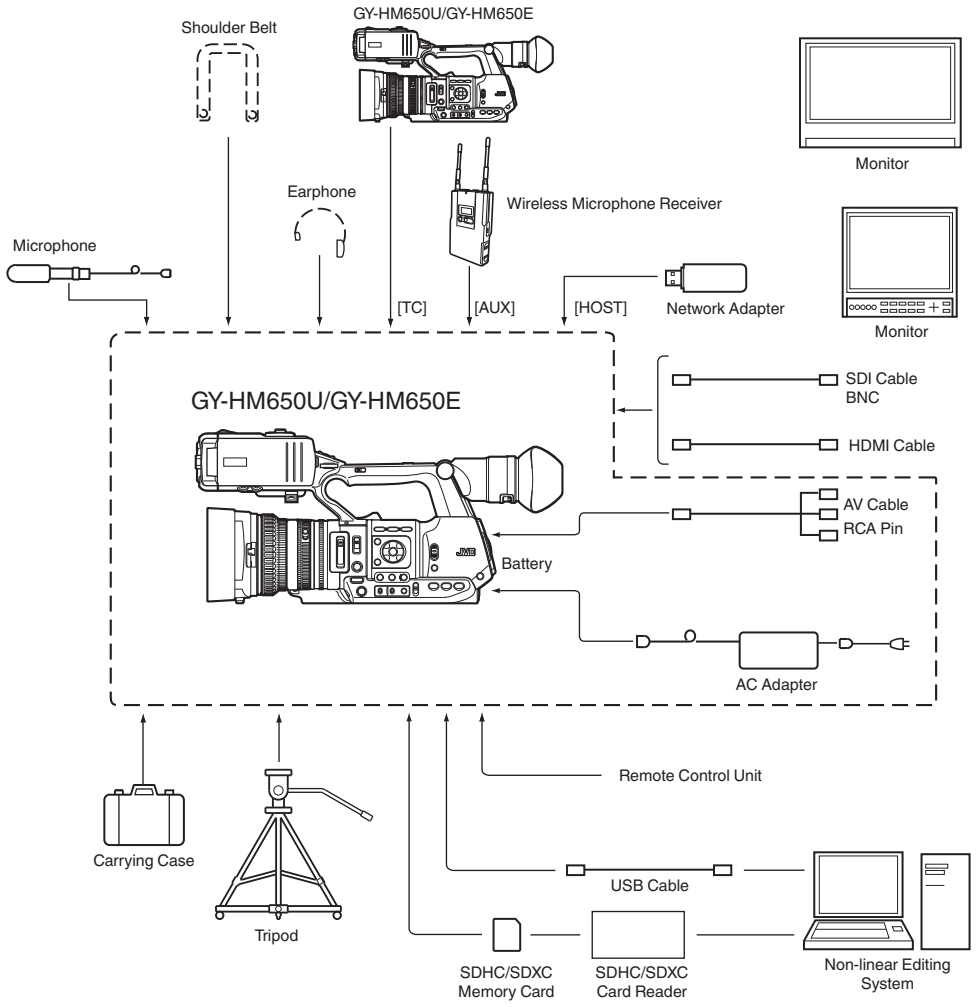

# Settings and Adjustments Before Use

## Adjusting the Grip Belt

Open the pad and adjust the position of the grip belt accordingly.

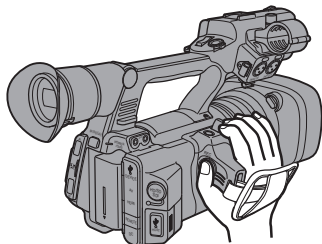

Caution :

- If the grip is loose, the camera recorder may fall off resulting in injuries or malfunction.

## Attaching an External Microphone

You can attach a separately sold microphone to the microphone holder.

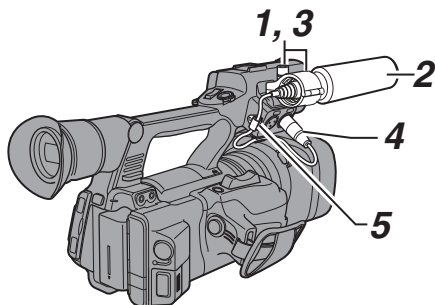

- 1 Turn the knob on the microphone holder anticlockwise to loosen and open the microphone holder.
- 2 Place the microphone in the microphone holder.
- 3 Turn the knob on the microphone holder clockwise to secure the microphone.
- 4 Connect the microphone cable to the [INPUT1] or [INPUT2] terminal.
- 5 Pin the microphone cable to the clamp.
- 6 Perform the settings for the microphone correctly.  
(P61 [Audio Recording])

## Attaching the Tripod

Use the screw hole at the bottom of this camera recorder.

(3/8×16UNC, 1/4×20UNC)

Use the screw hole that suits the tripod.

To prevent the camera recorder from falling off, which may result in injuries or damages, read the instruction manual of the tripod to be used and make sure that it is securely attached.

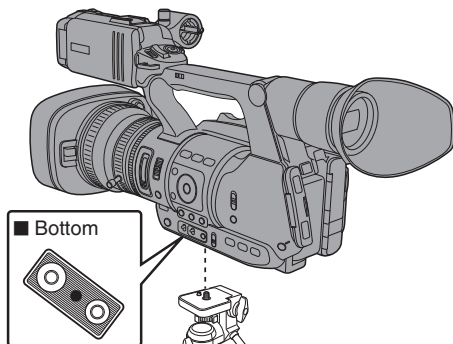

Caution :

- Use the tripod on a stable surface.
- To prevent the camera recorder from falling, attach securely using the rotation prevention hole.
- Use screws with screw length 5 mm and below.

## Attaching the Large Eyecup

- Attach the large eyecup (supplied) to prevent external light from entering the viewfinder screen and cameraman's vision.
- Align and attach to the groove of the eyecup mounted on the camera recorder.
- The large eyecup can be attached in any direction.

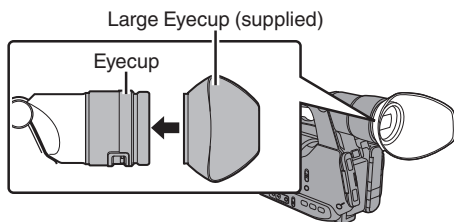

Memo :

- Do not remove the eyecup that is premounted on the camera recorder.

## Opening/Closing the Lens Cover

Use the lens cover open/close switch to open or close the lens cover.  
 Before shooting, open the lens cover.  
 When this camera recorder is not in use, close the lens cover to protect the lens.

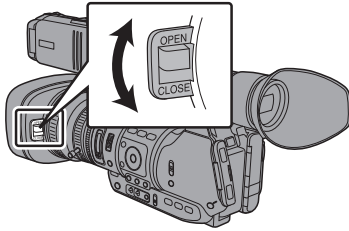

Caution :

- Do not press against the lens cover with force. Doing so may damage the lens or the cover.

## Attaching/Detaching the Hood

### Attaching the Hood

Align the markings on the camera recorder and hood; turn the hood in the direction of the arrow until it is locked.

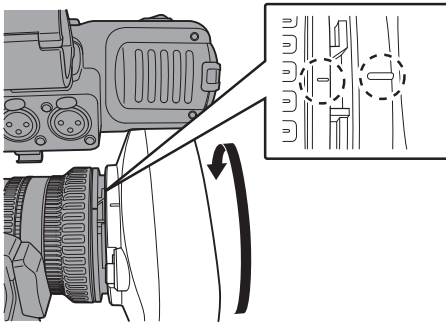

## Detaching the Hood

- Remove the hood when attaching a filter, teleconverter or wide converter to the front of the lens.
- While pressing the hood release button, turn the hood in the anti-clockwise direction to remove it.

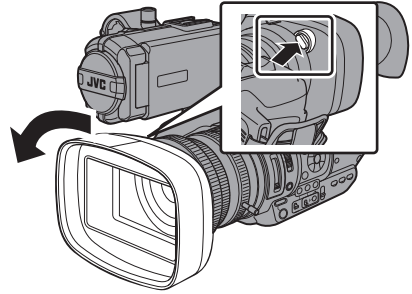

## Power Supply

To use this camera recorder, you can attach a battery pack or connect an AC adapter to it.

- P28 [Using a Battery Pack]
- P30 [Using AC Power (DC IN Power)]

Caution :

- Set the [POWER ON/OFF(CHG)] switch to "OFF(CHG)" before changing the power supply that operates this camera recorder.

## Using a Battery Pack

### Charging the Battery

Charge the battery immediately after purchase or when the battery power is running low.

\* The battery is not charged when purchased.

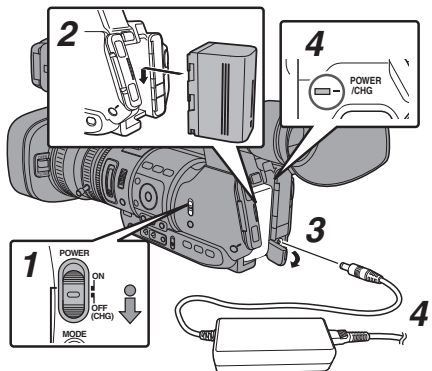

- 1 Hold down the lock button (blue) at the center of the [POWER ON/OFF(CHG)] switch to set to “OFF(CHG)”.**
- 2 Attach the supplied battery.**  
Slide it in until you hear a click.
- 3 Connect the supplied AC adapter to the [DC] terminal.**  
Open the cover of the [DC] terminal and connect as shown in the diagram.
- 4 Connect the AC adapter to a power outlet.**
  - The [POWER/CHG] lamp blinks during charging and will go out after charging is complete.
  - Remove the AC adapter after charging is complete.

Memo : \_\_\_\_\_

- Blinking of the [POWER/CHG] lamp during charging indicates the charge level.

[POWER/CHG] Lamp	Charge Level
Orange blinking (4 times per second)	Less than 25%
Orange blinking (3 times per second)	Less than 50%
Orange blinking (2 times per second)	Less than 75%
Orange blinking (1 time per second)	Less than 100%
Light goes out	Fully charged

## Removing the Battery

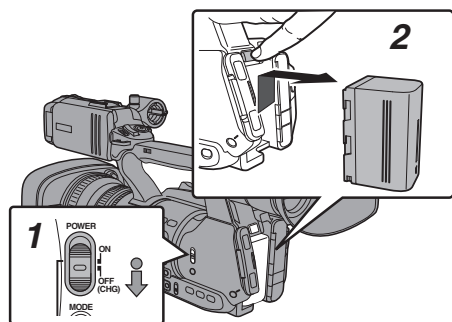

- 1 Hold down the lock button (blue) at the center of the [POWER ON/OFF(CHG)] switch to set to “OFF(CHG)”.**
- 2 While pressing and holding the [BATT. RELEASE] button, push up and remove the battery in the direction of the arrow.**

Caution : \_\_\_\_\_

- Do not remove the battery when the [POWER ON/OFF(CHG)] switch is “ON”.
- Do not insert or remove the DC cable when the battery is in use.
- Leaving the camera recorder unused with the battery inside will deplete the battery power even if you set the [POWER ON/OFF(CHG)] switch to “OFF(CHG)”. Remove the battery if you are not using the camera recorder.

## Estimated Charging and Continuous Operating Times

■ Charging Time (supplied SSL-JVC50 battery pack)

Approx. 4 h

Memo : \_\_\_\_\_

- Use up the charge completely before you charge the battery. If the battery is not fully discharged before charging, the battery capacity may drop after repeated cycles.
- If the battery capacity drops due to repetitive shallow charging and discharging, it may be recovered by using up the charge completely and then fully charging the battery again.
- If you charge the battery immediately after using while the battery is still warm, it may not be fully charged.
- It is recommended that you charge the battery in an environment between 10 °C and 35 °C (50 °F and 95 °F). The battery may not be fully charged or the charging time may be prolonged if charged under low temperatures (below 10 °C/ 50 °F).

■ Continuous Operating Time (supplied SSL-JVC50 battery pack)

Approx. 1 hrs 50 mins

Memo : \_\_\_\_\_

- Actual operating times may differ depending on the age of the battery, charging condition, and operating environment.
- Operating time is shortened in cold environment.
- The operating time may shorten when power zoom is used, accessories are connected, or when the LCD monitor is frequently used.
- For purchase of spare batteries and battery charger, consult your nearest JVC dealer.

## Precautions for Batteries

- Store the battery in a cool and dry place when not in use. Do not expose the battery to high temperatures (such as in a car under direct sunlight). This will cause battery leakage and shorten the battery life.
- If the operating time shortens drastically even after charging, the battery may be reaching the end of its life. Replace the battery with a new one.

## Using AC Power (DC IN Power)

Use the supplied AC adapter to operate the camera recorder with AC power.

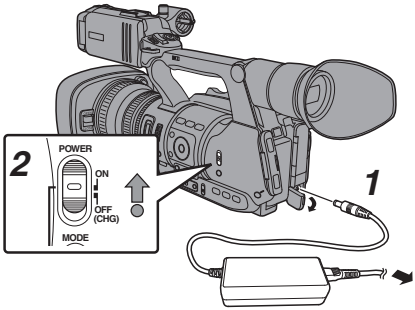

- 1 **Connect the DC cable of the AC adapter to the [DC] terminal of the camera recorder.**
  - Check that the power switch of the camera recorder is set to “OFF(CHG)”.
  - Open the cover of the [DC] terminal and connect as shown in the diagram.
- 2 **Hold down the lock button (blue) at the center of the [POWER ON/OFF(CHG)] switch to set to “ON”.**  
Power will be supplied to the camera recorder.

**Caution :**

- Do not insert or remove the DC cable during recording.
- Do not use power supply of high voltage fluctuation, containing noise such as ripple, or with insufficient capacity.

### Charging the Built-In Battery

- The date/time and time code data are stored using the built-in rechargeable battery.
- When power is connected to the camera recorder, the built-in battery always gets charged. When the power is disconnected, the battery gradually discharges.
- The battery will be totally discharged if left unused for 3 months and the date/time and time code data will be reset. When this happens, set the [POWER ON/OFF(CHG)] switch to “ON” to display the [Initial Setting] screen, then set the date/time.  
(☞ P32 [Initial Settings] )

## Power Status Display

### Viewfinder Screen and LCD Monitor

The power status is displayed on the display and menu screens.

Display	Description
	Currently powered by a battery. When the battery power runs out, the battery mark appears hollow, and “RES” (yellow) is displayed.  Memo : _____ • You can set the display using [LCD/VF] → [Display Settings] → [Battery]. (☞ P106 [ Battery ] )
	Currently powered by an AC adapter.

**Memo :**

- If the supplied battery (or equivalent battery sold separately) is not used, the battery mark which indicates the battery level may not appear.

### Display Screen

- (☞ P121 [Display Screen in Camera Mode] )
- (☞ P126 [Display Screen in Media Mode] )

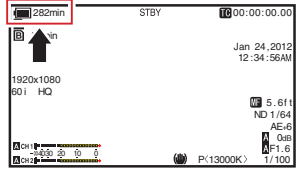

### Menu Screen

- (☞ P92 [Display and Description of the Menu Screen] )

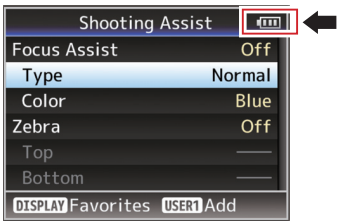

## Warnings by Lamp and Warning Tone

Warning status is indicated by tally lamp and warning tone.

- The tally lamp blinks.
- The warning tone is output from the monitor speaker or [Q] terminal.

Memo : \_\_\_\_\_

- If you continue to use the camera recorder while the power warning is displayed, the camera recorder will stop automatically when the battery or supplied voltage from the AC adapter becomes lower.

Caution : \_\_\_\_\_

- The remaining battery power and time are displayed as they are from the battery information. Accurate data may not be displayed depending on the battery condition. Replace the battery as soon as possible when the remaining battery power and time are low.

## Turning On/Off the Power

### Turning On the Power

- 1 **Hold down the lock button (blue) at the center of the [POWER ON/OFF(CHG)] switch to set to "ON".**

The camera recorder starts up in Camera mode and is ready for shooting.

Memo : \_\_\_\_\_

- The camera recorder always start up in Camera mode when the [POWER ON/OFF(CHG)] switch is set to "ON". Use the [MODE] button at the side of the camera recorder to switch mode. (☞ P18 [Operation Modes] )

### Turning Off the Power

Sets the camera recorder to the recording standby or stop mode.

- 1 **Hold down the lock button (blue) at the center of the [POWER ON/OFF(CHG)] switch to set to "OFF(CHG)".**
- 2 **Remove the battery and the power to the [DC] terminal (when not in use for a long time).**

### Auto Power Off function

When [System] → [Auto Power Off] is set to "On", the power turns off automatically when the camera recorder is not operated for 5 minutes or longer while running on battery.

(☞ P110 [ Auto Power Off ] )

Memo : \_\_\_\_\_

- When both the battery and AC adapter are connected, power from the AC adapter connection will be used. As such, the [Auto Power Off] function will not have any effect.

Caution : \_\_\_\_\_

- Do not set the [POWER ON/OFF(CHG)] switch to "OFF(CHG)" during recording. Check that the operation mode display is "STBY" or "STOP" before you turn off the power.
- If you have mistakenly set the [POWER ON/OFF(CHG)] switch to "OFF(CHG)" during recording, wait for 5 seconds or more before you turn on the power again.
- When turning off the power, first set the [POWER ON/OFF(CHG)] switch of the camera recorder to "OFF(CHG)". Do not remove the battery or turn off the AC power while the [POWER ON/OFF(CHG)] switch is set to "ON".

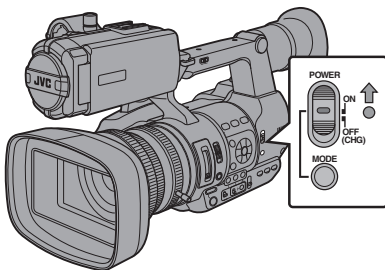

# Initial Settings

When the power is first turned on, the Initial Setting screen for performing the initial settings in the camera recorder appears.

Set the date/time of the built-in clock in the [Initial Setting] screen.

All operations are disabled until initial settings are complete.

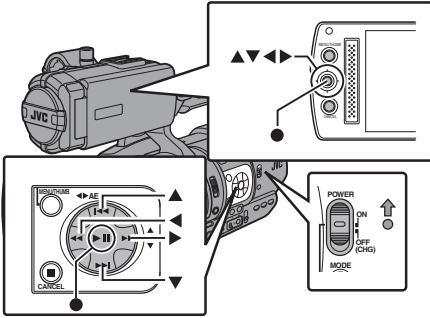

Memo : \_\_\_\_\_

- It is recommended to use the AC adapter as the power supply.
- Be sure to close the lens cover.

**1 Hold down the lock button (blue) at the center of the [POWER ON/OFF(CHG)] switch to set to "ON".**

The Initial Setting screen appears.

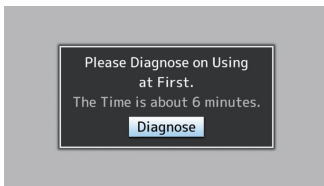

**2 Ensure that the lens cover is closed, and press the Set button (●).**

- Self-diagnosis starts.
- A progress bar appears, and "Complete Diagnosis" appears when the diagnosis is complete.

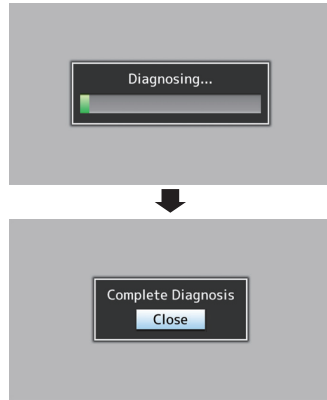

Memo : \_\_\_\_\_

- It takes about 6 minutes to complete the diagnosis. During the diagnosis, do not operate or turn off the camera recorder.

**3 Press the Set button (●) after confirming the exit screen.**

The [Initial Setting] screen appears.

- For GY-HM650U

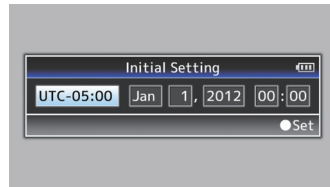

- For GY-HM650E

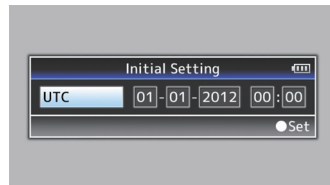

Memo : \_\_\_\_\_

- The [Initial Setting] screen appears when the power is turned on for the first time and when the power is turned on after the built-in battery is fully discharged.
- The configured date/time data is saved in the built-in rechargeable battery even if the power is turned off.

#### 4 Set the time zone and date/time.

- ① Move the cursor with the cross-shaped button (◀▶) and select the setting item.
- ② Change the values with the cross-shaped button (▲▼).

#### 5 Press the Set button (●) after setting is complete.

The clock is set to 0 seconds of the input date/time.

Memo : \_\_\_\_\_

- The configured date/time data can be displayed on the LCD monitor and viewfinder and be recorded to the SD card.
- The value of the year can be set in the range of “2000” to “2099”.

## Changing the Time after Initial Setting

### Setting the Date/Time

( P111 [ Date/Time ] )

#### 1 Select [System] → [Date/Time].

The [Date/Time] screen appears.

#### 2 Set the date and time.

- ① Move the cursor with the cross-shaped button (◀▶) and select the setting item.
- ② Change the values with the cross-shaped button (▲▼).

#### 3 Press the Set button (●) after setting is complete.

The clock is set to 0 seconds of the input date/time.

## Changing the Display Style

You can change the display style of the date/time on the menu.

### Setting the Date Display (Date Style)

( P106 [ Date Style ] )

The date display can be changed in [LCD/VF] → [Display Settings] → [Date Style].

### Setting the Time Display (Time Style)

( P106 [ Time Style ] )

The time display can be changed in [LCD/VF] → [Display Settings] → [Time Style].

## Date/Time Display in Each Operation Mode

During Camera mode:

Date/time of the built-in clock is displayed.

During Media mode:

Shooting date/time of the clip being played back is displayed.

# Displays on the LCD Monitor and Viewfinder

You can display the camera status, media information, zebra pattern, and various markers in the video image on the LCD monitor and viewfinder screen during shooting.

Memo : \_\_\_\_\_

- When [Main Menu] → [A/V Set] → [Video Set] → [Display On TV] is set to "On", the display screen and menu screen are also displayed in the video image from the video signal output terminal.  
(P107 [ Display On TV ])

## Display Screen

### Display Screen in Camera Mode

- The display switches between three screen types with every press of the [DISPLAY] button. (Display 0 → 1 → 2 → 0)
- Press the [STATUS] button to switch to the status screen.

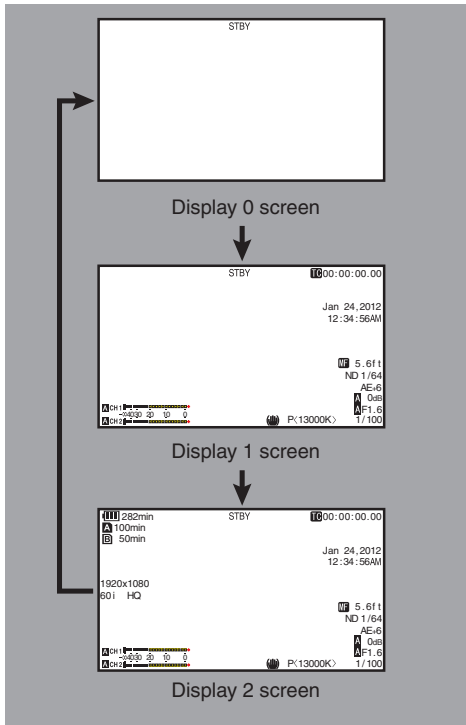

### Display Screen (VF/LCD) in Media Mode

(P126 [Display Screen in Media Mode] )

- This is the screen display during clip playback in Media Mode.
- The display switches between three screen types with every press of the [DISPLAY] button. (Display 0 → 1 → 2 → 0)

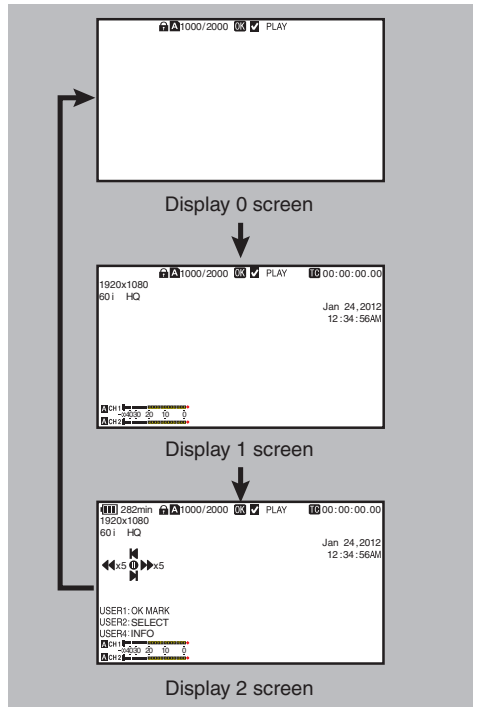

## Status Screen

- This screen allows you to check the current settings.
- To display the status screen, press the [STATUS] button in the normal screen.
- The status display differs according to the operation mode (two types). (☞ P18 [Operation Modes] )
- Press the [STATUS] button to switch to the display screen.
- Press the [MENU] button at each status screen (other than the [Camera 1]/[Camera 2] screen) to enter the setting screen.
- Use the cross-shaped button (◀▶) to switch screens as follows:

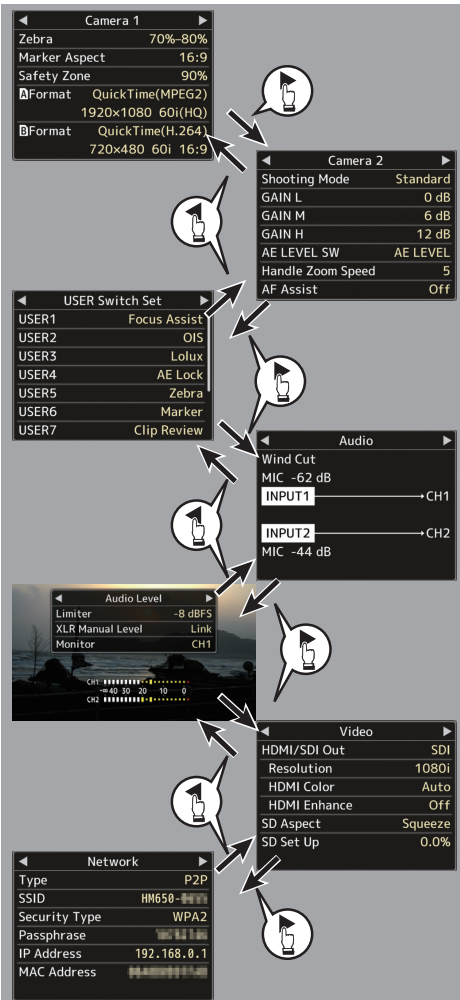

## USB Mode Screen

This screen displays the USB mode.



## Remote Edit Mode Screen

This is a mode for accessing the page for editing the metadata that is recorded in a clip via a browser on devices such as a smartphone, tablet terminal, or PC.

(☞ P148 [Clip Metadata] )

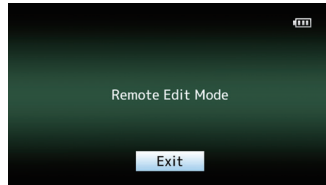

## Warning Display

- Warning display is displayed in the display screen (Camera mode, Media mode).
- If error occurs during status screen display, the display will return to the display screen to display the warning. (☞ P159 [Error Messages and Actions] )

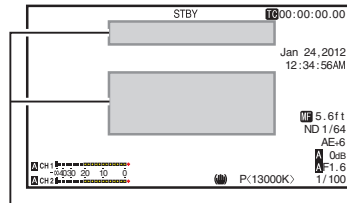

Warning Display Area

# Adjusting the LCD Monitor and Viewfinder

You can monitor video images on this camera recorder using the viewfinder, LCD monitor, or both.

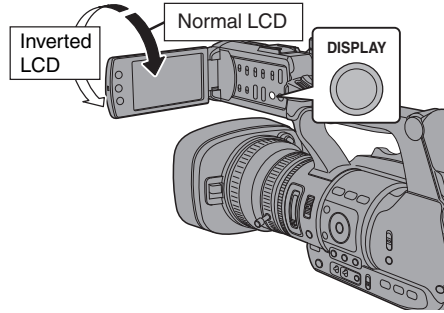

# Adjusting the LCD Monitor

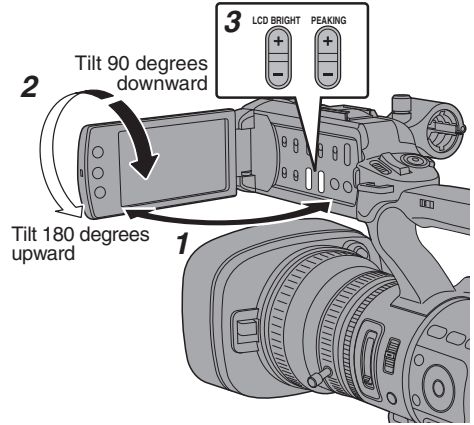

## Displays on the LCD Monitor and Viewfinder Screen (VF)

When [LCD/VF] → [LCD + VF] is set to “Off”

(☞ P103 [ LCD + VF ])

LCD Monitor Status	LCD Display	VF Display
LCD closed	Normal LCD	OFF
	Inverted LCD	ON
LCD opened	Normal LCD	ON
	Inverted LCD	ON

\* Turns on when [LCD/VF] → [LCD + VF] is set to “On”.

Memo : \_\_\_\_\_

- Press and hold the [DISPLAY] button for 2 seconds to turn ON/OFF the LCD monitor.
- The function to switch between LCD monitor and viewfinder displays by pressing the [DISPLAY] button can be canceled by opening/closing or rotating the LCD monitor.
- The viewfinder screen is always displayed when [LCD/VF] → [LCD + VF] is set to “On”.
- You can display both the LCD monitor and viewfinder screens at the same time by setting [LCD/VF] → [LCD + VF] to “On”.

(☞ P103 [ LCD + VF ])

- 1 Open the LCD cover.
- 2 Incline the LCD cover to a position that enables easy viewing.

Rotate the LCD monitor to adjust the angle.

- While the LCD monitor is open, you can rotate it 180 degrees upward or 90 degrees downward.
- Rotating the LCD monitor 180 degrees upward enables you to see the screen from the lens side. To display the image when it is viewed from the opposite direction (mirror image), perform setting as follows.  
Set [Main Menu] → [LCD/VF] → [LCD Mirror] to “Mirror” → Set button (●)

(☞ P104 [ LCD Mirror ])

- 3 Adjust the brightness, contour, and contrast of the LCD monitor.

You can change the angle and brightness of the LCD monitor according to your usage condition. Changing the brightness of the screen will not affect the recorded images.

### Adjusting the Brightness

Use the [LCD BRIGHT +/-] button to adjust the brightness of the LCD monitor.

- The [+] button brightens the monitor and the [-] button darkens it.
- Press the [+] and [-] buttons simultaneously to return to standard settings.
- During adjustment, the brightness level is displayed on the LCD monitor.



## Adjusting the Contour

Use the [PEAKING +/-] button to adjust the contour of the LCD monitor.  
(The contour of the viewfinder screen will also be adjusted at the same time.)

- The [+] button increases contour correction and the [-] button decreases contour correction.
- Press the [+] and [-] buttons simultaneously to return to standard settings.
- During adjustment, the contour level is displayed on the LCD monitor.



Memo :

- The [PEAKING +/-] operation is disabled in the Media mode, and its value is fixed at “-10”.

## Adjusting the Contrast

Use the [LCD Contrast] menu to adjust the contrast of the LCD monitor.

- Adjust using [Main Menu] → [LCD/VF] → [LCD Contrast].
- Increasing the value increases the contrast. [Setting Values: +10 to -10] (Default value: 0)

## Adjusting the Viewfinder

You can change the brightness and peaking of the viewfinder screen according to your usage conditions.

Changing the brightness of the screen will not affect the recorded images.

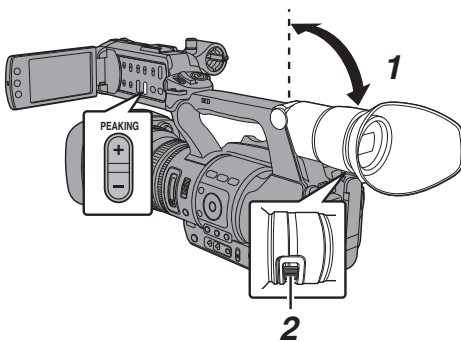

Caution :

- A high-definition viewfinder is used on this camera recorder in order to provide an accurate focusing environment. Due to the characteristic of the display device, colors may appear on the images when you blink your eyes. This is not a malfunction. It does not affect the recorded images, SDI output, AV output, or HDMI output.

- Incline the viewfinder vertically to a position that enables easy viewing.**
- Turn the visibility adjustment lever to adjust the visibility.**  
Turn the visibility adjustment lever to sharpen the image on the viewfinder screen.
- Adjust the brightness, contour, and contrast of the viewfinder screen.**

## Adjusting the Brightness

Use the [VF Bright] menu to adjust the brightness of the viewfinder screen.

- Adjust using [Main Menu] → [LCD/VF] → [VF Bright].
- Increasing the value increases the brightness. [Setting Values: +10 to -10] (Default value: 0)

## Adjusting the Contour

Use the [PEAKING +/-] button to adjust the contour of the viewfinder screen.

The contour of the LCD monitor will also be adjusted at the same time.

(☞ P37 [Adjusting the Contour] )

Memo :

- When [Main Menu] → [LCD/VF] → [LCD + VF] is set to “Off”, operate after switching to the viewfinder display by pressing the [DISPLAY] button for 2 seconds or longer.
- The [PEAKING +/-] operation is disabled in the Media mode, and its value is fixed at “-10”.

## Adjusting the Contrast

Use the [VF Contrast] menu to adjust the contrast of the viewfinder screen.

- Adjust using [Main Menu] → [LCD/VF] → [VF Contrast].
- Increasing the value increases the contrast. [Setting Values: +10 to -10] (Default value: 0)

## Displaying in Black and White

You can display the viewfinder screen in black and white.

- [Main Menu] → [LCD/VF] → [VF Color] item  
→ Press Set button (●) → Select "Off" →  
Press Set button (●).  
(☞ P103 [VF Color])

## Assigning Functions to User Buttons

You can assign functions to the following buttons and use them as user buttons. By assigning functions to the buttons, the usability of the camera recorder is enhanced. Perform settings in the menu items corresponding to each button.

Button	Menu Item
[FOCUS ASSIST/1] Button	[USER1]
[OIS/2] Button	[USER2]
[LOLUX/3] Button	[USER3]
[AE LOCK/4] Button	[USER4]
[ZEBRA/5] Button	[USER5]
[MARKER/6] Button	[USER6]
[C.REVIEW/7] Button	[USER7]
LCD Cross-Shaped Button (▲)	[LCD KEY▲]
LCD Cross-Shaped Button (▼)	[LCD KEY▼]
LCD Cross-Shaped Button (◀)	[LCD KEY◀]
LCD Cross-Shaped Button (▶)	[LCD KEY▶]

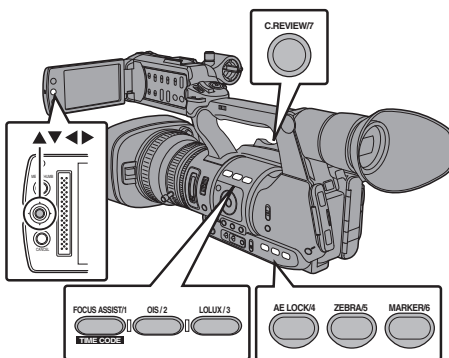

## 1 Assign functions to the buttons from the menu.

Set items in [Main Menu] → [Camera Function] → [User Switch Set] → [USER1]-[USER7], [LCD KEY▲], [LCD KEY▶], [LCD KEY▼], [LCD KEY◀].  
(☞ P97 [User Switch Set Item])

Memo :

- Operations of the user buttons are interlocked with the menu settings.
- When the menu screen is displayed, these buttons function as the menu operation buttons. (☞ P91 [Basic Operations in Menu Screen])

## Tally Lamp

This is the indicator lamp for recording and warning.

The operation changes according to the menu settings.

The lamp blinks when the battery or remaining space on the SD card is low. (Camera mode only)

\* Set using [Main Menu] → [System] → [Tally Lamp].

(☞ P110 [Tally Lamp])

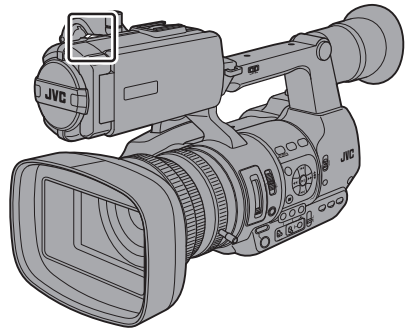

Menu setting	[Tally Lamp]	Off	On
Functional information	Warning	-	▲
	Caution	-	■
Recording status	Recording	-	●
	Special recording *	-	●

- : Lights up
- ▲ : Blinks four times in 1 second
- : Blinks once in 1 second

\* Paused state during special recording ([Clip Continuous]).

(☞ P78 [Clip Continuous Rec])

Memo :

- Blinking takes priority over lighting up.

# SD Card

This camera recorder saves the recorded images and audio sound on the SD card (sold separately) in the card slot.

## Usable Cards

Use a Class 6/10 SD card.

Memo : \_\_\_\_\_

- Depending on the recording format, SD card with Class 4 or higher performance can also be used.  
(☞ P45 [Selecting System Definition, File Format and Video Format])

Caution : \_\_\_\_\_

- Using cards other than those from Panasonic, TOSHIBA or SanDisk may result in recording failure or data loss.

## Estimated Recordable Time of SD Cards

The estimated recordable time is only a guide. Differences may occur depending on the SD card in use and the battery condition.

- (☞ P112 [A Resolution])
- (☞ P113 [B Resolution])
- (☞ P112 [A Frame & Bit Rate])
- (☞ P113 [B Frame & Bit Rate])

	QuickTime/MP4/MXF			AVCHD	
	MPEG2/HD			SP	HQ
	SP	HQ	SP		
	720p	1080i	720p/ 1080i/ 1080p	1080i	1080i
4GB	22	17	12	25	19
8GB	45	35	25	50	39
16 GB	90	70	50	100	78
32 GB	180	140	100	200	156
64 GB (SDXC)	360	280	200	400	312
128 GB (SDXC)	720	560	400	800	624

(Unit: minute)

	QuickTime		
	H.264/HD	H.264/SD	H.264/Web
	UHQ	-	LP
	1080i/1080p	480i/576i	480p
4GB	17	47	285
8GB	35	95	580
16 GB	70	190	1160
32 GB	140	380	2320
64 GB (SDXC)	280	760	4720
128 GB (SDXC)	560	1520	9440

(Unit: minute)

Memo : \_\_\_\_\_

- If the SD card contains files recorded by devices other than this camera recorder or files that are saved from a PC, the recordable time may be shorter or data may not be properly recorded.
- For each file format, up to 600 clips can be recorded to one SD card on this camera recorder. When 600 clips are recorded to one card, the remaining space is displayed as 0 min regardless of the estimated recordable time, and no further recording can be performed.
- When the file format is set to "AVCHD", up to 4000 clips can be recorded to one SD card.

## Write-Protect Switch on the SD Card

- Slide the write-protect switch upward to enable writing or deleting.
- Slide the write-protect switch downward to prevent writing or deleting. (Images in the card are protected.)

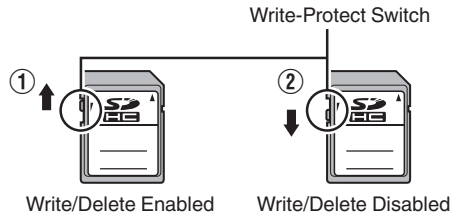

## Inserting an SD Card

This camera recorder comes with two card slots (Slot A and B) for video/audio recording and playback.

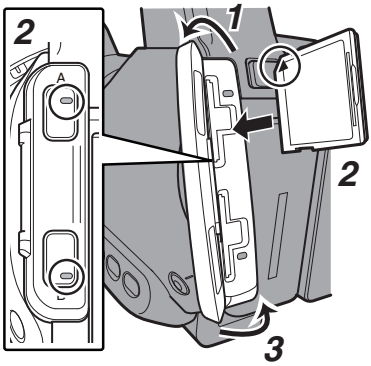

- 1 **Open the SD card cover.**
- 2 **Insert an SD card with the notched corner pointing up.**  
The status indicator of the card slot to which the card was inserted lights up in red.
- 3 **Close the SD card cover.**

### Card Slot Status Indicator

The following table shows the respective states of slot A and B.

Lamp	Slot Status
Lights up in red	The inserted SD card is being accessed. (writing/reading data) Do not turn off the power of the camera recorder or remove the SD card.
Lights up in green	On standby. The inserted SD card can be used for recording or playback.
Light goes out	<ul style="list-style-type: none"> <li>• SD card is not inserted.</li> <li>• An unusable card is inserted.</li> <li>• An SD card is inserted but a different slot is selected.</li> </ul>

## Removing the SD Card

- 1 **Check that the SD card to be removed is not being accessed (status indicator of the card slot lights up in red).**
- 2 **Open the SD card cover.**
- 3 **Push the SD card and remove it from the slot.**
- 4 **Close the SD card cover.**

Memo : \_\_\_\_\_

- When both slots are inserted with usable SD cards, the previously selected slot is used.

Caution : \_\_\_\_\_

- Data may be lost if you turn off the power of the camera recorder or remove the SD card when it is being accessed. All data recorded on the card, including the file that is being accessed, may be corrupted. Be sure to check whether the status indicator is lighted in green or not before you turn off the power or remove the SD card.
- If you mistakenly remove the card when it is being accessed, reinsert the card only after the status indicator goes off.
- The SD card may not be recognized if you insert and remove the card within a short time. When this happens, remove the card and wait for a few seconds before you reinsert.

## Switching the SD cards

When both card slots are inserted with SD cards, you can use the [SLOT A/B] button to switch the card to use.

When the memory on an SD card is full during recording, data recording automatically switches to the other card.

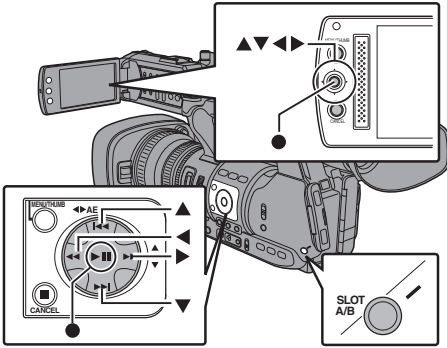

Memo : \_\_\_\_\_

- The [SLOT A/B] button is disabled during recording or playback. Cards will not be switched even if you press the button.

## Formatting (Initializing) SD Cards

When the following cards are inserted, [!FORMAT] appears at the remaining media display area. Format the card using the camera recorder menu.

Format the card using the camera recorder menu.

- Unformatted SD cards
- SD cards formatted under different specifications

\* For details of the menu operation, refer to “[Basic Operations in Menu Screen] P 91”.

Caution : \_\_\_\_\_

- Be sure to format the SD card on this camera recorder. SD cards formatted on a PC and other peripheral equipment cannot be used on this camera recorder.
- [!RESTORE] appears at the remaining media display area when an SD card that requires restoring is inserted.

- 1 Select [System] → [Media] → [Format Media].

(P110 [Format Media])

- 2 Select the slot of the SD card to be formatted and press the Set button (●).

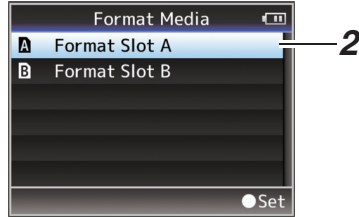

- 3 The status of the selected SD card appears.

- 4 Select [Format] and press the Set button (●).

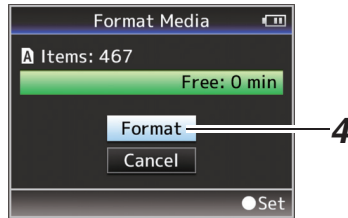

- 5 Formatting starts.

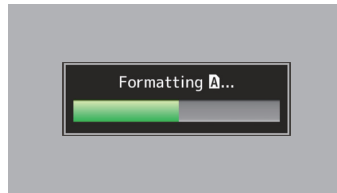

### 6 Formatting is complete.

When formatting is complete, "Complete" appears and the camera recorder returns to the [Format Media] screen.

Memo : \_\_\_\_\_

- During formatting, menu operation is unavailable but you can start recording. However, this is only available when a recordable SD card is inserted in the other slot.
- Formatting cannot be performed in the following cases.
  - Recording is in progress on the SD card to be formatted.
  - SD card is not inserted.
  - Write-protect switch of the SD card is set (🔒 is displayed).

Caution : \_\_\_\_\_

- If you format the SD card, all data recorded on the card, including video data and setup files, will be deleted.

### Restoring the SD Card

It is necessary to restore the SD card if an abnormality occurs to the data in the card due to some reasons.

Memo : \_\_\_\_\_

- [!RESTORE] appears at the remaining media display area when an SD card that requires restoring is inserted.

#### 1 Select [System] → [Media] → [Restore Media].

(P110 [ Restore Media ] )

#### 2 Select the SD card to be restored and press the Set button (●).



### 3 Restoring starts.



### 4 Restoring is complete.

- When restoring is complete, "Complete" appears and the camera recorder returns to the [Restore Media] screen.
- When no media that requires restoring is inserted, the camera recorder returns to the [Media] menu screen.

Caution : \_\_\_\_\_

- [Restore Media] can only be selected in Camera mode. However, it cannot be selected while the camera recorder is recording. Select [Restore Media] in Camera mode when the camera recorder is not recording.
- [Restore Media] does not restore the SD card to its original states completely. If restoring fails, replace or format the SD card. Take note that formatting erases all the information inside the SD card.
- Restoring cannot be performed in the following cases.
  - Camera recorder is recording in progress.
  - SD card is not inserted.
  - Write-protect switch of the SD card is set (🔒 is displayed).
  - Restoring is not required.

## Clips Recorded to SD Cards

### Folders in the SD Card

Images captured are recorded to the [PRIVATE] folder inside the SD card. Depending on the setting for [System] and [A]Format/[B]Format, the clips may be recorded in a folder created under the [PRIVATE] folder.

System	A]Format/B]Format	Record Folder
HD	QuickTime(MPEG2)	JVC/CQAV
HD	MP4(MPEG2)	JVC/BPAV
HD	AVCHD	AVCHD
HD	MXF(MPEG2)	JVC/CMAV
HD	QuickTime(H.264)	JVC/CQAVC
SD	QuickTime(H.264)	JVC/CQAVC

Memo :

- When [System] is set to “HD+Web”, web files (MOV format) will be recorded in the [DCIM] folder.
- By formatting (initializing) the SD card from the [Format Media] menu on the camera recorder, folders required for recording in the current [System] settings will be generated.
- When the [System] settings and [QuickTime(MPEG2)] settings are changed, folders required for recording in those settings will be automatically generated.

Caution :

- When a clip inside the folder is moved or deleted using the Explorer (Windows) or Finder (Mac), recording to the SD card may fail if formatting (initializing) of the card is not performed.

### Clip (Recorded Data) and Clip Name

- When recording is stopped, the images, audio and accompanying data which are recorded from start to stop are recorded as one “clip” on the SD card.
- An 8-character clip name is automatically generated for the recorded clip. (“Clip Name Prefix” + “Clip Number”)
- When [Main Menu] → [System] → [Record Set] → [Record Format] → [A]Format is set to “AVCHD”, the clip name generated consists of only the Clip Number (5-digit number). (P112 [A]Format )

Example: In the case of QuickTime/MP4

ABCG0001

Clip Number

A number in automatic ascending order is assigned in the recording order.

The Clip Number can be reset in the menu.\*

Clip Name Prefix (any four alphanumeric characters)

This is set to “xxxG” (“xxx” denotes the last 3 digits of the serial number) by default.

\* [Clip Set] → [Reset Clip Number]  
(P115 [ Reset Clip Number ] )

Memo :

- Before recording starts, you can set any characters for the clip name prefix by using [Main Menu] → [System] → [Record Set] → [Clip Set] → [Clip Name Prefix]. (P115 [ Clip Name Prefix ] )
- Changes cannot be made after recording.

### Recorded Clips

- The recorded materials may be split into several files but they can be played back continuously on the camera recorder.
- Clips may be recorded across the two SD cards in card slots A and B depending on the recording time of the clip.
- When copying videos in MP4 file format to a HDD using a PC, it is recommended to use [JVC ProHD Clip Manager Software], which is found in the supplied disc, to maintain continuity.

Caution :

- A clip recorded across several cards cannot be played back continuously. Continuous playback is only possible when the recording is made on one card.

# Basic Shooting Procedures

## Preparations

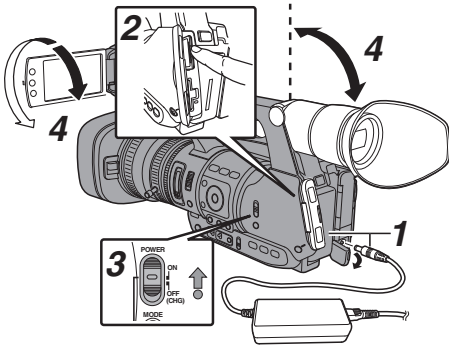

- 1 Supply battery or AC adapter power to the camera recorder.**  
(☞ P28 [Power Supply] )
- 2 Insert an SD card.**  
(☞ P39 [SD Card] )
- 3 Turn on the power of the camera recorder.**  
Hold down the lock button (blue) at the center of the [POWER ON/OFF(CHG)] switch to set to "ON". The camera recorder starts up in Camera mode and is ready for recording.
- 4 Adjust the angle of the LCD monitor and viewfinder.**  
(☞ P36 [Adjusting the LCD Monitor and Viewfinder] )

## Shooting

- 1 Configure the video and audio input settings.**  
You have to configure video settings such as brightness adjustment (iris, gain, shutter) and white balance adjustment in order to start shooting. You also have to adjust the audio input settings and audio recording level for audio recording.
  - Adjusting the Brightness  
(☞ P51 [Adjusting the Brightness] )
  - Adjusting the White Balance  
(☞ P56 [Adjusting the White Balance] )
  - Adjusting Audio Input Settings and Recording Level  
(☞ P61 [Audio Recording] )

- 2 Press the [REC] button to start recording to the SD card.**

This camera recorder has three [REC] buttons. Any of the [REC] buttons can be used to start/stop recording by default.

The tally lamp lights up in red during recording.

- Zoom Operation  
(☞ P47 [Zoom Operation] )
- Adjusting the Focus Manually  
(☞ P48 [Focus Operation] )

Memo : \_\_\_\_\_

- If both the slots are loaded with recordable cards in the factory default, pressing the [REC] button starts recording only to the media in the selected slot.

When [Main Menu] → [System] → [Record Set] → [Slot Mode] is set to "Dual", recording can be performed simultaneously to the cards in both the slots.

- (☞ P74 [Dual Rec] )
- The tally lamp can be turned off in [System] → [Tally Lamp].  
(☞ P110 [Tally Lamp] )

- 3 Check the most recently captured images.**

- Press the [C.REVIEW/7] button on the lens to activate the Clip Review function. The most recently captured images are played back on the LCD monitor and viewfinder screen.
- After playback, the camera recorder returns to standby mode (STBY).  
(☞ P72 [Viewing Recorded Videos Immediately (Clip Review)] )

Memo : \_\_\_\_\_

- [Clip Review] is assigned to [C.REVIEW/7] button in factory default.
- [Clip Review] can also be assigned to other user buttons.  
(☞ P38 [Assigning Functions to User Buttons] )

# Selecting System Definition, File Format and Video Format

You can select the resolution of the recorded videos (HD, SD, or Web), file format for recording/playback, and the video recording format on this camera recorder.

Memo : \_\_\_\_\_



- Make a selection in [Main Menu] → [Record Format].

## Selecting a System Definition

There are three different definitions for selection.

- HD:  
Records in HD (High Definition) quality.
- SD:  
Records in SD (Standard Definition) quality.
- Web:  
Records in low definition quality

You can select a definition for the recorded images from the following items under [System].

- HD:  
Records in HD quality for both slots A and B.
- SD:  
Records in SD quality for both slots A and B.
- HD+SD:  
Records in HD quality for slot A, and SD quality for slot B.  
( P73 [Recording Simultaneously at Two Different Definitions] )
- HD+Web:  
Records in HD quality for slot A, and Web quality for slot B.  
( P73 [Recording Simultaneously at Two Different Definitions] )

## Selecting a File Format

Select a file format in [**A**Format]/[**B**Format].  
There are five file formats for selection.

- QuickTime(MPEG2):  
QuickTime file format (.MOV)
- MP4(MPEG2):  
MP4 file format
- MXF(MPEG2):  
MXF (material exchange format)
- AVCHD:  
AVCHD file format
- QuickTime(H.264):  
QuickTime format (.MOV)

Memo : \_\_\_\_\_

- The available options vary as follows depending on the [System] setting.
  - When “HD”, “HD+SD”, or “HD+Web” is set, the options for slot A are:  
QuickTime(MPEG2), MP4(MPEG2), MXF(MPEG2), AVCHD, QuickTime(H.264)
  - When “SD” or “HD+SD” is set, the available option for slot B is:  
QuickTime(H.264)
  - When “HD+Web” is set, the available option for slot B is:  
QuickTime(H.264)

## Selecting a Video Format

- Select a [Record Format] from the list of formats.  
The selectable [**A**Frame & Bit Rate]/[**B**Frame & Bit Rate] changes according to the settings of [System], [**A**Format], and [**A**Resolution].
- The recording bit rate (video) is 35 Mbps VBR in “HQ” mode, and 18.3 Mbps (1080i is 25 Mbps) CBR in “SP” mode.
- If [**A**Format]/[**B**Format] is set to “AVCHD”, the recording bit rate (system rate) is 24 Mbps VBR in “HQ” mode, and 17 Mbps VBR in “SP” mode.

## List of Formats

The following is a list of file formats and video formats that can be selected on this camera recorder.

- When [System] is set to “HD”, “HD+SD”, or “HD+Web”, the options for slot A are:

Record Format			Remarks
Format	Resolution	Frame & Bit Rate	
QuickTime MP4 MXF (MPEG2)	1920x1080	60i(HQ)	
		30p(HQ)	
		50i(HQ)	
		25p(HQ)	
		24p(HQ)	
		60i(HQ)	
	1440x1080	50i(HQ)	
		60i(SP)	HDV compatible
		50i(SP)	HDV compatible
	1280x720	60p(HQ)	
		30p(HQ)	
		50p(HQ)	
		25p(HQ)	
24p(HQ)			
60p(SP)		HDV compatible	
50p(SP)		HDV compatible	
AVCHD	1920x1080	60i(HQ)	Recordable using Class 4
		50i(HQ)	
		60i(SP)	
		50i(SP)	
QuickTime (H.264)	1920x1080	60i(UHQ)	
		50i(UHQ)	
		24p(UHQ)	

Memo : \_\_\_\_\_

- The “1280x720” setting is not available for MXF files.
- When “HD+SD” is selected, [Frame & Bit Rate] cannot be selected.
  - U model:  
50i(HQ), 50i(SP), 50i(UHQ), 50p(SP), 25p(HQ)
  - E model:  
60i(HQ), 60i(SP), 60i(UHQ), 30p(HQ), 24p(HQ), 24p(UHQ)

- When [System] is set to “SD” or “HD+SD”, the available options for slot B are as follows. The video format is fixed as follows according to the model.

Record Format			Remarks
Format	Resolution	Frame & Bit Rate	
QuickTime (H.264)	720 x 480	60i (U model)	Recordable using Class 4
	720 x 576	50i (E model)	

- Options for slot B when [System] is set to “HD+Web”:

Record Format			Remarks
Format	Resolution	Frame & Bit Rate	
QuickTime (H.264)	480x270	30p(LP)	Recordable using Class 4
		25p(LP)	
		24p(LP)	

Memo : \_\_\_\_\_

- [Frame & Bit Rate] is fixed depending on the [Frame & Bit Rate] setting for slot A.

## Selecting the Aspect Ratio of SD Videos

For selecting the aspect ratio for the SD image when [System] is set to “SD” or “HD+SD”. You can select “16:9” or “4:3”.

Memo : \_\_\_\_\_

- When [System] is set to “HD” or “HD+Web”, aspect ratio is fixed at “16:9”.

## Setting the Record Format Menu

- Display the [Main Menu] → [Record Format] menu.
- Set each of the items.
- After setting is complete for all items, press the [FOCUS ASSIST/1] button.
  - The record format is switched.
  - A “Please Wait...” message appears on the screen during switching.

# Zoom Operation

Adjusts the angle of view.

Zoom ratio: 1x to 23x (optical zoom only)

Zooming can be operated using any of the three levers/rings below.

- Zoom Lever at the Grip
- Zoom Lever at the Handle
- Zoom Ring at the Lens Section:

Functions as a zoom ring when the [ZOOM SERVO/MANUAL] switch is set to "MANUAL".

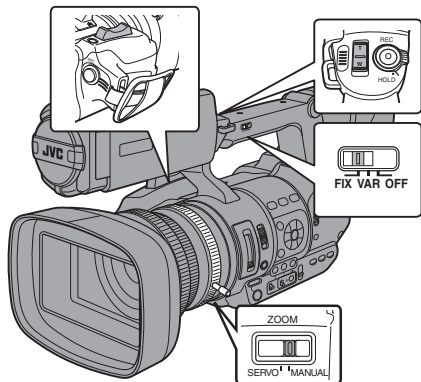

## Using the Zoom Lever at the Grip

- 1 Set the [ZOOM SERVO/MANUAL] switch to "SERVO".
- 2 Press the zoom lever to zoom.
  - The zoom speed changes according to the extent the zoom lever is being pushed.
  - Zooms into wide angle and increases the angle of view when "W" is pressed.
  - Zooms into telephoto and decreases the angle of view when "T" is pressed.
  - A zoom bar appears during zoom operation

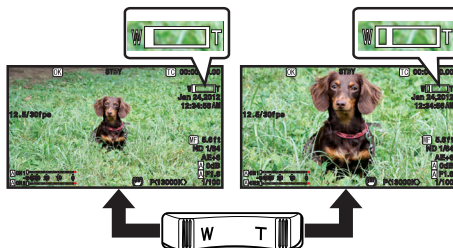

## Using the Zoom Lever at the Handle

- 1 Set the [ZOOM SERVO/MANUAL] switch to "SERVO".
- 2 Set the [FIX/VAR/OFF] zoom speed switch to "FIX" or "VAR".

Memo : \_\_\_\_\_

- Setting to "FIX" will allow the zoom operation to move at the speed set in [Handle Zoom Speed].
  - Set the zoom speed using [Main Menu] → [Camera Function] → [Handle Zoom Speed]. (P96 [ Handle Zoom Speed ])
- Setting to "VAR" will change the zoom speed according to the pressure applied on the lever.

- 3 Press the zoom lever at the handle to zoom.

Memo : \_\_\_\_\_

- When the [FIX/VAR/OFF] zoom speed switch is set to "OFF", the zoom lever at the handle section cannot be used.

## Using Zoom Ring at the Lens Section

- 1 Set the [ZOOM SERVO/MANUAL] switch to “MANUAL”.

You can adjust the preferred angle of view by turning the zoom ring.

## Saving/Recalling Current Zoom Position (Preset Zoom)

This allows you to register up to three zoom positions.

- 1 Assign the “Preset Zoom1”, “Preset Zoom2”, or “Preset Zoom3” function to any of the user buttons.  
(☞ P38 [Assigning Functions to User Buttons])  
(☞ P97 [USER1 - USER7, LCD KEY▲/LCD KEY▶/LCD KEY▼/LCD KEY◀])
- 2 Save the current zoom position.
  - Press any of the buttons assigned with the “Preset Zoom1”, “Preset Zoom2”, or “Preset Zoom3” function for more than 1 second.
  - The current zoom position will be stored.
- 3 Recall the stored zoom position.
  - Press any of the buttons assigned with the “Preset Zoom1”, “Preset Zoom2”, or “Preset Zoom3” function and release within 1 second.
  - The camera recorder zooms to the stored zoom position.

Memo : \_\_\_\_\_

- To recall the stored zoom position, set the [ZOOM SERVO/MANUAL] switch to “SERVO”.
- The zoom speed to the zoom position can be set with [Main Menu] → [Camera Function] → [Preset Zoom Speed].  
(☞ P98 [Preset Zoom Speed])
- Operating other zoom maneuvers during a zoom position recall will cancel the recall.

## Focus Operation

### Adjusting Focus Manually

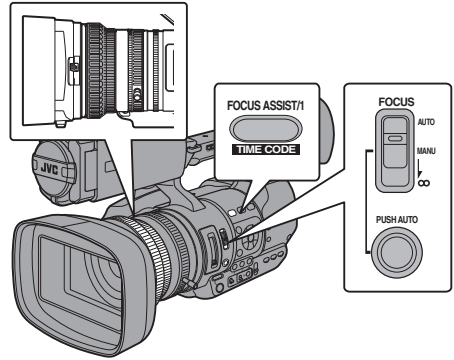

- 1 Set the [FOCUS AUTO/MANU/∞] switch to “MANU”.

The manual focus icon **MF** appears on the screen.

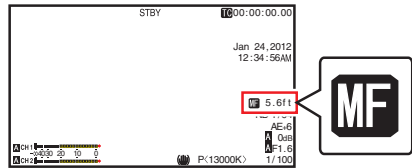

Memo : \_\_\_\_\_

- If [Main Menu] → [LCD/VF] → [Display Settings] → [Focus] is set to “Off”, the **MF** icon will not appear.  
(☞ P105 [Focus])

### 2 Turn the focus ring to adjust the focus.

Memo : \_\_\_\_\_

- Using the Focus Assist function makes it easier to focus.  
(☞ P49 [Focus Assist Function])
- Pressing the [FOCUS AUTO] button in the Manual Focus mode activates the One-push Auto Focus mode, while holding down the [FOCUS AUTO] button activates the Push Auto Focus mode.  
(☞ P49 [One Push Auto Focus])  
(☞ P49 [Setting to Auto Focus Temporarily (Push Auto Focus)])

## Adjusting Focus Automatically

Set the [FOCUS AUTO/MANU/∞] switch to "AUTO".

The auto focus icon  appears on the screen.

Memo : \_\_\_\_\_

- If [AF Assist] is set to "On", you can temporarily adjust the focus manually by turning the focus ring when in the automatic focus adjustment mode.

( P96 [ AF Assist ] )

- If [Main Menu] → [LCD/VF] → [Display Settings] → [Focus] is set to "Off", the auto focus icon will not appear.

( P105 [ Focus ] )

## One Push Auto Focus

While in the Manual Focus mode, pressing the [PUSH AUTO] button (within 1 minute) makes the camera recorder focus on the center of the frame automatically.

Memo : \_\_\_\_\_

- Face detection does not work during One Push Auto Focus.
- When the operation is complete, the camera recorder returns to the Manual Focus mode automatically.
- One Push Auto Focus functions with emphasis on the focusing speed. This function is not suitable during recording.

## Setting to Auto Focus Temporarily (Push Auto Focus)

- The camera recorder will shift to Auto Focus mode temporarily and automatically adjusts focus when the [PUSH AUTO] button is pressed during shooting in Manual Focus mode.
- Release the [PUSH AUTO] button to return to Manual Focus mode.

Memo : \_\_\_\_\_

- Face detection does not work during Push Auto Focus.

## Adjusting Focus on Far Objects



Slide the [FOCUS AUTO/MANU/∞] switch to "∞".

- The ∞ icon is displayed.
- Release your finger to return to Manual Focus mode.

## Focus Assist Function

- When the [FOCUS ASSIST/1] button is pressed during shooting, the focused area is displayed in color. This enables easy and accurate focusing.
- Select the color (blue, red or green) in the menu.

Memo : \_\_\_\_\_

- When [Main Menu] → [LCD/VF] → [Shooting Assist] → [Focus Assist] → [Type] is set to "ACCU-Focus", the depth of field becomes shallower to enable easier focusing. ( P104 [ Focus Assist ] )
- The "ACCU-Focus" function switches automatically to "Off" after about 10 seconds.
- Select the display color in [Main Menu] → [LCD/VF] → [Shooting Assist] → [Focus Assist] → [Color]. ( P104 [ Color ] )
- If you use the zebra function and the Focus Assist function at the same time, it may be difficult to see the effect of the Focus Assist. In this case, turn off the zebra function.

## Setting Focus Assist Function to a User Button

You can assign the "Focus Assist" function to a user button.

( P38 [Assigning Functions to User Buttons] )

# Adjusting the Focusing by Face Detection

This function detects human faces and automatically adjusts focus during Auto Focus. It can also track moving objects. When several faces are detected, you can select one to focus on.

Memo : \_\_\_\_\_

- This function can also adjust the brightness automatically according to the brightness of the face detected.  
(☞ P97 [ Face Detect ] )

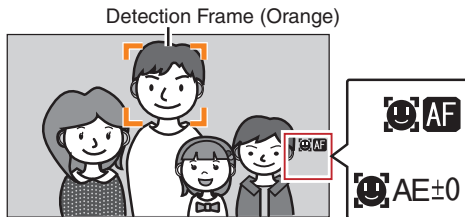
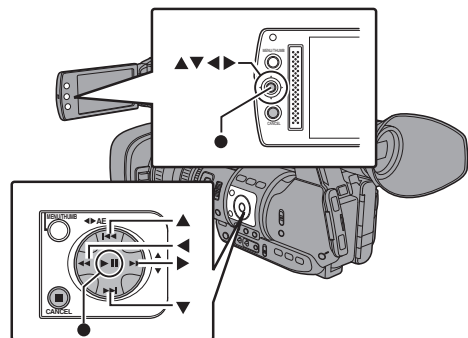

Memo : \_\_\_\_\_

- If the detection frame does not appear, make sure that the [FOCUS AUTO/MANU/∞] selection switch has been set to "AUTO". And if [Face Detect] is set to "AF&AE", set one or more of the items (Gain, Iris and Electronic Shutter) to the automatic adjustment mode.  
(☞ P51 [Adjusting the Brightness Automatically] )  
(☞ P52 [Auto Iris (Automatic Adjustment Mode)] )  
(☞ P53 [Automatic Gain Mode (Automatic Gain Adjustment)] )  
(☞ P56 [Automatic Shutter Mode (Automatic Shutter Adjustment)] )

## 1 Assign the "Face Detect" function to any of the user buttons.

(☞ P38 [Assigning Functions to User Buttons] )

## 2 Focus the camera recorder on a person and press the user button that is assigned with "Face Detect".

- When Face detection is enabled, the face detection icon (👤) appears.
  - When [Main Menu] → [Camera Function] → [User Switch Set] → [Face Detect] is set to "AF", "👤 AF" appears.
  - When [Main Menu] → [Camera Function] → [User Switch Set] → [Face Detect] is set to "AF&AE", "👤 AE±0" appears.
- If you select the person nearest to the center of the screen, an orange frame will appear on his face.
- Focus will be automatically adjusted for the selected person.

## Selecting Specific Person from Several Persons

### 1 Hold down the user button that is assigned with "Face Detect".

- The camera recorder will enter face selection mode and the face detection icon (👤) will blink.
- An orange frame will appear on the face of the person nearest to the center of the screen. Blue frames will appear on the faces of others.

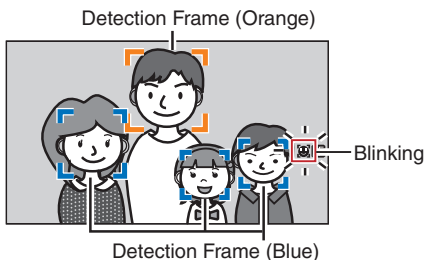

### 2 Select a specific person.

- Use the cross-shaped button (◀▶▲▼) to select a person.
- An orange frame will appear on the face of the selected person and focus will be automatically adjusted.

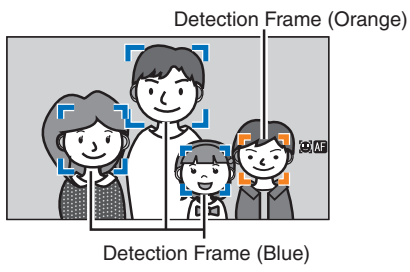

**3 Press the Set button (●) to confirm the person for face detection.**

- Memo : \_\_\_\_\_
- Press the [CANCEL] button to cancel the selection.
  - You can specify the detection sensitivity and the operation speed after losing sight of the face using [Main Menu] → [Camera Function] → [User Switch Set] → [Face Detect] → [Sensitivity] and [Hysteresis].  
(☞ P97 [ Sensitivity ] )  
(☞ P98 [ Hysteresis ] )

## Adjusting the Brightness

Adjust the brightness using Iris, Gain, Shutter speed and ND filter according to the brightness of the object.

### Adjusting the Brightness Automatically

When the [FULL AUTO] switch is set to "ON", Iris, Gain, Shutter speed and ND filter are automatically adjusted according to the brightness of the object to maintain optimum brightness.

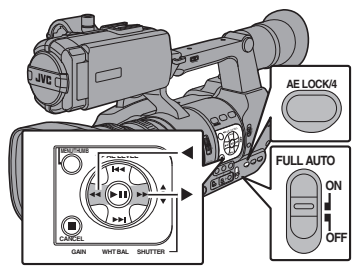

Memo : \_\_\_\_\_

- You can use the cross-shaped button (◀▶) on the side of the camera recorder to set the target level (brighter/darker) to maintain optimum brightness during automatic adjustment.  
(☞ P95 [ AE Level ] )
- The convergence speed of the automatic adjustment for gain, shutter and iris can be set in the menu.  
(☞ P95 [ AE Speed ] )
- If one or more of the items (Gain, Iris and Shutter) have been set to "Auto", the value of the corresponding items when the user button that is assigned "AE Lock" is pressed can be fixed.  
(☞ P98 [ AE Lock ] )

### Adjusting the Brightness Manually

When the [FULL AUTO] switch is set to "OFF", some or all of the items (Iris, Gain and Shutter Speed) can be manually adjusted.  
(☞ P52 [Adjusting the Iris] )  
(☞ P53 [Setting the Gain] )  
(☞ P54 [Setting the Electronic Shutter] )

Memo : \_\_\_\_\_

- If Iris, Gain and Shutter Speed are manually adjusted, the [AE Level] setting is temporarily disabled.

# Adjusting the Iris

You can adjust the aperture of the lens iris manually or automatically according to the brightness of the object.

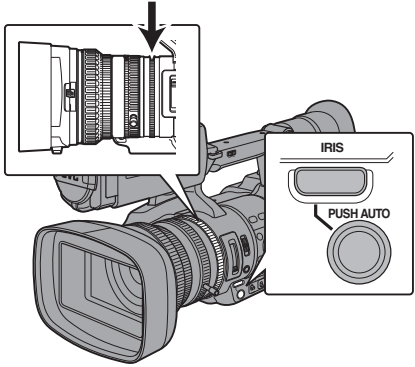

## Auto Iris (Automatic Adjustment) Mode

Press the [IRIS] button to set to the Auto Iris mode. The iris is automatically adjusted according to the brightness of the object. The **A** icon appears on the screen.

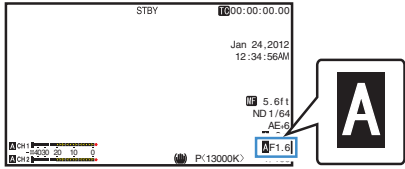

## Manual Iris (Manual Adjustment) Mode

The aperture value (F-number) of the lens can be set manually.

- 1 Press the [IRIS] button to set to the Manual Iris mode.  
The **A** icon on the screen disappears.
- 2 Turn the iris ring on the lens to adjust the iris manually.

The open F-number of the aperture varies according to the zoom position.  
Wide [W] end : F1.6  
Tele [T] end : F3.0

F-number	Description
Decrease	The subject appears brighter. The focused range becomes sharper, while the background is blurred to produce a soft image.
Increase	The subject appears darker. Background of image becomes focused as well.

- Memo : \_\_\_\_\_
- Pressing the [PUSH AUTO] button during Manual Iris mode activates One Push Auto Iris mode. And holding down the [PUSH AUTO] button activates Push Auto Iris mode.

Memo : \_\_\_\_\_

- Set the [FULL AUTO] switch on the camera recorder to "ON" to enter Auto Iris mode (automatic adjustment mode). The iris is automatically adjusted according to the brightness of the object. In this case, the [IRIS] switch on the camera recorder is disabled.
- The iris open/close limit can be set in [Main Menu] → [Camera Function] → [Auto Iris Limit (OPEN)] / [Auto Iris Limit (CLOSE)] during Auto Iris.  
(☞ P96 [ Auto Iris Limit (OPEN) ] )  
(☞ P96 [ Auto Iris Limit (CLOSE) ] )
- You can use the cross-shaped button (◀▶) on the side control panel to set the target level (brighter/darker) of the auto iris.  
(☞ P95 [ AE Level ] )
- The convergence speed of the auto iris can be set in the menu.  
(☞ P95 [ AE Speed ] )

## One Push Auto Iris

When the camera recorder is in Manual Iris mode, press the [PUSH AUTO] button to adjust the iris according to the brightness of the object.

## Push Auto Iris

When the camera recorder is in Manual Iris mode, hold down the [PUSH AUTO] button to change to Auto Iris mode temporarily. The iris will be automatically adjusted according to the brightness of the object.

# Setting the Gain

This function electrically boosts the light sensitivity when there is insufficient illumination on the object. You can set the gain of the video amplifier according to the brightness of the object. Select the setting mode according to your shooting conditions.

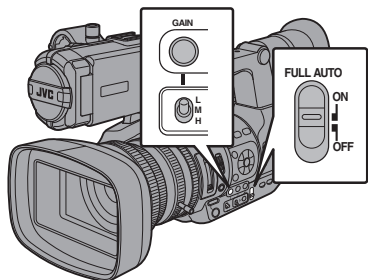

## Automatic Gain Mode (Automatic Gain Adjustment)

### 1 Press the [GAIN] button to set to the Automatic Gain mode (ALC).

The **A** icon appears on the screen.

Memo : \_\_\_\_\_

- Set the [FULL AUTO] switch on the camera recorder to "ON" to enter the Automatic Gain mode ([ALC] fixed). The gain of the video amplifier is automatically set according to the brightness of the object. In this case, the [GAIN] switch on the camera recorder is disabled.

Memo : \_\_\_\_\_

- The upper limit of the gain setting value during ALC operation can be set in [Main Menu] → [Camera Function] → [ALC Limit].  
(P96 [ ALC Limit ])

## Manual Gain Mode (Manual Gain Switching)

### 1 Press the [GAIN] button to set to the Manual Gain mode.

- The **A** icon on the screen disappears.
- Use the [L/M/H] switch to set the gain of the selected video amplifier.
- The default positions of the switch are as follows.

[L] : 0dB

[M] : 6dB

[H] : 12dB

Memo : \_\_\_\_\_

- You can change the gain value of each position in the menu. Increasing the sensitivity causes the screen to appear grainier.

(P96 [GAIN L/GAIN M/GAIN H])

# Setting the Electronic Shutter

You can change the shutter speed (time for each shooting frame) using the electronic shutter function. Electronic shutter can be adjusted manually or automatically.

## Manual Shutter Mode (Manual Shutter Switching)

- Press the [SHUTTER] button to set to the Manual Shutter mode.
  - The **A** icon on the screen disappears.
  - Use the Set button (●) to switch between the shutter modes and the cross-shaped button (▲▼) to switch between the speeds.

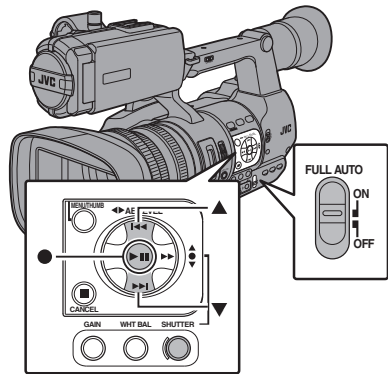

## Switching Shutter Mode

Press the Set button (center of the cross-shaped button) to turn ON/OFF the shutter.

- Memo : \_\_\_\_\_
- When the shutter is ON, “Step” or “Variable” may be selected in [Camera Function] → [Shutter]. “Step” is the factory default. (P95 [ Shutter ] )

## Switching Shutter Speed

When shutter is ON, use the cross-shaped button (▲▼) to set the shutter speed. Shutter speed differs according to the video format and variable frame rate settings.

- Memo : \_\_\_\_\_
- To display Shutter in angle (DEG), set [Frame & Bit Rate] to “24p(UHQ)”, “24p(HQ)” or “25p(HQ)”, and set [Shutter] in [LCD/ VF] → [Display Settings] to “DEG”. (P112 [ Frame & Bit Rate ] ) (P106 [ Shutter ] )

## During Modes Other Than Variable Frame Rec

Shutter	Resolution/ Frame & Bit Rate	720/60p 720/30p 1080/60i 1080/30p	720/50p 720/25p 1080/50i 1080/25p	720/24p 1080/24p
▲ ON (Step)		—	—	1/10000 1/4000 1/2000
		1/10000	1/10000	1/1000
		1/4000	1/4000	1/500
		1/2000	1/2000	1/250
		1/1000	1/1000	1/120
		1/500	1/500	1/100
		1/250	1/250	1/60
		1/120	1/120	1/54
		1/100	1/100	1/50
	(Standard)	1/60	1/50	1/48
		1/30	1/25	1/24
		1/15	1/12.5	1/12
		1/7.5	1/6.25	1/6
▲ ON (Variable)	(Upper limit)	1/10227		1/10843
	Default values	1/60.13	1/50.09	1/48.09
		~		
	(Lower limit)	1/30.07	1/25.05	1/24.05
▼ OFF		1/60	1/50	1/48

- Memo : \_\_\_\_\_
- The operations of the cross-shaped button (▲▼) and Set button (●) are disabled in the following cases.
    - During clip preview
    - During display of the USB switching confirmation screen
    - During display of the formatting confirmation screen
    - When selecting a face using face detection
    - When selecting a photometry area with [Spot Meter] set to “Manual”

## During Variable Frame Rec

	Shutter	Resolution/ Frame & Bit Rate	720/30p, 720/24p, 1080/30p, 1080/24p								
			Frame Rate	60, 30, 15	54, 27	50, 25	48, 24, 12, 6	45, 22.5	40, 20, 10	36, 18	32, 2
▲	ON (Step)		—	—	—	—	—	—	—	—	1/10000
			—	—	—	—	—	—	1/10000	1/4000	1/4000
			—	—	—	—	—	—	1/10000	1/4000	1/2000
			—	—	—	—	—	1/10000	1/4000	1/2000	1/1000
			—	—	—	—	1/10000	1/4000	1/2000	1/1000	1/500
			—	—	1/10000	1/4000	1/2000	1/1000	1/500	1/250	1/250
			—	1/10000	1/4000	1/2000	1/1000	1/500	1/250	1/120	1/120
			1/4000	1/2000	1/1000	1/500	1/250	1/120	1/100	1/60	1/60
			1/2000	1/1000	1/500	1/250	1/120	1/100	1/60	1/54	1/54
			1/1000	1/500	1/250	1/120	1/100	1/60	1/54	1/50	1/50
			1/500	1/250	1/120	1/100	1/60	1/54	1/50	1/48	1/48
			1/250	1/120	1/100	1/60	1/54	1/50	1/48	1/45	1/45
			1/120	1/100	1/60	1/54	1/50	1/48	1/45	1/40	1/40
			1/100	1/60	1/54	1/50	1/48	1/45	1/40	1/36	1/36
			(Standard)	1/60	1/54	1/50	1/48	1/45	1/40	1/36	1/32
▼			1/30	1/27	1/25	1/24	1/22.5	1/20	1/18	1/16	
			1/15	1/13.5	1/12.5	1/12	1/11.25	1/10	1/9	1/8	
			1/7.5	1/6.75	1/6.25	1/6	1/5.625	1/5	1/4.5	1/4	
▲	ON (Variable)	(Upper limit)	1/10227			1/10843	1/10227	1/10843	1/10227	1/10843	
		(Lower limit)	1/60.13			1/54.10	1/50.09	1/48.09	1/45.07	1/40.07	1/36.05
▼	OFF		1/60	1/54	1/50	1/48	1/45	1/40	1/36	1/32	

Shooting

	Shutter	Resolution/ Frame & Bit Rate	1080/25p 720/25p								
			Frame Rate	50, 25, 12.5	48, 24, 6	45, 22.5	40, 20, 10	36, 18	32, 2		
▲	ON (Step)		—	—	—	—	—	—	1/10000		
			—	—	—	—	—	1/10000	1/4000	1/4000	
			—	—	—	—	1/10000	1/4000	1/2000	1/2000	
			—	—	—	1/10000	1/4000	1/2000	1/1000	1/1000	
			—	1/10000	1/4000	1/2000	1/1000	1/500	1/250	1/250	
			1/4000	1/2000	1/1000	1/500	1/250	1/120	1/100	1/100	
			1/2000	1/1000	1/500	1/250	1/120	1/100	1/50	1/50	
			1/1000	1/500	1/250	1/120	1/100	1/50	1/48	1/48	
			1/500	1/250	1/120	1/100	1/50	1/48	1/45	1/45	
			1/250	1/120	1/100	1/50	1/48	1/45	1/40	1/40	
			1/100	1/50	1/48	1/45	1/40	1/36	1/36	1/36	
			(Standard)	1/50	1/48	1/45	1/40	1/36	1/32	1/32	
			▼			1/25	1/24	1/22.5	1/20	1/18	1/16
						1/12.5	1/12	1/11.25	1/10	1/9	1/8
						1/6.25	1/6	1/5.625	1/5	1/4.5	1/4
▲	ON (Variable)	(Upper limit)	1/10227		1/10843	1/10227	1/10843	1/10227	1/10843		
		(Lower limit)	1/50.09		1/48.09	1/45.07	1/40.07	1/36.05	1/32.04		
▼	OFF		1/50	1/48	1/45	1/40	1/36	1/32			

## Automatic Shutter Mode (Automatic Shutter Adjustment)

- 1 Press the [SHUTTER] button or set the [FULL AUTO] switch to "ON" to enter Automatic Shutter mode.

- The **A** icon appears on the screen.
- The camera recorder enters the Automatic Shutter mode. The shutter speed is automatically adjusted according to the brightness of the object.

Memo : \_\_\_\_\_

- Switching of shutter speed with the cross-shaped button (▲▼) and switching of shutter mode with the Set button (●) are disabled.

## Setting the ND Filter

Use the ND filter to keep the lens aperture in the appropriate range. Switch according to the brightness of the object. When the position on the switch is changed, the selected position of the ND filter is displayed on the LCD monitor and viewfinder screen. (Display 2 screen)

Memo : \_\_\_\_\_

- When [Main Menu] → [LCD/VF] → [Display Settings] → [ND Filter] is set to "Off", the position of the ND filter will not be displayed. (☞ P105 [ ND Filter ])

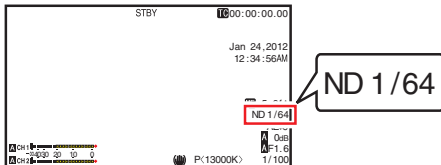
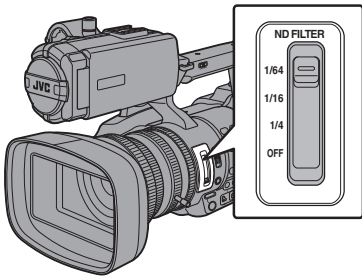

Memo : \_\_\_\_\_

- It is recommended to use the ND filter to set the lens aperture to less than F8.

## Adjusting the White Balance

Adjust the white balance according to the color temperature of the lighting. You can select the adjustment mode according to the shooting conditions.

As the color of the light (color temperature) varies according to the light source, it is necessary to readjust the white balance when the main light source illuminating the object changes.

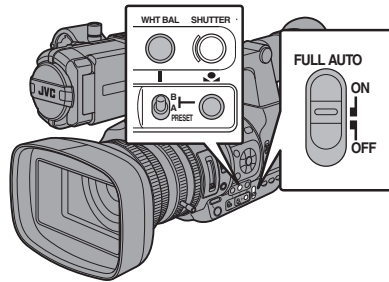

## Manual White Balance Mode (Manual Switching)

- 1 Press the [WHT BAL] button to set to Manual White Balance mode.

- You can select the white balance with the [WHT BAL B/A/PRESET] selection switch.
- Use the [WHT BAL B/A/PRESET] selection switch to select "PRESET" (preset mode), "A" (memory A mode), or "B" (memory B mode).
- The value assigned to the switch appears on the screen.

Memo : \_\_\_\_\_

- This is fixed at "FAW" when the [FULL AUTO] switch of the camera recorder is set to "ON".

## Preset Mode (PRESET)

- Two different color temperature settings are registered on this camera recorder. You can switch between them using the [↕] button. (Default setting: “3200K” ↔ “5600K”)
- Press the [↕] button to switch to a different color temperature. (“Preset Temp.” ↔ “Alternative Temp.”)

- 1 Set the [WHT BAL B/A/PRESET] switch to “PRESET”.
- 2 Press the [↕] button.

### Setting the [Preset Temp.] or [Alternative Temp.] Values

You can change both the color temperature settings in the Preset mode in the menu.

- 1 Open the [Preset Temp.] or [Alternative Temp.] menu.
  - Select [Main Menu] → [Camera Process] → [White Balance] → [Preset Temp.] and [Alternative Temp.], and press the Set button (●).
  - The Color Temperature setting screen appears.

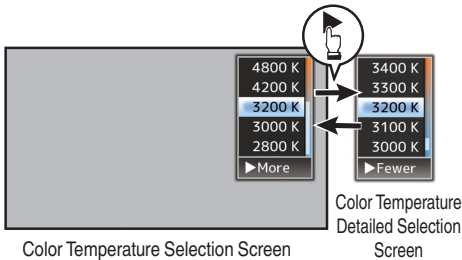

## 2 Select the color temperature.

- When selecting from a setting value (Color Temperature Selection screen), use the cross-shaped button (▲▼) to select the color temperature. [Setting Values: 7500K, 6500K, 5600K, 5200K, 4800K, 4200K, ●3200K, 3000K, 2800K]
- To select detailed values (Color Temperature Detailed Selection screen)
  - Press the cross-shaped button (▶) to display the Color Temperature Detailed Selection screen.
  - Use the cross-shaped button (▲▼) to select a color temperature. [Setting Values: 2300K to 15000K (in 100K increments)]

Memo : \_\_\_\_\_

- Use the cross-shaped button (▶) to switch between the Color Temperature Selection screen and the Color Temperature Detailed Selection screen.
- If [White Balance] has been assigned to the user button, pressing the assigned user button will display the Color Temperature Selection screen. (☞ P38 [Assigning Functions to User Buttons])

## Memory A Mode (A), Memory B Mode (B)

- Set to the white balance saved in Memory A or Memory B.
- When the [WHT BAL B/A/PRESET] selection switch is set to “A” or “B”, press the [↕] button to execute white balance. The white balance will be automatically adjusted and the adjusted value will be saved in Memory A or Memory B.

### 1 Prepare the camera recorder.

- ① Set the [POWER ON/OFF(CHG)] switch to “ON”.
- ② Press the [IRIS] button to set to the Auto mode.
- ③ Set the [FULL AUTO] switch to “OFF”.

### 2 Set the [ND FILTER] switch according to the lighting.

(☞ P56 [Setting the ND Filter])

### 3 Set the [WHT BAL B/A/PRESET] selection switch to “A” or “B”.

### 4 Locate a place with similar lighting conditions as the object to be shot, place a white object near the center of the screen and zoom in to fill the screen with white.

### 5 Press the [↕] (Auto White Balance) button.

- The white detection frame appears when Auto White Balance is activated. Fill the frame with white completely.
- “AUTO WHITE A OPERATION” or “AUTO WHITE B OPERATION” appears on the viewfinder when Auto White Balance is activated.
- When the correct white balance is achieved, “AUTO WHITE A OK” or “AUTO WHITE B OK” appears for about 3 seconds together with the approximate color temperature.

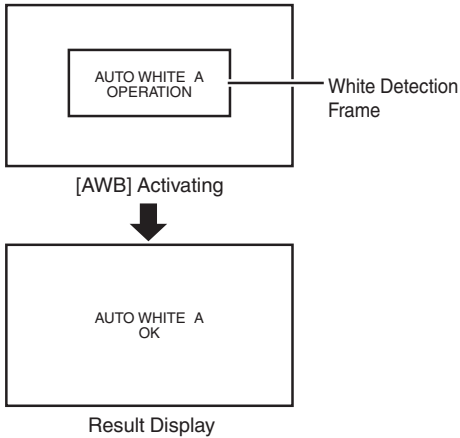

Caution :

- Do not use highly reflective objects, such as metals. Doing so may result in improper white balance adjustment.
- The Auto White function cannot provide optimum white balance with an object outside the adjustment range, for example when it contains only a single color or not enough white color.

### Error Message

If the white balance adjustment is not correctly completed, one of the following messages will appear for about 3 seconds.

Message	Status
NG : OBJECT	The object used is defective. Displayed when there is not enough white color on the object, or when the color temperature is not suitable. Use another white object and adjust the white balance again.
ERROR : LOW LIGHT	Insufficient illumination. Displayed when the lighting is dark. Increase the lighting and adjust the white balance again.
ERROR : OVER LIGHT	Excessive illumination. Displayed when the lighting is too bright. Decrease the lighting and adjust the white balance again.

### White Paint Adjustment

You can fine-tune the white balance saved in Memory A or Memory B.

- 1 **Select [Main Menu] → [Camera Process] → [White Balance] → [AWB Paint] and press the Set button (●).**

The White Paint Adjustment screen appears.

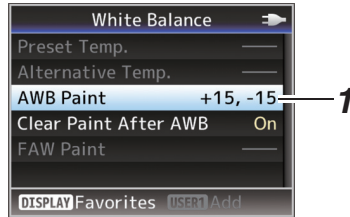

- 2 **Adjust the R and B values.**

Use the cross-shaped button (▲▼) to adjust R value and (◀▶) to adjust B value.



- 3 **Press the Set button (●).**

Returns to the [White Balance] screen.

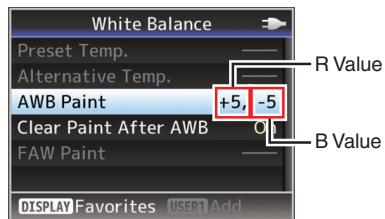

Memo :

- Selecting [●] will usually clear the White Paint Adjustment value. But when [Main Menu] → [Camera Process] → [White Balance] → [Clear Paint After AWB] is set to "Off", values will not be cleared even when [●] is selected. (P102 [Clear Paint After AWB])
- If [White Balance] has been assigned to the user button, pressing the assigned user button will display the AWB Paint Adjustment screen. (P38 [Assigning Functions to User Buttons])

## Automatic White Balance Mode (FAW: Fulltime Auto White balance)

- Press the [WHT BAL] button on the side control panel to enter into Automatic White Balance mode.
- “<FAW>” appears on the screen.
- Set the [FULL AUTO] switch on the camera recorder to “ON” to enter Automatic White Balance mode. An appropriate white balance is automatically adjusted according to the color temperature of the lighting on the object.
- White balance switching with the [WHT BAL B/A/PRESET] selection switch is disabled.

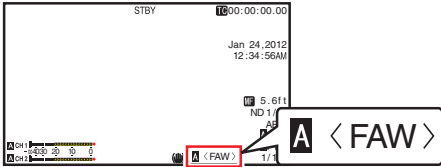

**Caution :**

- The accuracy of [FAW] is inferior to that of Auto White Balance.
- When the power of the camera recorder is turned on with the [FAW] mode selected, it takes about 15 seconds for the colors to stabilize.

**Memo :**

- When [Main Menu] → [Camera Function] → [User Switch Set] → [AE Lock] is set to “AE/WB”, the white balance when the user button that is assigned [AE Lock] is pressed can be fixed. (P98 [ AE Lock ] )
- If [White Balance] has been assigned to the user button, pressing the assigned user button will display the FAW Paint Adjustment screen. (P38 [Assigning Functions to User Buttons] )

## FAW Paint Adjustment

You can fine-adjust the white balance that was automatically adjusted.

- 1 **Select [Main Menu] → [Camera Process] → [White Balance] → [FAW Paint] and press the Set button (●).**

The FAW Paint Adjustment screen appears.

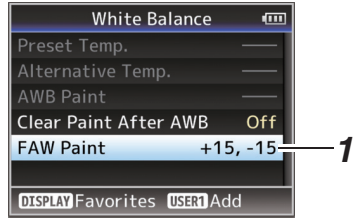

- 2 **Adjust the R and B values.**

Use the cross-shaped button (▲▼) to adjust R value and (◀▶) to adjust B value.



- 3 **Press the Set button (●).**

Returns to the [White Balance] screen.

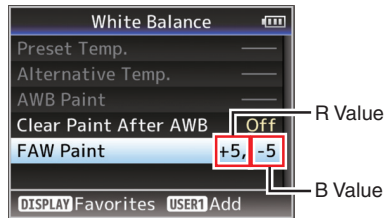

## Adjusting the Camera Image

The picture quality of the camera can be set using the [Camera Process] menu.

As the adjustments are shown on the screen, you can adjust the values while checking the picture quality on the camera.

- [Detail]
- [Master Black]
- [Black Toe]
- [Knee]
- [White Clip]
- [Gamma]
- [WDR]
- [White Balance]
- [Color Matrix]
- [Color Gain]
- [Reverse Picture]
- [Shooting Mode]

Memo : \_\_\_\_\_

- For details of the respective items, see the [Camera Process] menu.  
(☞ P98 [Camera Process Menu] )

## Using the Image Stabilizer

Reduces blurring of images due to camera shake.

### 1 Check whether the image stabilizer feature is turned ON or OFF.

If the image stabilizer icon (👉) does not appear on the screen display, the image stabilizer function is OFF.

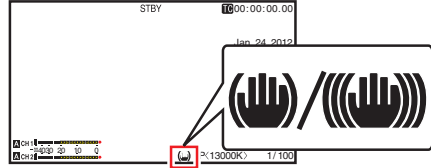

### 2 Press the [OIS/2] button to turn ON the image stabilizer feature (when image stabilizer feature is OFF).

The image stabilizer feature switches between ON and OFF with every press of the [OIS/2] button.

- OFF:  
Use this setting when the camera recorder is secured, such as when using a tripod.
- ON:  
Reduces blurring of images due to camera shake.

Memo : \_\_\_\_\_

- Select [Main Menu] → [Camera Function] → [OIS] → [Level] to set the correction level.  
(☞ P95 [Level] )
- Correction by this feature may not be sufficient when camera shake is too strong.
- “OIS” is assigned to [OIS/2] button in factory default.
- “OIS” can also be assigned to other user buttons.  
(☞ P38 [Assigning Functions to User Buttons] )

# Audio Recording

You can record audio from the two channels (CH1/CH2) in synchronization with video images on this camera recorder.

Select from the four options below to record the audio.

- Built-in Microphone
- Microphone connected to [AUX] terminal
- Microphone connected to [INPUT1] terminal
- Microphone connected to [INPUT2] terminal

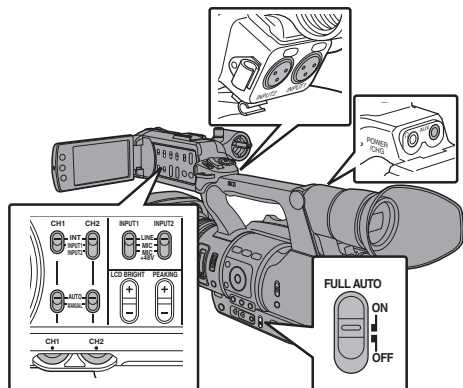

## Selecting Audio to Be Recorded in Each Channel

Select the audio to be recorded in CH1/CH2.

-	Switch Setting	Connected Devices
CH1	INT	<ul style="list-style-type: none"> <li>• Built-in Microphone</li> <li>• Microphone connected to [AUX] terminal</li> </ul>
	INPUT1	Microphone connected to [INPUT1] terminal
CH2	INT	<ul style="list-style-type: none"> <li>• Built-in Microphone</li> <li>• Microphone connected to [AUX] terminal</li> </ul>
	INPUT1	Microphone connected to [INPUT1] terminal
	INPUT2	Microphone connected to [INPUT2] terminal

Memo :

- When “INT” is set, the built-in microphone is disabled if a microphone is connected to the [AUX] terminal; audio from the microphone connected to the [AUX] is recorded.
- When “INT” is selected, set the reference input level in [Main Menu] → [A/V Set] → [Audio Set] → [Int. Mic Gain]/[AUX Gain].  
(☞ P108 [ Int. Mic Gain ] )  
(☞ P108 [ AUX Gain ] )

## Setting Input Channel to [INPUT1]/[INPUT2]

Select the audio to input to [INPUT1] and [INPUT2] terminals with the [INPUT1]/[INPUT2] mode switch.

Setting	Description
[LINE]	Use this setting when connecting to an audio device or other equipment. The reference input level is +4 dBu.
[MIC]	Use this setting when connecting to a dynamic microphone.
[MIC+48]	Use this setting when connecting to a microphone (phantom microphone) that requires a +48 V power supply.

Memo :

- When “MIC” or “MIC+48V” is selected, set the reference input level in [Main Menu] → [A/V Set] → [Audio Set] → [Input1 Mic Ref.]/[Input2 Mic Ref.].  
(☞ P107 [ Input1 Mic Ref. ] )  
(☞ P108 [ Input2 Mic Ref. ] )

Caution :

- When connecting a device that does not require a +48 V power supply, make sure that it is not set to the “MIC+48V” position.
- When the [INPUT1]/[INPUT2] mode switch is set to “MIC”, make sure that a microphone is connected to the [INPUT1]/[INPUT2] terminal. If you increase the recording level when a microphone is not connected, noise from the input terminal may be recorded.
- When a microphone is not connected to the [INPUT1]/[INPUT2] terminal, set the [INPUT1]/[INPUT2] mode switch to “LINE” or adjust the volume with the [CH1]/[CH2] recording level adjustment knob.

## Adjusting Audio Recording Level

You can select to adjust the audio recording levels for the two channels (CH1/CH2) manually or automatically.

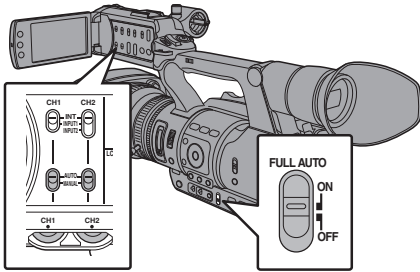

### Manual Adjustment Mode (Manual Adjustment)

- Set the [CH1/CH2 AUTO/MANUAL] switch on the camera recorder to "MANUAL" to enter the manual adjustment mode, and use the [CH1]/[CH2] recording level adjustment knob to set the recording level.
- You can adjust the level manually during the recording, recording standby, and stop modes.

#### ■ Setting Input Channel to "INPUT1"/"INPUT2"

- 1 Set the [CH1/CH2 AUTO/MANUAL] selection switch to "MANUAL" for the channel to be adjusted manually.
- 2 Turn the corresponding [CH1]/[CH2] recording level adjustment knob to adjust the level.

When [Audio Set] → [Limiter] is set to "Off", adjust such that the audio level meter does not light up at -2 dB even for loud sounds.  
(☞ P108 [Limiter])

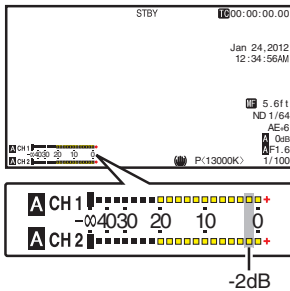

#### ■ Setting Input Channel to "INT" for Both [CH1] and [CH2]

- 1 Set the [CH1 AUTO/MANUAL] selection switch to "MANUAL".
- 2 Turn the [CH1] recording level adjustment knob to adjust the level.  
When the built-in microphone and the [AUX] input terminal are used, the recording levels of [CH1] and [CH2] are interlocked. This is also effective when the [CH1 AUTO/MANUAL] selection switch is set to [CH2].

Memo : \_\_\_\_\_

- Select [Limiter], [AGC Response], [AGC Mode], or [Int. Mic Separation] in the menu to set the recording audio.
- For the reference level to be recorded to an SD card, set [Main Menu] → [A/V Set] → [Audio Set] → [Ref. Level] to "-20dB", "-18dB", or "-12dB". (common for CH1/CH2)  
(☞ P108 [ Ref. Level ] )
- The operations of the [CH2] recording level adjustment knob and [CH2 AUTO/MANUAL] selection switch are disabled.

### Automatic Adjustment Mode

- Set the [CH1/CH2 AUTO/MANUAL] selection switch to "AUTO" or the [FULL AUTO] switch to "ON" to enter Automatic Adjustment mode. The audio recording level is set automatically according to the input level.
- When the [FULL AUTO] switch is set to "ON", mode switching with the [CH1/CH2 AUTO/MANUAL] selection switch is disabled.

Memo : \_\_\_\_\_

- When [Main Menu] → [A/V Set] → [Audio Set] → [Limiter] is set to "Off" while in the automatic adjustment mode, the limiter operates at -5 dBFS.  
If [Limiter] is set to other than "Off", the limiter operates according to the value set.  
(☞ P108 [Limiter])
- When [A/V Set] → [Audio Set] → [Audio On FULL AUTO] is set to "SW Set", you can switch the audio recording mode with the [CH1/CH2 AUTO/MANUAL] selection switch on the camera recorder even if the [FULL AUTO] switch is set to "ON".  
(☞ P109 [ Audio On FULL AUTO ] )

# Monitoring Audio Sound During Recording Using a Headphone

You can check the recorded audio using headphone.

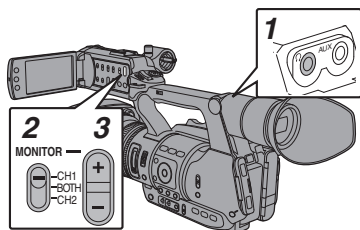

- 1 Connect the headphone.
- 2 Select the channel to monitor with the [MONITOR] selection switch.

Setting	Description
[CH1]	Outputs the audio recorded in [CH1].
[BOTH]	Outputs the audio recorded in [CH1/CH2].
[CH2]	Outputs the audio recorded in [CH2].

- 3 Use the [MONITOR +/-] button to adjust the monitor volume.

Memo : \_\_\_\_\_

- Audio during recording is not output from the monitor speaker.
- Warning tone is output when there is an abnormality in the camera recorder or when the battery is low.  
(☞ P162 [Warning Tone] )

## Selecting Audio Output Method When the [MONITOR] Selection Switch Is Set to "BOTH"

When a stereo type earphone jack is connected, perform the following setting to output stereo sound.

- 1 Set the [MONITOR] selection switch to "BOTH".
- 2 Set [Main Menu] → [A/V Set] → [Audio Set] → [Monitor] to "Stereo".  
(☞ P109 [ Monitor ] )

Memo : \_\_\_\_\_

- You can set the volume of the warning tone in [Main Menu] → [A/V Set] → [Audio Set] → [Alarm Level]. ("Off"/"Low"/"Middle"/"High")  
(☞ P109 [ Alarm Level ] )

# Time Code and User's Bit

Time code and user's bit data are recorded with the video in this camera recorder. The time code and user's bit are displayed on the viewfinder and LCD monitor during playback or recording. (Display screen)

## Displaying Time Code and User's Bit

The time code and user's bit are displayed on the viewfinder and LCD monitor during playback or recording. The display differs according to the menu settings.

- 1 Set [Main Menu] → [LCD/VF] → [Display Settings] → [TC/UB] to settings other than "Off".

(P106 [ TC/UB ] )

When "TC" or "UB" is selected, time code or user's bit data is displayed respectively on the display screen.

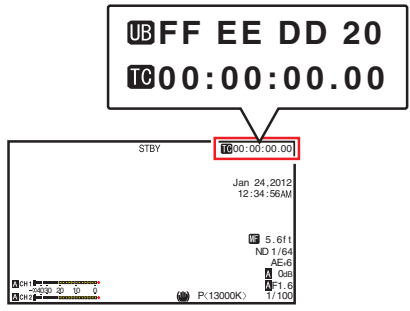

Memo : \_\_\_\_\_

- Values recorded on the SD card is displayed in Media mode.

# Time Code Operation Mode

Set the time code operation in [Main Menu] → [TC/UB] → [TC Generator].

(P102 [ TC Generator ] )

Setting	Description
Free Run(Ext)	This mode synchronizes another camera recorder connected to the [TC] terminal. The time code operates in the run mode at all times regardless of the recording status. It continues to run even when the power of the camera recorder is turned off.
Free Run	The time code operates in the run mode at all times regardless of the recording status. It continues to run even when the power of the camera recorder is turned off.
Rec Run	The time code operates in the run mode during recording. It continues to run in the order of the recorded clips as long as the SD card is not replaced. If the SD card is removed and recording is made on another card, time code will be recorded on the new card from where it was left off in the previous card.
Regen	The time code operates in the run mode during recording. When the SD card is replaced, the last time code recorded on the card is read and recorded on a new card so that the time code continues in running order. (P65 [Setting Time Code] )

Memo : \_\_\_\_\_

- When [Main Menu] → [System] → [Record Set] → [Rec Mode] is set to "Variable Frame", "Interval Rec" or "Frame Rec", and [TC Generator] is set to "Free Run" or "Free Run(Ext)", Rec Run is activated.
- When [Main Menu] → [System] → [Record Set] → [Record Format] → [A Format]/[B Format] is set to "AVCHD", Pre Rec enters Free Run mode. (P112 [ A Format ] ) (P113 [ B Format ] )

# Setting Time Code Generator

## Presetting the Time Code

Time code and user's bit data generated from the internal time code generator are recorded. This section describes how to set [TC/UB] → [TC Preset].

(☞ P103 [ TC Preset ] )

Memo : \_\_\_\_\_

- When [Main Menu] → [System] → [Record Set] → [Record Format] → [Frame & Bit Rate] is set to “50i(UHQ)”, “50i(HQ)”, “50i(SP)”, “50p(HQ)”, “50p(SP)”, “25p(HQ)”, “24p(UHQ)”, “24p(HQ)” or “50i”, settings cannot be made in “Drop”.

(☞ P112 [ A Frame & Bit Rate ] )

- You can configure the setting without accessing the [TC/UB] menu screen.

(☞ P67 [Setting Time Code without Opening the Menu] )

## Required Settings Before Preset

### 1 Set [TC/UB] → [TC Generator] to “Rec Run” or “Free Run”.

(☞ P102 [ TC Generator ] )

- [Rec Run]:  
Preset data in the time code generator operates in run mode during recording mode. Set this when recording continuous time code in connecting frames.
- [Free Run]:  
Time code starts to operate in run mode from the preset time in the time code generator.

### 2 Select the framing mode for the time code generator (only when the frame rate setting is “60” or “30”).

Set using [Main Menu] → [TC/UB] → [Drop Frame].

(☞ P103 [ Drop Frame ] )

- [Drop]:  
Sets the run mode of the time code generator to drop frame mode. Use this setting when placing emphasis on the recording time.
- [Non Drop]:  
Sets the run mode of the time code generator to non-drop frame mode. Use this setting when placing emphasis on the number of frames.

Memo : \_\_\_\_\_

Drop frame/non-drop frame mode

- When the frame rate setting in [Main Menu] → [System] → [Record Set] → [Record Format] → [Frame & Bit Rate] is “60p”, “60i”, or “30p”, the actual number of frames per second is approximately 59.94 (29.97). However, the time code processing standard is “60p”, “60i”, or “30p” frames. To make up for the frame number discrepancy, the drop frame mode (Drop) drops the 00 frame and 01 frame every minute except for minutes that are multiples of 10. However, in the case of “60p”, the 00, 01, 02 and 03 frame are dropped.
- The non-drop frame mode (Non Drop) does not drop frames and ignores the discrepancy with the actual time.

## Setting Time Code

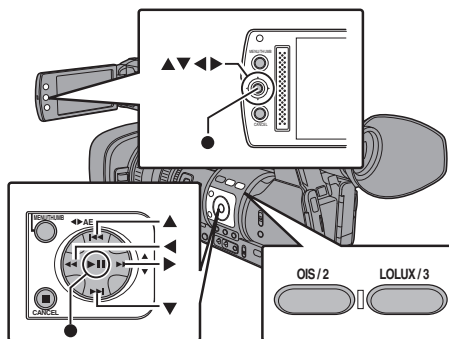

### 1 Select [Main Menu] → [TC/UB] → [TC Preset] and press the Set button (●).

(☞ P103 [ TC Preset ] )

The [TC Preset] screen appears.

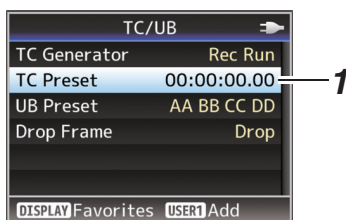

Memo : \_\_\_\_\_

- When [TC/UB] → [TC Generator] is set to “Regen”, the parameter is displayed as “Regen” and cannot be selected.  
(☞ P102 [ TC Generator ] )

- 2 Set the time code (hour, minute, second, frame).**  
 Use the cross-shaped button (◀▶) to place the cursor at the item to set, then use the cross-shaped button (▲▼) to change the values.

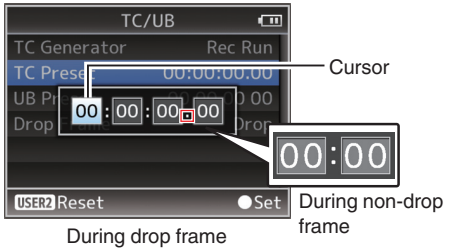

- Memo : \_\_\_\_\_
- Press the [OIS/2] button to reset each digit to "0". The cursor moves to the time digit (left).

- 3 Check the values and press the Set button (●).**
- The time code is set and the screen returns to [TC/UB].
  - To cancel the setting, press the [CANCEL] button.
- 4 Press the [MENU] button.**  
 Returns to the normal screen.

**Presetting the User's Bit**

You can add an 8-digit hexadecimal number as the user's bit to the recorded image.

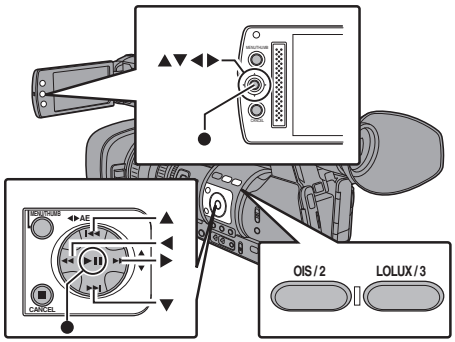

- 1 Select [Main Menu] → [TC/UB] → [UB Preset] and press the Set button (●).**  
 (☞ P103 [ UB Preset ] )  
 The [UB Preset] setting screen appears.

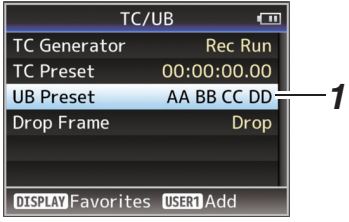

- Memo : \_\_\_\_\_
- When [TC/UB] → [TC Generator] is set to "Regen", the parameter is displayed as "Regen" and cannot be selected. (☞ P102 [ TC Generator ] )

- 2 Use the cross-shaped button (◀▶) to place the cursor at the item to set, then use the cross-shaped button (▲▼) to change the values.**  
 Numbers between 0 and 9 or alphabets between A and F can be specified for the user's bit.

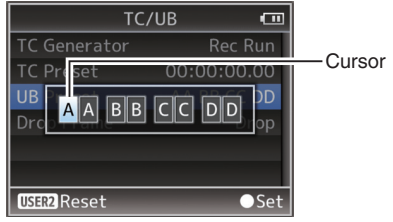

- Memo : \_\_\_\_\_
- Press the [OIS/2] button to reset each digit to "0". The cursor moves to the left.

- 3 Check the values and press the Set button (●).**
- The time code is set and the screen returns to [TC/UB].
  - To cancel the setting, press the [CANCEL] button.
- 4 Press the [MENU] button.**  
 Returns to the normal screen.

## Setting Time Code without Opening the Menu

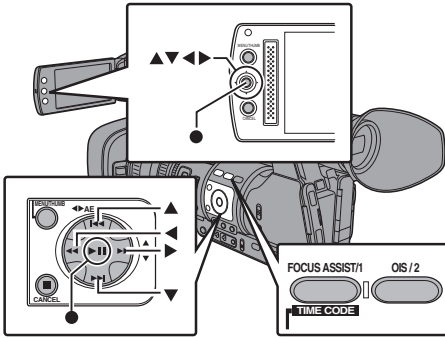

Memo : \_\_\_\_\_

- Settings cannot be made in the following cases.
  - [TC/UB] → [TC Generator] has been set to “Regen”.
  - Menu screen is displayed.
  - The camera recorder is not in the Camera mode.

### Setting Time Code

- 1 Set [TC/UB] → [TC Generator] to settings other than “Regen”.  
(☞ P102 [ TC Generator ] )
- 2 Hold down the [MENU] button and press the [FOCUS ASSIST/1] button.  
The [TC Preset] setting screen appears.

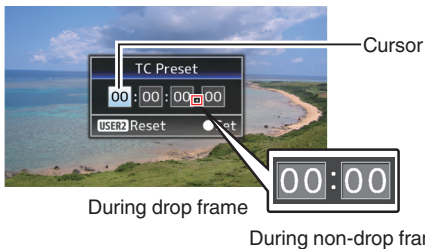

- 3 Set the time code (hour, minute, second, frame).  
Use the cross-shaped button (◀▶) to place the cursor at the item to set, then use the cross-shaped button (▲▼) to change the values.

Memo : \_\_\_\_\_

- Press the [OIS/2] button to reset each digit to “0”.  
The cursor moves to the time digit (left).

- 4 Check the values and press the Set button (●).
  - The time code is set and the screen returns to the normal screen.
  - To cancel the setting, press the [CANCEL] button.

Caution : \_\_\_\_\_

- When the camera recorder is switched to Media mode during editing, editing will be canceled and the screen will close.
- When editing the time code, operation of the [FOCUS ASSIST/1] and [OIS/2] buttons that are configured in [Main Menu] → [Camera Function] → [User Switch Set] is disabled. The [OIS/2] button functions as the number reset button.  
(☞ P97 [ User Switch Set Item ] )

### Recording Time Code in Continuation of the Recorded Time Code on SD Card

This camera recorder is equipped with the time code reader.

- 1 Set [TC/UB] → [TC Generator] to “Regen”.
  - When the camera recorder enters from recording standby mode to recording mode, it reads the time code already recorded on the SD card and records the new time code in continuation of that value.
  - The same data as the user’s bit already recorded on the SD card is recorded.

Memo : \_\_\_\_\_

- When [TC/UB] → [TC Generator] is set to “Regen”, the framing mode of the time code follows the settings in [TC/UB] → [Drop Frame] instead of the clip settings.  
(☞ P103 [ Drop Frame ] )



# Synchronizing Time Code on Another Camera

This camera recorder is equipped with a time code input/output terminal ([TC] terminal). Connect another camera recorder to the [TC] terminal and synchronize to the time code.

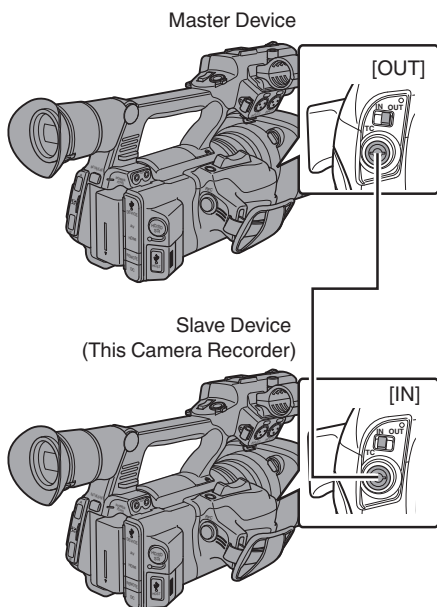
- 1 **Connect the [TC] terminal of the master device with the [TC] terminal of the slave device.**  
Set the [TC IN/OUT] switch of the master device to "OUT", and the [TC IN/OUT] switch of the slave device to "IN".



## Settings and Operation of the Camera Recorder

- 1 **Set to Camera mode.**  
(☞ P18 [Operation Modes] )
- 2 **Set [TC/UB] → [TC Generator] as follows.**
  - Slave device:  
Select "Free Run(Ext)".
  - Master device:  
Select "Free Run".
- 3 **Set LCD monitor or viewfinder to Display 1 screen.**
- 4 **Set the master device and run the time code.**
  - When the built-in time code generator is synchronized with the external time code data input, the  icon on Display 1 screen lights up.
  - When time code is not synchronized or time code input is not available, the  icon goes out.

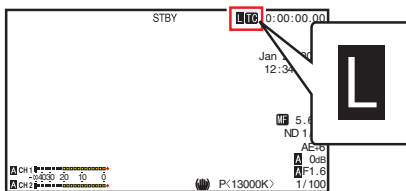

Memo : \_\_\_\_\_

- The built-in time code generator will continue operation even when the master device is disconnected after synchronization.
- User's bit will become data in the master device.
- While the [TC] terminal is connected, the time code may be out of synchronization when the [A/V Set] → [Video Set] → [HDMI/SDI Out] setting of the Master device and Slave device is being changed.  
(☞ P107 [ HDMI/SDI Out ] )

# Setting Zebra Pattern

When the luminance level range for displaying zebra patterns is specified, diagonal lines (zebra pattern) are displayed at areas with the specified luminance levels during shooting.

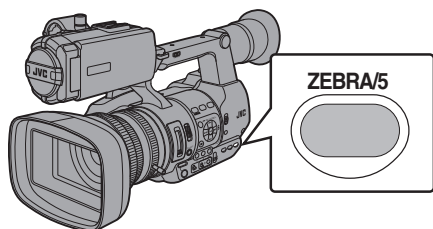

- 1 **Set the zebra display pattern.**  
Select the display pattern in [LCD/VF] → [Shooting Assist] → [Zebra].
- 2 **Specify the brightness (luminance) level range for displaying zebra pattern.**  
Specify the upper and lower limits of the luminance level in [LCD/VF] → [Shooting Assist] → [Zebra] → [Top] and [Bottom].

Item	Settings	Options
Top	Upper luminance limit for displaying [Zebra]	5% - 100%, Over (in 5 % increments)
Bottom	Lower luminance limit for displaying [Zebra]	0% - 100% (in 5 % increments)

- 3 **Display the zebra pattern.**  
Press the [ZEBRA/5] button to display the zebra pattern in the specified range.



Memo : \_\_\_\_\_

- “Zebra” is assigned to [ZEBRA/5] button in factory default.
- “Zebra” can also be assigned to other user buttons.  
(P38 [Assigning Functions to User Buttons] )

# Setting Spot Meter

The brightness of the object during shooting is displayed.

This function is useful when setting video or stage lighting or when specifying camera exposure.

A cursor indicating the location and the brightness (%) of that location are displayed in the images shown on the LCD monitor and viewfinder screen.

- Zebra patterns display the brightness of output video signals.

( P69 [Setting Zebra Pattern] )

- This function allows you to check the brightness of input images from the lens without depending on image processing such as gamma curve. The dynamic range of the camera recorder is 400 % and a brightness range of 0 % to 400 % and above is displayed.

Memo : \_\_\_\_\_

- Spot meter may not be consistent with the zebra display range. When [Camera Process] → [Gamma] is set to “Cinema”, the 100IRE output is not consistent with the 100 % display. When an object of more than 400 % luminance is detected, it is displayed as “400 %”.

( P99 [ Gamma ] )

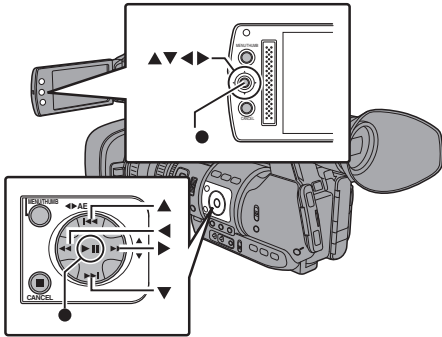

- 1 Select one of the following from [Main Menu] → [Camera Function] → [User Switch Set] → [Spot Meter].

( P97 [ Spot Meter ] )

Item	Settings	Color of Frame Indicating the Position
Max & Min	Displays the brightness (%) and positions of the brightest and darkest areas in the screen. Frames may also be stopped at the current positions.	<ul style="list-style-type: none"> <li>• Max: Green</li> <li>• Min: Yellow</li> </ul>
Max	Displays the brightness (%) and position of the brightest area in the screen. Frames may also be stopped at the current positions.	Green
Min	Displays the brightness (%) and position of the darkest area in the screen. Frame may also be stopped at the current positions.	Yellow
Manual	Displays the brightness (%) of the specified position.	Green (Blinks in green when specifying the position)

- 2 Assign the “Spot Meter” function to any of the user buttons.

( P38 [Assigning Functions to User Buttons] )

- 3 Press the user button that is assigned with “Spot Meter”.

The operation switches as below when the button is pressed.

## When [Max & Min]/[Max]/[Min] is selected

- ① The cursors appear according to the setting when the button is pressed. Green and yellow frames appear, and the brightness levels of these areas are displayed.

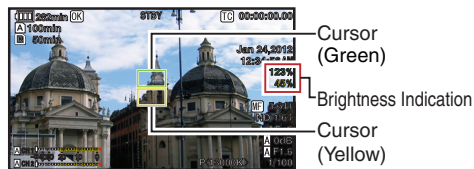

- ② Hold down the button in the state in ①, the positions of the brightest (Max) and darkest (Min) areas in the screen are automatically detected with regard to the changes of the object, and the brightness level of these areas are displayed.

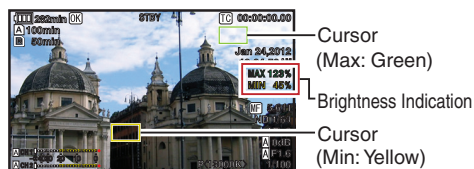

- ③ Pressing the button in the state in ② stops the automatic position detection. The frames are fixed at the stopped positions and the brightness levels are displayed.

- ④ By pressing the button, the cursors and brightness indication disappear.



## When [Manual] is selected

- ① The brightness of the cursor position is displayed when the button is pressed.

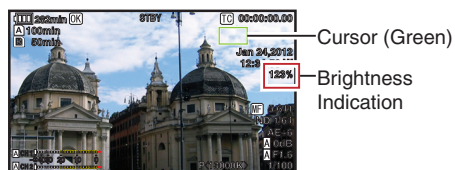

- ② By pressing the button, the cursors and brightness indication disappear.

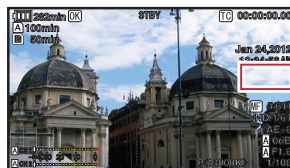

- ③ Hold down the button in the state in ① or ②, the cursor blinks in green. Move the cursor with the cross-shaped button (▲▼◀▶) to specify the position to display the brightness. When you decide on the position, press the Set button (●) to confirm.

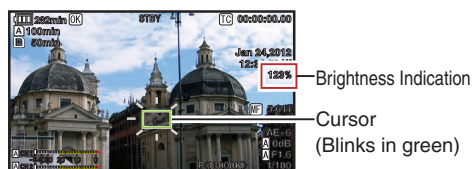

- ④ Frames are fixed at the stopped positions and the brightness is displayed.

Memo : \_\_\_\_\_

- When moving the cursor position, [Shutter]/[AE Level] control is disabled.
- When the brightness is 0 % in the entire screen, the frame is fixed in the center.
- If the cursor is outside the “4:3” range, changing [Main Menu] ⇒ [System] ⇒ [Record Set] ⇒ [Record Format] ⇒ [SD Aspect] from “16:9” to “4:3” restores the cursor to the default position. (P113 [SD Aspect] )

# Acquiring Positioning Information by GPS

This camera recorder comes with a built-in GPS function. The GPS function is able to record the positioning information. During playback, you can also display the recorded information on the playback screen.  
( P87 [Playing back])

## 1 Set [Main Menu] → [System] → [GPS] to “On”.

- Positioning starts when the icon on the display screen starts blinking.
- After positioning is complete, the icon switches to a solid light and records the positioning information during shooting.
- The icon that appears on the screen changes according to the condition of signal reception from the GPS satellite.
- The GPS function is able to record the positioning information. However, the date/time information (atomic clock) can be recorded only when [Format] is set to “AVCHD” on the slot to record to.

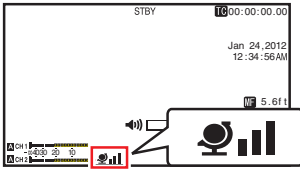

Display	Reception Status	Positioning Status
(Yellow)	[GPS] is set to “On”, but signal cannot be received	GPS signal cannot be received. UTC and positioning information cannot be obtained.
(Blink)	GPS search in progress	UTC information can be obtained, but not positioning information.
(Weak)	GPS reception in progress (signal strength: weak)	Receiving weak GPS signal. UTC and positioning information can be obtained and recorded.
(Medium)	GPS reception in progress (signal strength: medium)	Receiving GPS signal. UTC and positioning information can be obtained and recorded.

Display	Reception Status	Positioning Status
(Strong)	GPS reception in progress (signal strength: strong)	Receiving strong GPS signal. UTC and positioning information can be obtained and recorded.
(No display)	GPS function is turned off	The [GPS] item is set to “Off”.

Memo :

- If positioning cannot be performed after waiting for several minutes, this means GPS reception is poor, and there is difficulty in receiving data. Move to an open place with no obstructions. Otherwise, GPS information will not be recorded when shooting is performed.
- Signal may not be received depending on circumstances such as locations that are indoors or surrounded by tall buildings, or the geographical conditions. Precision error may occur in the position information depending on the conditions of reception.
- Even when positioning is in progress, information may be disrupted depending on the condition of signal reception.

## Viewing Recorded Videos Immediately (Clip Review)

You can check (review) the last recorded video clip on the screen.

However, the video clip cannot be played back if the settings of the camera recorder are different from the video format (Resolution/Frame & Bit Rate/SD Aspect) of the clip.

- ( P112 [ **A** Resolution ] )
- ( P113 [ **B** Resolution ] )
- ( P112 [ **A** Frame & Bit Rate ] )
- ( P113 [ **B** Frame & Bit Rate ] )
- ( P113 [ SD Aspect ] )

Memo :

- To use this function, assign “Clip Review” to any of the user buttons. “Clip Review” is assigned to [C.REVIEW/7] button in factory default.
- “Clip Review” can also be assigned to other user buttons.  
( P38 [Assigning Functions to User Buttons] )

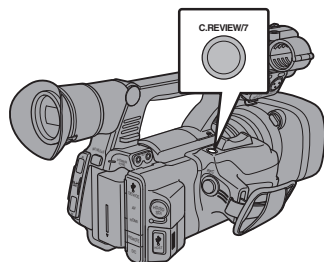

## Recording Simultaneously at Two Different Definitions

By setting [System] to “HD+SD” or “HD+Web”, you can record simultaneously at two different definitions.

- When HD+SD is selected:  
Records a high-definition (HD) file to slot A and a standard definition (SD) file to slot B at the same time.
- When HD+Web is selected:  
Records a high-definition (HD) file to slot A and a low bit-rate web file to slot B at the same time. Web files can be used as a proxy file for the HD file.

### 1 Press the button assigned with the “Clip Review” function during standby (“STBY” is displayed).

Playback of the configured section starts.

Memo : \_\_\_\_\_

- The video clip is played back according to the setting in [Main Menu] → [Camera Function] → [User Switch Set] → [Clip Review]. By default setting (Last 5sec), the last 5 seconds of the clip is played back.  
(☞ P97 [Clip Review] )
- When playback is complete, the camera recorder exits Clip Review and returns to “STBY” (recording standby) mode.

Caution : \_\_\_\_\_

- During Clip Review, only the [CANCEL] and [REC] buttons are enabled.  
Press the [CANCEL] button to cancel clip review and return to “STBY” (recording standby) mode. Press the [REC] button to cancel clip review and enter recording mode. It will take some time to start recording after the button is pressed.
- When the last clip is less than 5 seconds, the whole clip is played back.
- Only video clips in the currently selected slot can be reviewed.
- When there are no clips in the selected slot, Clip Review function is disabled.
- Clip Review is unavailable when Clip Continuous Rec is paused (“STBY<sup>C</sup>”, yellow text). To operate Clip Review, use the [CANCEL] button to set to “STBY<sup>C</sup>” (white text) first.  
(☞ P78 [Clip Continuous Rec] )
- Clip Review is unavailable when the camera recorder is connected to an external equipment and the equipment is in recording state.
- Clip Review is unavailable when operating View Remote via network connection.  
(☞ P150 [View Remote Feature] )

Memo : \_\_\_\_\_

- If a recordable SD card is inserted into only one of the slots, files will only be recorded to that slot.
- The [Rec Mode] is fixed at “Normal”.
- Clip Cutter Trig is disabled.
- [Slot Mode] cannot be selected.
- Clip Review can only be performed for slot A. (“No Media” appears if there is no card in slot A while a card is inserted into slot B.)
- Playback of web files is only possible from slot B when “HD+Web” is selected.

## Splitting the Clips Freely (Clip Cutter Trig)

You can split the clips freely without having to stop recording during shooting.

- 1 Assign the “Clip Cutter Trig” function to any of the user buttons.  
(☞ P38 [Assigning Functions to User Buttons])
- 2 Press the user button that is assigned with “Clip Cutter Trig” during shooting.  
[CLIP CUT] appears on the display screen and the clip is split.

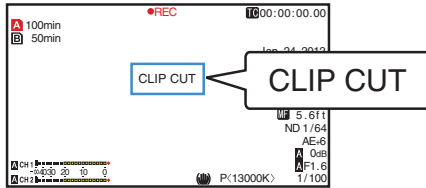

Memo : \_\_\_\_\_

- Clips cannot be split again for a few seconds after the operation is performed.
  - This item cannot be used when [Slot Mode] is set to “Backup”.
  - Available only when [System] is set to “HD” or “SD”.
- (☞ P76 [Backup Rec])
- This item cannot be used when [Rec Mode] is set to a value other than “Normal” or “Pre Rec”.
- (☞ P113 [Rec Mode])
- The split clips are recorded seamlessly without interruptions in the video.

## Dual Rec

- If both the slots are loaded with recordable cards in the factory default ([Slot Mode] is set to “Series”), pressing the [REC] button starts recording only to the media in the selected slot. When the remaining space in the selected media runs out, recording continues by automatically activating the media in the other slot.
- If both the slots are loaded with recordable cards in the Dual Rec mode ([Slot Mode] is set to “Dual”), pressing the [REC] button starts recording simultaneously to the media in both the slots.
- The clips recorded to the media in both the slots are identical, and two clips of the same content can be created only on this camera recorder.  
(☞ P114 [Slot Mode])

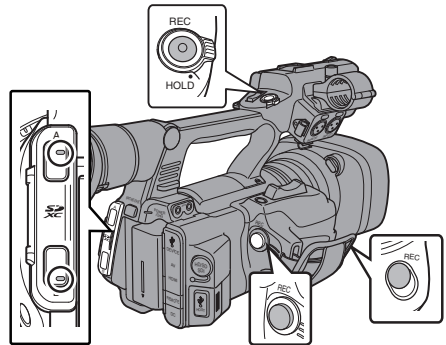

### Setting to Dual Rec Mode

- 1 Set [Main Menu] → [System] → [Record Set] → [Slot Mode] to “Dual”.  
(☞ P114 [Slot Mode])  
“DUAL” appears on the display screen.

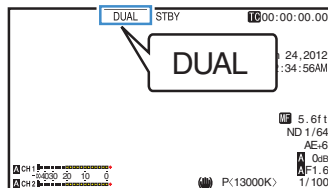

## 2 Start recording.

- Insert recordable media in both slots, and press the [REC] button.
- In the Dual Rec mode, recording to the media in both slots starts at the same time.
- Both the card slot marks turn red, and the status indicators of both the card slots also light up in red.

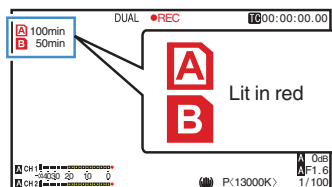

## 3 Stop recording.

- Press the [REC] button again.
- Recording to both slots stops, and both the card slot marks turn white.
- The same clips are recorded to both cards.

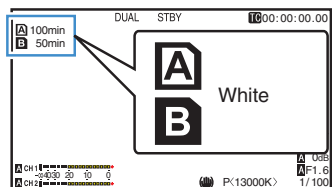

### Memo :

- During recording in the Dual Rec mode, both the card slot marks light up in red.
- During recording in the Dual Rec mode to two cards with a different amount of remaining space, if the space of one card runs out, recording to both slots will stop automatically. After recording stops, recording automatically resumes for the card with remaining space. Although the clips are separated in this case, the clips can be seamlessly joined by arranging them on the timeline of the editing software since they are recorded seamlessly.
- If the last clip on the cards that are inserted in the two slots are different from each other, and the time code operating mode is set to "Regen", the Regen mode for the selected card slot will be enabled in the next recording.

### Caution :

- To perform recording in the Dual Rec mode, it is recommended that you start recording by making use of two cards with the same capacity and from the formatted state.
- You can combine the use of the Dual Rec mode with a special recording mode. While in the Dual Rec mode, you can also set [Rec Mode] to "Normal", "Pre Rec", "Clip Continuous", "Interval Rec", "Frame Rec", or "Variable Frame". When [Main Menu] → [System] → [Record Set] → [Record Format] → [A]Format is set to "AVCHD", "Clip Continuous" cannot be selected.  
(P78 [Special Recording])  
(P113 [Rec Mode])  
(P112 [A]Format)
- When both slots are inserted with recordable cards, the Dual Rec (simultaneous recording) operation can be performed. If a recordable media is only inserted in one of the slots, you can also start recording with one card.
- In the Dual Rec mode, continuous recording by switching from one slot to another cannot be performed. Continuous recording will not be performed if a recordable media is inserted in a slot after recording to the other slot has started.
- When recording to one slot is in progress with the recorder set to the Dual Rec mode, inserting a recordable media to the other slot does not enable the Dual Rec operation. To perform the Dual Rec operation, stop recording temporarily (excluding pausing recording in the Clip Continuous Rec mode), and start again.
- When one of the cards is accidentally removed while recording is in progress in the Dual Rec mode, recording to the card in the other slot will continue. However, repair of the accidentally removed card by the recovery function may fail.
- If an error occurs on one of the cards while recording is in progress in the Dual Rec mode, recording of the erroneous card stops, while that of the other card continues.
- Operations on clips recorded in the Dual Rec mode, such as clip deletion in the Media mode or appending of OK marks, can only be performed on the card in the selected slot.

# Backup Rec

- The Backup Rec mode allows you to make use of the media in slot B for backup recording by controlling the starting and stopping of recording in slot B without using the [REC] button.
- Start or stop the recording using [Main Menu] → [System] → [Record Set] → [Slot Mode] → [Backup Rec] or press the user button that is assigned with “Backup Trig”.  
(☞ P114 [ Slot Mode ])  
(☞ P97 [User Switch Set Item ])

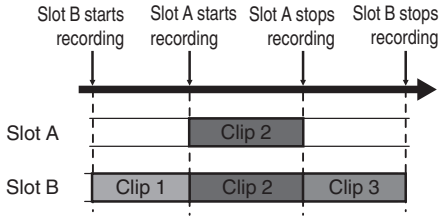

Memo : \_\_\_\_\_

- During the Backup Rec mode (when [Slot Mode] is set to “Backup”), you can control recording to the 2 slots at different timings, and backup recording can only be performed on this camera recorder.  
(☞ P114 [ Slot Mode ])
- You can record without worrying about missing the important scenes by setting slot B to be always recording (backup recording) and using the [REC] button to start/stop recording of only the required scenes in slot A.
- It is recommended to use a media with high capacity in slot B.
- When [Main Menu] → [System] → [Record Set] → [Record Format] → [A Format] is set to “AVCHD”, backup recording cannot be performed.  
(☞ P112 [ A Format ])

- 1 Set [Main Menu] → [System] → [Record Set] → [Slot Mode] to “Backup”.  
(☞ P114 [ Slot Mode ])  
“BACKUP” appears on the display screen.

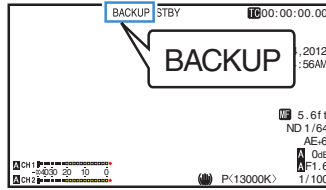

- 2 Start backup recording. (Backup recording into slot B)

- Select “REC” in [Main Menu] → [System] → [Record Set] → [Slot Mode] → [Backup Rec] and press the Set button (●).
- (☞ P114 [ Slot Mode ])
- You can also press the user button that is assigned with “Backup Trig”.  
(☞ P97 [User Switch Set Item ])
- Backup recording into slot B starts. (The characters “BACKUP” appear in red.)
- The card slot mark of slot B turns red (selected state), and the status indicator of slot B also blinks in red.

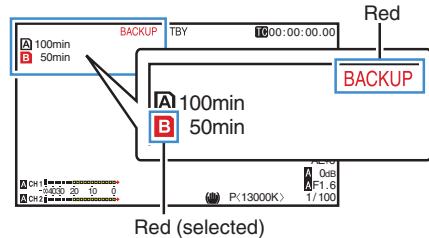

**3 Start normal recording (normal recording into slot A)**

- Press any of the [REC] buttons.
- Recording into the media in slot A starts. (The characters “●REC” appear in red.)
- The card icon of slot A turns red (unselected state), and the status indicator of slot A blinks in red.

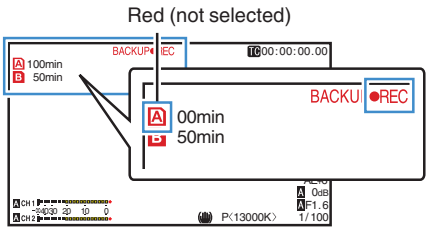

**4 Stop normal recording.**

- Press any of the [REC] buttons again.
- Recording to slot A stops, and the card slot mark of slot A turns white (unselected state).
- The characters “●REC” (red) changes back to “STBY” (white).
- The status indicator of slot A goes out.

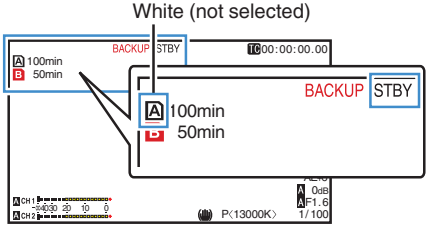

**5 Stop backup recording.**

- Select [STBY] in [Main Menu] → [System] → [Record Set] → [Slot Mode] → [Backup Rec] and press the Set button (●).

(☞ P114 [ Slot Mode ] )

- You can also press the user button that is assigned with “Backup Trig”.

(☞ P97 [User Switch Set Item] )

- Recording to slot B stops, and the card slot mark of slot B turns white (unselected state).
- The characters “BACKUP” changes back to white.
- The status indicator of slot B lights up in green.

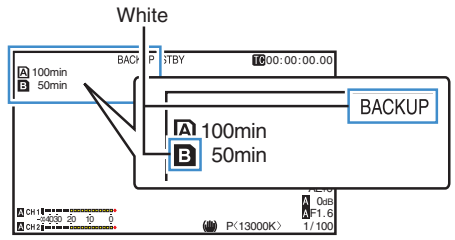

Memo : \_\_\_\_\_

- During backup recording, if the space of one card runs out, recording stops only for the card that is full.
- When recording to both slots is stopped, recording in the Regen mode will be enabled for the card slot in which recording started.
- When recording is started in the other slot while recording to one slot, the clip being recorded is split and simultaneous recording to the other card starts.
- When recording is stopped for either slot A or B while recording to both slots, the clip on the slot which is still recording is split.
- Although the clips are separated during recording the clips can be seamlessly joined by arranging them on the timeline of the editing software since they are recorded seamlessly.
- Clip Cutter Trig cannot be performed during backup recording.  
(☞ P74 [Splitting the Clips Freely (Clip Cutter Trig)] )
- When [Slot Mode] is set to “Backup”, [Rec Mode] can only be set to “Normal”.  
(☞ P113 [ Rec Mode ] )

# Special Recording

Besides the normal recording mode, five special recording methods are available in this camera recorder. They are Pre Rec, Clip Continuous, Frame Rec, Interval Rec and Variable Frame. Select a mode from [Record Set] → [Rec Mode].

Memo : \_\_\_\_\_

- Set using [Main Menu] → [System] → [Record Set] → [Rec Mode].  
(☞ P113 [ Rec Mode ] )
- When [Main Menu] → [System] → [Record Set] → [Record Format] → [A Format] is set to “AVCHD”, “Clip Continuous” cannot be selected.  
(☞ P112 [ A Format ] )

## Pre Rec

- By setting the number of seconds in the [Pre Rec Time], you can start recording video and audio before actual recording starts based on the [Pre Rec Time] setting.
- When starting actual recording while the camera recorder is in Recording Standby (STBY $\square$ ) mode, you can start recording a few seconds earlier based on the [Pre Rec Time] setting.
- Using Pre Rec allows you to record a complete event without missing the initial scenes even if you start the recording late.

Memo : \_\_\_\_\_

- Pre Rec Time can be set to “5sec”, “10sec”, or “15sec” in [Main Menu] → [System] → [Record Set] → [Rec Mode] → [Pre Rec Time].  
(☞ P114 [ Pre Rec Time ] )

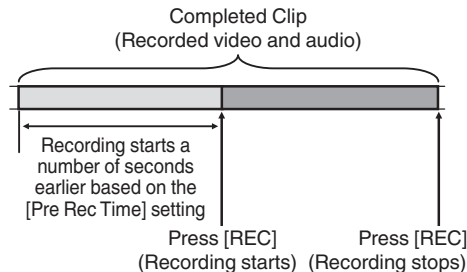

## 1 Set [Rec Mode] to “Pre Rec”.

(☞ P113 [ Rec Mode ] )

- Set [Main Menu] → [System] → [Record Set] → [Rec Mode] to “Pre Rec”.
- The display changes (“STBY” → “STBY $\square$ ”).

## 2 Press the [REC] button to start recording in Pre Rec mode.

- The display changes (“STBY $\square$ ” → “●REC $\square$ ”) and the card slot status indicator lights up in red.
- Press the [REC] button again to pause recording. The display changes (“●REC $\square$ ” → “STBY $\square$ ”) and the card slot status indicator lights up in green.

Caution : \_\_\_\_\_

- When the interval between start and stop recording is short, “STBY $\square$ ” may not be displayed immediately after recording is complete.  
“●REC $\square$ ” → “STBY $\square$ ” (“STBY” blinks in red) → “STBY $\square$ ” is displayed.
- When the SD card becomes full during recording, recording stops and “STOP” is displayed.
- Video and audio before the above mentioned time may not be recorded after recording starts in the following cases.
  - Immediately after power on
  - Immediately after recording stops
  - Immediately after switching from Media mode to Camera mode
  - Immediately after setting [Rec Mode]
  - Immediately after the end of Clip Review
  - Immediately after changing file format
  - Immediately after changing video format

## Clip Continuous Rec

- In normal recording, when the recording stops, the image, audio, and accompanying data from the start till the end of the recording are recorded as one “clip” on the SD card.
- This mode allows you to consolidate several rounds of “startstop recording” into one clip.

Example:

In normal recording, three clips are generated as Recording 1, Recording 2, and Recording 3. However, recording in this mode generates only one clip.

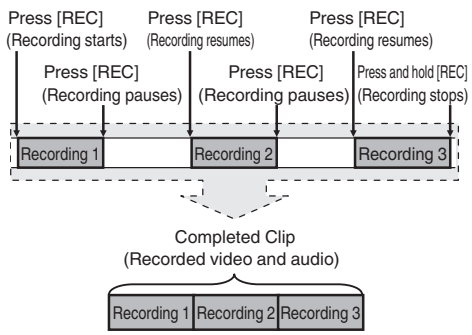

- 1 **Set “Rec Mode” to “Clip Continuous”.**  
(☞ P113 [ Rec Mode ] )
  - Set [Main Menu] → [System] → [Record Set] → [Rec Mode] to “Clip Continuous”.
  - The display changes (“STBY” → “STBY $\text{C}$ ”).

- 2 **Start recording. (Recording 1)**
  - Press the [REC] button to start recording in Clip Continuous mode.
  - The display changes (“STBY $\text{C}$ ” → “●REC $\text{C}$ ”) and the card slot status indicator lights up in red.

- 3 **Pause recording.**
  - Press the [REC] button again to pause recording. The display changes (“●REC $\text{C}$ ” → “STBY $\text{C}$ ” (yellow text)).
  - The card slot status indicator remains lighted in red.

Memo : \_\_\_\_\_

- When the [CANCEL] button is pressed while the camera recorder is paused (STBY $\text{C}$ ), the display changes (“STBY $\text{C}$ ” (yellow text) → “STBY $\text{C}$ ” (blinking yellow text) → “STBY $\text{C}$ ” (white text)), and a “clip” is generated. The card slot status indicator lights up in green.

- 4 **Resume recording. (Recording 2)**
  - Press the [REC] button again to resume recording. The display changes (“STBY $\text{C}$ ” (yellow text) → “●REC $\text{C}$ ”).
  - The card slot status indicator remains lighted in red.

- 5 **Pause recording.**
  - Press the [REC] button again to pause recording. The display changes (“●REC $\text{C}$ ” → “STBY $\text{C}$ ” (yellow text)).
  - The card slot status indicator remains lighted in red.

- 6 **Resume recording. (Recording 3)**
  - Press the [REC] button again to resume recording. The display changes (“STBY $\text{C}$ ” (yellow text) → “●REC $\text{C}$ ”).
  - The card slot status indicator remains lighted in red.

- 7 **Press and hold the [REC] button.**
  - Recording stops and the display changes (“●REC $\text{C}$ ” → “STBY $\text{C}$ ”). A “clip” is generated.
  - The card slot status indicator lights up in green.

- 8 **Press the [REC] button again.**
  - The display changes (“STBY $\text{C}$ ” → “●REC $\text{C}$ ”) and the card slot status indicator lights up in red.
  - A new “clip” is generated from here.

Memo : \_\_\_\_\_

- The following operations cannot be performed while recording is paused (STBY $\text{C}$ , yellow text).
  - Clip Review operation (☞ P72 [Viewing Recorded Videos Immediately (Clip Review)] )
  - Switching SD card slots
  - Switching operation mode (☞ P18 [Operation Modes] )
- Files are split into sizes of 4 GB (or 30 minutes) regardless of the menu settings.

Caution : \_\_\_\_\_

- Do not remove the SD card during recording (●REC $\text{C}$ , red text) or recording pause (STBY $\text{C}$ , yellow text).
- To remove the SD card in the “Clip Continuous” mode, press the [CANCEL] button, check that “STBY $\text{C}$ ” (white text) is displayed and the card slot status indicator lights up in green before you remove the card.
- When the SD card becomes full during recording, recording stops and “STOP” is displayed.
- When the [POWER ON/OFF(CHG)] switch is turned off during recording or recording pause, recording stops and power is cut off after a clip is generated.

Caution : \_\_\_\_\_

- If the power is cut off due to low battery power, a proper clip may not be generated.
- When [A Format]/[B Format] in the [Main Menu] → [System] → [Record Set] → [Record Format] menu is set to "AVCHD", Clip Continuous Rec cannot be performed.  
(☞ P112 [A Format])  
(☞ P113 [B Format])

## Frame Rec

In normal recording, when the recording stops, the image and accompanying data from the start till the end of the recording are recorded as one "clip" on the SD card.

In this mode, recording starts with every press of the [REC] button, and only the specified number of frames is recorded.

The recording can be written to the media as a single clip until it is stopped.

Memo : \_\_\_\_\_

- Audio will not be recorded.
- Until a specified amount of recordings is accumulated, the file cannot be written to the media.
- If the specified amount is not reached when recording is stopped, normal recording is performed and frames are added to the ending of the clip until the amount is reached. (Padding)
- After the specified number of frames is recorded and written to the media, recording will be performed until the same number is accumulated again.

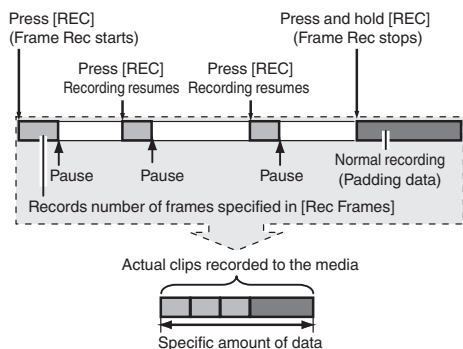

### 1 Set [Rec Mode] to "Frame Rec".

- Set [Main Menu] → [System] → [Record Set] → [Rec Mode] to "Frame Rec".  
(☞ P113 [Rec Mode])
- The display changes ("STBY" → "STBY").

### 2 Set the number of frames to record in [Rec Frames].

- Set using [Main Menu] → [System] → [Record Set] → [Rec Mode] → [Rec Frames].  
(☞ P114 [Rec Frames])

### 3 Start recording.

- Press the [REC] button to record only the number of frames specified in [Rec Frames] and pause.
- The display changes ("STBY" → "●REC" → "STBY") (yellow text).
- The card slot status indicator lights up in green.

### 4 Repeat Frame Rec.

- Press the [REC] button again to record only the number of frames specified in [Rec Frames] and pause.
- The display changes ("STBY" → "●REC" → "STBY") (yellow text).
- Frame Rec continues until the recording is stopped (step 5).

### 5 Press and hold the [REC] button.

- The card slot status indicator lights up in green.

Caution : \_\_\_\_\_

- Do not remove the SD card during recording ("●REC", red text) or recording pause ("STBY", yellow text).
- To remove the SD card during Frame Rec, press the [CANCEL] button, check that "STBY" (white text) is displayed and the card slot status indicator lights up in green before you remove the card.
- When [Main Menu] → [TC/UB] → [TC Generator] is set to "Free Run" or "Free Run(Ext)", the time code will be recorded in "Rec Run".
- Audio cannot be recorded. A ⊙ mark appears in the audio level meter display.  
(☞ P122 [Audio Level Meter])

## Interval Rec

In normal recording, when the recording stops, the image and accompanying data from the start till the end of the recording are recorded as one “clip” on the SD card.

In this mode, recording and pause are performed repeatedly at the specified time interval. Only the specified number of frames is recorded. The recording can be written to the media as a single clip until it is stopped.

Memo : \_\_\_\_\_

- Audio will not be recorded.
- Until a specified amount of recordings is accumulated, the file will not be written to the media.
- After the specified number of frames is recorded and written to the media, recording will be performed until the same number is accumulated again.
- If the specified amount is not reached when recording is stopped, normal recording is performed and frames are added to the ending of the clip until the amount is reached. (Padding)

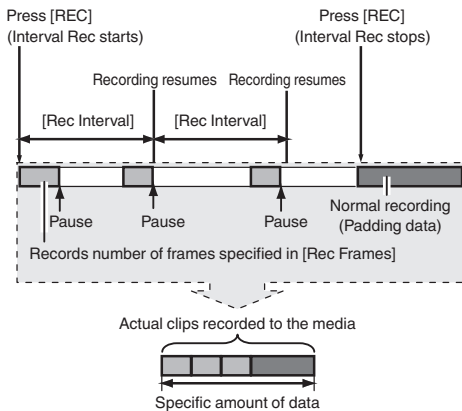

### 1 Set [Rec Mode] to “Interval Rec”.

- Set [Main Menu] → [System] → [Record Set] → [Rec Mode] to “Interval Rec”.  
(☞ P114 [ Rec Interval ] )
- The display changes (“STBY” → “STBY”).

### 2 Set the number of frames to record in [Rec Frames].

- Set using [Main Menu] → [System] → [Record Set] → [Rec Mode] → [Rec Frames].  
(☞ P114 [ Rec Frames ] )

### 3 Set the time interval to start recording in [Interval Rec].

- Set using [Main Menu] → [System] → [Record Set] → [Rec Mode] → [Rec Interval].  
(☞ P114 [ Rec Interval ] )

### 4 Start recording.

- Press the [REC] button to record only the number of frames specified in [Rec Frames] and pause.
- After the specified time in [Rec Interval] has passed, recording starts again to record only the number of frames specified in [Rec Frames] and pause.
- Interval Rec continues until the recording is stopped.  
The display changes (“STBY” → “●REC” → “STBY” (red text) → “●REC” → “STBY” (red text)).
- The card slot status indicator blinks in green.

### 5 Press and hold the [REC] button.

- The card slot status indicator lights up in green.
- The display becomes “STBY”.

Caution : \_\_\_\_\_

- Do not remove the SD card during recording (●REC, red text) or recording pause (STBY, yellow text).
- To remove the SD card during Interval Rec, press the [CANCEL] button, check that “STBY” (white text) is displayed and the card slot status indicator lights up in green before you remove the card.
- When [Main Menu] → [TC/UB] → [TC Generator] is set to “Free Run” or “Free Run(Ext)”, the time code will be recorded in “Rec Run”.
- Audio cannot be recorded. A ⊙ mark appears in the audio level meter display.  
(☞ P122 [Audio Level Meter] )

## Variable Frame Rec

Shooting in this mode allows you to obtain smooth slow motion or quick motion videos.

Using different frame rate settings for recording and playback, videos captured at normal speed can be played back more smoothly than those in low or high speed playback.

To enable Variable Frame Rec, the following two settings are required at the same time.

- [Record Format] → [A Resolution]/ [B Resolution] is set to “1920x1080” or “1280x720”.
- [Record Format] → [A Frame & Bit Rate]/ [B Frame & Bit Rate] is set to “30p(HQ)”, “24p(UHQ)”, “24p(HQ)” or “25p(HQ)”.

### Number of Frames that can be Set

#### 1 Set [A Resolution] and [A Frame & Bit Rate].

(☞ P112 [A Resolution])

(☞ P112 [A Frame & Bit Rate])

- [A Resolution]:  
Set to “1920x1080” or “1280x720”.
- [A Frame & Bit Rate]:  
Set to “30p(HQ)”, “24p(UHQ)”, “24p(HQ)” or “25p(HQ)”.

#### 2 Set [Rec Mode] to “Variable Frame”.

(☞ P113 [Rec Mode])

Set [Main Menu] → [System] → [Record Set] → [Rec Mode] to “Variable Frame”.

#### 3 Select a recording frame rate from [A Frame & Bit Rate].

(☞ P112 [A Frame & Bit Rate])

The selectable frame rates are as shown in the table below.

Resolution	Frame & Bit Rate	Selectable Shooting Frame Rate		
1920x1080	30p(HQ)	-	30	27, 25, 24, 22.5, 20, 18, 15, 12, 10, 6, 2
	24p(UHQ) 24p(HQ)	30, 27, 25	24	22.5, 20, 18, 15, 12, 10, 6, 2
	25p(HQ)	-	25	24, 22.5, 20, 18, 12.5, 10, 6, 2
1280x720	30p(HQ)	60, 54, 50, 48, 45, 40, 36, 32	30	27, 25, 24, 22.5, 20, 18, 15, 12, 10, 6, 2
	24p(HQ)	60, 54, 50, 48, 45, 40, 36, 32, 30, 27, 25	24	22.5, 20, 18, 15, 12, 10, 6, 2
	25p(HQ)	50, 48, 45, 40, 36, 32	25	24, 22.5, 20, 18, 12.5, 10, 6, 2
Effect during playback		Slow motion	Standard	Quick motion

Memo : \_\_\_\_\_

- When [Main Menu] → [Camera Function] → [AE LEVEL SW] is set to “AE LEVEL/VFR”, you can use the cross-shaped button (◀▶) to select the frame rate during Variable Frame Rec. In modes other than Variable Frame Rec, the cross-shaped button (◀▶) functions as the AE level setting button.  
(☞ P95 [AE Level])
- If the specified amount is not reached when recording is stopped, normal recording is performed and frames are added to the ending of the clip until the amount is reached. (Padding)

Caution : \_\_\_\_\_

- The shooting frame rate cannot be changed during recording. To change the frame rate, stop the recording first and perform the change.
- When [Main Menu] → [TC/UB] → [TC Generator] is set to “Free Run” or “Free Run(Ext)”, the time code will be recorded in “Rec Run”.
- Audio cannot be recorded. A ⊖ mark appears in the audio level meter display.  
(☞ P122 [Audio Level Meter])

# Playing Recorded Clips

To play back clips recorded on SD cards, switch to the Media mode.

Press and hold the [MODE] selection button in Camera mode to enter Media mode. A thumbnail screen of the clips recorded on the SD card is displayed.

You can play back the selected clip on the thumbnail screen.

Memo : \_\_\_\_\_

- When an SD card without any clips is inserted, "No Clips" is displayed.

## Operation Buttons

Use the operation buttons, on the side control panel of the camera recorder or the LCD monitor, to operate the thumbnail screen.

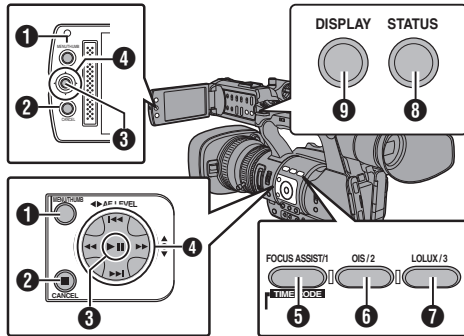

- [MENU/THUMB] Button**
  - Displays the menu.
  - Press this button to close the menu screen during menu display and return to the thumbnail screen.
- [CANCEL] (Stop) Button**
  - Cancels settings and returns to the previous screen.
- Set (Play) Button**
  - Sets the values and items. (Confirm)
  - Plays back the selected clip.
- Cross-Shaped Button (▲▼◀▶)**
  - Moves the cursor.
- [FOCUS ASSIST/1] Button**
  - Switches the OK mark of the clip selected by the cursor.
  - If an OK mark has been appended, it will be deleted. Otherwise, an OK mark will be appended.

- [OIS/2] Button**
  - Switches the selection status of the clip selected by the cursor.
  - Clips being selected are displayed with check mark.
- [LOLUX/3] Button**
  - Enters the action selection screen.
- [DISPLAY] Button**
  - Switches between the "Standard Screen" and "Detailed Screen".
- [STATUS] Button**
  - Displays the media information screen.

## Thumbnail Screen

- "Standard Screen" and "Detailed Screen" are available.
- Use the [DISPLAY] button to switch between the screens.
- Thumbnails are displayed in order of recording from the oldest to most recent.

### Standard screen

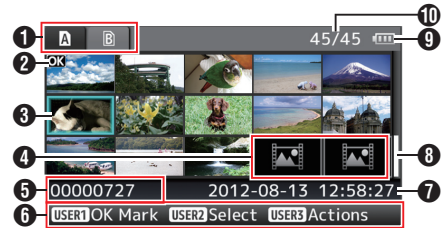

- SD Card Information**
  - Displays the status of the inserted SD card, selected SD card, write-protect switch, and the need for restoring.
  - Use the [SLOT A/B] switch to switch slots. Clips in slot A and B cannot be displayed at the same time.
  - A** : Write-protect switch of the SD card in slot A is set.
  - B!** : SD card in slot B needs to be restored or formatted, or is an unsupported SD card.

- Clip Mark**
  - Displays the clip information (properties).



- OK Mark**
  - Clip is appended with OK mark.

Memo : \_\_\_\_\_

- Clips appended with OK marks cannot be deleted on the camera recorder.
- When [Main Menu] → [System] → [Record Set] → [Record Format] → [A Format] is set to “AVCHD”, the OK mark indicates that the clip is protected.  
(☞ P112 [ A Format ] )

② Continued From Mark

This mark indicates that the current clip is continued from another SD card when recording is divided and made on several SD cards.

③ Uneditable Mark

- This mark indicates that an OK mark cannot be appended to or deleted from the clip, and the clip cannot be deleted.
- When [Main Menu] → [System] → [Record Set] → [Record Format] → [A Format] is set to “AVCHD”, clips that are not recorded on this camera recorder cannot be edited.

④ Continue Mark

This mark indicates that recording of the current clip is continued to another SD card when recording is divided and made on several SD cards.

⑤ Check Mark

- A green check mark is displayed when the clip is selected.
- Magenta and gray check marks are displayed in multiple selection mode.  
(☞ P89 [Selecting and Performing Operations on Multiple Clips] )

③ Cursor

Clip to be worked on. Use the cross-shaped button (▲▼◀▶) to move the cursor.

④ Thumbnail Substitution Display



- ① A clip with corrupted management information. It cannot be played back even if you press the Set (Play) button.
- ② A clip that cannot be played back nor displayed in thumbnail with the current video format settings. It cannot be played back even if you press the Set (Play) button.

Memo : \_\_\_\_\_

- Dependent on the settings for [Main Menu] → [System] → [Record Set] → [Record Format] → [System], [A Resolution]/[B Resolution], and [A Frame & Bit Rate]/[B Frame & Bit Rate].  
(☞ P111 [ System ] )  
(☞ P112 [ A Frame & Bit Rate ] )
- When [Record Format] → [A Format] is set to “AVCHD”, you may not be able to play back files recorded on a camera recorder other than the GY-HM600 and GY-HM650 series. If the file cannot be played back, the above thumbnail substitution display ② is displayed.

⑤ Clip Name

The file name (clip number) of the selected clip is displayed.

⑥ Operation Guide

- Displays a guide for the current operation buttons.
- The action selection screen is displayed when the User 3 ([LOLUX/3]) button is pressed.  
(☞ P85 [Actions] )

⑦ Recording Start Time

Displays the recording start time of the clip.

Memo : \_\_\_\_\_

- Data/time display depends on the [LCD/VF] → [Display Settings] → [Date Style]/[Time Style] settings in the [Main Menu] screen.  
(☞ P106 [ Date Style ] )  
(☞ P106 [ Time Style ] )

⑧ Scroll Bar

- Indicates the scroll position.
- Black space below the scroll bar (white) indicates that there are more pages.
- When the scroll bar (white) is at the bottom, this indicates the last page.

⑨ Remaining Battery Power

(☞ P30 [Power Status Display] )

⑩ Number of Clips

- If none of the clips are selected, the “running number/total number of clips” of the clip to be displayed appears.
- Even if only one clip is selected, the number of selected clips in the current slot is displayed.

## Detailed screen

\* Items that are common with the Standard screen will not be described. Refer to “[Standard screen] P 83”.

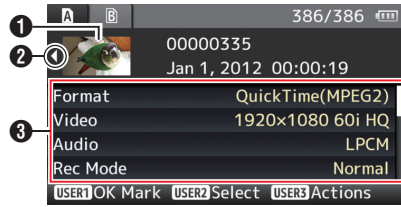

- 1 **Thumbnail**  
Thumbnail of the clip selected by the cursor.  
Use the cross-shaped button (◀▶) to move the cursor.
- 2 **Scroll Mark (◀▶)**
  - If there are previous clips, ◀ appears on the left.
  - If there are more clips, ▶ appears on the right.
  - The marks will not be displayed if there are no clips before and after the current clip.
- 3 **Metadata**  
Metadata of the clip pointed by the cursor.  
You can use the cross-shaped button (▲▼) to scroll.

## Actions

The action selection screen is displayed when the User 3 ([LOLUX/3]) button is pressed.

You can perform the following operations.

Item	Description
Select All Clips	Selects all clips.
Select OK Marked	Selects all clips appended with OK mark.
Select Range	Specifies the range when selecting multiple clips. (P89 [Selecting Multiple Clips Randomly])
Deselect All	Clears all clip selections.
Add OK Mark	Appends an OK mark. <ul style="list-style-type: none"> <li>• This Clip: Appends an OK mark to the clip pointed by the cursor.</li> <li>• Selected Clips: Appends an OK mark to the clips selected (appended with check mark).</li> <li>• All Clips: Appends an OK mark to all clips.</li> </ul>
Delete OK Mark	Deletes the OK mark. <ul style="list-style-type: none"> <li>• This Clip: Deletes the OK mark of the clip pointed by the cursor.</li> <li>• Selected Clips: Deletes the OK mark of the clips selected (appended with check mark).</li> <li>• All Clips: Deletes the OK mark of all clips.</li> </ul>

Item	Description
FTP Upload	<p>Uploads a clip to the FTP server.</p> <ul style="list-style-type: none"> <li>• This Clip: Uploads the clip pointed by the cursor.</li> <li>• Selected Clips: Uploads the clips selected (appended with check mark).</li> <li>• All Clips: Uploads all clips.</li> </ul>
Delete Clips	<p>Deletes clip. However, clips with OK mark cannot be deleted.</p> <ul style="list-style-type: none"> <li>• This Clip: Deletes the clip pointed by the cursor.</li> <li>• Selected Clips: Deletes the clips selected (appended with check mark).</li> <li>• All Clips: Deletes all clips.</li> </ul>

Memo : \_\_\_\_\_

- The object of action is the clip of the current slot being displayed.
- [Selected Clips] cannot be performed if there are no selected (appended with check mark) clips.
- [This Clip] cannot be performed if there are more than one selected (appended with check mark) clips.
- If the write-protect switch of an SD card is set, OK mark cannot be appended or deleted, and the clips cannot be deleted.

## Playing back

Use the operation buttons on the side control panel of the camera recorder to play back.

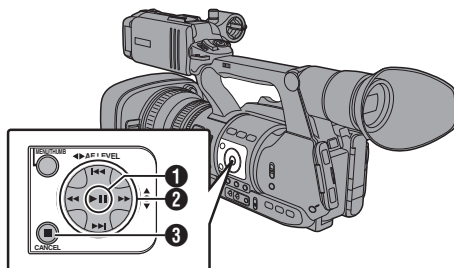

### 1 ►|| Button

- Plays back/pauses the clip pointed by the cursor.
- You can press the cross-shaped button (◀▶) to perform frame-by-frame forward playback during pause mode.

### 2 ◀▶/▶| Button

Skips in the reverse or forward direction.

### ◀▶▶| Button

During Playback:

Fast forwards in the reverse or forward direction.

While paused:

Frame-by-frame playback in the reverse or forward direction.

### 3 ■ Button

Stops playback.

### 1 In the thumbnail screen, move the cursor to the clip to be played back.

Move the cursor to the clip to be played back using the cross-shaped button (▲▼◀▶).

### 2 Press the playback/pause button.

Playback of the selected clip starts.

## Audio Output during Playback

- You can confirm the playback sound from the monitor speaker, or the headphone connected to the [Ω] terminal. When a headphone is connected to the [Ω] terminal, sound cannot be output from the monitor speaker.  
(P137 [Connecting the Headphone])
- Adjust the volume of the monitor speaker and headphone using the [MONITOR +/-] volume adjustment button on the LCD monitor section of the camera recorder.

## Time Code Playback

Time code or user's bit recorded on an SD card can be displayed on the LCD monitor and viewfinder.

Memo : \_\_\_\_\_

- The time code is also superimposed on the video signal output from the [HD/SD SDI] output terminal.
- User's bit output from the [HD/SD SDI] output terminal is used as a flag to determine valid video signals. Therefore, accurate values will not be output.
- If a section without time code is played back, the time code will stop. However, playback will continue.

## Displaying Information during Shooting

During playback, pressing the [DISPLAY] button shows the display screen.

Pressing the [AE LOCK/4] button switches the display information during shooting between no display, camera information display, and GPS display.

- The GPS display displays information on the recording location of the video being played back only when GPS information has been recorded.

The local date/time is displayed.

- Camera information display displays only information of Gain, Iris, Shutter and White Balance that have been recorded.

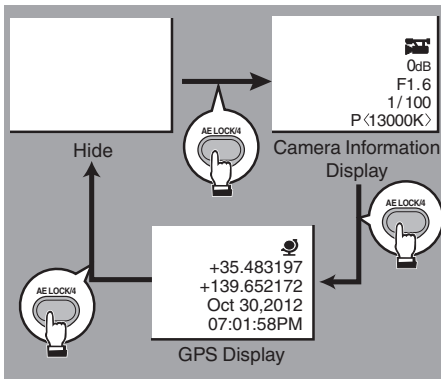

Memo : \_\_\_\_\_

- When [System] → [Record Set] → [Record Format] → System is set to "HD+SD" or "HD+Web", only SD or web files can be played back from slot B.  
In this case, files up-converted into the HD size are played back in the simple mode.

## Deleting Clips

Delete clip.

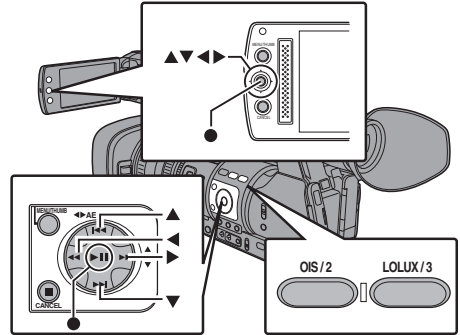

Memo : \_\_\_\_\_

- Clips appended with OK marks cannot be deleted on the camera recorder.
- Read-only clips can be deleted on a PC.

## Deleting One Clip

Delete the clip (one clip) pointed by the cursor in [Delete Clips] → [This Clip] in the menu.

Memo : \_\_\_\_\_

- Clips with OK mark cannot be deleted.

## During Thumbnail Screen

- 1 **Move the cursor to the clip to be deleted.**  
Move the cursor to the clip to be deleted using the cross-shaped button (▲▼◀▶).



- 2 **Press the [LOLUX/3] button.**  
The action selection screen is displayed.

- 3 Select [Delete Clips] → [This Clip] and press the Set button (●).

A screen to confirm deletion appears.

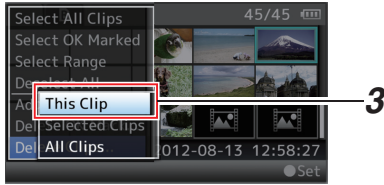

- 4 Select [Delete] using the cross-shaped button (▲▼), and press the Set button (●). Deleting starts.

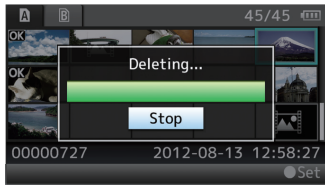
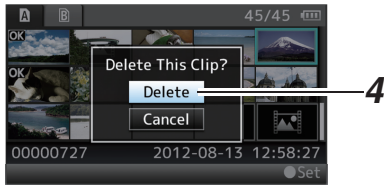

## Appending/Deleting OK Mark

- You can append OK marks to the clips for important scenes.
- Clips appended with OK marks cannot be deleted, thus protecting the important clips.
- When the camera recorder is in Media mode, you can delete the OK marks appended during recording, or append/delete OK marks after shooting.

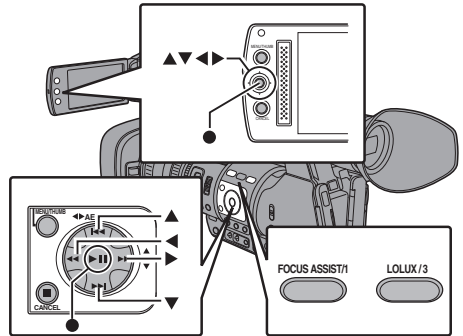

### During Thumbnail Screen

- 1 Press the [FOCUS ASSIST/1] button.
  - If the clip does not have an OK mark, an OK mark will be appended.
  - If the clip is appended with an OK mark, the OK mark will be deleted.

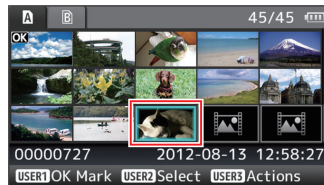

## Selecting and Deleting Multiple Clips

To select and delete multiple clips, refer to "[Selecting and Performing Operations on Multiple Clips] P 89".

## Deleting All Clips

Delete all clips that are displayed.

- 1 Press the [LOLUX/3] button.  
The action selection screen is displayed.
- 2 Select [Delete Clips] → [All Clips].  
A screen to confirm deletion appears.
- 3 Select [Delete] and press the Set button (●).  
Deleting starts.

Memo : \_\_\_\_\_

- The time taken to delete clips depends on the number of clips to be deleted.

## During Playback or Pause Screen

### 1 Press [FOCUS ASSIST/1] button during clip playback.

- If the clip does not have an OK mark, an OK mark will be appended.
- If the clip is appended with an OK mark, the OK mark will be deleted.



Memo : \_\_\_\_\_

- The clip pauses when an OK mark is appended or deleted during playback.

## Appending/Deleting OK Mark of Multiple Clips

To select and append/delete OK mark for multiple clips, refer to “[Selecting and Performing Operations on Multiple Clips] P 89”.

## Selecting and Performing Operations on Multiple Clips

- Multiple clips can be selected during thumbnail screen or playback screen display.
- After selecting multiple clips, perform appending/deleting of OK mark, deleting of clips using the action selection screen.
- After selecting multiple clips, the selections will be canceled by the following operations.
  - When [Deselect All] in the action menu is selected
  - When exiting Media mode from the thumbnail screen
  - When removing the SD card
  - When switching the slot in use

### Selecting Multiple Clips Randomly

#### 1 Move the cursor to a clip without check mark and press the [OIS/2] button.

A green check mark appears on the clip.

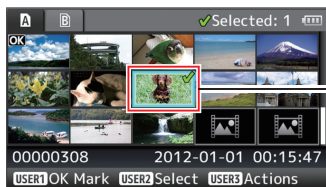

#### 2 Repeat Step 1 to select multiple clips.

- Multiple clips can be selected.
- Press the [LOLUX/3] button while the multiple clips are selected.
  - Appends OK mark together: [Add OK Mark] → [Selected Clips]
  - Deletes OK mark together: [Delete OK Mark] → [Selected Clips]
  - Uploading selected clips to the FTP server together: [FTP Upload] → [Selected Clips]
  - Deletes selected clips together: [Delete Clips] → [Selected Clips]

Memo : \_\_\_\_\_

- Selecting clips appended with check mark and pressing the [OIS/2] button will cancel the selection.
- If the operation is performed on multiple clips at the same time, a progress bar appears. You can stop the operation by pressing the Set button (●) while the operation is in progress. However, it is not possible to undo operations that are completed.

## Selecting Multiple Clips Consecutively

- 1 Press the [LOLUX/3] button.
- 2 Select “Select Range” in the action selection screen, and press the Set button (●).

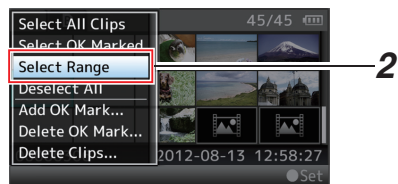

- 3 Move the cursor to the beginning (or end) of the range for multiple selection, and press the Set button (●).

- 4 Move the cursor to the other end of the range.
  - Magenta check marks appear on the clips within the range. (Including clips that were already selected.)
  - Gray check marks appear on selected clips that are outside the range.

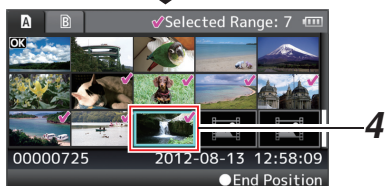
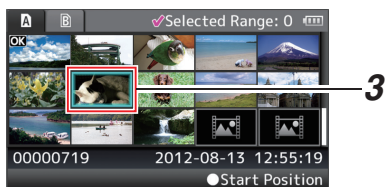

- 5 Press the Set button (●) to confirm the range.

- The check marks change from magenta to green.
- Pressing the [LOLUX/3] button while the multiple clips are selected displays the action selection screen. The following operations can be performed.
  - Appends OK mark together: [Add OK Mark] → [Selected Clips]
  - Deletes OK mark together: [Delete OK Mark] → [Selected Clips]
  - Uploading selected clips to the FTP server together: [FTP Upload] → [Selected Clips]
  - Deletes selected clips together: [Delete Clips] → [Selected Clips]

Memo : \_\_\_\_\_

- Selecting clips appended with check mark and pressing the [OIS/2] button will cancel the selection.
- If the operation is performed on multiple clips at the same time, a progress bar appears. You can stop the operation by pressing the Set button (●) while the operation is in progress. However, it is not possible to undo operations that are completed.

# Basic Operations in Menu Screen

- Press the [MENU/THUMB] button on the side control panel of the camera recorder or on the LCD monitor to display the menu screen on the LCD monitor and viewfinder.
- Various settings for shooting and playback can be configured on the menu screen.
- There are two types of menu screens - [Main Menu] and [Favorites Menu].
- [Main Menu] contains all the setting items of the camera recorder, classified according to functions and uses, while [Favorites Menu] allows users to customize the menu items freely. (☞ P117 [Adding/Editing Frequently Used Menu Items (Favorites Menu)])
- The operating procedures and main screen displays are the same for both menus.
- The menu screen can also be displayed on external monitors connected to the video signal output terminal. (☞ P107 [Display On TV])

## Operation Buttons

Use the operation buttons on the side control panel of the camera recorder or the buttons on the LCD monitor to operate the menu.

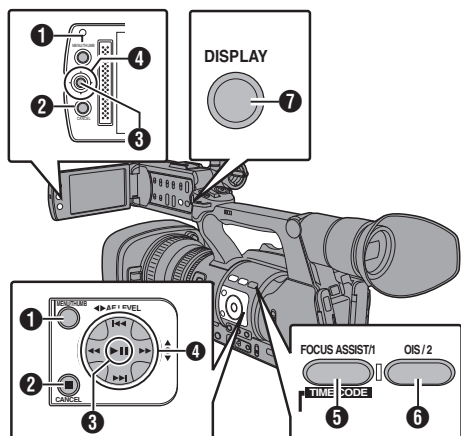

- [MENU/THUMB] Button**
  - Displays the menu screen. The [Main Menu] screen is displayed by default.
  - During normal usage, [Main Menu] is displayed if the previous menu operation ended at [Main Menu], and [Favorites Menu] if the previous menu operation ended at [Favorites Menu].
  - Press this button to close the menu screen during menu display and return to the normal screen.
- [CANCEL] Button**  
Cancels settings and returns to the previous screen.
- Set Button (●)**  
Sets the values and items.
- Cross-shaped Button (▲▼◀▶)**
  - ▲ : Moves the cursor upward.
  - ▼ : Moves the cursor downward.
  - ◀ : Moves back to the previous item.
  - ▶ : Moves forward to the next item.
- [FOCUS ASSIST/1] Button**  
Adds the selected menu or submenu item to the [Favorites Menu]. (☞ P117 [Adding/Editing Frequently Used Menu Items (Favorites Menu)])
- [OIS/2] Button**  
Resets settings in the [TC Preset] or [UB Preset] setting screen. This button is disabled in other screens.
- [DISPLAY] Button**  
Switches between the [Main Menu] and [Favorites Menu] screens.

## Display and Description of the Menu Screen

### Selecting Menu Items

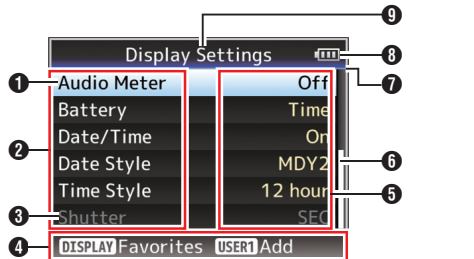

- 1 Cursor  
Indicates the selected item. Use the cross-shaped button (▲▼) to move the cursor
- 2 Menu Item
  - Displays the names of the menu item and sub-menu.
  - Menu items with [...] after them indicates that there is a sub-menu to access.
- 3 Fixed Item  
Items that cannot be changed are displayed in gray and cannot be selected.
- 4 Operation Guide  
Guide for the current operation buttons.
- 5 Setting Value  
Setting values for the menu items.  
For menus with sub-menus, values are not displayed.
- 6 Scroll Bar  
Indicates the scroll position.
- 7 Header  
Indicates the current menu type with the line color.
 

Blue	: [Main Menu] Screen
Green	: [Favorites Menu] (Operation screen)
Magenta	: [Favorites Menu] (Editing screen)
- 8 Remaining Battery Power  
(P30 [Power Status Display])

Memo : \_\_\_\_\_

- If the supplied battery (or equivalent battery sold separately) is not used, the battery mark which indicates the battery level may not appear.

- 9 Menu Title  
Title of the currently displayed menu.

### Changing Setting Values

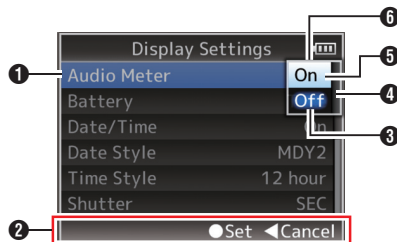

- 1 Menu Item to Change  
Menu item to be changed.  
A list of setting values 6 appears in a pop-up.
- 2 Operation Guide  
Guide for the current operation buttons.
- 3 Setting Values Before Change  
Setting values before changing. The background of the item is displayed in blue.
- 4 Scroll Bar  
Indicates the scroll position.
- 5 Cursor  
Indicates the selected item. Use the cross-shaped button (▲▼) to move the cursor
- 6 List of Setting Values
  - A pop-up displaying a list of setting values for selection.
  - The height of the pop-up depends on the number of settings available. Use the scroll bar 4 to confirm the current display status.

## Text Input with Software Keyboard

Use the software keyboard to enter the [Scene File]/[Picture File] submenu, [Clip Name Prefix], and the settings under [Network] → [Settings].

### [Scene File]/[Picture File]

(☞ P131 [Configuring Setup Files])

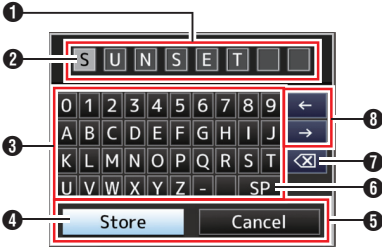

### [Clip Name Prefix]

(☞ P115 [Clip Name Prefix])

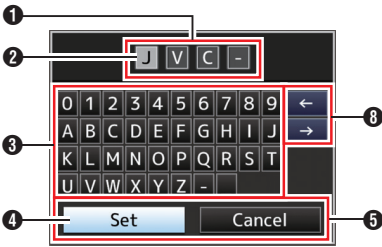

### Settings under [Network] → [Settings]

The keyboard displayed varies according to the settings.

(☞ P115 [Settings Item])

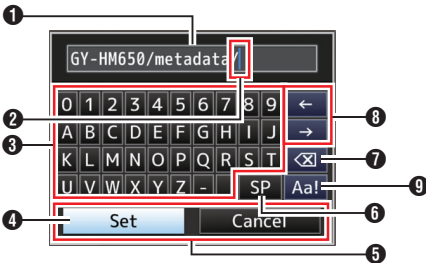

- 1 Character Entry Field
  - Field for entering the title.
  - You can enter up to 8 characters for the [Scene File]/[Picture File] submenu or up to 4 characters for the [Clip Name Prefix].
- 2 Character Cursor
 

Select a character using the key cursor 4, and press the Set button (●) to input the selected character at the position of the character cursor. The character cursor moves to the next position on the right each time a character is input. The cursor can be moved using the arrow keys 8.
- 3 Character Keys
 

Use the cross-shaped button (▲▼◀▶) to move the key cursor 4 to the character you want to enter.
- 4 Key Cursor
 

Indicates the currently selected character or item. Use the cross-shaped button (▲▼◀▶) to move the cursor.
- 5 Confirmation Buttons
  - Select [Set]/[Store] and press the Set button (●) to confirm the title.
  - Select [Cancel] and press the Set button (●) on the side control panel of the camera recorder to abort character input and return to the previous screen.
- 6 [SP] Space Key
 

Select [SP] and press the Set button (●) on the side control panel of the camera recorder to enter a space at the current position of the character cursor 2.
- 7 [⌫] Backspace Key
 

Select [⌫] and press the Set button (●) on the side control panel of the camera recorder to delete the character on the left of the character cursor 2.
- 8 Arrow Keys
 

Moves the position of the character cursor 2.
- 9 Character Switch Button
 

Switches the character buttons 3 to the upper case, lower case, and symbols.

# Menu Screen Hierarchical Chart

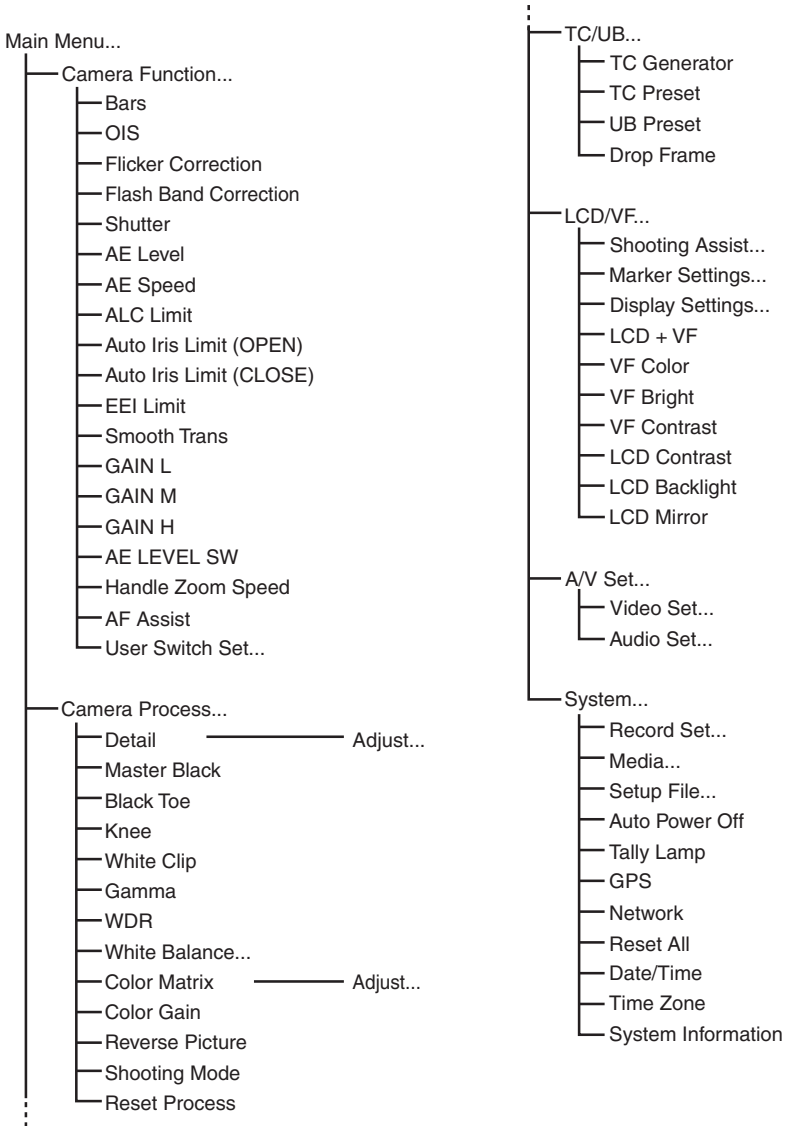

Memo : \_\_\_\_\_

- Some menus cannot be set depending on the operating mode or status of the camera recorder. These items are displayed in gray, and they cannot be selected.
- Setting value with the ● mark is the factory default.

# Camera Function Menu

Menu screen for specifying operation settings during shooting.

This item can only be selected in the Camera mode.

## Bars

For setting whether to output color bars.

[Setting Values: On, ●Off]

Memo : \_\_\_\_\_

- The audio test signals (1 kHz) can be output simultaneously with the color bar output. (P109 [ Test Tone ])

## OIS

For setting whether to enable image stabilizer.

When “On” is selected, set the Level.

[Setting Values: On, ●Off]

### ↳ Level

For setting the level of the image stabilizer.

[Setting Values: High, ●Normal]

Memo : \_\_\_\_\_

- When “High” is selected, correcting severe camera shake may cause the area surrounding the image to darken.

## Flicker Correction

For setting whether to adjust image flicker that occurs under a fluorescent light.

[Setting Values: On, ●Off]

## Flash Band Correction

For reducing the condition of the flash band phenomenon, which creates an unnatural image with a part of it brightly lit, such as by the camera flash of another still camera.

[Setting Values: On, ●Off]

Caution : \_\_\_\_\_

- Flash band correction function is not available in any of the following cases.
  - When [Rec Mode] is set to “Variable Frame”
  - When [A]Frame & Bit Rate/[B]Frame & Bit Rate is set to “24p(HQ)” or “24p(UHQ)”
  - When in the Automatic Shutter mode or when the shutter is turned on in the Manual Shutter mode (P54 [Manual Shutter Mode (Manual Shutter Switching)])
    - When [Network] is set to “On(SDI Off)” or “On(HDMI Off)”
- [Flash Band Correction] operates when the luminance of the screen varies widely, with or without flash light. However, depending on the shooting condition, the flash band correction may not be fully effective even if there are flash lights.
- The following symptoms may occur under flash light, but these are not malfunctions due to flash band correction.
  - Moving object appears to be stationary momentarily.
  - A horizontal line appears on the image.
- The [Flash Band Correction] function will be set to “Off” if the camera recorder switches from the Camera mode to another mode, or when the [POWER ON/OFF(CHG)] switch is set to “OFF(CHG)”.

## Shutter

For specifying shutter-related settings.

Use this item to set to “Step” (fixed value) or “Variable” when operating with the cross-shaped button (▲▼) on the right side.

- Variable:
  - Sets to variable scan. Use this setting such as when shooting a PC monitor.
- Step:
  - Sets to step shutter, which switches the shutter speed by a fixed value.

[Setting Values: Variable, ●Step]

## AE Level

For setting the convergence level during AE (Auto Exposure).

This can also be adjusted using the cross-shaped button (◀▶) on the right side.

[Setting Values: -6 to +6 (●0)]

## AE Speed

For setting the convergence speed during AE (Auto Exposure).

[Setting Values: ●Fast, Middle, Slow]

**ALC Limit**

For setting the maximum gain value of “ALC”, which electrically boosts the sensitivity level according to the brightness automatically.  
[Setting Values: 24dB, ●18dB, 12dB, 6dB]

**Auto Iris Limit (OPEN)**

For setting the limit value of the OPEN end when auto iris is enabled.  
[Setting Values: F5.6, F4, F2.8, F2, ●F1.6]

**Auto Iris Limit (CLOSE)**

For setting the limit value of the CLOSE end when auto iris is enabled.  
[Setting Values: F11, ●F8, F5.6]

**EELimit**

For setting the shutter speed control range when EEL is enabled.  
[Setting Values: 4F-stop, ●3F-stop, 2F-stop]

**Smooth Trans**

For setting the shock reduction function, which slows down the sudden change when switching with the [GAIN] or [WHT BAL] selection switch.  
[Setting Values: Fast, Middle, Slow, ●Off]

Memo : \_\_\_\_\_

- However, this function is disabled when the [FULL AUTO] switch is set to “ON”, or when switching the gain selection switch that was set to “ALC”.

**GAIN L/GAIN M/GAIN H**

For setting the gain value of each position on the [GAIN] selection switch.  
This is fixed at “ALC” when the [FULL AUTO] switch is set to “ON”.

[Setting Values: 24dB, 21dB, 18dB, 15dB, 12dB, 9dB, 6dB, 3dB, 0dB, -3dB, -6dB]

(Default values GAIN L: 0dB, GAIN M: 6dB, GAIN H: 12dB)

Memo : \_\_\_\_\_

- When [Shooting Mode] is set to “Standard”, “-3dB” and “-6dB” cannot be selected.

( P100 [ Shooting Mode ])

**AE LEVEL SW**

For specifying the operation of the cross-shaped button (◀▶) on the right side.

- AE LEVEL/VFR:  
Sets the number of frames during Variable Frame Rec, and operates as the AE level setting button in other cases.  
( P82 [Variable Frame Rec] )
- AE Level:  
Operates as the AE level setting button at all times.
- Disable:  
Disables the button.

[Setting Values: AE LEVEL/VFR, ●AE Level, Disable]

**Handle Zoom Speed**

This function allows you to set the zoom speed of the zoom lever at the handle when the [ZOOM FIX/VAR/OFF] switch is set to “FIX”.

[Setting Values: 1 to 8 (●5)]

**AF Assist**

For setting whether to allow temporary manual focus adjustment by turning the focus ring in the AF mode.

[Setting Values: On, ●Off]

Memo : \_\_\_\_\_

- This setting is effective only when the [FOCUS] switch is set to “AUTO”.
- The manual focus adjustment mode is temporarily activated by turning the focus ring in the AF mode. If the focus ring is not operated for a certain time, the camera recorder returns to the AF mode.

**User Switch Set...**

For specifying user button related settings.

( P97 [User Switch Set Item] )

## User Switch Set Item

### USER1 - USER7, LCD KEY▲/LCD KEY▶/LCD KEY▼/LCD KEY◀

By assigning one of the following functions to each of the [FOCUS ASSIST/1], [OIS/2], [LOLUX/3], [AE LOCK/4], [ZEBRA/5], [MARKER/6], [C.REVIEW/7] buttons or the cross-shaped buttons on the LCD monitor, these buttons can be used to control the assigned function (on/off, start, switch). Set according to the shooting conditions. Usable only in the Camera mode.  
[Setting Values: None, Zebra, Marker, Bars, Focus Assist, OIS, Flash Band, LCD Backlight, Lolux, AE Lock, Spot Meter, Face Detect, OK Mark, Clip Cutter Trig, Backup Trig, Clip Review, Load Picture File, White Balance, Preset Zoom1, Preset Zoom2, Preset Zoom3]

#### Lolux

To increase the sensitivity when in dim surroundings, set a value in the Lolux mode.  
[Setting Values: 36dB, ●30dB]

#### Clip Review

For specifying the operation when any of the [USER1]-[USER7], [LCD KEY▲], [LCD KEY▶], [LCD KEY▼], or [LCD KEY◀] items is set to "Clip Review".

- Last 5sec:  
Views about 5 seconds of the clip from the ending.
- Top 5sec:  
Views about 5 seconds of the clip from the beginning.
- Clip:  
Views the entire clip.

[Setting Values: ●Last 5sec, Top 5sec, Clip]

Memo : \_\_\_\_\_

- This item is selectable when any of the [USER1]-[USER7], [LCD KEY▲], [LCD KEY▶], [LCD KEY▼], [LCD KEY◀] items is set to "Clip Review".

### Spot Meter

For specifying the operation when any of the [USER1]-[USER7], [LCD KEY▲], [LCD KEY▶], [LCD KEY▼], or [LCD KEY◀] items is set to "Spot Meter".

(P70 [Setting Spot Meter])

- Max & Min:  
Displays the brightest and darkest areas of the image.
- Max:  
Displays the brightest area of the image.
- Min:  
Displays the darkest area of the image.
- Manual:  
Displays the image brightness at a specified position.

[Setting Values: ●Max & Min, Max, Min, Manual]

### Face Detect

For specifying the operation when any of the [USER1]-[USER7], [LCD KEY▲], [LCD KEY▶], [LCD KEY▼], or [LCD KEY◀] items is set to "Face Detect".

Select the control to track results of face detection.

- AF&AE:  
Sets auto focus and exposure control for the face that is being tracked.
- AF:  
Sets auto focus for the face that is being tracked.

[Setting Values: ●AF&AE, AF]

Memo : \_\_\_\_\_

- When "AF" is specified, this function will be activated only when the [FOCUS] switch is set to "Auto".  
When "AF&AE" is specified, this function will be activated only when the [FOCUS] switch is set to "Auto", or when one or more of the items (Gain, Iris and Shutter) is set to Auto mode.

### ↳ Sensitivity

For setting the level of ease of face detection.

[Setting Values: Low, Middle, ●High]

### ↳ Hysteresis

For setting the margin to maintain status when the face that is being tracked is lost.  
 Set to “Fast” to select another object immediately if the face on the screen is lost.  
 Set to “Slow” to operate at the same position for some time even if the face on the screen is lost.  
 [Setting Values: Fast, ●Middle, Slow]

### AE Lock

For specifying the operation when any of the [USER1]-[USER7], [LCD KEY▲], [LCD KEY▶], [LCD KEY▼], or [LCD KEY◀] items is set to “AE Lock”.

- AE:  
Use this feature to fix a value to the Auto function of Gain, Iris, or Shutter when the user button that is assigned “AE Lock” is pressed.
- AE/WB:  
Use this feature to fix a value to White Balance and the Auto function of Gain, Iris, or Shutter when the user button that is assigned “AE Lock” is pressed.

[Setting Values: ●AE, AE/WB]

Memo : \_\_\_\_\_

- This feature only works when Iris, Shutter or Gain is set to Auto mode.
- “AE Lock” is canceled when the button assigned with “AE Lock” is pressed, or when any of the functions that can be locked is operated regardless of Manual/Auto mode.

### Preset Zoom Speed

For setting the speed to shift to the preset zoom position that is assigned to a user button.  
 [Setting Values: 1 to 127 (●64)]

## Camera Process Menu

Menu screen for adjusting the quality of camera images.  
 This item cannot be selected in the Media mode.

### Detail

For adjusting the contour (detail) enhancement level.  
 Increasing the value increases the sharpness of the contour.  
 [Setting Values: -10 to +10, Off (●0)]

### ↳ Adjust...

For specifying the detailed settings of the contour (detail).  
 (P101 [Detail/Adjust Item] )

Memo : \_\_\_\_\_

- This item cannot be selected when [Detail] is set to “Off”.

### Master Black

For adjusting the pedestal level (master black) that serves as the reference black.  
 Increasing the value increases the pedestal.  
 [Setting Values: -50 to +50 (●-3)]

### Black Toe

Process the dark areas according to the balance of bright and dark areas in the image to adjust the overall balance of contrast.  
 For altering the gain of dark areas. Adjust this item according to the condition of the captured video signals.

- Stretch:  
Increases the gain of dark areas in an image to stretch the signals of these areas only, thereby showing the contrast between bright and dark areas more clearly.  
Specify the amount of stretch with [Stretch Level].
- Normal:  
Normal condition.
- Compress:  
Compresses the gain of dark areas to increase the contrast when the entire image appears bright and contrast is weak. Specify the compression amount with [Compress Level].

[Setting Values: Stretch, ●Normal, Compress]

Memo : \_\_\_\_\_

- When [WDR] is set to other than “Off”, this item appears as “---” and cannot be selected.

### ↳ Stretch Level

Stretch amount increases when a larger value is specified.  
 [Setting Values: 1 to 5 (●3)]

Memo : \_\_\_\_\_

- This item is displayed only when [Black Toe] is set to “Stretch”. Otherwise, this item appears as “---” and cannot be selected.

### ↳ Compress Level

Compression amount increases when a larger value is specified.

[Setting Values: 1 to 5 (● 3)]

Memo : \_\_\_\_\_

- This item is displayed only when [Black Toe] is set to "Compress". Otherwise, this item appears as "---" and cannot be selected.

### Knee

For specifying the "Knee" operation, which compresses video signals beyond a certain level to show the gradation of the highlighted portion. To check the gradation of a bright area, set to "Manual" and adjust the knee point (starting point of knee operation) manually.

- Manual:  
Enables manual adjustment of knee point using [Level].
- Auto:  
Adjusts the knee point automatically according to the luminance level.

[Setting Values: Manual, ●Auto]

Memo : \_\_\_\_\_

- When [WDR] is set to other than "Off", this item appears as "---" and cannot be selected.

### ↳ Level

For setting the starting point (knee point) of knee compression when [Knee] is set to "Manual".

[Setting Values: ●100%, 95%, 90%, 85%]

Memo : \_\_\_\_\_

- When [Knee] is set to other than "Auto", or [WDR] is set to other than "Off", this item appears as "---" and cannot be selected.

### ↳ Sensitivity

For setting the response speed of the "Knee" operation when [Knee] is set to "Auto". Set to "Slow" when shooting an object under a condition where there is drastic change in the light intensity.

[Setting Values: ●Fast, Middle, Slow]

Memo : \_\_\_\_\_

- When [Knee] is set to "Manual", or [WDR] is set to other than "Off", this item appears as "---" and cannot be selected.

### White Clip

For setting the point to apply white clip for input video signals with a high luminance level.

- 108%:  
Applies white clip at the point where the luminance level is 108 %.
- 100%:  
Applies white clip at the point where the luminance level is 100 %. Even when this item is set to "108%", it switches automatically to "100%" if the screen appears too white. Set to this value when the system in use limits Y output signals within 100 %.

[Setting Values: ●108%, 100%]

Memo : \_\_\_\_\_

- When [WDR] is set to other than "Off", this item appears as "108%" and cannot be selected.

### Gamma

For adjusting the gamma curve that determines the gradation expression.

- Cinema:  
Sets to a gamma curve with similar gradation to the screen characteristics of movies.
- Standard:  
Sets to a standard gamma curve.

[Setting Values: Cinema, ●Standard]

Memo : \_\_\_\_\_

- When [WDR] is set to other than "Off", this item appears as "---" and cannot be selected.

### ↳ Gamma Level

This item can be specified separately when [Gamma] is set to "Standard" or "Cinema".

- Increase the number:  
Enhances the gradation of black. However, the gradation of bright areas deteriorates.
- Decrease the number:  
Enhances the gradation of bright areas. However, the gradation of black deteriorates.

[Setting Values: -5 to +5 (● 0)]

### WDR

For setting the WDR (Wide Dynamic Range) function.

When shooting object with wide dynamic range due to backlight conditions, this function compresses the dynamic range while maintaining image contrast through providing gradation compensation to the input video signals.

- **Strong:**  
Enhances the effect of gradation compensation for object with wide dynamic range due to outdoor or strong backlight conditions.
- **Natural:**  
Normal setting for wide dynamic range.
- **Weak:**  
Reduces the effect of gradation compensation compared to the normal setting.
- **Off:**  
Sets the wide dynamic range function to "Off".

[Setting Values: Strong, Natural, Weak, ●Off]

Memo : \_\_\_\_\_

- When [WDR] is set to other than "Off", [Black Toe], [Knee], [Gamma] and [White Clip] cannot be selected.

### White Balance...

Menu for adjusting white balance.  
( P102 [White Balance Item])

- \* For details, refer to "[Adjusting the White Balance] P 56".

### Color Matrix

For setting the color matrix.

- **Cinema Subdued:**  
Sets to a subdued color matrix that is similar to the screen characteristics of movies.
- **Cinema Vivid:**  
Sets to a vivid color matrix that is similar to the screen characteristics of movies.
- **Standard:**  
Sets to a standard color matrix.
- **Off:**  
Sets the color matrix function to Off.

[Setting Values: Cinema Subdued, Cinema Vivid, ●Standard, Off]

### Adjust

This item is used to adjust [Color Matrix] to a color according to the user's preference.

- This item is used to adjust [Color Matrix] to a color according to the user's preference.
- The saturation, hue and brightness of the primary and complementary colors (6 colors in total) can be set individually.
- The adjusted values of "Standard", "Cinema Vivid", and "Cinema Subdued" in [Color Matrix] can be stored individually.  
( P130 [Adjusting Color Matrix])

[Setting range for Lightness/Saturation: -10 to +10]  
(roughly  $\pm 10\%$ )

[Setting range for Hue: -5 to +5] (roughly  $\pm 5^\circ$ )

Memo : \_\_\_\_\_

- This item cannot be selected when [Color Matrix] is set to "Off".

### Color Gain

For adjusting the video signal color level.  
Increasing the value deepens the color.  
[Setting Values: -50 to +15, Off (●0)]

Memo : \_\_\_\_\_

- Images are displayed in black-and-white when this is set to "Off".

### Reverse Picture

For recording images correctly by setting this item to "Rotate" when the lens image appears upside down or laterally inverted.

- **Rotate:**  
Enables horizontal/vertical inversion of the image.
- **Off:**  
Disables horizontal/vertical inversion of the image.

[Setting Values: Rotate, ●Off]

### Shooting Mode

For switching the settings for image recording on the camera.

- **Standard:**  
Normal shooting mode.  
This setting is suitable for shooting low-noise image quality.  
Use this mode in well lit places.
- **Extended:**  
High sensitivity shooting mode.  
This setting enables recording in various brightness conditions.  
Use this mode in places where the lighting is difficult to control and the brightness is insufficient.

[Setting Values: ●Standard, Extended]

### Reset Process

Restores all items in the [Camera Process] menu to their default settings.

## Detail/Adjust Item

### V/H Balance

For setting the H/V balance to enhance contour (detail) in the horizontal (H) or vertical (V) direction.

- H+1 to H+4:  
Increasing the value enhances contour in the horizontal direction.
- V+1 to V+4:  
Increasing the value enhances contour in the vertical direction.

[Setting Values: H+1 to H+4, ●Normal, V+1 to V+4]

Memo : \_\_\_\_\_

- When [System] under [Record Format] is set to “SD”, this item is fixed at “Normal”.
- When [System] under [Record Format] is set to “HD+SD”, this item can be set during HD recording, but will be fixed at “Normal” during SD recording.

### H Frequency

For specifying the correction frequency of the horizontal contour. Set this according to the object.

- High:  
Emphasizes the high frequency range. Use this when shooting objects with fine patterns.
- Middle:  
Emphasizes the intermediate frequency range.
- Low:  
Emphasizes the low frequency range. Use this when shooting objects with large patterns.

[Setting Values: High, ●Middle, Low]

Memo : \_\_\_\_\_

- When [System] under [Record Format] is set to “SD”, this item is fixed at “Low”.
- When [System] under [Record Format] is set to “HD+SD”, this item can be set during HD recording, but will be fixed at “Low” during SD recording.

### V Frequency

For specifying the correction frequency of the vertical contour. Set this according to the object.

- Low:  
Emphasizes the low frequency range.
- Middle:  
Emphasizes the intermediate frequency range.
- High:  
Emphasizes the high frequency range.

[Setting Values: Low, ●Middle, High]

Memo : \_\_\_\_\_

- When [System] under [Record Format] is set to “SD”, this item is fixed at “Low”.  
(P111 [Record Format])
- When [System] under [Record Format] is set to “HD+SD”, this item can be set during HD recording, but will be fixed at “Low” during SD recording.
- “High” cannot be selected under the following settings.
  - When [A Resolution] is set to “1920x1080”, and [A Frame & Bit Rate] is set to “60i(HQ)” or “50i(HQ)”.
  - When [A Resolution] is set to “1440x1080”, and [A Frame & Bit Rate] is set to “60i(HQ)”, “50i(HQ)”, “60i(SP)” or “50i(SP)”.

### Skin Detail

For turning On/Off the Skin Detail function, which is used to adjust the contour correction effect of the colors captured.

Select “On” to soften the detail at areas where skin tone is detected.

[Setting Values: On, ●Off]

#### ↳ Level

For setting the level of contour correction (degree of softening) using the Skin Detail function. Decreasing the value increases the level of contour correction (degree of softening).

[Setting Values: -1, ●-2, -3]

#### ↳ Range

For adjusting the range of skin tone to trigger the Skin Detail function.

Increasing the value increases the range.

[Setting Values: -5 to +5 (●0)]

## White Balance Item

### Preset Temp.

For setting the color temperature when the [WHT BAL] switch is set to "PRESET".

For details, refer to "[Adjusting the White Balance] P 56".

### Alternative Temp.

For setting the alternative color temperature in the Preset mode.

When the [WHT BAL] switch is set to "PRESET", pressing the  button each time switches the color temperature setting in the Preset mode.

([Preset Temp.] ↔ [Alternative Temp.]

For details, refer to "[Adjusting the White Balance] P 56".

### AWB Paint

For adjusting the R (red)/B (blue) component in the AWB (Auto White Balance) mode.

For details, refer to "[Adjusting the White Balance] P 56".

- Increase the number:  
Strengthens the red/blue.
- Decrease the number:  
Weakens the red/blue.

[Setting Values: -32 to +32 (● 0)]

Memo : \_\_\_\_\_

- This item is selectable when the [WHT BAL] switch on the right of the camera recorder is set to "A" or "B". When "PRESET" is set, this item appears as "--" and cannot be selected.
- Different values can be specified for "A" and "B".
- After the  (Auto White Balance) button is pressed to readjust the white balance while [Clear Paint After AWB] is set to "On", R and B values switch automatically to "0".

### Clear Paint After AWB

For specifying whether to clear the [AWB Paint] (R value and B value) settings after executing AWB (Auto White Balance).

- On:  
Sets the [AWB Paint] (R value and B value) settings to "0" after executing AWB (Auto White Balance).

- Off:  
Does not change the [AWB Paint] (R value and B value) settings after executing AWB (Auto White Balance).

[Setting Values: ●On, Off]

### FAW Paint

For adjusting the R (red)/B (blue) component during FAW (Full Auto White Balance) mode.

- Increase the number:  
Strengthens the red/blue.
- Decrease the number:  
Weakens the red/blue.

[Setting Values: -32 to +32 (● 0)]

## TC/UB Menu

Menu screen for setting time code and user's bit. This item cannot be selected in the Media mode, or during recording.

### TC Generator

For setting the operation of the time code.

- Free Run(Ext):  
External time code input will be synchronized with this and the time code will be recorded.
- Free Run:  
The time code operates in the run mode at all times regardless of the recording status. It continues to run even when the power of the camera recorder is turned off.
- Rec Run:  
The time code operates in the run mode during recording. It continues to run in the order of the recorded clips as long as the SD card is not replaced. If the SD card is removed and recording is made on another card, time code will be recorded on the new card from where it was left off in the previous card.
- Regen:  
The time code operates in the run mode during recording. When the SD card is replaced, the last time code recorded on the card is read and recorded on a new card so that the time code continues in running order.

[Setting Values: Free Run(Ext), Free Run, ●Rec Run, Regen]

## TC Preset

For setting the time code (hour, minute, second, frame).

Display : Drop setting 02:02:25.20  
: Non Drop setting 02:02:25:20

## UB Preset

For setting the user's bit. (Digit by digit)

Display : AB CD EF 01

## Drop Frame

For setting the framing mode of the time code generator.

- Non Drop:  
Internal time code generator works in the non-drop-frame mode. Use this setting when placing emphasis on the number of frames.
- Drop:  
Internal time code generator works in the drop-frame mode. Use this setting when placing emphasis on the recording time.

[Setting Values: Non Drop, ●Drop]

Memo : \_\_\_\_\_

- This item can be set only when [Main Menu] → [System] → [Record Set] → [Record Format] → [A]Frame & Bit Rate is set to "60p", "30p", or "60i". When the frame rate is "24p", "Non Drop" becomes fixed and cannot be selected. When the frame rate is "50p", "25p", or "50i", this item appears as "---" and cannot be selected. (P112 [A] Frame & Bit Rate )

# LCD/VF Menu

Item for specifying settings related to the LCD monitor or viewfinder screen.

This menu screen can be used to specify settings related to the Focus Assist mode, zebra pattern display, screen size, marker, and safety zone. In addition, it is also used for selecting whether to display characters on the LCD monitor or viewfinder screen, as well as for adjusting the picture quality of the LCD monitor.

## Shooting Assist...

Menu for setting the Shooting Assist function.

(P104 [Shooting Assist Item] )

## Marker Settings...

For setting items such as the safety zone and center mark.

(P105 [Marker Settings Item] )

## Display Settings...

For specifying display-related settings.

(P105 [Display Settings Item] )

## LCD + VF

For selecting a method to switch between the LCD monitor and viewfinder screen displays.

(P36 [Adjusting the LCD Monitor and Viewfinder] )

- On:  
Displays images on the viewfinder at all times.
- Off:  
Turns off the viewfinder screen display when the LCD monitor is turned on.

[Setting Values: On, ●Off]

## VF Color

For selecting whether to display the image on the viewfinder screen in color or black-and-white.

Select "On" to display in color, and "Off" to display in black-and-white.

[Setting Values: ●On, Off]

Memo : \_\_\_\_\_

- The setting of this item is valid only in Camera mode.
- When this item is set to "Off", only the captured images are displayed in black-and-white. The display and menu screens are displayed in color.
- When [Network] is set to "On", this item is fixed at "Off" and cannot be selected.

**VF Bright**

For setting the brightness of the viewfinder screen. Increasing the value increases the brightness. [Setting Values: -10 to +10 (● 0)]

**VF Contrast**

For setting the difference in luminance between the darkest and brightness areas in the viewfinder screen. Increasing the value increases the contrast. [Setting Values: -10 to +10 (● 0)]

**LCD Contrast**

For setting the difference in luminance between the darkest and brightness areas in the LCD monitor. Increasing the value increases the contrast. [Setting Values: -10 to +10 (● 0)]

**LCD Backlight**

For setting the brightness of the LCD monitor backlight. [Setting Values: Bright, ●Normal]

**LCD Mirror**

For specifying the image display method when facing the LCD monitor. Select "Mirror" to display the image after laterally inverting it. (Mirror display)  
( P36 [Adjusting the LCD Monitor and Viewfinder] )  
[Setting Values: Mirror, ●Normal]

Memo : \_\_\_\_\_

- The setting of this item is valid only in Camera mode.
- During color bar, menu screen and status screen display, the "Mirror" setting is disabled. ( P129 [Color Bar Output] )

**Shooting Assist Item****Focus Assist**

For setting whether to add color to the contour of the focused image upon switching the image to black-and-white. [Setting Values: On, ●Off]

**↳ Type**

For specifying the operation when the [FOCUS ASSIST/1] button is pressed.

( P49 [Focus Assist Function] )

- **ACCU-Focus:**  
Enables the Focus Assist and ACCU-Focus (forced focus) functions. The depth of field of the object becomes shallower to enable easier focusing. The ACCU-Focus function switches automatically to "Off" after about 10 seconds.
- **Normal:**  
Enables only the Focus Assist function. The focused area is displayed in color to enable easier focusing. Display color can be specified with [Color].

[Setting Values: ACCU-Focus, ●Normal]

**↳ Color**

For setting the display color of the focused area when Focus Assist is activated.

[Setting Values: ●Blue, Green, Red]

**Zebra**

For selecting whether to display zebra patterns at the bright areas of the subject. Select "On" to display zebra patterns or "Off" to hide.

[Setting Values: On, ●Off]

**↳ Top**

For setting the maximum luminance level for the zebra pattern display.

[Setting Values: Over, 100% to 5% (in 5% increments)] (●80%)

**↳ Bottom**

For setting the minimum luminance level for the zebra pattern display.

[Setting Values: 100% to 0% (in 5% increments)] (●70%)

Memo : \_\_\_\_\_

- The relation between Top and Bottom is such that Top>Bottom always holds. To maintain this relation when setting Top, the Bottom value is automatically corrected.

## Marker Settings Item

For setting the marker and safety zone, which are useful in helping you determine the angle of view for the image according to the shooting purpose.

( P129 [Marker and Safety Zone Displays (Camera Mode Only)])

Memo : \_\_\_\_\_

- During Clip Review or when in the Media mode, the markers do not appear regardless of the setting.

### Marker Settings

For setting whether to display marker, safety zone, and center marks on the screen.

[Setting Values: On, Off]

#### ↳ Aspect Ratio

For selecting the final image aspect ratio to be used from the overall angle of view.

[Setting Values: 16:9(+4:3), 2.35:1, 1.85:1, 16:9, 1.75:1, 1.66:1, 14:9, 13:9, 4:3, 2.35:1 Center, 2.35:1 Top, 1.85:1 Center, 1.85:1 Top]

Memo : \_\_\_\_\_

- When [System] → [Record Set] → [Record Format] → [SD Aspect] is set to “4:3”, this item is fixed at “4:3” and cannot be selected.

( P113 [ SD Aspect ])

#### ↳ Aspect Marker

For specifying how boundary markers are to be used to indicate the parts of an image that are beyond the range of the aspect ratio selected in [Aspect Ratio].

- Line+Halftone:  
Displays the boundary using lines, and areas outside the boundary in halftone.
- Halftone:  
Displays areas outside the boundary in halftone.
- Line:  
Displays the boundary using lines.
- Off:  
Hides the boundary markers.

[Setting Values: Line+Halftone, Halftone, Line, Off]

Memo : \_\_\_\_\_

- When [Aspect Ratio] is set to “16:9” or “16:9(+4:3)”, this item is fixed at “Off” and cannot be selected.

#### ↳ Safety Zone

For setting the percentage of area that is to be deemed as valid area (Safety Zone) within the boundary of the aspect ratio selected in [Aspect Ratio].

[Setting Values: 95%, 93%, 90%, 88%, 80%, Off]

#### ↳ Center Mark

For specifying whether to display a mark to indicate the screen center within the aspect ratio selected in [Aspect Ratio].

[Setting Values: On, Off]

## Display Settings Item

This menu is used to set the displays on the LCD monitor and viewfinder screen.

### Zoom

For setting the display method of the zoom position.

- Number:  
Displays the zoom position in numbers (0-99).
- Bar:  
Displays the zoom position in a bar.
- Off:  
Does not display the zoom position.

[Setting Values: Number, Bar, Off]

### Focus

For setting the display method of the focal length during manual focus.

- Feet:  
Displays the focus in feet.
- Meter:  
Displays the focus in meters.
- Off:  
Does not display the focal length during focus.

[Setting Values: Feet, Meter, Off]

### ND Filter

For setting whether to display the filter position.

[Setting Values: On, Off]

### Record Format

For setting whether to display the video format during recording or playback.

[Setting Values: On, Off]

### Media Remain

For setting whether to display the remaining space of the recording SD card.

[Setting Values: ●On, Off]

Memo : \_\_\_\_\_

- When the remaining space warning is displayed, the information appears even when “Off” is selected.
- The displayed time is an estimate.

### TC/UB

For specifying whether to display the time code (TC) or user’s bit (UB) rate in the display on the LCD monitor and viewfinder screen.

[Setting Values: UB, ●TC, Off]

### Audio Meter

For specifying whether to display the audio level meter in the display on the LCD monitor and viewfinder screen.

[Setting Values: ●On, Off]

### Battery

For setting the display of the remaining battery power in the display on the LCD monitor and viewfinder screen.

The battery information appears only on the Display 1 screen in Camera mode.

( P121 [Display 1 screen] )

- Time:  
Displays the remaining battery power in minutes. (min)
- Capacity%:  
Displays the remaining battery power in percentage. (%)
- Voltage:  
Displays the current battery voltage in units of 0.1 V. (V)
- [Off]:  
The remaining battery power is not displayed.

[Setting Values: ●Time, Capacity%, Voltage, Off]

Memo : \_\_\_\_\_

- The battery mark that appears before the “Time”, “Capacity%” or “Voltage” value changes according to the remaining battery power.
  - : 10 % and below
  - : 11 % to 30 %
  - : 31% to 70 %
  - : 71 % to 100 %
- When the remaining battery power is low, “RES” instead of the value is displayed.  
Replace the battery as soon as possible.
- The remaining battery power and remaining time are intended as reference values for the shooting duration.

### Date/Time

For specifying whether to display the date and time in the display on the LCD monitor and viewfinder screen.

[Setting Values: ●On, Off]

### Date Style

For setting the date display sequence for display on the LCD monitor and viewfinder screen as well as for time stamp recording.

Display examples of the setting values are as follows.

- DMY2: 30 Jun 2012
- DMY1: 30-06-2012
- MDY2: Jun 30, 2012
- MDY1: 06-30-2012
- YMD: 2012-06-30

[Setting Values: DMY2, DMY1, MDY1, MDY2, YMD]

(Default values: MDY2 (U model), DMY1 (E model))

### Time Style

For setting the time display for display on the LCD monitor and viewfinder screen as well as for time stamp recording.

[Setting Values: 24hour, 12hour]

(Default values: 12hour (U model), 24hour (E model))

### Shutter

For setting the shutter display to be displayed on the LCD monitor and viewfinder screen.

- DEG:  
Displays the shutter speed in degrees in the same way as film cameras.
- SEC:  
Displays the shutter speed in seconds.

[Setting Values: DEG, ●SEC]

Memo : \_\_\_\_\_

- “DEG” is selectable only when [A]Frame & Bit Rate] is set to “24p(UHQ)”, “24p(HQ)” or “25p(HQ)”.  
When [A]Frame & Bit Rate] is set to other values, the shutter display setting is fixed at “SEC” and cannot be selected.  
( P112 [ A Frame & Bit Rate ] )

# A/V Set Menu

Menu screen for video output and audio.

## Video Set...

For specifying video output-related settings.  
( P107 [Video Set Item])

## Audio Set...

For specifying audio-related settings.  
( P107 [Audio Set Item])

## Video Set Item

### Display On TV

For setting whether to display the display and menu characters on the external monitor.  
[Setting Values: On, ●Off]

### HDMI/SDI Out

For setting the terminal to output the video.  
[Setting Values: HDMI+SDI, SDI, HDMI, ●Off]

Memo : \_\_\_\_\_

- When [Network] is set to “On(SDI Off)”, videos will not be output to SDI. Also, setting to “On(HDMI Off)” disables the HDMI output.
- The selectable options vary according to the [Network] setting.

### ↳ Resolution

For selecting the resolution of video output from the [HDMI]/[SDI] terminal according to the monitor to be connected.

[Setting Values: 576i, 576p, 480i, 480p, 720p, ●1080i]

Memo : \_\_\_\_\_

- The selectable options vary according to the setting in [System]/[A]Resolution/[A]Frame & Bit Rate] of [System] → [Record Set] → [Record Format].
- Cross conversion output is not possible.

### ↳ HDMI Color

• For setting the color format of HDMI signals.  
• This item is selectable only when [HDMI/SDI Out] is set to “HDMI” or “HDMI+SDI”.

[Setting Values: RGB, ●Auto]

### ↳ HDMI Enhance

- For setting the color range of HDMI signals. When connecting to a PC monitor, set this to “On”.
- This item is selectable only when [HDMI/SDI Out] is set to “HDMI” or “HDMI+SDI”.

[Setting Values: On, ●Off]

### SD Aspect

For setting the style of displaying down-converted images on a 4:3 aspect ratio screen.

- Side Cut:  
Displays image with the left and right sides cut off.
- Letter:  
Displays as a wide image with the top and bottom blackened.
- Squeeze:  
Displays image that is squeezed horizontally.

[Setting Values: Side Cut, Letter, ●Squeeze]

Memo : \_\_\_\_\_

- When [Record Format] → [System] is set to “SD” or “HD+SD”, and when [SD Aspect] is set to “4:3”, this item appears as “---” and cannot be selected.  
( P111 [ System ])

### SD Set Up

For selecting whether to add a setup signal to the video signal output from the [AV] output terminal. Setup signals are added when “7.5%” is selected.  
[Setting Values: 7.5%, 0.0%]  
(Default values: 7.5% (U model), fixed at “0.0%” (E model))

Memo : \_\_\_\_\_

- Depending on the menu settings of the camera recorder and the condition of the cable connected to it, the setup signal setting may be fixed at “0.0%”. “0.0%” is displayed in gray in this case.

## Audio Set Item

### Input1 Mic Ref.

For setting the reference input level when the [INPUT1] selection switch is set to “MIC” or “MIC +48V”.

[Setting Values: -62dB, -56dB, ●-50dB, -44dB, -38dB]

**Input2 Mic Ref.**

For setting the reference input level when the [INPUT2] selection switch is set to "MIC" or "MIC +48V".

[Setting Values: -62dB, -56dB, ●-50dB, -44dB, -38dB]

**Int. Mic Gain**

For setting the sensitivity of the built-in microphone.

[Setting Values: +12dB, +6dB, ●0dB]

**AUX Gain**

For setting the sensitivity of the [AUX] terminal input.

[Setting Values: +12dB, +6dB, ●0dB]

**Ref. Level**

For setting the audio reference level to be recorded to the SD card. (Applies to both [CH1/CH2].)

[Setting Values: -12dB, -18dB, ●-20dB]

**Limiter**

For setting the limiter operation.

- Ref. Level:  
Sets "Ref. Level" to the maximum recording level.
- -8dBFS, -5dBFS:  
Sets "-8dBFS" or "-5dBFS" to the maximum recording level.
- Off:  
Depending on the settings of the [CH1/CH2 AUTO/MANUAL] selection switches, the operation may be different as described below.
  - The limiter does not function when "MANUAL" is set.
  - The limiter functions at -5 dBFS when "AUTO" is set.

[Setting Values: Ref. Level, -8dBFS, ●-5dBFS, Off]

**AGC Response**↳ **Attack Time**

Sets the time to activate the limiter.

[Setting Values: Fast, ●Middle, Slow]

↳ **Decay Time**

Sets the time to deactivate the limiter operation.

[Setting Values: Fast, ●Middle, Slow]

**AGC Mode**

For setting whether to link the limiter operation of [CH1] and [CH2].

Select "Link" to link or "Separate" to separate.

[Setting Values: Link, ●Separate]

Memo : \_\_\_\_\_

- Enabled only when both the [AUX] input terminal and [INPUT1/INPUT2] input terminal are set to "LINE" or "MIC", and CH1/CH2 of the [CH1/CH2 AUTO/MANUAL] switch is set to "AUTO".

**XLR Manual Level**

For setting whether to link manual audio adjustment operation between [INPUT1] and [INPUT2] terminals.

Select "Link" to link or "Separate" to separate.

When this item is set to "Link", adjust the recording level using the [CH1] recording level adjustment knob.

[Setting Values: Link, ●Separate]

Memo : \_\_\_\_\_

- Enabled only when both the [INPUT1/INPUT2] input terminals are set to "LINE" or "MIC", and both [CH1]/[CH2] of the [CH1/CH2 AUTO/MANUAL] selection switches are set to "MANUAL".
- When this item is set to "Link", [CH2] recording level adjustment knob is disabled.

**Int. Mic Separation**

For setting the enhancement level of the stereo effect of the built-in microphone.

- 1 to 4:  
Enhances the stereo effect. Increasing the value increases the stereo effect.
- Effect off:  
Does not enhance the stereo effect.
- Mono:  
Sets the built-in microphone to monaural.

[Setting Values: 1 to 4, Effect off, Mono (●2)]

Memo : \_\_\_\_\_

- When any value from 1 to 4 is selected, the sound quality changes slightly due to the process of enhancing the stereo effect. This is normal.
- This menu is enabled when the [CH1]/[CH2] selection switch is set to "INT".

## Test Tone

For specifying whether to output the audio test signals (1 kHz) during color bar output.

[Setting Values: On, ●Off]

## INPUT1/2 Wind Cut

For selecting whether to cut the low frequencies of the audio input signals (low-cut) when the [INPUT1/INPUT2] switch is set to "MIC" or "MIC+48V".

Set this item to reduce wind noise from the microphone.

- Both:  
Enables low-cut on both the [INPUT1] and [INPUT2] terminals.
- INPUT2:  
Enables low-cut on the audio of the [INPUT2] terminal only.
- INPUT1:  
Enables low-cut on the audio of the [INPUT1] terminal only.
- Off:  
Disables low-cut.

[Setting Values: Both, INPUT2, INPUT1, ●Off]

## Int. Mic Wind Cut

For selecting whether to cut the low frequencies of the audio input signals (low-cut) from the built-in microphone. Set this item to "On" to reduce wind noise from the microphone.

[Setting Values: On, ●Off]

## Equalizer

You can correct the characteristic and enhance the sound of the connected microphone using this equalizer setting.

For setting the audio frequency from a 5-band equalizer.

- Frequency:  
100Hz, 330Hz, 1kHz, 3.3kHz, 10kHz
- Variable level:  
± 6dB (1dB step)

Memo : \_\_\_\_\_

- Audio will be recorded in the characteristic set in the equalizer.
- Set all bands to "0dB" to bypass the equalizer.
- When the equalizer level is set to +side, the audio may be distorted. In this case, reduce the recording level in Manual mode.
- If the values of multiple frequencies are changed, the specified levels and the actual levels may be different due to interference between the frequency bands.
- This function is enabled only when both [INPUT1/2 Wind Cut] and [Int. Mic Wind Cut] are set to "Off".

## Monitor

For setting the audio sound of the [MONITOR] terminal to stereo or mixed sound when the [MONITOR] switch on the LCD monitor is set to "BOTH".

- Mix:  
Outputs mixed sound (mixed sound of CH1 and CH2) to both L and R.
- Stereo:  
Outputs stereo sound (outputs audio sound of CH1 to L, and CH2 to R).

[Setting Values: ●Mix, Stereo]

Memo : \_\_\_\_\_

- If both CH1 and CH2 are built-in microphones, stereo sound is output from the [MONITOR] terminal regardless of the [Monitor] setting.

## Alarm Level

For selecting whether to turn on the warning tone as well as setting the volume.

The warning tone is output from the monitor speaker or [MONITOR] terminal.

[Setting Values: ●High, Middle, Low, Off]

## Audio On FULL AUTO

For setting whether to enable Auto for audio when [FULL AUTO] is set to "ON".

- SW Set:  
Sets the audio recording mode following the [CH1/CH2 AUTO/MANUAL] selection switch setting.
- Auto:  
Sets audio recording mode to the forced auto mode.

[Setting Values: SW Set, ●Auto]

# System Menu

This menu screen allows system-related settings. For specifying recording settings, formatting and restoring of SD card, tally lamp settings, network settings, date/time, time zone, and other settings. It can also be used to reset the menu settings to their default values.

## Record Set...

For specifying recorded video-related settings.  
( P111 [Record Set Item] )

## Media

### ↳ Format Media

For formatting (initializing) an SD card. Select a card slot (A or B), select [Format] from [Cancel]/[Format], and press the Set button (●) to format (initialize) the card.  
( P41 [Formatting (Initializing) SD Cards] )

### ↳ Restore Media

For restoring an SD card. Select a card slot (A or B), and press the Set button (●) to restore the SD card.  
( P42 [Restoring the SD Card] )

Memo : \_\_\_\_\_

- This item appears only when the SD card needs to be restored. However, it is not selectable when recording in Camera mode and during Clip Review.

## Setup File

This allows you to save the menu settings as well as the performance results of shutter speed and AWB.

It is useful to save settings according to different shooting conditions.

### ↳ Load File...

Loads the settings.  
( P132 [Loading a Setup File] )

### ↳ Store File...

Saves the settings.  
( P131 [Saving Setup Files] )

### ↳ Delete File...

Deletes the configured file.  
( P133 [Deleting Setup Files] )

## Auto Power Off

For setting whether to turn off the power automatically when the camera recorder is not operated for more than 5 minutes when the battery is used. This function is valid only when the battery is used.

[Setting Values: On, ●Off]

Memo : \_\_\_\_\_

- When both the battery and AC adapter are connected, power from the AC adapter connection will be used. As such, this function will not have any effect.

## Tally Lamp

For specifying the illumination settings of the tally lamp during recording.

- On:  
Lights up only during recording.
- Off:  
Turns off the indicator.

[Setting Values: ●On, Off]

## GPS

For setting the GPS function to On or Off (power on/off).

[Setting Values: On, ●Off]

## Network

To use the network function, set this item to “On(SDI Off)” or “On(HDMI Off)”.

- On(SDI Off):  
Uses the network function. However, SDI output is disabled.
- On(HDMI Off):  
Uses the network function. However, HDMI output is disabled.
- Off:  
Does not use the network function.

[Setting Values: On(SDI Off), On(HDMI Off), ●Off]

Memo : \_\_\_\_\_

- Restriction applies to the following functions when you are using the network function.
  - SDI and HDMI cannot be output simultaneously.
  - [Variable Frame Rate] cannot be selected.
  - [Flash Band Correction] is fixed at “Off”.
  - [LCD + VF] is fixed at “Off”.

### ↳ Import Metadata

For importing metadata from the FTP server.

Memo : \_\_\_\_\_

- This option is not available when [Network] is set to “Off”.

### ↳ Settings...

For specifying network-related settings.

( P115 [Settings Item] )

Memo : \_\_\_\_\_

- This option is not available when [Network] is set to “Off”.

### Reset All

Resets all menu settings.

Memo : \_\_\_\_\_

- [Date/Time] and [Time Zone] cannot be reset. ( P111 [ Date/Time ] )  
( P111 [ Time Zone ] )
- This item is not selectable when recording in Camera mode, during Clip Review, and in Media mode.

### Date/Time

For setting the year, month, day, hour, and minute.

Memo : \_\_\_\_\_

- If the signal reception for GPS satellites allows date and time to be set based on the GPS information, you can set the time obtained from the GPS satellite by pressing the [FOCUS ASSIST/1] button.  
If information cannot be obtained from GPS satellites and date/time cannot be set, the [FOCUS ASSIST/1] button appears grayed out.
- The display order of the date (year, month, day) follows the setting in [Display Settings] → [Date Style]. However, the 24-hour format is used for the hour display regardless of the [Time Style] setting.  
( P106 [ Date Style ] )

### Time Zone

For setting the UTC time difference in units of 30 minutes.

[Setting Values: UTC-00:30-UTC-12:00, UTC, UTC+14:00-UTC+00:30 (in 30 min increments)]  
(Default values: UTC-05:00 (U model), UTC (E model))

Memo : \_\_\_\_\_

- If [Date/Time] is already set, the [Date/Time] item is automatically adjusted when [Time Zone] is altered.

### System Information

#### ↳ Version

Displays information on the firmware version.

#### ↳ Fan Hour

For displaying the usage time of the internal fan.

Memo : \_\_\_\_\_

- Under normal environment, dust will accumulate on the internal fan when the camera recorder is used over a long period. Dust may enter the camera recorder especially if it is used outdoors. This may affect the image and sound quality of the camera recorder. Check and replace the fan after every 9000 hours (suggested guideline).

#### ↳ Open Source License

Displays the license for the open source software used by this camera recorder.

## Record Set Item

### Record Format

After setting of all items in the [Record Format] menu is complete, select [Set] at the bottom of the screen to apply the new settings on the camera recorder and switch the record format. A “Please Wait...” message appears during switching.

#### ↳ System

For selecting a system definition.

- HD:  
Records in “HD” (high definition) quality
- SD:  
Records in “SD” (standard definition) quality

- **HD+SD:**  
Records in “HD” (high definition) for slot A, and in “SD” (standard definition) for slot B.
  - **HD+Web:**  
Records in “HD” (high definition) for slot A, and in low definition for slot B.
- [Setting Values: ●HD, SD, HD+SD, HD+Web]

Caution : \_\_\_\_\_

- The selectable options for the [A]Format], [A]Resolution], and [A]Frame & Bit Rate] settings vary depending on the setting of this item.

### ↳ [A] Format

For selecting the format of the file to be recorded to the SD card in slot A.

[Setting Values: ●QuickTime(MPEG2), MP4(MPEG2), MXF(MPEG2), AVCHD]

Memo : \_\_\_\_\_

- When System is set to “HD” or “SD”, the recording file format will be the same for both SD cards in slots A and B.
- When System is set to “SD”, this item is fixed at “QuickTime(H.264)”.

### ↳ [A] Resolution

For selecting the image size to be recorded to the SD card in slot A. (Horizontal x vertical)

The available options vary according to the [A]Format] and [System] settings.

- When MP4(MPEG2) or QuickTime(MPEG2) is selected:  
[Setting Values: ●1920x1080, 1440x1080, 1280x720]
- When QuickTime(H.264) or AVCHD is selected:  
Fixed at “1920x1080”
- When MXF(MPEG2) is selected:  
[Setting Values: ●1920x1080, 1440x1080]

Memo : \_\_\_\_\_

- When [System] is set to “HD” or “SD”, the recording definition will be the same for both SD cards in slots A and B.
- When [System] is set to “SD”, this item is fixed as follows.
  - U model: Fixed at “720x480”
  - E model: Fixed at “720x576”
- The selectable values of [A]Frame & Bit Rate] vary according to the setting of this item.

### ↳ [A] Frame & Bit Rate

For selecting the frame rate and encoding bit rate for recording to the SD card in slot A when [System] is set to “HD”, “HD+Web”, or “HD+SD”.

The available options vary according to the [System] and [A]Resolution] settings.

- When “1920x1080” ([A]Format] is set to “AVCHD”) is selected:  
[Setting Values: 60i(HQ), 50i(HQ), 60i(SP), 50i(SP)]  
(Default values: 60i(HQ) (U model), 50i(HQ) (E model))
- When “1920x1080” ([A]Format] is set to “QuickTime(H.264)”) is selected:  
[Setting Values: 60i(UHQ), 50i(UHQ), 24p(UHQ)] (Default values: 60i(UHQ) (U model), 50i(UHQ) (E model))
- When “1920x1080” ([A]Format] is set to other than “AVCHD” or “QuickTime(H.264)”) is selected:  
[Setting Values: 60i(HQ), 30p(HQ), 24p(HQ), 50i(HQ), 25p(HQ)]  
(Default values: 60i(HQ) (U model), 50i(HQ) (E model))
- When “1440x1080” is selected:  
[Setting Values: 60i(HQ), 50i(HQ), 60i(SP), 50i(SP)]  
(Default values: 60i(HQ) (U model), 50i(HQ) (E model))
- When “1280x720” is selected:  
[Setting Values: 60p(HQ), 30p(HQ), 24p(HQ), 50p(HQ), 25p(HQ), 60p(SP), 50p(SP)]  
(Default values: 60p(HQ) (U model), 50p(HQ) (E model))

Memo : \_\_\_\_\_

- When “HD+SD” is selected, [Frame & Bit Rate] cannot be selected.
  - U model:  
50i(HQ), 50i(SP), 50i(UHQ), 50p(SP), 25p(HQ)
  - E model:  
60i(HQ), 60i(SP), 60i(UHQ), 30p(HQ), 24p(HQ), 24p(UHQ)
- When [System] is set to “SD”, this item is fixed as follows for the different models.
  - U model: “60i”
  - E model: “50i”
- When [System] is set to “HD” or “SD”, the frame rate and encoding bit rate for recording to the SD cards in slots A and B will be the same.

## ↳ **B** Format

For selecting the format of the file to be recorded to the SD card in slot B when [System] is set to “HD+Web” or “HD+SD”.

This item is fixed at “QuickTime(H.264)”.

## ↳ **B** Resolution

For selecting the size of the image to be recorded to the SD card in slot B when [System] is set to “HD+Web” or “HD+SD”. (Horizontal x vertical)

Depending on the [System] settings, this item is fixed as follows.

- When HD+SD is selected:  
“720x480” (U model), “720x576” (E model)
- When HD+Web is selected:  
Fixed at “480x270”

Memo : \_\_\_\_\_

- When [System] is set to “HD” or “SD”, this item is fixed at the same value as [**A**Resolution].

## ↳ **B** Frame & Bit Rate

For selecting the frame rate and encoding bit rate of the image to be recorded to the SD card in slot B when [System] is set to “HD+Web” or “HD+SD”.

The options are fixed as follows according to the settings for [System] and [**A**Frame & Bit Rate].

- When HD+SD is selected:  
“60i” (U model), “50i” (E model)
- When HD+Web is selected:  
“30p”, “25p”, or “24p”

Memo : \_\_\_\_\_

- When [System] is set to “HD” or “SD”, this item is fixed at the same value as [**A**Frame & Bit Rate].

## ↳ **SD** Aspect

For setting the aspect ratio of the recorded image when [System] is set to “HD+SD” or “SD”.

[Setting Values: ●16:9, 4:3]

Memo : \_\_\_\_\_

- When [System] is set to “HD” or “HD+Web”, this item is fixed at “16:9”.

## Rec Mode

- For selecting the record mode for recording to the SD card.  
(☞ P78 [Special Recording] )
- The selectable options vary according to the [Record Format] menu settings.

Format	Frame & Bit Rate	Setting values
MP4 (MPEG2) QuickTime (MPEG2) MXF (MPEG2)	30p(HQ), 24p(HQ), 25p(HQ)	Normal, Pre Rec, Clip Continuous, Interval Rec, Frame Rec, Variable Frame
	60i(HQ), 50i(HQ), 60i(SP), 50i(SP), 60p(HQ), 60p(SP), 50p(HQ), 50p(SP)	Normal, Pre Rec, Clip Continuous, Interval Rec, Frame Rec
AVCHD	60i(HQ), 50i(HQ), 60i(SP), 50i(SP)	Normal, Pre Rec, Interval Rec, Frame Rec
QuickTime (H.264)	60i(UHQ) 50i(UHQ)	Normal, Pre Rec, Clip Continuous, Interval Rec, Frame Rec
	60i (U model) 50i (E model)	
	24p(UHQ)	Normal, Pre Rec, Clip Continuous, Interval Rec, Frame Rec, Variable Frame

Memo : \_\_\_\_\_

- When [Slot Mode] is set to “Backup”, this item is fixed at “Normal”.
- [Variable Frame Rate] is enabled when [**A**Resolution]/[**B**Resolution] is set to “1920x1080” or “1280x720”, and [**A**Frame & Bit Rate]/[**B**Frame & Bit Rate] is set to “30p(HQ)”, “24p(UHQ)”, “24p(HQ)” or “25p(HQ)”.

### ↳ Pre Rec Time

For setting the pre-recording time when [Rec Mode] is set to “Pre Rec”.

[Setting Values: ●5sec, 10sec, 15sec]

### ↳ Rec Frames

For setting the number of frames to record when [Rec Mode] is set to “Frame Rec” or “Interval Rec”.

[Setting Values: ●1frame, 3frames, 6frames]

### ↳ Rec Interval

For setting the recording time interval when [Rec Mode] is set to “Interval Rec”.

[Setting Values: ●1sec, 2sec, 5sec, 10sec, 30sec, 1min, 2min, 5min, 10min, 30min, 1hour]

### ↳ Variable Frame Rate

For setting the frame rate during recording when [Rec Mode] is set to “Variable Frame”.

The available options vary according to the settings for [Record Format] → [A]Resolution/

[B]Resolution] and [A]Frame & Bit Rate]/[B]Frame & Bit Rate].

(☞ P82 [Variable Frame Rec] )

### Slot Mode

For setting the operation of the card slot.

- Series:  
Mode that activates the two slots sequentially.
- Dual:  
Mode that activates the two slots at the same time.  
(☞ P74 [Dual Rec] )
- Backup:  
Mode that enables recording to slot B without using the [REC] button. This item is selectable only when [Rec Mode] is set to “Normal”.  
Start or stop the recording using the [Backup Rec] menu or press the [USER1] to [USER7], [LCD KEY▲], [LCD KEY▶], [LCD KEY▼], [LCD KEY◀] that is assigned with “Backup Trig”.  
(☞ P76 [Backup Rec] )

Memo : \_\_\_\_\_

- When this is set to “Series”, and recordable media are inserted in both slots, pressing the [REC] button starts recording only to the card in the selected slot (active slot).
- When “Series” is selected, and [Record Format] → [A]Format is set to “AVCHD”, the clips are recorded over the slots seamlessly without interruption in the video.
- When this is set to “Dual”, and recordable media are inserted in both slots, pressing the [REC] button starts simultaneous recording to the cards in both slots.

### ↳ Backup Rec

For starting/stopping backup recording with [REC]/[STBY].

This item is selectable only when [Slot Mode] is set to “Backup”.

Memo : \_\_\_\_\_

- When recording is stopped due to no remaining space on the media, etc., this item is fixed at “STOP” and cannot be selected.

## Time Stamp

For setting whether to display shooting date/time information in the recorded video.

[Setting Values: On, ●Off]

Memo : \_\_\_\_\_

- The date/time display style can be changed in [LCD/VF] → [Display Settings] → [Date Style]/[Time Style].  
(☞ P106 [ Date Style ] )  
(☞ P106 [ Time Style ] )
- When the date/time is hidden while the menu screen, status screen or other screen is displayed, the date/time during this period will not be recorded to the video. A confirmation screen appears if you try to display the menu screen or status screen during recording.
- When [System] is set to "HD+Web" or "HD+SD", the shooting date/time information cannot be recorded to the image to be recorded in slot B.

## Clip Set

### ↳ Clip Name Prefix

For setting the first four characters of the name of the clip file to be recorded to the SD card. Enter any of the 38 characters including alphabets (upper case), numbers (0 to 9), "\_" (underscore), and "-" (hyphen) using the software keyboard.

(☞ P93 [Text Input with Software Keyboard] )

[Setting Values: xxxG] (The default value of xxx is the last three digits of the serial number.)

Memo : \_\_\_\_\_

- When [Main Menu] → [System] → [Record Set] → [Record Format] → [AFormat] is set to "AVCHD", this setting is not reflected in the file name of the clip.  
However, it is recorded as the display name of the clip in the thumbnail display.

### ↳ Reset Clip Number

For assigning a new number (Clip Number) by resetting it (0001).

Select [Reset] and press the Set button (●) to reset the number.

When [AFormat] is set to "AVCHD", the clip number is reset to "00000".

When other clips exist on the SD card, the smallest available number is used after reset.

- Example:  
If the [Clip Name Prefix] is "ABCD", and "ABCD0001" already exists on the SD card, "ABCD0002" will be assigned.

## Settings Item

For specifying network-related settings.

The display of the software keyboard for input varies according to the item you are setting.

(☞ P93 [Text Input with Software Keyboard] )

### Web

For setting the functions that make use of the web browser.

#### ↳ Web Access

To access via a web browser, set to "On".

[Setting Values: ●On, Off]

#### ↳ Camera Name

For setting the name to be displayed on the web browser. Enter not more than 8 characters using the software keyboard.

(Default value: HM650)

#### ↳ Change Password

Changes the password for accessing via a web browser.

The current password is displayed. Enter a new password directly.

Enter not more than 31 characters using the software keyboard.

### Connection Setup

For configuring the network connection settings. Configure the settings by following the instructions on the [Wizard] screen that is displayed according to the type of adapter that is connected to the rear [HOST] terminal.

You can Store, Load, or Delete the settings you have specified on the [Wizard] screen.

#### ↳ Wizard

A [Wizard] screen appears according to the type of adapter that is connected to the rear [HOST] terminal.

Follow the instructions.

#### ↳ Load

Loads the settings on the [Wizard] screen.

(☞ P157 [Reading the Connection Settings File] )

#### ↳ Store

Saves the settings on the [Wizard] screen.

(☞ P156 [Saving the Connection Settings File] )

#### ↳ Delete

Deletes the saved settings.

(☞ P158 [Deleting Connection Settings] )

## Metadata Server

For registering the FTP server for importing the metadata and the path of the file to be imported. Up to 4 settings can be registered.

### ↳ Meta-FTP1 to Meta-FTP4 (The name specified in the respective [Alias] items is displayed)

#### ■ Alias

For setting a name to distinguish the settings of this camera recorder.

The name set in this item will be displayed in the [Import Metadata] options.

\* Enter not more than 31 characters.

#### ■ Server

For setting the server name (“mystation.com”, etc.) or the IP address (“192.168.0.1”, etc.) of the FTP server.

\* Enter not more than 127 characters using single-byte alphanumeric characters (a to z, 0 to 9), single-byte hyphen [-], or dot [.].

#### ■ Port

Enter the FTP server port number to use using an integer between 1 and 65535.

(Default value: 21)

#### ■ File Path

Enter the path name for the metadata file (“/pub/meta.xml”, “/home/user/meta2.xml”, etc.)

\* Enter not more than 127 characters.

#### ■ Username

Enter the user name for connecting to the FTP server.

\* Enter not more than 31 characters.

#### ■ Password

Enter the password for connecting to the FTP server.

\* Enter not more than 31 characters.

#### ■ PASV Mode

For setting whether to set the communication mode used for file transfer to the passive mode.

Set to “On” if the camera is inside a firewall, and a connection from the FTP server to the camera cannot be established.

[Setting Values: On, ●Off]

## Clip Server

For setting the server and directory for uploading recorded clips in the SD card to the FTP server.

### ↳ Clip-FTP1 to Clip-FTP4 (The name specified in the respective [Alias] items is displayed)

#### ■ Alias

For setting a name to distinguish the settings of this camera recorder.

The name set in this item will appear on the [FTP Upload] action screen of the thumbnail display.

\* Enter not more than 31 characters.

#### ■ Server

For setting the server name (“mystation.com”, etc.) or the IP address (“192.168.0.1”, etc.) of the FTP server.

\* Enter not more than 127 characters using single-byte alphanumeric characters (a to z, 0 to 9), single-byte hyphen [-], or dot [.].

#### ■ Port

Enter the FTP server port number to use using an integer between 1 and 65535.

(Default value: 21)

#### ■ Dir. Path

Enter the path name for the directory to upload to (“/pub”, “/home/user”, etc.)

\* Enter not more than 127 characters.

#### ■ Username

Enter the user name for connecting to the FTP server.

\* Enter not more than 31 characters.

#### ■ Password

Enter the password for connecting to the FTP server.

\* Enter not more than 31 characters.

#### ■ PASV Mode

For setting whether to set the communication mode used for file transfer to the passive mode.

Set to “On” if the camera is inside a firewall, and a connection from the FTP server to the camera cannot be established.

[Setting Values: On, ●Off]

## Reset Network

Restores all items in the [Network] menu to their default settings.

# Adding/Editing Frequently Used Menu Items (Favorites Menu)

You can select and add/edit frequently used menu items freely to create a personal menu screen (Favorites Menu).

Memo : \_\_\_\_\_

- [Favorites Menu] is only enabled in the Camera mode. [Favorites Menu] remains unchanged even when the recording format changes.
- Up to 20 menu items can be added.
- Added items in [Favorites Menu] will not be reset even when [Main Menu] → [Reset All] is executed.
- Long descriptive names may be displayed for the menu items in [Favorites Menu] to enable better understanding.

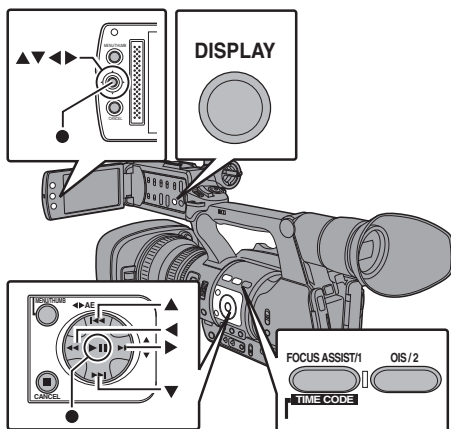

## Adding Menu Items to Favorites Menu

- 1 Press the [MENU] button to open the [Main Menu] screen.
- 2 Select the menu or submenu item to add.

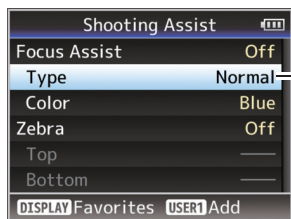

Memo : \_\_\_\_\_

- Adding items to [Favorites Menu] cannot be performed in the following cases. [USER1 Add] is displayed in gray in the operation guide.
  - Selected item is already added to [Favorites Menu].
  - Number of menu items that can be added (20 items) is exceeded.

- 3 Press the [FOCUS ASSIST/1] button. A screen to confirm the addition appears.
- 4 Select [Add] and press the Set button (●). The selected menu item is added to [Favorites Menu].

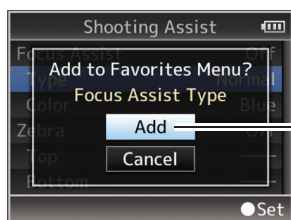

## Editing Favorites Menu

You can delete or change the order of the items added to [Favorites Menu].

### Deleting Items from [Favorites Menu]

#### 1 Open the [Favorites Menu] screen.

- ① Press the [MENU] button to open the [Main Menu] screen.
- ② Press the [DISPLAY] button to open the [Favorites Menu] screen.

#### 2 Select [Edit Favorites] and press the Set button (●) or crossed-shaped button (▶).

The header turns magenta and the editing mode is activated.

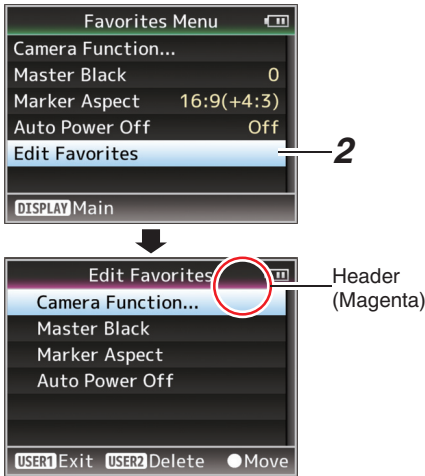

#### 3 Select the menu or submenu item to delete.

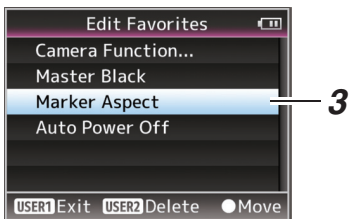

#### 4 Press the [OIS/2] button.

A delete mark (X) appears at the beginning of the menu item.

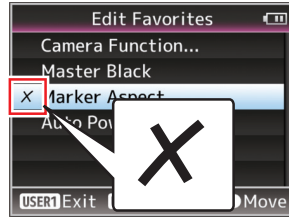

Memo : \_\_\_\_\_

- When the [OIS/2] button is pressed again while the menu item with the delete mark (X) is selected, the menu item will be excluded from the items to be deleted and the delete mark (X) disappears.

#### 5 Press the [FOCUS ASSIST/1] button.

The option menu to exit the [Favorites Menu] editing mode appears.

#### 6 Select [Save & Exit] and press the Set button (●).

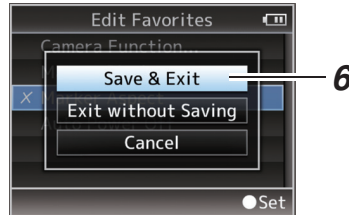

Memo : \_\_\_\_\_

- Deletion is not complete until the changes are saved with [Save & Exit].
- To exit the editing mode without deleting any items, select [Exit without Saving].
- To return to the editing mode, select [Cancel].

## Changing the Order of Items in [Favorites Menu]

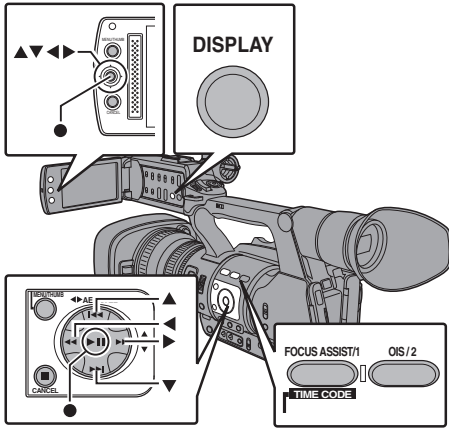

- 1 Open the [Favorites Menu] screen.**  
Press the [MENU] button to open the [Favorites Menu] screen.
- 2 Select [Edit Favorites] and press the Set button (●) or crossed-shaped button (▲▼).**  
The header turns magenta and the editing mode is activated.

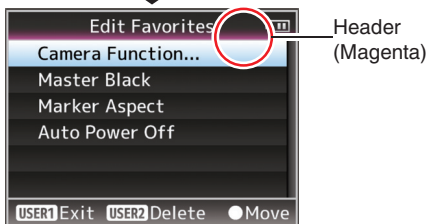
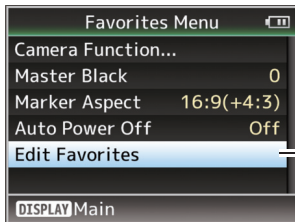

- 3 Select the menu or submenu item to move and press the Set button (●).**

The moving mode is activated and a position selection bar for the move appears.

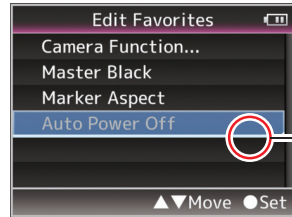
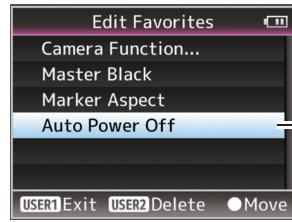

- 4 Select the position to move to with the cross-shaped button (▲▼).**  
Move the position selection bar with the cross-shaped button (▲▼) and select a position to move to.
- 5 Press the Set button (●).**  
The selected item moves to the new position.

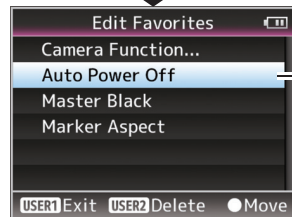

- 6 Press the [FOCUS ASSIST/1] button.  
The option menu to exit the [Favorites Menu] editing mode appears.
- 7 Select [Save & Exit] and press the Set button (●).

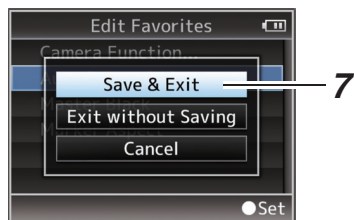

Memo : \_\_\_\_\_

- Moving is not complete until the changes are saved with [Save & Exit].
  - To exit the editing mode without saving any changes, select [Exit without Saving].
  - To return to the editing mode, select [Cancel].
- \_\_\_\_\_

# Display Screen in Camera Mode

## Display 0 screen

This screen displays the event. It is also used to display warnings only.

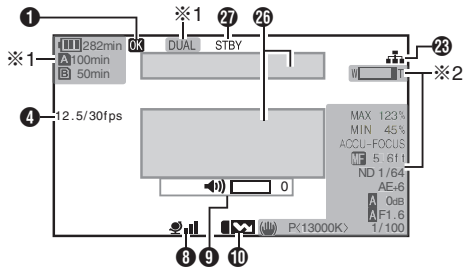

- \*1 Appears only during warnings
- \*2 Appears only during operation

## Display 1 screen

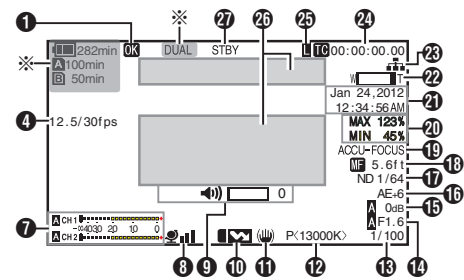

- \* Appears only during warnings

## Display 2 screen

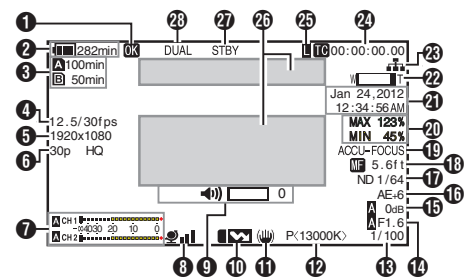

- ① OK Mark  
Displayed when OK mark has been appended.  
(☞ P88 [Appending/Deleting OK Mark])
- ② Voltage/Battery Power  
Displays the current status of the power supply in use.  
(☞ P30 [Power Status Display])

Memo : \_\_\_\_\_

- Displayed in the Display 0 and Display 1 screens during warnings only.

- ③ Remaining Space on Media  
Displays the remaining recording time of the SD cards in slot A and slot B separately.

- Ⓐ : Currently selected slot. (White card)
- Ⓐ : Write-protect switch of SD card is set.
- Ⓐ!INVALID : SD card cannot be read or written to, or restored.
- Ⓐ!FORMAT : SD card requires formatting.
- Ⓐ!RESTORE : SD card requires restoring.
- Ⓐ!INCORRECT : When [Rec Mode] is set to other than "AVCHD"/"SD" with a Class 4 SD card inserted.  
Or when the SD card is not supported.
- Ⓐ!REC INH : When attempting to record in 50i(HQ)/50i(SP) to an SD card recorded in [AVCHD] 60i(HQ)/60i(SP) (or vice versa).

Memo : \_\_\_\_\_

- This item is not displayed when [Main Menu] → [LCD/VF] → [Display Settings] → [Media Remain] is set to "Off". However, warnings will be displayed.  
(☞ P106 [Media Remain])
- Displayed in the Display 0 and Display 1 screens during warnings only. (When the remaining time is shorter than 3 minutes)
- The displayed time is an estimate.

- ④ Frame rate  
Displayed as xx/yy fps (xx: recording frame rate, yy: playback frame rate) only when [Rec Mode] is set to "Variable Frame".  
(☞ P113 [Rec Mode])

**5** Resolution

Displays the video image resolution.

Memo : \_\_\_\_\_

- This item is not displayed when [Main Menu] → [LCD/VF] → [Display Settings] → [Record Format] is set to “Off”.  
(☞ P105 [ Record Format ] )

**6** Frame Rate/Bit Rate

Displays the frame rate and bit rate in pairs.

Memo : \_\_\_\_\_

- This item is not displayed when [Main Menu] → [LCD/VF] → [Display Settings] → [Record Format] is set to “Off”.  
(☞ P105 [ Record Format ] )

**7** Audio Level Meter

- Displays the audio levels of CH1 and CH2.
- **A** appears on the screen when in the Auto mode.



- When [Rec Mode] → [Rec Mode] is set to “Frame Rec”, “Interval Rec”, or “Variable Frame”, audio cannot be recorded and is indicated by the mark.



Memo : \_\_\_\_\_

- This item is not displayed when [Main Menu] → [LCD/VF] → [Display Settings] → [Audio Meter] is set to “Off”.  
(☞ P106 [ Audio Meter ] )

**8** GPS Mark

When [Main Menu] → [System] → [GPS] is set to “On”, the signal reception status is displayed.

(☞ P110 [ GPS ] )

Memo : \_\_\_\_\_

- The display changes according to the signal reception sensitivity. If signals cannot be received, the mark appears in yellow.
- This item is not displayed when [GPS] is set to “Off”.

**9** Volume Operation Indicator

Displayed when there are changes made to the volume of the headphone, speaker (0 to 15), and the values of LCD BRIGHT, PEAKING (-10 to +10).

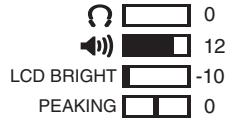

Memo : \_\_\_\_\_

- There is no audio output from the speaker in Camera mode.

**10** Flash Band Correction Mark

This item is displayed when [Main Menu] → [Camera Function] → [Flash Band Correction] is set to “On”.

(☞ P95 [ Flash Band Correction ] )

**11** Image Stabilizer Mark

Displayed when the image stabilizer is ON.

- : When [Level] of [OIS] is set to “Normal”.
- : When [Level] of [OIS] is set to “High”.

Memo : \_\_\_\_\_

- If image stabilizer is set to “OFF” when the Display 0 screen is displayed, appears for 3 seconds.
- Displayed in the Display 0 screen only when there is a change.

**12** White Balance Mode

Displays the current white balance mode.  
(\*\*\*\*\*K indicates color temperature)

- A<\*\*\*\*\*K> : When the white balance is set to Auto A.
- B<\*\*\*\*\*K> : When the white balance is set to Auto B.
- P<\*\*\*\*\*K> : When the white balance is set to Preset.
- A** <FAW> : During Full Auto White Balance mode.
- L** <FAW> : When [AE LOCK] is set to “On” during Full Auto White Balance mode.

Memo : \_\_\_\_\_

- Displayed in the Display 0 screen only when there is a change.

**13** Shutter

- The current shutter speed is displayed when the shutter is set to “On”.

(☞ P95 [ Shutter ] )

- **A** is displayed when the [FULL AUTO] switch is set to “ON” to enable Full Auto shooting mode, or when the [SHUTTER] button is pressed to enable automatic shutter mode.

Memo : \_\_\_\_\_

- The variable range of the shutter speed varies according to the video format settings.  
(☞ P54 [Setting the Electronic Shutter] )
- Displayed in the Display 0 screen only when there is a change.
- If the shutter speed is not displayed, the shutter is OFF.

**14** Iris F-Number

Displays F-number of the lens iris.

**15** Gain

- Displays the gain value.
- **A** is displayed in the ALC mode during Manual shooting.
- **L** is displayed when AE LOCK is set to “ON”.
- “LUX30” or “LUX36” is displayed when in the low-light shooting mode.

Memo : \_\_\_\_\_

- Displayed in the Display 0 screen only when there is a change.

**16** AE Level

- Appears when the AE function is activated, and [Main Menu] → [Camera Function] → [AE Level] is set to a value other than “Normal”.

(☞ P95 [ AE Level ] )

- When operated while manual operation is disabled, “AE” blinks for about 5 seconds.
- When face detection is enabled and [Face Detect] is set to “AF&AE”, **AE** appears on the left side of “AE”.

(☞ P50 [Adjusting the Focusing by Face Detection] )

**17** ND Filter Position

Displays the current ND filter position.

Memo : \_\_\_\_\_

- This item is not displayed when [Main Menu] → [LCD/VF] → [Display Settings] → [ND Filter] is set to “Off”.

(☞ P105 [ ND Filter ] )

- Displayed in the Display 0 screen only when there is a change.

**18** Focus Display

- Displays the value of the focal length during manual focus.
- **AF** is displayed during Auto Focus.
- When face detection is enabled, **AF** appears on the left side of **AF**.

(☞ P50 [Adjusting the Focusing by Face Detection] )

(☞ P97 [ Face Detect ] )

Memo : \_\_\_\_\_

- You can specify whether to display the focus value (“Feet”/“Meter”) or turn off the display in [Main Menu] → [LCD/VF] → [Display Settings] → [Focus].

This item will not be displayed when “Off” is selected.

(☞ P105 [ Focus ] )

- Displayed in the Display 0 screen only when there is a change.

**19** Focus Assist

- “FOCUS” is displayed when auto focus is activated.
- When ACCU-Focus is enabled, “ACCU-FOCUS” blinks for about 10 seconds while Focus Assist starts up, after which the “FOCUS” indicator lights up.
- If recording starts while [ACCU-Focus] is active, [ACCU-Focus] will be forcibly deactivated.

(☞ P104 [ Focus Assist ] )

Memo : \_\_\_\_\_

- Displayed in the Display 0 screen only when there is a change.

**20** Luminance Information

Displayed when the Spot Meter function is activated.

(☞ P70 [Setting Spot Meter] )

MAX : Maximum luminance

MIN : Minimum luminance

- 21** Date/Time Display  
Displays the current date and time.

Memo : \_\_\_\_\_





- The date/time display style can be specified in [Main Menu] → [LCD/VF] → [Display Settings] → [Date Style]/[Time Style].  
(☞ P106 [ Date Style ] )  
(☞ P106 [ Time Style ] )
- This item is not displayed when [Main Menu] → [LCD/VF] → [Display Settings] → [Date/Time] is set to “Off”.  
(☞ P106 [ Date/Time ] )
- When [Main Menu] → [System] → [Record Set] → [Time Stamp] is set to “On”, this item is not displayed.  
(☞ P115 [ Time Stamp ] )

- 22** Zoom Display
- Displays the zoom position. (Zoom bar or value)
  - The zoom bar will only be displayed for 3 seconds after the zoom operation is activated.
  - The value will always be displayed. (0 to 99)

Memo : \_\_\_\_\_

- You can specify the display method (Number/Bar) and whether to turn off the display in [LCD/VF] → [Display Settings] → “Zoom”. This item will not be displayed when “Off” is selected.  
(☞ P105 [ Zoom ] )
- Displayed in the Display 0 screen only when there is a change.

- 23** Network Connection Icon
- When [Main Menu] → [System] → [Network] is set to “On”, the network connection status is displayed. This icon is not displayed when “Off” is selected.

Icon	Status
 (Blink)	Connection is not established (starting up, preparing for connection)
 (Yellow)	Connection is not established (preparing for connection)
	Connection is established
	When a USB adapter different from the connection settings is detected
(No display)	When an incompatible USB adapter is detected, or when [Network] is set to “Off”

- 24** Time Code (TC)/User’s Bit (UB) Display
- Displays the time code (hour: minute: second: frame) or user’s bit data.
  - Example of time code display:

**TC00:00:00**  
↓  
※

\* Colon (:) denotes non-drop frames and dot (.) denotes drop frames.

- Example of user’s bit display:

**UBFF EE DD 20**

Memo : \_\_\_\_\_

- You can specify whether to display the time code, user’s bit, or turn off the display in [LCD/VF] → [Display Settings] → [TC/UB]. This item will not be displayed when “Off” is selected.  
(☞ P106 [ TC/UB ] )

- 25** Time Code Lock Indicator
- When the built-in time code generator is synchronized to the external time code data input during the synchronization of time code with another camera recorder,  lights up.  
(☞ P68 [Synchronizing Time Code on Another Camera] )

- 26** Event/Warning Display Area
- Displays error messages.  
(☞ P159 [Error Messages and Actions] )

- 77** Media Status
- : No card found in the selected slot
- STBY : Recording standby
- REC : Recording
- REVIEW : Clip Review  
(☞ P72 [Viewing Recorded Videos Immediately (Clip Review)])
- STBY **P** : Pre Rec recording standby  
(☞ P78 [Pre Rec])
- REC **P** : Pre Rec recording  
(☞ P78 [Pre Rec])
- STBY **C** : Clip Continuous Rec recording standby  
(☞ P78 [Clip Continuous Rec])
- REC **C** : Clip Continuous Rec recording  
(☞ P78 [Clip Continuous Rec])
- STBY **C** : Clip Continuous Rec recording (displayed in pause yellow)  
(☞ P78 [Clip Continuous Rec])
- STBY **I** : Interval Rec recording standby  
(☞ P81 [Interval Rec])
- STBY **I** : Interval recording pause (displayed in red)
- REC **I** : Interval Rec recording  
(☞ P81 [Interval Rec])
- STBY **F** : Frame Rec recording standby  
(☞ P80 [Frame Rec])
- REC **F** : Frame Rec recording  
(☞ P80 [Frame Rec])
- STBY **F** : Frame Rec recording pause (displayed in yellow)  
(☞ P80 [Frame Rec])
- STOP : Unable to record to the card in the slot
- P.OFF : Power OFF

- 28** Dual Rec/Backup Rec Display
- “DUAL” is displayed in the Dual Rec mode and “BACKUP” is displayed in the Backup Rec mode.  
(☞ P114 [ Slot Mode ] )

- Memo : \_\_\_\_\_
- This item is not displayed when [Slot Mode] is set to “Series”.
  - This item is not displayed when [Main Menu] → [LCD/VF] → [Display Settings] → [Media Remain] is set to “Off”. However, warnings will be displayed.  
(☞ P106 [ Media Remain ] )
  - Displayed in the Display 0 and Display 1 screens during warnings only. (When the remaining time is shorter than 3 minutes)

# Display Screen in Media Mode

## Media Display 0 Screen

This screen displays the media status or event. It is also used to display warnings only.

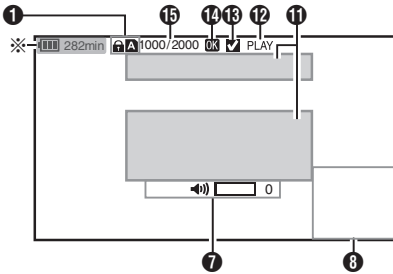

\* Appears only during warnings

## Media Display 1 Screen

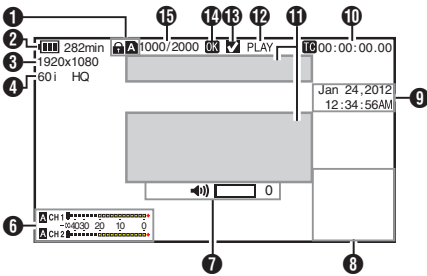

- 1 Media
  - Displays the media slot (A or B) of the currently played clip.
  - appears when the write-protect switch of the SD card is set.

- 2 Voltage/Battery Power
  - Displays the current status of the power supply in use.
  - ( P30 [Power Status Display])

Memo : \_\_\_\_\_  
 • Displayed in the Media Display 0 screen during warnings only.

- 3 Resolution
  - Displays the video image resolution.
- 4 Frame Rate/Bit Rate
  - Displays the frame rate and bit rate in pairs.
- 5 Operation Guide
  - Displays a guide for the current operation buttons.

- 6 Audio Level Meter
  - Displays the audio levels of CH1 and CH2.



Memo : \_\_\_\_\_  
 • This item is not displayed when [Main Menu] → [LCD/VF] → [Display Settings] → [Audio Meter] is set to "Off".  
 ( P106 [ Audio Meter ] )

- 7 Volume Operation Indicator
  - Displayed when there are changes made to the volume of the headphone, speaker (0 to 15), and the value of LCD BRIGHT (-10 to +10).
  - The [PEAKING +/-] operation is disabled in the Media mode, and its value is fixed at "-10".  
 ( P122 [Volume Operation Indicator])

## Media Display 2 Screen

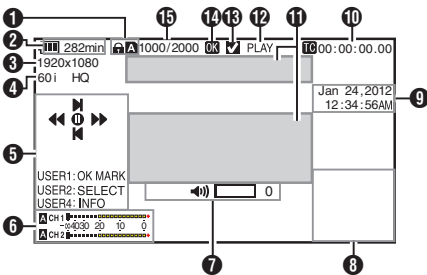

- 8** Information Display  
Use the [AE LOCK/4] button to switch between camera information display, GPS display and turning off the display.
- The GPS display displays information on the recording location of the video being played back only when GPS information has been recorded. The local date/time is displayed.
  - Camera information display displays only information of Gain, Iris, Shutter and White Balance that have been recorded.

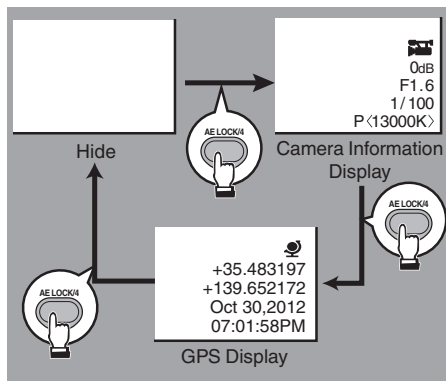

- 9** Date/Time Display  
Displays the date/time that is recorded on the currently played SD card.

Memo : \_\_\_\_\_

- The date/time display style can be specified in [LCD/VF] → [Display Settings] → [Date Style]/[Time Style].  
(☞ P106 [ Date Style ])  
(☞ P106 [ Time Style ])

- 10** Time Code (TC)/User's Bit (UB) Display
- Displays the time code (hour: minute: second: frame) or user's bit data.
  - Example of time code display:

TC00:00:00:00  
※

\* Colon (: ) denotes non-drop frames and dot (.) denotes drop frames.

- Example of user's bit display:

UBFF EE DD 20

Memo : \_\_\_\_\_

- You can specify whether to display the time code, user's bit, or turn off the display in [TC/UB] of [Main Menu] → [LCD/VF] → [Display Settings].

(☞ P106 [ TC/UB ])

- 11** Event/Warning Display Area  
Displays error messages.  
(☞ P159 [Error Messages and Actions])

**12** Media Status

PLAY	: Playing
STILL	: Still picture playback mode
FWD *	: High-speed playback in the forward direction (* playback speed: 5x or 15x)
REV *	: High-speed playback in the reverse direction (* reverse playback speed: 5x or 15x)
STOP	: Stop mode
P.OFF	: Power OFF

- 13** Check Mark  
Displayed when the currently played clip is selected.

- 14** OK Mark  
Displayed when OK mark has been appended.  
(☞ P88 [Appending/Deleting OK Mark])

- 15** Clip Information  
Displays current clip number/total number of clips.

# Status Screen

For checking the settings of the camera recorder.

## Camera 1 Screen/Camera 2 Screen

For checking information related to shooting using the camera recorder.

Camera 1	
Zebra	70%~80%
Marker Aspect	16:9
Safety Zone	90%
<b>A</b> Format	QuickTime(MPEG2) 1920x1080 60i(HQ)
<b>B</b> Format	QuickTime(H.264) 720x480 60i 16:9

Camera 2	
Shooting Mode	Standard
GAIN L	0 dB
GAIN M	6 dB
GAIN H	12 dB
AE LEVEL SW	AE LEVEL
Handle Zoom Speed	5
AF Assist	Off

## USER Switch Set Screen

For checking the status (functions assigned) of the user buttons.

(☞ P38 [Assigning Functions to User Buttons] )

USER Switch Set	
USER1	Focus Assist
USER2	OIS
USER3	Lolux
USER4	AE Lock
USER5	Zebra
USER6	Marker
USER7	Clip Review

## Audio Screen

For checking the settings related to audio input.

(☞ P107 [Audio Set Item] )

Audio	
Wind Cut	
MIC	-62 dB
<b>INPUT1</b>	→ CH1
<b>INPUT2</b>	→ CH2
MIC	-44 dB

## Audio Level Screen

For checking audio related information such as microphone volume level.

(☞ P61 [Audio Recording] )



## Video Screen

For checking the settings related to video output.

(☞ P107 [Video Set Item] )

Video	
HDMI/SDI Out	SDI
Resolution	1080i
HDMI Color	Auto
HDMI Enhance	Off
SD Aspect	Squeeze
SD Set Up	0.0%

## Network Screen

For checking the network-related settings.

(☞ P115 [ Wizard ] )

Network	
Type	P2P
SSID	HM650- [Signal]
Security Type	WPA2
Passphrase	[Signal]
IP Address	192.168.0.1
MAC Address	[Signal]

## Marker and Safety Zone Displays (Camera Mode Only)

The marker and safety zone displays are useful in helping you determine the angle of view for the image according to the shooting purpose.

- Example of display when [Aspect Ratio] = "4:3", [Aspect Marker] = "Line+Halftone", and [Center Mark] = "On"

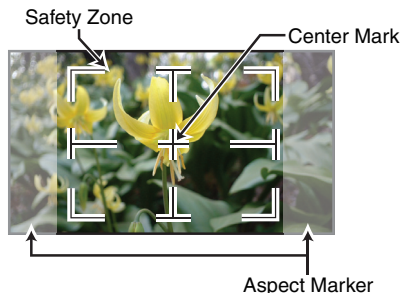

Memo : \_\_\_\_\_

- You can turn On/Off the safety zone and center mark displays using [LCD/VF] → [Marker Settings] → [Aspect Ratio], [Safety Zone], and [Center Mark].  
(☞ P105 [ Safety Zone ] )

## Smoothing the Skin Color (Skin Detail Function)

The Skin Detail function can be used to reduce the contour enhancement of video signals for only the skin areas so as to produce a smoother skin tone.

- 1 Set [Skin Detail] to "On".  
(☞ P101 [ Skin Detail ] )  
Set [Main Menu] → [Camera Process] → [Detail]/[Adjust] → [Skin Detail] to "On".

Memo : \_\_\_\_\_

- You can specify the adjustment level for the contour enhancement of the skin tone in [Main Menu] → [Camera Process] → [Detail]/[Adjust] → [Skin Detail]/[Level].  
(☞ P101 [ Level ] )

## Color Bar Output

Color bars can be output on this camera recorder.

Memo : \_\_\_\_\_

- The audio test signals (1 kHz) can be output simultaneously with the color bar output.  
(☞ P109 [ Test Tone ] )

### To Output the Color Bar Using the Menu

To output color bars, follow the setting procedure below.

- 1 Set [Camera Function] → [Bars] to "On".  
(☞ P95 [ Bars ] )  
Color bars are output.

### To Output the Color Bar Using the User Button

- 1 Assign the "Bars" function to any of the user buttons.  
(☞ P38 [Assigning Functions to User Buttons] )
- 2 Press the user button that is assigned with "Bars".  
Color bars are output.

# Adjusting Color Matrix

- The color matrix of the camera recorder can be adjusted to a color of the user's preference.
- When shooting is performed using multiple cameras, the colors of the different cameras can be adjusted, and a color of the user's preference can be set on this camera recorder.
- The Saturation, Hue and Lightness of the primary and complementary colors (6 colors in total) can be set individually.
- Adjust the color on the vector scope and waveform monitor using the DSC color chart.

\* The adjusted values of "Standard", "Cinema Vivid", and "Cinema Subdued" in [Color Matrix] can be stored individually.  
( P100 [ Color Matrix ] )

## 1 Select [Camera Process] → [Color Matrix]/ [Adjust].

( P100 [ Adjust ] )

## 2 Adjust Hue.

- Select the color using the cross-shaped button (▲▼) and confirm using the cross-shaped button (▶). (The cursor moves to Hue.)
- Pressing the cross-shaped button (▲) rotates the hue in the clockwise direction on the vector scope.
- Pressing the cross-shaped button (▼) rotates the hue in the anti-clockwise direction on the vector scope.

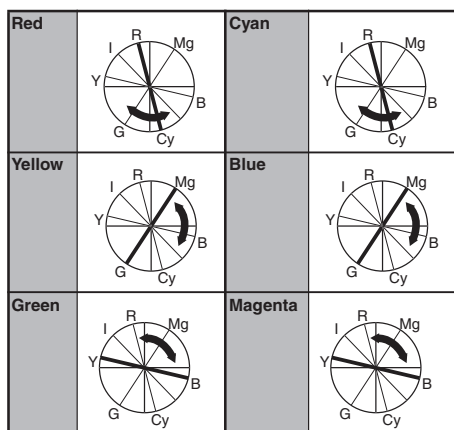

## 3 Adjust Saturation.

- Press the cross-shaped button (▶) to move the cursor to Saturation.
- Each of the colors changes in the direction indicated by the arrow on the vector scope.
- Pressing the cross-shaped button (▲) moves the color outward from the center of the circle on the vector scope.
- Pressing the cross-shaped button (▼) moves the color toward to the center of the circle on the vector scope.

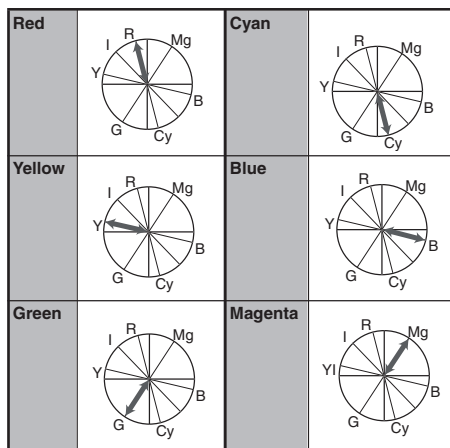

## 4 Adjust Lightness.

- Pressing the cross-shaped button (▲) lightens; and pressing the cross-shaped button (▼) darkens.
- Press the cross-shaped button (▶) to return the cursor to Hue.

# Configuring Setup Files

The menu settings can be stored on the camera recorder or an SD card by saving them as a setup file.

Loading a saved setup file enables you to reproduce the appropriate setup state speedily. Two types of setup files are available.

## ■ Scene file:

File that contains all menu settings, ranging from video format settings to image creation settings such as device settings and shooting conditions, as well as the contents of the [Favorites Menu].

## ■ Picture file:

File that contains image creation settings in accordance to the shooting conditions ([Camera Process] menu items).

( P98 [Camera Process Menu] )

Memo : \_\_\_\_\_

- Make use of the [Setup File] menu to save or load a setup file.
- The following operations can be performed on the [Setup File] menu.
  - [Saving Setup Files] P 131
  - [Loading a Setup File] P 132
  - [Deleting Setup Files] P 133

## Number of Storable Setup Files

Camera recorder : [CAM1] to [CAM4]  
SD slot A : [A 1] to [A 8]  
SD slot B : [B 1] to [B 8]

## Compatibility

### ■ Scene file

- Only scene files of the GY-HM600 and GY-HM650 series can be loaded.
- When the scene files saved using GY-HM650 are loaded, the functions that only exist on GY-HM650 are ignored.

### ■ Picture file

Only picture files of the GY-HM600 and GY-HM650 series can be loaded.

# | Saving Setup Files

## 1 Display the [Setup File] menu.

Select [Main Menu] → [System] → [Setup File] and press the Set button (●).  
( P110 [ Setup File ] )

## 2 Select [Store File] and press the Set button (●).

## 3 Select [Scene File] or [Picture File], and press the Set button (●).

The existing files are displayed.

## 4 Select the file to be newly saved (or overwritten) using the cross-shaped button (▲▼), and press the Set button (●).

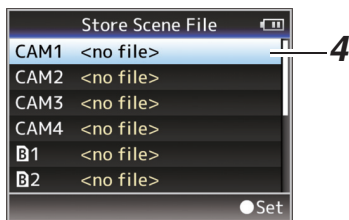

Memo : \_\_\_\_\_

- Files cannot be written in the following cases. (Displayed in gray, selection disabled)
  - When the inserted SD card is not supported or not formatted. (File name appears as “---”).
  - When a write-protected SD card is inserted (a mark appears beside the SD card icon).

## 5 Name the file.

- Enter the surname using the software keyboard.  
( P93 [Text Input with Software Keyboard] )
  - You can enter up to 8 characters for the [Store File]/[Picture File] surname.

Memo : \_\_\_\_\_

- When overwriting an existing file, the surname of the existing file is displayed.
- Select [Cancel] and press the Set button (●), or press the [CANCEL] button to return to the previous screen.

## 6 Select [Store] and press the Set button (●).



## 7 Save the file.

- A confirmation screen appears when you choose to overwrite. Select [Overwrite] on the confirmation screen, and press the Set button (●). Saving starts, and “Storing...” appears on the screen.

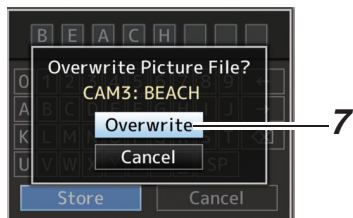

- Saving starts, and “Storing...” appears on the screen when the file is newly saved.

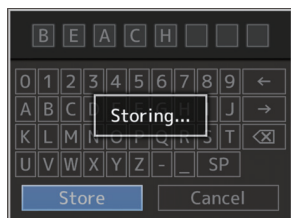

## 8 Saving is complete.

After saving of the file is complete, “Complete” appears on the screen, and the menu screen closes automatically.

## Loading a Setup File

### 1 Display the [Setup File] menu.

Select [Main Menu] → [System] → [Setup File] and press the Set button (●).  
(☞ P110 [ Setup File ])

### 2 Select [Load File] and press the Set button (●).

### 3 Select [Scene File] or [Picture File], and press the Set button (●).

The existing files are displayed.

### 4 Select the file to load using the cross-shaped button (▲▼), and press the Set button (●).

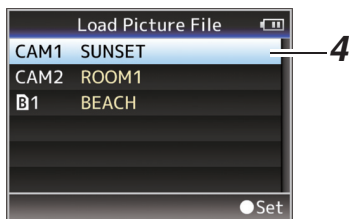

Memo :

- When the write-protect switch of the inserted SD card is set, a lock mark appears beside the SD card icon. Setup files can be loaded from an SD card even if the write-protect switch is set.
- Setup files that are completely incompatible will not be displayed.  
(☞ P131 [Configuring Setup Files])

### 5 Select [Load] on the confirmation screen, and press the Set button (●).

Loading starts, and “Loading...” appears on the screen.

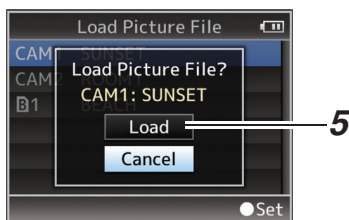

### 6 Reading is complete.

After reading of the file is complete, “Complete” appears on the screen, and the menu screen closes automatically.

## Deleting Setup Files

- 1 **Display the [Setup File] menu.**  
Select [Main Menu] → [System] → [Setup File] and press the Set button (●).  
(☞ P110 [ Setup File ])
- 2 **Select [Delete File] and press the Set button (●).**
- 3 **Select [Scene File] or [Picture File], and press the Set button (●).**  
The existing files are displayed.
- 4 **Select the file to delete using the cross-shaped button (▲▼), and press the Set button (●).**

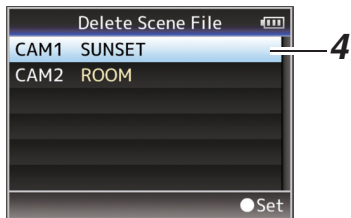

Memo : \_\_\_\_\_

- Scene files saved on the SD card cannot be deleted.

- 5 **Select [Delete] on the confirmation screen, and press the Set button (●).**  
Deletion starts, and “Deleting...” appears on the screen.

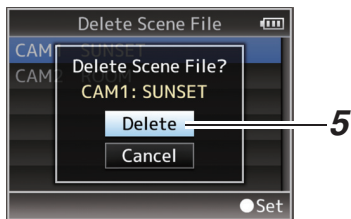

- 6 **Deletion is complete.**  
After file deletion is complete, “Complete” appears on the screen.

# Managing/Editing Clips on a PC

## Loading Clips to the PC (USB Connection Mode)

- You can load clips to a PC by connecting the camera recorder to the PC via the USB port. Doing so enables clips stored in the SD card to be managed and edited on the PC.
- Files on the SD card can be managed/edited on the connected PC in this mode only for USB mass storage class devices that are recognized by the said PC as a peripheral drive.

Memo : \_\_\_\_\_

- Files cannot be written to the SD card.
- Make sure to manage/edit files recorded in the MP4 file format using the (JVC ProHD Clip Manager) PC application software in the supplied disc.
- For details on how to install the application software, refer to the [User's Guide] of the [JVC ProHD Clip Manager] inside the supplied disc.

### 1 Connect the camera recorder to the PC using a USB cable.

A confirmation message "Change to USB Mode?" to enable the USB connection appears.

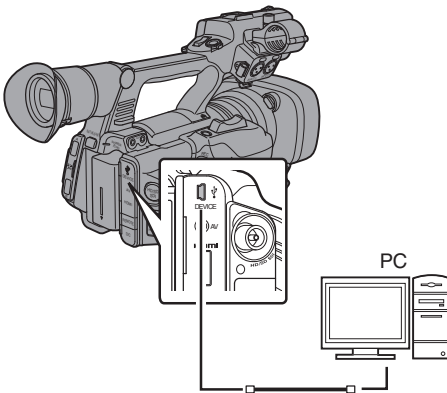

- 2 Select [Change] using the cross-shaped button (▲▼), and press the Set button (●). The camera recorder switches to USB mode.

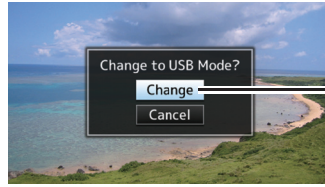

Memo : \_\_\_\_\_

- If recording is in progress, the "Change to USB Mode?" message appears after recording stops.
- If playback is in progress, the camera recorder switches to USB mode after the file closes automatically, such as when playback stops.

### Disconnecting

- Disable the connection on the PC, then remove the USB cable from the camera recorder.
- Doing so exits the USB mode and switches the camera recorder to Camera mode.

Memo : \_\_\_\_\_

- The procedure for disabling the USB connection varies according to the PC in use. For details, refer to the instruction manual of the PC.

## When your PC cannot recognize the SD card

Confirm and update the OS of your PC.

OS	Description
Windows XP/ Windows XP SP1	Necessary to update to SP2 or higher.
Windows XP SP2/ Windows XP SP3	Necessary to download the update software. (KB955704) <a href="http://www.microsoft.com/downloads/details.aspx?familyid=1CBE3906-DDD1-4CA2-B727-C2DFF5E30F61&amp;displaylang=en">http://www.microsoft.com/downloads/details.aspx?familyid=1CBE3906-DDD1-4CA2-B727-C2DFF5E30F61&amp;displaylang=en</a>
Windows Vista	Necessary to update to SP1 or higher.
Windows Vista SP1/ Windows Vista SP2	Necessary to download the update software. (KB975823) <ul style="list-style-type: none"> <li>• 32 bit version <a href="http://www.microsoft.com/downloads/en/details.aspx?FamilyID=2d1abe01-0942-4f8aabb2-2ad529de00a1">http://www.microsoft.com/downloads/en/details.aspx?FamilyID=2d1abe01-0942-4f8aabb2-2ad529de00a1</a></li> <li>• 64 bit version <a href="http://www.microsoft.com/downloads/en/details.aspx?FamilyID=7d54c53f-017c-4ea5-ae08-34c3452ba315">http://www.microsoft.com/downloads/en/details.aspx?FamilyID=7d54c53f-017c-4ea5-ae08-34c3452ba315</a></li> </ul>
Windows 7	Necessary to download the update software. (KB976422) <ul style="list-style-type: none"> <li>• 32 bit version <a href="http://www.microsoft.com/downloads/en/details.aspx?FamilyID=3ee91fc2-a9bc-4ee1-aca3-2a9aff5915ea">http://www.microsoft.com/downloads/en/details.aspx?FamilyID=3ee91fc2-a9bc-4ee1-aca3-2a9aff5915ea</a></li> <li>• 64 bit version <a href="http://www.microsoft.com/downloads/en/details.aspx?FamilyID=73f766dd-7127-4445-b860-47084587155f">http://www.microsoft.com/downloads/en/details.aspx?FamilyID=73f766dd-7127-4445-b860-47084587155f</a></li> </ul>

## Connecting External Monitor

- To output live or playback video images and audio sound to an external monitor, select the output signals from the camera recorder, and connect using an appropriate cable according to the monitor to be used.
- Choose the most suitable terminal according to the monitor in use.
- [HD/SD SDI] terminal:  
Outputs either the HD-SDI signal or SD-SDI signal.
- [AV] terminal:  
Outputs composite video and audio signals.
- [HDMI] terminal:  
Outputs HDMI signals.  
Configure the settings in the [A/V Set] menu to match the monitor to be connected.  
(P107 [ HDMI/SDI Out ] )

Memo :

- When [Network] is set to “On(HDMI Off)” or “On(SDI Off)”, either HDMI signal or SDI signal is output.

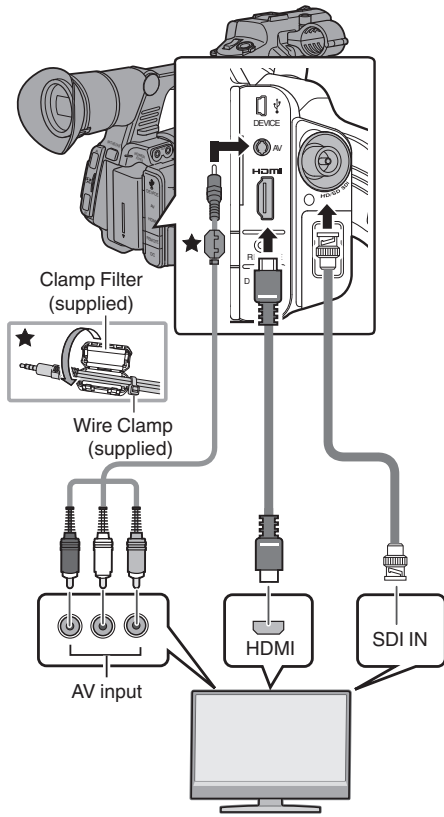

## Connecting via SDI

- Digital video signals, together with embedded (superimposed) audio signals and time code signals, are output for both the HD-SDI and SD-SDI signals.
- User's bit output from the [HD/SD SDI] output terminal is used as a flag to determine valid video signals. Therefore, accurate values will not be output.

Memo :

- The sampling frequency for embedded (superimposed) audio signals is 48 kHz. Time code of the built-in time generator as well as playback time code are also output.

### Settings for SDI Down-Converted Output

- You can select the method to “down convert” HD video images to SD images during SD-SDI output.
- Set using [A/V Set] → [Video Set] → [SD Aspect].
- The available modes include “Side Cut”, “Letter” (blackened at the top and bottom), and “Squeeze” (full size, compressed at the left and right).  
(☞ P113 [ SD Aspect ])

Memo :

- When [Record Format] → [System] is set to “SD”, and [SD Aspect] is set to “4:3”, this item cannot be selected.  
(☞ P111 [ System ])

\* Select the display pattern in [A/V Set] → [HDMI/SDI Out].  
(☞ P107 [ HDMI/SDI Out ])

\* When [Record Format] → [System] is set to “SD”, only SD-SDI signals are output.  
(☞ P111 [ System ])

\* To display the menu screen or display screen on an external monitor, set [A/V Set] → [Video Set] → [Display On TV] to “On”.  
(☞ P107 [ Display On TV ])

## Connecting the Headphone

- Audio output from the [Ω] terminal can be selected using [A/V Set] → [Monitor] or the [MONITOR] selection switch on the camera recorder.  
(P109 [ Monitor ])
- The different combinations of settings that are output from the [Ω] terminal and monitor speaker are as follows.

[MONITOR] Switch Settings	[Monitor] Settings	[Ω] terminal		Speaker *
		L	R	
[CH1]	-	CH1		CH1
[BOTH]	[Mix]	CH1+CH2		CH1+CH2
	[Stereo]	CH1	CH2	
[CH2]	-	CH2		CH2

\* Audio is output from the speaker only in Media mode. Does not output in the Camera mode.

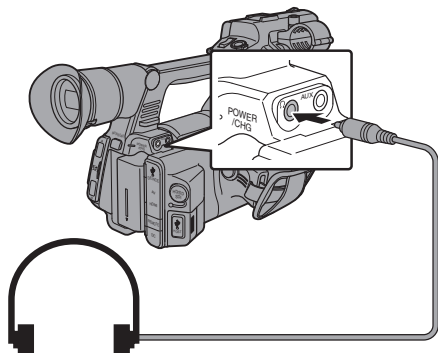

Memo : \_\_\_\_\_

- If both CH1 and CH2 are built-in microphones, stereo sound is output from the [Ω] terminal regardless of the [MONITOR] switch setting and [Monitor] setting.

## Connecting Wired Remote Control

The functions of the camera recorder can be configured using a wired remote control.

Memo : \_\_\_\_\_

- When the switches of the camera recorder and remote control unit are operated at the same time, the switch operation of the remote control unit takes priority over that of the camera recorder.

### 1 Connect a wired remote control to the camera recorder.

Connect the wired remote control (sold separately) to the [REMOTE] terminal of this camera recorder.

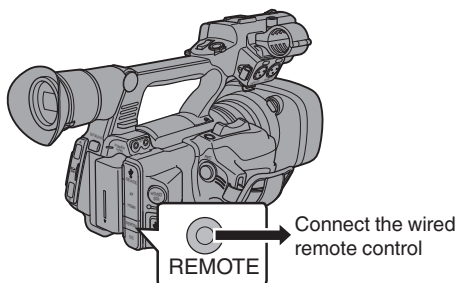

Caution : \_\_\_\_\_

- Turn off the power of the camera recorder when connecting a wired remote control.

### 2 Turn on the power of the camera recorder.

# Functions of Network Connection

- The network function can be operated by connecting one of the following adapters to the rear [HOST] terminal.
  - USB wireless LAN adapter
  - USB-Ethernet adapter
  - USB-Cellular adapter(☞ P139 [Camera Setup for Network Connection])
- The network feature comes with a browser-based function that makes use of devices such as smartphones, tablet terminals, and PCs, as well as an FTP function for executing operations on the thumbnail screen or menu.

## List of Functions

### Importing Metadata

You can download a metadata settings file (XML format) from the FTP server and store metadata in the camera recorder.

(☞ P142 [Importing Metadata])

### Uploading Recorded Clips

You can upload clips recorded in the SD card to a preset FTP server.

(☞ P144 [Uploading a Recorded Video Clip])

### Editing Metadata

- Planning Metadata  
You can access the page for editing the camera recorder's metadata via a browser on devices such as a smartphone, tablet terminal, or PC, and edit the metadata that is to be applied to clips to be recorded.  
(☞ P147 [Planning Metadata])
- Clip Metadata  
You can access the page for editing the camera recorder's metadata via a browser on devices such as a smartphone, tablet terminal, or PC, and display or rewrite the metadata that is recorded to a clip.  
(☞ P148 [Clip Metadata])

### View Remote

You can access via a browser on devices such as a smartphone, tablet terminal, or PC to check the live image or remotely control the camera.

(☞ P150 [View Remote Feature])

# Preparing Network Connection

## Operating Environment

### Computer

- CPU  
Core 2 Duo 2.4 GHz or higher
- Memory  
2 GB or higher
- Display  
1024x768 or higher
- OS
  - Windows XP SP3/Windows Vista SP2 (32 bit/64 bit)/Windows7 SP1 (32 bit/64 bit)
  - Mac OS X v10.5 or later
- Web Browser
  - Internet Explorer 8 or later
  - Safari 5.1 or later
  - Google Chrome 21.0 or later
  - Mozilla Firefox 15 or later

### Smartphone/Tablet Terminal

- iPhone/iPad/iPod touch  
iOS 5.1.1 or later (Safari 5.1 or later)
- Android Smartphone  
Android 4.0 or later (standard browser)

## Camera Setup for Network Connection

### 1 Connect an appropriate adapter according to the intended use to the [HOST] terminal at the rear of the camera recorder.

The following adapters can be connected.

- USB wireless LAN adapter
- USB-Ethernet adapter
- USB-Cellular adapter

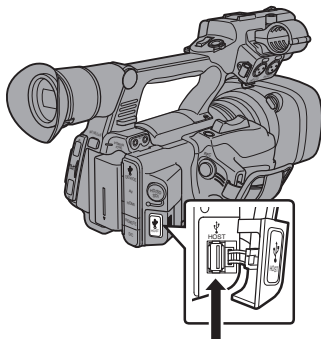

Connect an appropriate adapter

Memo :

- Only a network connection adapter can be connected to the [HOST] terminal.
- Connect or disconnect an adapter only after you have turned off the power of the camera recorder.
- You can find the latest information on the compatible adapters at the product page of our website.
- Two types of network coverage (WAN and LAN) are available for each application.

### 2 Enable the network connection.

Set [Main Menu] → [System] → [Network] to “On(HDMI Off)” or “On(SDI Off)”.

### 3 Configure the connection settings.

- Select [Main Menu] → [System] → [Network] → [Settings] → [Connection Setup] → [Wizard] and press the Set button (●).
- A wizard screen appears according to the type of adapter connected. Follow the instructions on the screen to perform setting.

(☞ P139 [Connecting via Wireless LAN] )

(☞ P141 [Connecting via Wired LAN] )

(☞ P141 [Connecting via 3G Adapter] )

## Connecting via Wireless LAN

### Connection via Access Point

#### 1 Perform setting on the camera recorder, and start up the [Wizard] screen.

(☞ P139 [Camera Setup for Network Connection] )

#### 2 [Wireless LAN] appears on the [Wizard] screen.



#### 3 Press the ► button to display the [Select Connection Type] screen.

Select “Connect with Access Point”.

Follow the screen instructions to complete setting. Perform setting for the following.

- Mode of connection
- Method of setting
  - \* SSID, type of encryption, Passphrase, and IP Address setting (“DHCP” or “Manual”) in cases other than WPS

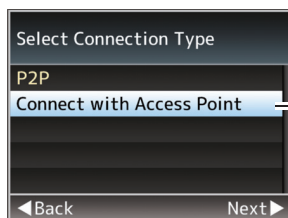

#### 4 Setting is complete.

After setting is complete, you can access the camera recorder via a browser.

(☞ P146 [Connecting via a Browser] )

## P2P Connection

You can access the web function of this camera recorder from devices such as a smartphone, tablet terminal, or PC.

### 1 [Wireless LAN] appears on the [Wizard] screen.



### 2 Press the ► button to display the [Select Connection Type] screen.

Select "P2P".

Follow the screen instructions to complete setting.

Perform setting for the following.

- Mode of connection
- Method of setting
- \* SSID and Passphrase in cases other than WPS

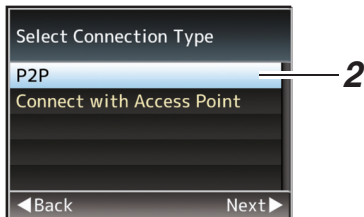

Memo : \_\_\_\_\_

- When "WPS" is selected in the [Select Setup Type] screen, the following steps 3 and 4 are not required.

### 3 Set the camera recorder to the Camera mode, and display the [Network] (status) screen.

- Press the [STATUS] button on the camera recorder to display the status screen. Press the cross-shaped button (◀▶) to display the [Network] screen.
- Check to ensure that the [SSID] and [Passphrase] that you have set in the wizard are displayed.

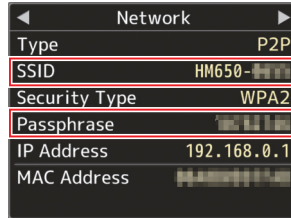

### 4 Select [SSID] from the list of access points (smartphone, tablet terminal, PC, etc.), and enter [Passphrase].

- Display the list of access points in the wireless connection settings of the smartphone, tablet terminal, or PC, and select "HM650-\*\*\*\*\*". (The "\*\*\*\*\*" portion varies according to the device.)
- After the password confirmation screen appears, enter the [Passphrase] displayed on the [Network] screen.

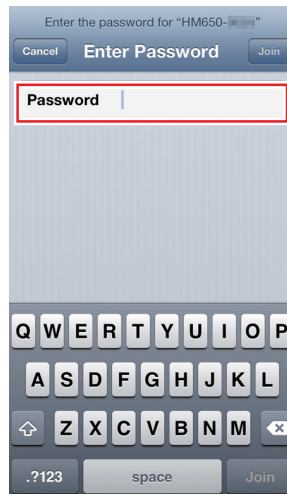

### 5 Setting is complete.

After setting is complete, you can access the camera recorder via a browser.

(P146 [Connecting via a Browser])

## Connecting via Wired LAN

You can connect a device such as a smartphone, tablet terminal, or PC directly to the camera recorder using a cross cable to access the camera recorder's web functions.

- 1 Connect the [HOST] terminal on the camera recorder to the smartphone, tablet terminal, PC, etc. using a cross cable.
- 2 Perform setting on the camera recorder, and start up the [Wizard] screen.  
(☞ P139 [Camera Setup for Network Connection])
- 3 [Ethernet] appears on the [Wizard] screen.

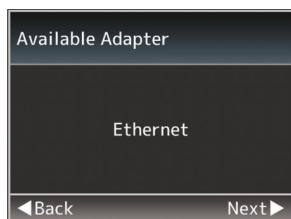

- 4 Press the ► button to display the [IP Address Configuration] screen.  
Follow the screen instructions to complete setting. Perform setting for the following.
  - IP address setting (DHCP or manual)
  - IP Address
  - Subnet Mask
  - Gateway
  - DNS Server

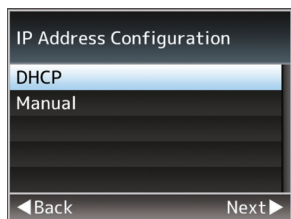

- 5 Setting is complete.  
After setting is complete, you can access the camera recorder via a browser.  
(☞ P146 [Connecting via a Browser])

## Connecting via 3G Adapter

You can make use of the FTP function by connecting a USB-Cellular adapter to this camera recorder.

- 1 Connect the USB-Cellular adapter to the [HOST] terminal of the camera recorder.
- 2 Perform setting on the camera recorder, and start up the [Wizard] screen.  
(☞ P139 [Camera Setup for Network Connection])
- 3 [Cellular] appears on the [Wizard] screen.

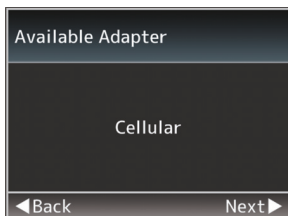

- 4 Press the ► button to display the [Select Carrier] screen.

Follow the screen instructions to complete setting. Perform setting for the following.

- Carrier selection
- Access point
- Connection phone number
- User name

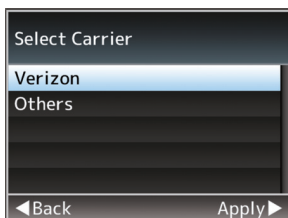

Caution : \_\_\_\_\_

- You can access the web functions via a browser on devices such as a smartphone, tablet terminal, or PC only in a LAN environment.
- Note that you may have to pay very high bills in the case of pay-per-use contracts. Fixed price contract is recommended if you are using the network function.
- Note that you may have to pay very high bills if the APN is incorrectly set. Make sure that the setting is correct.
- There may be communication even when you are not using the network function.  
Remove the adapter when the function is not in use.

# Importing Metadata

You can download a metadata settings file (XML format) from the FTP server and store metadata in the camera recorder. The imported metadata is applied to clips to be recorded.

## Preparing Metadata

- You can record one of the four metadata types below.
  - Title1 : Not more than 63 characters
  - Title2 : Not more than 127 characters
  - Creator : Not more than 127 characters
  - Description : Not more than 2047 characters
- Only ASCII characters (single-byte alphanumeric characters and symbols) are usable.
- Metadata makes use of the XML description format.
- Edit the <Title1><Title2><Description><Creator> tag element using the XML editor. (Indicated by the frames below)

```
<?xml version="1.0" encoding="UTF-8"?>
<NRT-MetaInterface lastUpdate="2012-07-26T18:06:21+09:00"
xmlns="urn:schemas-proHD:nonRealTimeMetaInterface:ver.1.00"
xmlns:xsi="http://www.w3.org/2001/XMLSchema-instance">
  <MetaData>
    <Title1>Title1 sample</Title1>
    <!-- only "en",max63bytes -->
    <Title2>Title2 sample</Title2>
    <!-- only "en",max127bytes -->
    <Description>Description sample</Description>
    <!-- only "en",max2047bytes -->
    <Creator>Creator sample</Creator>
    <!-- only "en",max127bytes -->
  </MetaData>
</NRT-MetaInterface>
```

## Configuring the Server for Downloading

For specifying the settings for connecting to the FTP server for downloading the metadata (domain name, user name, password, etc.) as well as the path of the file to download.

### 1 Open the [Metadata Server] screen.

Open the [Main Menu] → [System] → [Network] → [Settings] → [Metadata Server] screen.

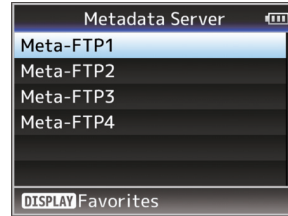

### 2 Register the [Metadata Server].

- Select a server using the cross-shaped button (▲▼), and press the Set button (●). The server settings screen appears. Perform setting for each item.
- Up to 4 settings can be registered. (P116 [ Metadata Server ])

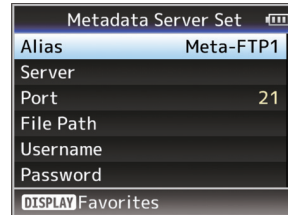

Memo : \_\_\_\_\_

- For details on the registered information, please consult the network administrator for the server.

## Importing Metadata

Download the metadata settings file (XML format) from the FTP server.

- 1 Select [Main Menu] → [System] → [Network] → [Import Metadata] and press the Set button (●).

The [Import Metadata] screen appears.

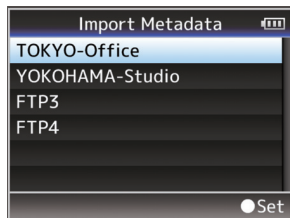

- 2 Select the server for importing the metadata.

- The name that is registered in [Metadata Server] → [Alias] is displayed.
- Select a server using the cross-shaped button (▲▼), and press the Set button (●).

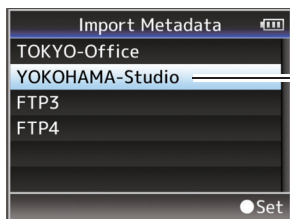

- 3 Select [Import] on the confirmation screen, and press the Set button (●).

Import starts.

After import is complete, the display is restored to the screen before the [Import Metadata] screen appears.

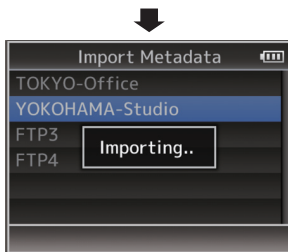

Memo :

- You cannot exit the menu or perform recording while import is in progress.
- If import of the metadata failed, "Import Error!" is displayed, and a message indicating the cause of the error appears. Press the Set button (●) to return to the [Import Metadata] screen in step 1.

(P161 [List of FTP Transfer Errors] )

# Uploading a Recorded Video Clip

Upload clips recorded in the SD card to a preset FTP server.

## Configuring the FTP Server for Uploading

For specifying the settings for connecting to the FTP server to upload recorded clips to (domain name, user name, password, etc.) as well as the directory of the upload destination.

### 1 Open the [Clip Server] screen.

Open the [Main Menu] → [System] → [Network] → [Settings] → [Clip Server] screen.

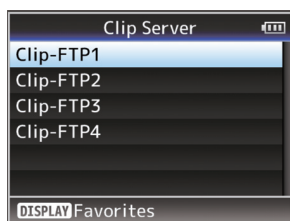

### 2 Register the [Clip Server].

Register the server to upload recorded clips in the SD card to.

Up to 4 servers can be registered.

(P116 [Clip Server])

Memo : \_\_\_\_\_

- For details on the registered information, please consult the network administrator for the server.

## Uploading Video Clip

Upload clips recorded in the SD card to a preset FTP server.

All playable clips on the thumbnail screen can be uploaded.

### Uploading a Video Clip

#### 1 Set the camera recorder to the Media mode.

- Press and hold the [MODE] selection button in Camera mode to enter Media mode. A thumbnail screen of the clips recorded on the SD card is displayed.
- You can upload the selected clips on the thumbnail screen to the FTP server.

(P83 [Thumbnail Screen])

- 2 Move the cursor to the clip to be uploaded. Move the cursor to the clip to be uploaded using the cross-shaped button (▲▼◀▶).



#### 3 Press the [LOLUX/3] button.

The action selection screen is displayed.

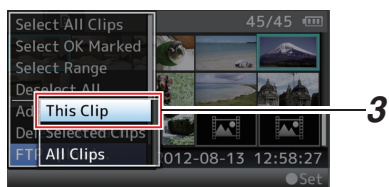

#### 4 Select [FTP Upload] → [This Clip] → server to upload to, and press the Set button (●).

The status of the transfer process is indicated by a progress bar.

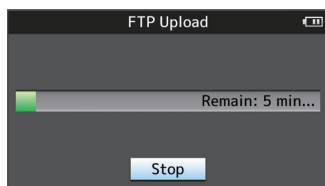

Memo : \_\_\_\_\_

- The options for the server to upload files to are indicated using the preset names in [Clip Server] → [Alias].
- To stop uploading, press the Set button (●). Select [Yes] on the confirmation screen, and press the Set button (●) to stop uploading and return to the thumbnail screen.
- When uploading starts, the [MODE] selection button is disabled until uploading is completed or stopped.

### 5 Upload is complete.

- After upload is complete, “Successfully Completed.” appears on the screen.
- Press the Set button (●) to return to the thumbnail screen.

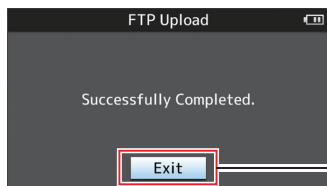

### Selecting and Uploading Multiple Clips

To select and upload multiple clips, refer to “[Selecting and Performing Operations on Multiple Clips] P 89”.

### Uploading All Video Clips

#### 1 Press the [LOLUX/3] button.

The action selection screen is displayed.

#### 2 Upload the clips.

Select [FTP Upload...] → [All Clips] → server to upload to, and press the Set button (●).

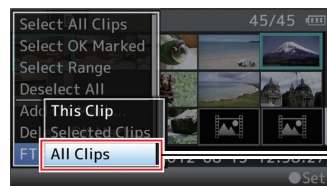

### 3 Upload starts.

The status of the transfer process is indicated by a progress bar.

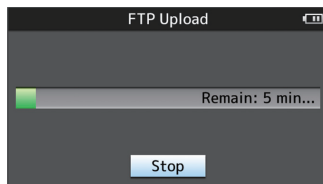

Memo :

- To stop uploading, press the Set button (●). Select [Yes] on the confirmation screen, and press the Set button (●) to stop uploading and return to the thumbnail screen.
- If the file to be uploaded has the same file name as an existing file in the FTP server, an overwrite confirmation window appears.
- When “HTTP” is selected in the [Select FTP Proxy] screen of the network connection setting, the overwrite confirmation window will not be displayed and the existing file is overwritten.

### 4 Upload is complete.

- After all clips are uploaded successfully, “Successfully Completed.” is displayed. Press the Set button (●) to return to the thumbnail screen.
- When clips are not uploaded successfully, the following errors are displayed.

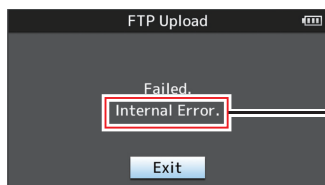

(☞ P161 [List of FTP Transfer Errors] )

# Connecting via a Browser

You can access the web functions of this camera recorder via a browser on devices such as a smartphone, tablet terminal, or PC. Make the necessary preparations for connection in advance.

(☞ P139 [Connect an appropriate adapter according to the intended use to the [HOST] terminal at the rear of the camera recorder.] )

## 1 Set the camera recorder to the Camera mode, and display the [Network] (status) screen.

- Press the [STATUS] button on the camera recorder to display the status screen. Press the cross-shaped button (◀▶) to display the [Network] screen.
- Check the displayed [IP Address].

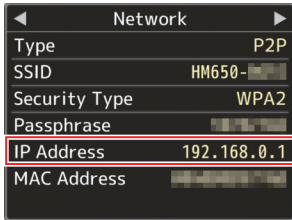

## 2 Start up the browser on the terminal you wish to connect to the camera recorder, and enter the [IP Address].

(Example: 192.168.0.1)

If "192.168.0.1" is displayed in [IP Address], enter "http://192.168.0.1".



## 3 Enter the user name and password.

Enter the user name (prohd) and the password (initial password: 0000) on the login screen to display the main page of the camera.

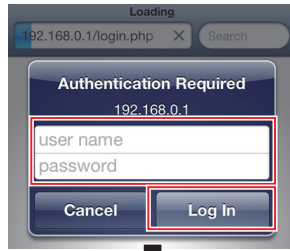

Memo : \_\_\_\_\_

- The password can be altered in [Main Menu] → [System] → [Network] → [Settings] → [Web] → [Change Password]. (☞ P115 [ Change Password ] )

# Editing Metadata

You can create the metadata to be inserted into a recorded file, or rewrite the metadata of a recorded clip.

## Planning Metadata

You can access the page for editing the camera recorder's metadata via a browser on devices such as a smartphone, tablet terminal, or PC, and edit the metadata that is to be applied to clips to be recorded.

### 1 Access the main page of the camera.

Access the page from a device such as a smartphone, tablet terminal, or PC.  
(P146 [Connecting via a Browser])

### 2 Tap (click) the [Planning Metadata] tab to open the [Planning Metadata] screen.



## 3 Editing Metadata

- 1 Enter information for the necessary fields.
- 2 After input is complete, tap (click) [Save] to overwrite the metadata.

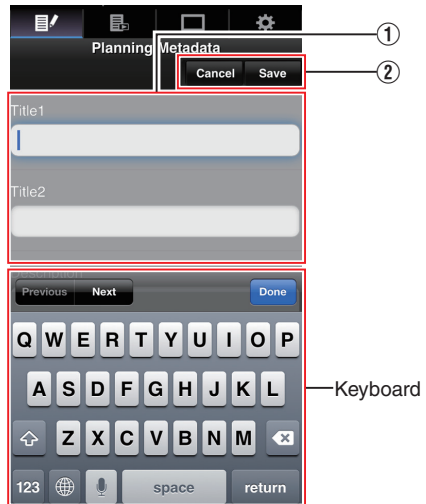

### 4 Tap (click) [OK] on the confirmation screen.

- Update of the [Planning Metadata] starts.
- After update is complete, "Renewal of planning metadata is succeeded." is displayed. Tap (click) [OK].
- Returns to the screen in step 3.



Memo : \_\_\_\_\_

- If update failed, "Renewal of planning metadata is succeeded." is displayed.  
Tap (click) [Close] to return to the screen of step 3.

## Clip Metadata

You can access the page for editing the metadata via a browser on devices such as a smartphone, tablet terminal, or PC, and display or rewrite the metadata that is recorded to a clip.

### 1 Access the main page of the camera.

Access the page from a device such as a smartphone, tablet terminal, or PC.  
(P146 [Connecting via a Browser])

### 2 Tap (click) the [Clip Metadata] tab to start up the [Clip Metadata].



### 3 Set the camera recorder to the “Remote Edit Mode”.

- “Change to Remote Edit Mode?” appears on the display screen of the camera recorder.
- Select [Change] and press the Set button (●) to switch to the Remote Edit Mode.

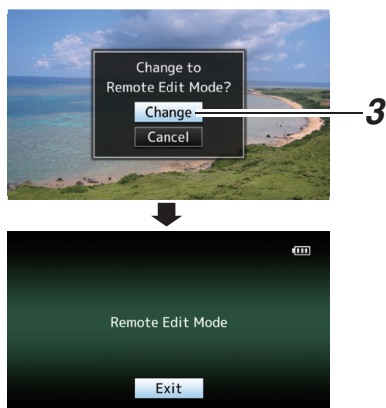

Memo : \_\_\_\_\_

- When the menu or status is displayed, display of the confirmation screen will be put on hold.
- If the menu is displayed on the camera recorder, close the menu.
- If the status is displayed on the camera recorder, close the status display.
- Pressing the Set button (●) on the camera recorder while in the Remote Edit Mode ends the Remote Edit Mode forcibly and switches to the Camera mode.

### 4 Select the clip to rewrite the metadata.

- A list of recorded clips appears on the [Clip Metadata] screen.
- Tap (click) the clip for which you want to rewrite the metadata.

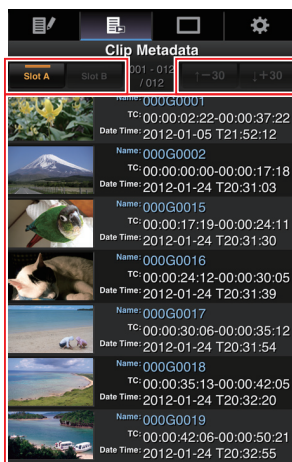

Memo : \_\_\_\_\_

- You can switch the displayed slot using the [Slot A] and [Slot B] tabs.
- You can jump through the displayed clips backward or forward by 30 clips each using the [←30] and [→+30] tabs.

## 5 Editing the Metadata of Selected Clips

- 1 Edit the information for the necessary fields.
  - If you are using a PC, input using the mouse and keyboard.
  - If you are using a smartphone or tablet terminal, tap the text input area to display a standard software keyboard on the screen. Enter the information using the displayed keyboard.
- 2 You can tap (click) [OK Mark] to add an OK mark to or delete it from selected clips.
- 3 After editing is complete, tap (click) [Save] to overwrite the metadata.



## 6 Tap (click) [OK] on the confirmation screen.

- Update of the metadata starts.
- After update is complete, “Renewal of clip metadata is succeeded.” is displayed. Tap (click) [OK].
- Returns to the screen in step 4.



Memo :

- If update failed, “Renewal of clip metadata is failed.” is displayed. Tap (click) [Close] to return to the screen of step 4.

# View Remote Feature

You can access via a browser on devices such as a smartphone, tablet terminal, or PC to check the live image and perform the following remote control operations.

- Start/stop recording
- Zooming
- Register/delete preset zoom

## 1 Access the main page of the camera.

Access the page from a device such as a smartphone, tablet terminal, or PC.  
(☞ P146 [Connecting via a Browser])



## 2 Tap (click) the [View Remote] tab to open the [View Remote] screen.

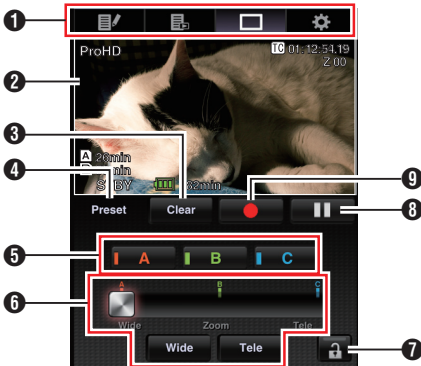

## Operating Procedure



- 1 Page Switch Tab**  
Tap (click) this tab to move to the [Planning Metadata], [Clip Metadata], or [Settings] screen.
- 2 Live View Screen**  
Displays the live images.  
Tap a live image to display or hide information that is displayed on the live image, such as remaining space on the media and time code.
- 3 [Clear] Button**  
Switches to the Delete Preset Zoom Position mode.  
(☞ P151 [Registering/Deleting Preset Zoom])  
(☞ P152 [Deleting a Preset Zoom])
- 4 [Preset] Button**  
Switches to the Register Preset Zoom Position mode.  
(☞ P151 [Registering Preset Zoom])
- 5 [A]/[B]/[C] Buttons**  
Use these buttons to perform preset registration or delete a preset data.
- 6 Zoom Control**
  - Operate the zoom function by dragging the zoom button along the sliding bar.
  - Tap (click) the [Wide] or [Tele] button to fine-tune the zoom position.
- 7 Function Lock Button**  
Locks the functions that have been set on the [Settings] screen.  
(☞ P153 [Changing View Remote Function Settings])

Icon	Description
	Locked
	Not locked

- 8 Stop Record Button**
- 9 Start Record Button**

## Registering/Deleting Preset Zoom

### Registering Preset Zoom

You can register any 3 zoom positions.

#### 1 Set to the Register Preset Zoom mode.

Tap (click) the [Preset] button to switch to the Register Preset Zoom mode.



#### 2 Determine the zoom position.

Use the zoom control to operate the zoom and determine a position.

#### 3 Tap (click) [A].

Position [A] is registered, and position A is displayed on the sliding bar of the zoom control.



#### 4 In the same way, register [B] and [C].

After all three positions A, B and C are registered, the positions of the [A], [B], and [C] buttons will be rearranged according to the order of the registered zoom position from the left.

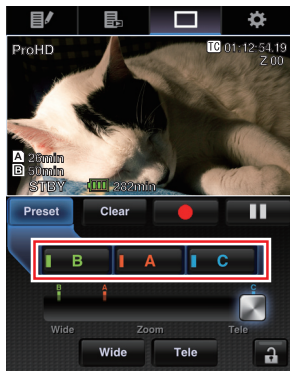

#### 5 Cancel the Register Preset Zoom mode.

Tap (click) the [Preset] button to cancel the Register Preset Zoom mode.

Memo :

- After registration is complete ([A], [B], and [C] buttons are all active), tapping (clicking) each button switches to the corresponding preset zoom position.
- This function operates independently of the preset zoom position on the camera recorder. (P48 [Saving/Recalling Current Zoom Position (Preset Zoom)])

## Deleting a Preset Zoom

- 1 Set to the Delete Preset Zoom mode.**  
When any of positions [A], [B], and [C] are registered, tapping (clicking) the [Clear] button switches to the Delete Preset Zoom mode.



- 2 Tap (click) the [A], [B], or [C] button that corresponds to the position you want to delete.**
  - The position is deleted, and the button is grayed out.
  - The corresponding zoom position mark on the sliding bar also disappears.



Grayed out  
Position mark disappears

- 3 Cancel the Delete Preset Zoom mode.**  
Tap (click) the [Clear] button to cancel the Delete Preset Zoom mode.

Memo :

- The Clip Review function of the camera recorder is unavailable during View Remote operation.  
(P146 [Viewing Recorded Videos Immediately (Clip Review)])

## Configuring Settings via a Browser

You can change the network-related settings by accessing via a browser on devices such as a smartphone, tablet terminal, or PC.

- 1 Access the main page of the camera.**  
Access the page from a device such as a smartphone, tablet terminal, or PC.  
(P146 [Connecting via a Browser])
- 2 Tap (click) the [Settings] tab.**



- 3 Open the [Settings] screen.**  
Set each of the items as follows.

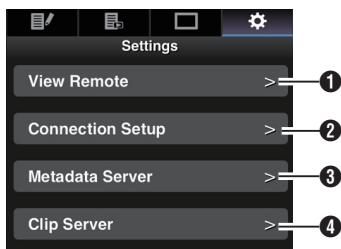

- 1 View Remote  
Settings for operations on the View Remote.
- 2 Connection Setup  
Settings related to the network.  
You can change the settings for each of the preset items on the [Wizard] screen of the camera recorder.
- 3 Metadata Server  
Settings on the server for importing the metadata.  
Setting can be performed in the same way as the Metadata Server menu on the camera recorder.  
The latest settings are reflected, regardless of whether they are specified by the camera recorder or web operation.
- 4 Clip Server  
Settings for the server to upload recorded clips to.  
Setting can be performed in the same way as the [Clip Server] menu on the camera recorder.  
The latest settings are reflected, regardless of whether they are specified via the camera recorder or web operation.

Memo : \_\_\_\_\_

- Priority is given to menu operation on the camera recorder.
- When the menu on the camera recorder is opened while the [Settings] screen is opened using the browser, a warning appears, after which the display returns to the main screen.
- While the menu is displayed on the camera recorder, the [Settings] screen cannot be opened via the browser.

## Changing View Remote Function Settings

For performing setting for using the View Remote function.

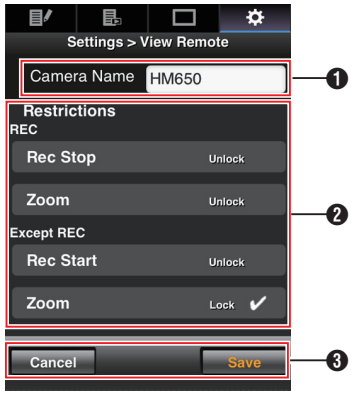

- 1 [Camera Name]
  - For setting the name that appears at the top left of the view screen.
  - Tapping the text input area displays a software keyboard.  
If you are using a PC, enter using the PC keyboard.
  - By tapping the Go key after input is complete, the software keyboard disappears.
- 2 [Restrictions]
 

For setting the buttons to be disabled on the View screen while in the locked mode.

  - [REC]:  
For setting whether to disable the Stop Record button or zoom operation during recording.  
Tap (click) each item to switch between [Unlock] and [Lock].
  - [Except REC]:  
For setting whether to disable the Stop Record button or zoom operation in any mode other than the recording mode.  
Tap (click) each item to switch between [Unlock] and [Lock].
- 3 [OK]/[Cancel]
 

Tap (click) [OK] to save the settings.  
Tap (click) [Cancel] to stop setting and return to the main [Settings] screen.

## Changing Connection Setup

You can change the settings for each of the preset items on the [Wizard] screen of the camera recorder.

- If all the items cannot be displayed in a single page, scroll down to display the remaining items.
- Items that cannot be changed are grayed out according to the type of adapter connected and the mode of connection.

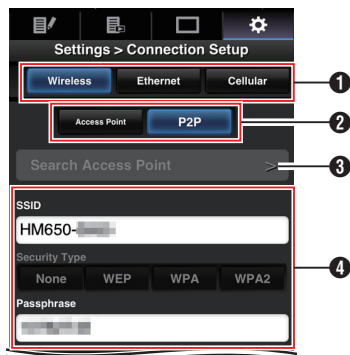

1 Type of Adapter Connected

2 Mode of Wireless LAN Connection

3 [Search Access Point] Button

Tap (click) to display a list of the detected access points.

The currently selected access point is indicated by a dot mark (•).



4 Settings on the [Select Setup Type] Screen

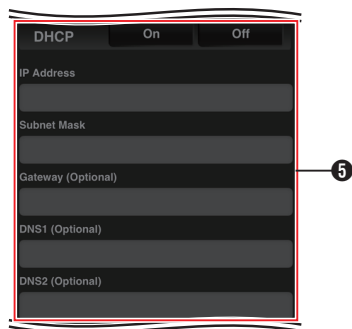

5 Settings on the [IP Address Configuration] Screen

When "DHCP" is selected, all items will be grayed out.

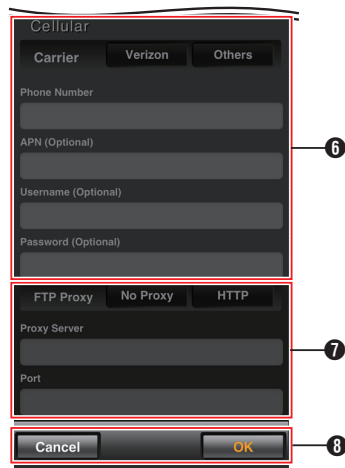

6 Settings during Use of a 3G Connection Adapter

7 Settings on the [Select FTP Proxy] Screen

8 [OK]/[Cancel] Button

After changing of settings is complete, tap (click) the [OK] button.

On the confirmation screen, tap (click) [Execute] to change the settings on the camera recorder and restart the network.

## Changing Metadata Server Settings

You can make direct changes to the FTP server for importing the metadata set in [Metadata Server] on the camera recorder, or the path of the file to import.

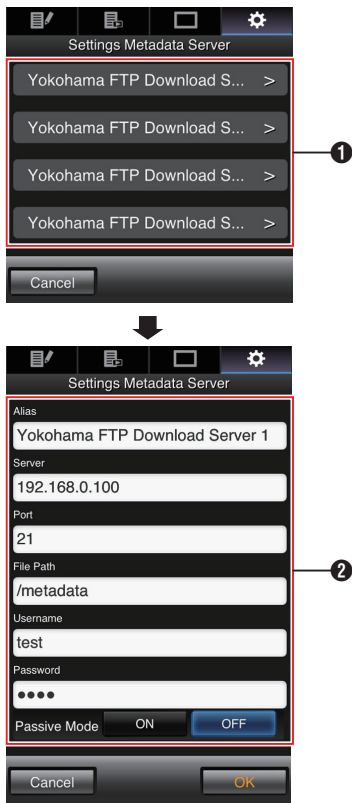

- 1 FTP Server for Importing the Metadata  
The registered FTP server name (name that is set in Alias) is displayed.
- 2 Settings Specified in [Metadata Server]  
Settings specified in [Main Menu] → [System] → [Network] → [Settings] → [Metadata Server] are displayed.  
(☞ P116 [ Metadata Server ] )

## Changing Clip Server Settings

You can make direct changes to the server and directory settings that are specified in [Clip Server] on the camera recorder for uploading recorded clips in the SD card to the FTP server.

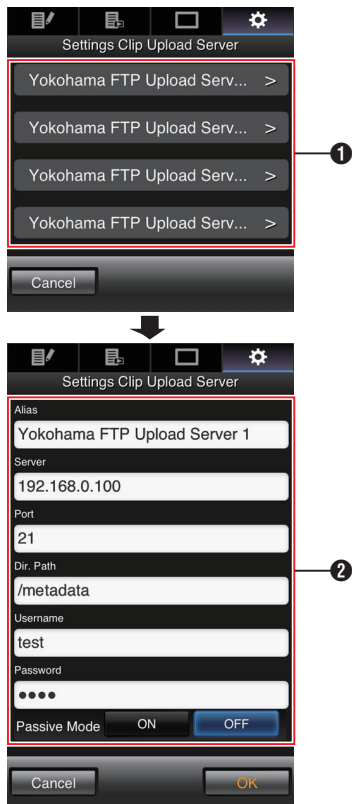

- 1 FTP Server to Upload Recorded Clips To  
The registered FTP server name (name that is set in Alias) is displayed.
- 2 Settings Specified in [Clip Server]  
Settings specified in [Main Menu] → [System] → [Network] → [Settings] → [Clip Server] are displayed.  
(☞ P116 [ Clip Server ] )

# Managing the Network Connection Settings File

This camera recorder allows you to save the network connection settings on the Wizard screen to the camera recorder unit.

Loading a saved connecting settings file enables you to reproduce the appropriate network connection state speedily.

Memo : \_\_\_\_\_

- To save or load the connection settings, go to [Main Menu] → [System] → [Network] → [Settings] → [Connection Setup].
- The following operations can be performed on the [Connection Setup] menu.
  - [Saving the Connection Settings File] P 156
  - [Reading the Connection Settings File] P 157
  - [Deleting Connection Settings] P 158

## Number of Storable Setup Files

Camera recorder : [CAM1] to [CAM4]

## | Saving the Connection Settings File

- 1 Select [Main Menu] → [System] → [Network] → [Settings] → [Connection Setup] and press the Set button (●).
- 2 Select [Store] and press the Set button (●).

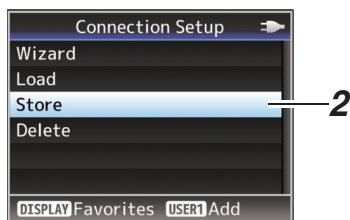

- 3 Select the file to be newly saved (or overwritten) using the cross-shaped button (▲▼), and press the Set button (●).



- 4 **Name the file.**  
Enter the subtitle using the software keyboard.  
( P93 [Text Input with Software Keyboard] )

Memo : \_\_\_\_\_

- When overwriting an existing file, the subtitle of the existing file is displayed.
- Select [Cancel] and press the Set button (●), or press the [CANCEL] button to return to the previous screen.

## 5 Select [Store] and press the Set button (●).



## 6 Save the file.

- A confirmation screen appears when you choose to overwrite. Select [Overwrite] on the confirmation screen, and press the Set button (●). Saving starts, and “Storing...” appears on the screen.

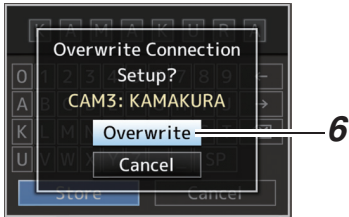

- Saving starts, and “Storing...” appears on the screen when the file is newly saved.

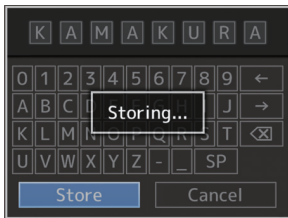

## 7 Saving is complete.

After saving of the file is complete, “Complete” appears on the screen, and the menu screen closes automatically.

## Reading the Connection Settings File

- 1 Select [Main Menu] → [System] → [Network] → [Settings] → [Connection Setup] and press the Set button (●).
- 2 Select [Load] and press the Set button (●).

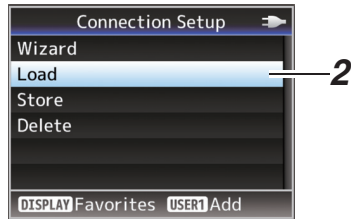

- 3 Select the file to read using the cross-shaped button (▲▼), and press the Set button (●).



- 4 Select [Load] on the confirmation screen, and press the Set button (●). Loading starts, and “Loading...” appears on the screen.

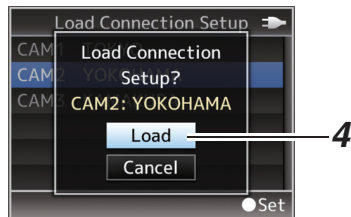

## 5 Reading is complete.

After reading of the file is complete, “Complete” appears on the screen, and the menu screen closes automatically.

## Deleting Connection Settings

- 1 Select [Main Menu] → [System] → [Network] → [Settings] → [Connection Setup] and press the Set button (●).
- 2 Select [Delete] and press the Set button (●).

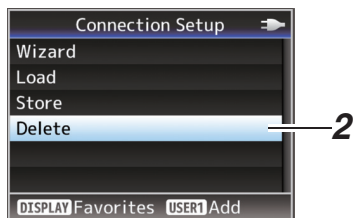

- 3 Select the file to delete using the cross-shaped button (▲▼), and press the Set button (●).



- 4 Select [Delete] on the confirmation screen, and press the Set button (●).

Deletion starts, and “Deleting...” appears on the screen.





- 5 Deletion is complete. After file deletion is complete, “Complete” appears on the screen.

# Error Messages and Actions

Warning display on the LCD monitor and viewfinder screen, tally lamp indication and warning tone are as follows according to the error status.

Memo : \_\_\_\_\_

- This camera recorder makes use of a microcomputer. Noise interference from external sources may prevent it from functioning properly. When this occurs, turn off and on the power of the camera recorder again.

Error Message		Status	Action
Display Screen	Thumbnail Screen Dedicated Screen		
TURN POWER OFF TURN BACK ON LATER	-	System error. * The warning tone sounds and the tally lamp blinks twice every second.	Turn off the power, and turn it on again. If the error persists, consult your nearest JVC dealer.
FAN STOP DETECTED PLEASE TURN P.OFF	-	<ul style="list-style-type: none"> <li>• The fan stopped running.</li> <li>• The power turns off automatically after about 1 second.</li> </ul>	Please consult your nearest JVC dealer.
FAN MAINTENANCE REQUIRED	-	Usage time of the fan has exceeded 9000 hours.	Check the fan and replace accordingly. For more details, please consult your nearest JVC dealer.  Memo : _____ <ul style="list-style-type: none"> <li>• You can check the usage time of the fan in [System] → [System Information] → [Fan Hour]. ( P111 [ Fan Hour ] )</li> </ul>
—	Getting Overheated. Please Turn Power Off.	<ul style="list-style-type: none"> <li>• The battery has exceeded the specified temperature.</li> <li>• The power turns off automatically after about 15 second.</li> </ul>	<ul style="list-style-type: none"> <li>• Wait until the temperature drops or replace the battery.</li> <li>• If the error persists, consult your nearest JVC dealer.</li> </ul>
REC INHIBITED	—	[REC] button is pressed when the write-protect switch of the SD card is set.	Turn off the write-protect switch of the SD card, or insert a recordable SD card. (  P39 [SD Card] )

Error Message		Status	Action
Display Screen	Thumbnail Screen Dedicated Screen		
LOST MEDIA INFO [*]	—	<ul style="list-style-type: none"> <li>• Card is removed while recording is in progress.</li> <li>• Card is removed while formatting is in progress.</li> <li>• Card is removed while restoring is in progress.</li> <li>• Card is removed while adding the OK mark.</li> <li>• Card is removed while writing a setup file.</li> <li>• Card is removed while deleting a clip.</li> </ul> (*: A, B)	Restore the card using this camera recorder. (☞ P42 [Restoring the SD Card] )
RECORD FORMAT INCORRECT	-	<ul style="list-style-type: none"> <li>• Video format of the file for Clip Review is different from the current [A Resolution] and [A Frame &amp; Bit Rate] setting.</li> </ul>	Set [A Resolution] and [A Frame & Bit Rate] correctly. (☞ P112 [ A Resolution ] ) (☞ P112 [ A Frame & Bit Rate ] )
MEDIA FULL	-	<ul style="list-style-type: none"> <li>• [REC] button is pressed when the media in use has no remaining space.</li> <li>• Remaining space ran out during recording.</li> </ul>	Replace the SD card with a new one.
NO CLIPS	-	No viewable clips are found on the card for Clip Review.	Insert an SD card that contains clips that can be reviewed. (☞ P39 [SD Card] ) (☞ P72 [Viewing Recorded Videos Immediately (Clip Review)] )
NO MEDIA	-	[REC] button is pressed when an SD card is not inserted.	Insert an SD card. (☞ P39 [SD Card] )
-	No Media	No SD card is found in Media mode or when the thumbnail screen is displayed.	Insert an SD card. (☞ P39 [SD Card] )
-	No Clips	No clips are found on the inserted SD card in Media mode or when the thumbnail screen is displayed.	Insert an SD card that contains playable clips. (☞ P39 [SD Card] ) (☞ P83 [Playing Recorded Clips] )
—	12h Continuation Record	The continuous recording time in AVCHD mode exceeds 12 hours and recording stops automatically.	To continue recording, press the [REC] button again.

## List of FTP Transfer Errors

If the upload of a recorded clip or download of the metadata setup file (XML format) is not successfully completed, the following errors are displayed.

Error message	Status	Action
Timeout.	Transfer was discontinued due to timeout caused by network transmission or server failure.	<ul style="list-style-type: none"> <li>• Execute again.</li> <li>• Use a different server.</li> </ul>
Media Was Removed.	SD card is removed while FTP transfer is in progress.	Insert the SD card and execute FTP transfer again.
Adapter Was Removed.	The USB network device is removed while FTP transfer is in progress.	Connect the USB network device.
Cannot Connect to Server.	Unable to connect to the FTP server.	Adjust the Server and Port settings for [Metadata Server] or [Clip Server]. ( P116 [ Metadata Server ] ) ( P116 [ Clip Server ] )
Access Denied.	Access is denied.	Adjust the Server and Port settings for [Metadata Server] or [Clip Server]. ( P116 [ Metadata Server ] ) ( P116 [ Clip Server ] )
Invalid Username or Password.	Authentication for login to the FTP server failed.	Adjust the Username and Password settings for [Metadata Server] or [Clip Server]. ( P116 [ Metadata Server ] ) ( P116 [ Clip Server ] )
Invalid Path Was Requested.	The path specified for the FTP server is incorrect.	Adjust the [Clip Server] and [Dir. Path] settings for [Metadata Server] or [File Path]. ( P116 [ Metadata Server ] ) ( P116 [ Clip Server ] )
Server Error.	There was an unintended operation of the FTP server.	Execute again. Use a different server.
Invalid Request.	A bad request is executed for the FTP server.	Execute again.
Invalid Data Size.	Invalid data size, such as a planning metadata size that exceeds 4 KB.	Adjust the planning metadata saved in the [Metadata Server]. ( P147 [ Planning Metadata ] )
Invalid Data Format.	The XML format of the planning metadata is invalid.	Adjust the planning metadata saved in the [Metadata Server]. ( P147 [ Planning Metadata ] )

Error message	Status	Action
Transfer Error.	Transfer failed due to communication failure.	Execute again.
Invalid URL.	The path was deemed invalid by the FTP server.	Adjust the Server and Port settings for [Metadata Server] or [Clip Server]. ( P116 [ Metadata Server ] ) ( P116 [ Clip Server ] )
Media Access Error.	Reading/writing of the SD card failed while FTP transfer is in progress.	Insert a different SD card.
Internal Error.	An internal error has occurred while FTP transfer is in progress.	Adjust the settings and execute again.
Other Error.	An unknown error or other errors have occurred while FTP transfer is in progress.	Adjust the settings and execute again.
Media Read Error.	Reading of the SD card failed while FTP transfer is in progress.	Insert a different SD card.

## Tally Lamp

The tally lamp start blinking when the remaining space on the SD card is running out during recording, or when the battery power is running low.

Blinking Mode	Remaining Battery Power/SD Card Space
Blinks slowly (once every second)	<ul style="list-style-type: none"> <li>Battery power is low</li> <li>Remaining recording time on SD card is less than 3 minutes (during recording)</li> </ul>
Blinks quickly (2 times per second)	<ul style="list-style-type: none"> <li>Remaining recording time on SD card is zero (during recording)</li> <li>Error on the camera recorder</li> </ul>

## Warning Tone

- Warning tone is output from the monitor speaker and [ ] terminal when the battery level is low.
- Warning tone is also output when an error occurs in the camera recorder.

Memo :

- You can specify whether to turn on the warning tone as well as setting the volume in [A/V Set] → [Audio Set] → [Alarm Level].  
( P109 [ Alarm Level ] )

# Troubleshooting

Symptom	Action
Power does not turn on.	<ul style="list-style-type: none"> <li>• Is the AC adapter properly connected?</li> <li>• Is the battery charged?</li> <li>• Is the power turned on immediately after it is turned off? Make sure to wait for an interval of at least 5 seconds before turning on the power again.</li> </ul>
Unable to start recording.	<ul style="list-style-type: none"> <li>• Is the record trigger button/lock switch on the handle turned on?</li> <li>• Is the write-protect switch of the SD card turned on? Make sure that the write-protect switch is turned off. (☞ P39 [Write-Protect Switch on the SD Card] )</li> <li>• Is the camera recorder set to the Camera mode? Use the [MODE] selection button to switch to the Camera mode. (☞ P18 [Operation Modes] )</li> </ul>
Camera image is not output on the LCD monitor and viewfinder screen.	<p>Is the camera recorder set to the Camera mode? Use the [MODE] selection button to switch to the Camera mode. (☞ P18 [Operation Modes] )</p>
Playback does not start after selecting a clip thumbnail and pressing the Set button (●).	<p>Is the selected clip a playable clip? Playback is not possible if the clip has a different video format setting.</p>
No sound during playback.	<p>Is the currently played clip recorded in the Variable Frame Rec mode? (☞ P82 [Variable Frame Rec] )</p>
Images on the LCD monitor and viewfinder screen appear dark or blurred.	<ul style="list-style-type: none"> <li>• Readjust the brightness of the LCD monitor and viewfinder.</li> <li>• Is the [ND FILTER] switch set to "1/64"?</li> <li>• Is the iris closed?</li> <li>• Is the shutter speed setting too high?</li> <li>• Is the amount of peaking too little? Use the [PEAKING +/-] button to adjust the contour for the LCD monitor and the viewfinder screen. (☞ P36 [Adjusting the LCD Monitor] ) (☞ P37 [Adjusting the Viewfinder] )</li> </ul>
The [CH1/CH2] recording level adjustment knob does not work.	<ul style="list-style-type: none"> <li>• Is the [CH1/CH2 AUTO/MANUAL] switch set to "AUTO"?</li> <li>• Is the [FULL AUTO] switch set to "ON"?</li> </ul> <p>Is the [FULL AUTO] switch set to "ON", and [A/V Set] → [Audio Set] → [Audio On FULL AUTO] set to "Auto"? (☞ P109 [ Audio On FULL AUTO ] )</p>
SD card cannot be initialized (formatted).	<p>Is the write-protect switch of the SD card turned on? Make sure that the write-protect switch is turned off. (☞ P39 [Write-Protect Switch on the SD Card] )</p>
Battery alarm appears even after loading a charged battery.	<p>Is the battery too old?</p>



Symptom	Action
The time code and user's bit are not displayed.	<ul style="list-style-type: none"> <li>• Even in Camera mode or Media mode, the time code and user's bit may not be displayed depending to the type of display.</li> <li>• Is [LCD/VF] → [Display Settings] → [TC/UB] set to "Off"? To display the time code and user's bit, set it to "TC" or "UB". (☞ P106 [ TC/UB ] )</li> </ul>
The date and time are not displayed.	<ul style="list-style-type: none"> <li>• The date and time are only displayed on the Display 1 and Display 2 screens in the Camera mode (during shooting). (☞ P121 [Display Screen in Camera Mode] )</li> <li>• Is [System] → [Record Set] → [Time Stamp] set to "On"? To display the date and time, set it to "Off". (☞ P115 [ Time Stamp ] )</li> </ul>
Incorrect display on the viewfinder.	Is the LCD monitor used with [LCD/VF] → [LCD + VF] set to "Off"? (☞ P103 [LCD/VF Menu] )
The actual recording time is shorter than the estimated time.	<ul style="list-style-type: none"> <li>• The recordable time may be shorter depending on the shooting conditions or the subject.</li> </ul>
The two camera recorders are not synchronized even though the time codes have been synchronized. (L on the Slave device is not displayed.)	<ul style="list-style-type: none"> <li>• Is the [TC IN/OUT] switch correctly set? (☞ P68 [Synchronizing Time Code on Another Camera] )</li> <li>• Set [System] → [Record Set] → [Record Format] → [A] Frame &amp; Bit Rate] such that the two camera recorders have the same frame rate. (☞ P112 [ A Frame &amp; Bit Rate ] )</li> </ul>
Cannot connect to wireless LAN.	<ul style="list-style-type: none"> <li>• Check the mode of connection and method of setting ([SSID] and [Passphrase] in cases other than WPS). (☞ P139 [Connecting via Wireless LAN] )</li> <li>• Even if the Passphrase is wrong, "Completed the Setup Wizard. Please Input the Passphrase into Your Device." may appear at the browser setting depending on the type of encryption. Adjust [Passphrase] again.</li> </ul>
The View Remote screen turns black. The screen flickers. The screen freezes. Cannot perform remote operation.	<ul style="list-style-type: none"> <li>• The network path is congested. Wait a while before refreshing (reloading) the web browser.</li> </ul>
The clips cannot be uploaded to the FTP server.	<ul style="list-style-type: none"> <li>• Adjust the [Clip Server] settings. (☞ P116 [ Clip Server ] )</li> <li>• The maximum size of the recorded clip is 4 GB. If a file size limit has been set in the FTP server settings, set the size limit to more than 4 GB.</li> <li>• Take necessary action as described in "[List of FTP Transfer Errors] P 161".</li> </ul>
The wireless LAN is disconnected.	<ul style="list-style-type: none"> <li>• The wireless LAN may be disconnected depending on the environment. Change the usage environment.</li> <li>• Connect via wired LAN. (☞ P141 [Connecting via Wired LAN] )</li> </ul>
GPS signal cannot be received.	<ul style="list-style-type: none"> <li>• Signal reception from GPS satellites may be affected by buildings or trees. Perform positioning preferably at an unobstructed location with a clear view.</li> </ul>
The position is not accurate.	<ul style="list-style-type: none"> <li>• The precision error may be up to hundreds of meters if the GPS signal is weak or reflected off surrounding buildings.</li> </ul>

# Specifications

## General

Item	Description
Power	DC 12 V
Power consumption	Approx. 13.0 W (during recording with backlight set to [STANDARD] while the viewfinder is in use)
Mass	Approx. 2.5 kg (with battery)
Allowable operating temperature	0 °C to 40 °C (32 °F to 104 °F)
Allowable operating humidity	30 %RH to 80 %RH
Allowable storage temperature	-20 °C to 50 °C (-4 °F to 122 °F)

## Terminal Section

Item	Description
[HD/SD SDI] output terminal (480i or 576i: Downconverted 720p/1080i: embedded audio), BNC (unbalanced)	
HD-SDI	Compliant with SMPTE 292 M
SD-SDI	Compliant with SMPTE 259 M
[INPUT1/INPUT2] terminal	
[MIC]	-50 dBu, 3 kΩ, XLR (balanced), +48 V output (phantom power supply)
[LINE]	+4 dBu, 10 kΩ, XLR (balanced)
[AUX] terminal	-22dBu, 10 kΩ, 3.5 mm stereo mini jack (unbalanced)
[AV] terminal	4-pin 3.5 mm mini jack
Video signal	1.0 V (p-p)
Audio signal	-8 dBu (during reference level input), 1 kΩ (unbalanced)
[  ] terminal	3.5 mm mini jack (stereo)
[REMOTE] terminal	2.5 mm mini jack (stereo)
[  ] terminal	
[DEVICE]	Mini USB-B type, USB 2.0, miniB, slave function (mass storage class) only
[HOST]	USB-A type, USB2.0, network connection function only
[TC] terminal	
[IN]	1.0 V(p-p) to 4.0 V(p-p) high impedance
[OUT]	2.0 ± 1.0 V(p-p) low impedance

## Lens Section

Item	Description
Lens	Fujinon F1.6, 23x, f=4.1 mm to 94.3 mm (35 mm conversion: 29 mm to 667 mm)
Filter diameter	Φ72 mm

## Camera Section

Item	Description
Image pickup device	1/3-inch Progressive CMOS
Color separation prism	F1.6, 3-color separation prism
Sync system	Internal sync (built-in SSG)
Optical filter	OFF, 1/4, 1/16, 1/64
Gain	-6dB, -3dB, 0dB, 3dB, 6dB, 9dB, 12dB, 15dB, 18dB, 21dB, 24dB, Lolux (30dB, 36dB), ALC
Electronic shutter	1/6 to 1/10000, EEI
Variable Frame Rate	2/30-60/30fps, 2/25-50/25fps, 2/24-60/24fps
LCD monitor	3.5-inch LCD, 16:9 920K pixels
Viewfinder	0.45-inch LCOS, 1.22M pixels (852 x 480 x 3)

## Storage Section

Item	Description
Supported media	SDHC/SDXC
Slots	x 2

## Video/Audio

Item	Description
Recording time	Approx. 25 minutes (8 GB SD card, 35 Mbps, VBR mode)
HD mode (MOV/MP4/MXF: MPEG-2)	
Video recording file format	QuickTime File Format (For Final Cut Pro)/MP4 File Format/MXF File Format
Video	
HQ mode	MPEG-2 Long GOP VBR, 35 Mbps (Max) MP@HL, 1920x1080/59.94i, 29.97p, 23.98p, 50i, 25p 1440x1080/59.94i, 50i 1280x720/59.94p, 29.97p, 23.98p, 50p, 25p
SP mode	MPEG-2 Long GOP CBR, 18.3 Mbps MP@HL (720p)/25 Mbps MP@H14 (1080i) 1440x1080/59.94i, 50i 1280x720/59.94p, 50p
Audio	LPCM 2ch, 48 kHz/16 Bit
HD mode (AVCHD)	
Video recording file format	AVCHD File Format
Video	
HQ mode	MPEG-4 AVC/H.264, 24 Mbps (Max) 1920x1080/59.94i, 50i
SP mode	MPEG-4 AVC/H.264, 17 Mbps 1920x1080/59.94i, 50i
Audio	Dolby Digital 2ch, 48 kHz/16 Bit, 256 kbps
HD mode (MOV: H.264)	
Video recording file format	QuickTime File Format
Video	MPEG-4 AVC/H.264, 35 Mbps (Max) 1920x1080/59.94i, 23.98p, 50i
Audio	LPCM 2ch, 48 kHz/16 Bit

Item	Description
SD mode (MOV: H.264)	
Video recording file format	QuickTime File Format
Video	MPEG-4 AVC/H.264, 8 Mbps 720x480/59.94i (U model only), 720x576/50i (E model only)
Audio	LPCM 2ch, 48 kHz/16 Bit
Web mode (MOV: H.264)	
Video recording file format	QuickTime File Format
Video	MPEG-4 AVC/H.264, 1.2 Mbps 480x270/29.97p, 23.98p, 25p
Audio	μ-law 2ch, 16 kHz

## Accessories

Accessories	
Warranty Card (U model only)	1
Instructions	1
Document and Software Disc	1
AC Adapter	1
Power Cord (U model: 1, E model: 2)	
Battery	1
AV Cable	1
Clamp Filter	1
Wire Clamp	1
Large Eyecup	1

**Dimensional Outline Drawing (Unit: mm)**

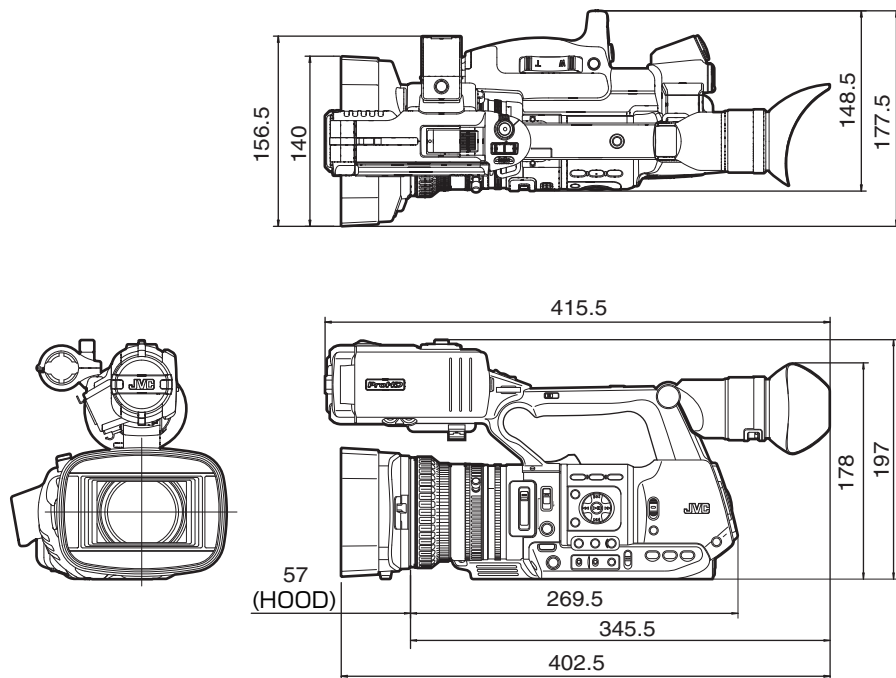

\* The specifications and appearance of this product are subject to changes for further improvement without prior notice.

# Index

- A** AC adapter ..... 29, 30
- Access point ..... 139
- Action ..... 85
- Aspect ratio ..... 46
- Auto power off ..... 31
- B** Backup rec ..... 76
- Battery ..... 15, 28
- Brightness adjustment ..... 51
- C** Camera mode ..... 19, 34, 121
- Charging time ..... 29
- Clip continuous rec ..... 78
- Clip cutter trig (splitting clips) ..... 74
- Clip name ..... 43, 84
- Clip review ..... 72
- Color bar ..... 129
- Color matrix ..... 130
- Computer ..... 134
- Connection settings file ..... 156
- Continuous operating time ..... 29
- D** Deleting clips ..... 87
- Display screen ..... 34, 121, 126
- Dual rec ..... 74
- E** Error message ..... 58, 159
- External monitor ..... 135
- Eyecup ..... 27
- F** Face detection ..... 50
- Favorites menu ..... 117
- File Format ..... 45
- Focus ..... 48
- Focus assist ..... 49
- Formatting (initializing) SD cards ..... 41
- Frame rec ..... 80
- FTP server ..... 142, 86, 144
- G** Gain adjustment ..... 53
- GPS ..... 72, 17, 122
- H** Headphone ..... 63, 137
- I** Image stabilizer ..... 60
- Initial settings ..... 32
- Interval rec ..... 81
- Iris adjustment ..... 52
- L** LCD monitor ..... 17, 30, 34, 36
- Lens cover ..... 28
- M** Marker display ..... 129
- Media mode ..... 19, 34, 126
- Menu ..... 91, 92, 94
- Metadata ..... 142, 147
- N** ND filter ..... 56
- Network ..... 124, 138
- Network operating environment ..... 138
- O** OK mark ..... 88
- One push auto focus ..... 49
- P** P2P ..... 140
- Picture file ..... 131
- Picture quality setting ..... 60
- Power ..... 30, 31
- Pre rec ..... 78
- Preset zoom (browser) ..... 151
- Preset zoom (camera) ..... 48
- Push auto focus ..... 49
- R** Recordable time ..... 39
- Remote edit mode ..... 19, 35
- Resolution ..... 45
- Restoring SD card ..... 42
- S** Safety zone display ..... 129
- Scene file ..... 131
- SD/SDHC/SDXC card ..... 15, 39
- Selecting multiple clips ..... 89
- Setting the date/time ..... 33
- Setup file ..... 131
- Shooting ..... 44
- Skin detail function ..... 129
- Software keyboard ..... 93
- Spot meter ..... 70
- Status screen ..... 35, 128
- Switching shutter mode ..... 54
- Switching shutter speed ..... 54
- T** Tally lamp ..... 38, 162
- Thumbnail (detailed screen) ..... 85
- Thumbnail (standard screen) ..... 83
- Thumbnail screen ..... 83
- Time code ..... 64, 65, 68
- Time code generator ..... 65
- Time code playback ..... 87
- U** USB mode ..... 19, 35, 134
- User button ..... 38
- User's bit ..... 64
- V** Variable frame rec ..... 82

Video format .....	45	Wired remote control .....	137
View remote .....	150	Wireless LAN .....	139
Viewfinder .....	17, 30, 34, 37	<b>Z</b> Zebra pattern .....	69
<b>W</b> Warning .....	35, 162	Zoom .....	47
White balance adjustment .....	56	<b>Symbol</b>	
White paint .....	58	3G adapter .....	141
Wired LAN .....	141		





GY-HM650U/GY-HM650E HD MEMORY CARD CAMERA RECORDER

**JVC**