

# **HD SDI Micro DVR HD Micro DVR**

## **User's Manual**



Version 1.8.8  
2015-01-31

## **CAUTION!!!**

Read this User Manual carefully. There are no user serviceable parts inside. Removing the end plate screws will void your warranty. If your HD Micro DVR requires servicing, please contact your authorized distributor or factory.

**Do not use the 1 Channel HD Micro DVR to power other devices other than a single camera!!**

**If external environment temperature is higher than 35 degree of centigrade & without well convection for cool, please add optional Heat Sink/Mounting for 2/3/4 Channel HD Micro DVR to ensure stability & reliability of device.**

**If external environment temperature is higher than 40 degree of centigrade & without well convection for cool, please add optional Heat Sink/Mounting for 1 Channel HD Micro DVR to ensure stability & reliability of device.**

This document is a work in progress and reflects only the version of the HD Micro DVR device.

# Contents

1. Introduction.....	1
1.1 Introduction of HD SDI Micro DVR .....	1
1.2 Features .....	1
1.3 Product and Accessories .....	2
2. Installation .....	4
2.1 Preparation .....	4
2.1.1 HD Micro DVR Configuration .....	4
2.1.2 PC configuration for replay .....	4
2.2 Installation Guide.....	4
2.2.1 Before Installation.....	4
2.2.2 Installation.....	4
2.2.3 Startup.....	5
2.2.4 Safety and Warning .....	5
2.3 Connect Video Input signal to HD Micro DVR .....	6
2.3.1 HD SDI Micro DVR.....	6
2.4 Video Input and Power Output Interface .....	6
2.5 Button/Bullet Camera Interface .....	7
2.6 Eject SDHC Card .....	7
3. Operation of HD Micro DVR .....	8
3.1 Quick Start.....	8
3.2 Push Button.....	8
3.2.1 RECORD .....	8
3.2.2 STOP.....	9
3.3 LANC Remote Control .....	9
3.4 Power Off/On TFT LCD on HD Micro DVR.....	10
3.5 Video Quality .....	10
3.6 Video File Name .....	11
4. HD Micro DVR Status .....	12
4.1 Status of HD Micro DVR.....	12
4.2 Preview System Information via Shortcut Key.....	12
5. Configure HD Micro DVR.....	14
5.1 Configure HD Micro DVR.....	14
5.1.1 Enter/Quit LCD Configuration Menu .....	14
5.1.2 Configure HD Micro DVR.....	14
5.2 Configuration Menu Details .....	15
5.2.1 VIDEO Setting .....	16
5.2.2 AUDIO Setting .....	17
5.2.3 RECORD Setting.....	18
5.2.4 OSD Setting .....	20
5.2.5 SYSTEM Setting .....	21
5.2.6 REPLAY Setting .....	24

6. Firmware Upgrade .....26  
7. FAQ .....27  
Revision.....28

# 1. Introduction

## 1.1 Introduction of HD SDI Micro DVR

HD SDI HD SDI Micro DVR is a dedicated battery powered Digital Video Recorder designed for portable, mobile Video and Audio Recording applications. The HD SDI Micro DVR hardware system advanced hardware Full-HD 1080p H.264/MPEG-4 video codec, SD/SDHC slot, charging circuit, alarm circuit, video capture, lockable Connect camera/microphone interface and MCU designed on board. The MCU is used to process push buttons, power management, LANC and alarm.

The HD SDI Micro DVR is the unique SDI DVR on the market, which supports any standard HD SDI camera with SDI jump cable. The external SDI camera can even be powered by DVR if the current consumption is under limit. Besides this, a series of quality high sensitivity, low light operation HD SDI bullet camera are also optimized and supplied for the HD SDI DVR for better clarity, accurate color, minimal distortion, smallest size and easy operation.

The recorded video files can be imported to any PC via onboard USB or card reader and replayed. A supplied software ExtremeApp can also import, replay recorded video with future GPS, GoogleMap, G-Force support.

The greatest advantage of SDI camera is fully digital, high quality, low latency, robust video over long distance coaxial cable. It is a best solution for a broad range of business and industrial A/V applications where long distance, high definition video transmission is required, such as machine vision, video conference, education and training etc.

The OS of HD SDI Micro DVR is Linux. It handles multiple tasks in real time, for example; driver, recording, AV synchronization, file management and external events etc.

## 1.2 Features

- ✧ The smallest and lightest HD DVR on the market
- ✧ Support Full HD up to 1080p@24/25/30fps
- ✧ Video Bit Rate up to 12Mbps
- ✧ Support both H.264 and MPEG4 video codec
- ✧ Support frame rate 25fps/30fps and 24fps
- ✧ 5 level gain adjustable Omni-direction microphone
- ✧ Photo Burst mode and Time-Lapse mode
- ✧ Take single, burst and continuous photo

- ✧ Unique LANC remote control interface
- ✧ Battery powered for mobile DVR applications
- ✧ Hot swappable external power or Internal Battery
- ✧ On-board battery external charge circuit
- ✧ Low power consumption up to 90 minute recording
- ✧ Record on removable SDHC Card
- ✧ 2.4" TFT LCD for in field setting and preview
- ✧ Real-time Clock, Time/date stamp and OSD
- ✧ Rugged aluminum housing
- ✧ Optimized HD SDI Bullet Camera with lock connector
- ✧ Rugged aluminum bullet shape housing
- ✧ Camera wearable on head or mount on bars, helmet or vehicle
- ✧ Camera weather proof withstands dust, dirt, mud or rain
- ✧ DVR powered Camera
- ✧ Light weight only 178g with battery and SDHC card
- ✧ upgradeable firmware

### 1.3 Product and Accessories

#### HD SDI Micro DVR

HD SDI Micro DVR	1pcs
AC Power Adapter	1pcs
Recharge Li-ion Polymer Battery (Internal)	1pcs
Multi-Connect/Lockable SDI Adapter Cable	1pcs
YPbPr Video Output Cable	1pcs
External Audio/MIC Input Adapter	1pcs
External Beacon Receiver (Only for Lap Timer Edition)	1pcs
High Sensitivity GPS Antenna (Only for GPS Model)	1pcs

#### HD Micro DVR (HDMI/DVI/VGA/YPbPr/CVBS input)

HD Micro DVR	1pcs
AC Power Adapter	1pcs
Recharge Li-ion Polymer Battery (Internal)	1pcs
HDMI Connection Cable	1pcs
YPbPr Video Output Cable	1pcs
External Audio/MIC Input Adapter	1pcs
External Beacon Receiver (Only for Lap Timer Edition)	1pcs
High Sensitivity GPS Antenna (Only for GPS Model)	1pcs

**\* Power adapter and battery are for HD Micro DVR only and don't use any other power adapter and battery instead in case of damage.**

**\* When you connect AC power adapter to charge internal Li-Ion battery but don't record, please enable Power-Off option to decrease heat of**

***HD Micro DVR & protect HD Micro DVR.***

## 2. Installation

### 2.1 Preparation

Please read user's manual carefully before installation. Check the minimum requirements of system and recommended system configuration.

#### 2.1.1 HD Micro DVR Configuration

- ✓ USB 2.0 Connection Cable
- ✓ SanDisk Class 10 SDHC card, 4GB minimum

#### 2.1.2 PC configuration for replay

- ✓ CPU : Intel i5 2G and above
- ✓ RAM : 2GB and above
- ✓ DVD Recorder : DVD±R/RW
- ✓ OS : Vista, Windows 7 & Windows 8
- ✓ HDD : 7200RPM, 10G free space
- ✓ Display : 1024x768 and above, 24/32 bit color depth
- ✓ Graphic Adapter : Support DirectX 9.0c
- ✓ USB : One free USB 2.0 host interface
- ✓ Card Reader : one high speed USB 2.0/IEEE 1394 card reader

### 2.2 Installation Guide

#### 2.2.1 Before Installation

- 1) Check all accessories and SDHC card
- 2) Format SDHC card with FAT32 file system if it is new
- 3) Check power adapter and battery
- 4) Check whether PC and peripherals match the recommended configuration

#### 2.2.2 Installation

- 1) Make sure power switch is in off position
- 2) Insert SDHC card into SDHC slot on HD Micro DVR
- 3) Connect camera properly
- 4) Connect external microphone or line-in audio input through External Audio/MIC Input Adapter cable if using external audio input source

### 2.2.3 Startup

- 1) Connect AC power adapter
- 2) HD Micro DVR will start self-diagnostics when power on
- 3) The LED is red in self-diagnostics and will turn blue on start-up. The LED turns to green once start-up successful.  
It takes about 12 seconds to startup
- 4) You will hear a beep one time once HD Micro DVR start-up
- 5) The battery will be charged automatically when power on and LED turns on blue

The battery should be fully charged before first use. The charging LED turns on red at once charge finished.

Please charge the internal Li-Ion Polymer battery over night & until the charging LED turns to Blue. Li-ion Polymer rechargeable battery is expendable.

The battery should be replaced after 500 charge cycles. The used battery should be disposed properly.

### 2.2.4 Safety and Warning

***\* Never connect Multi-Connect Cable Power output to any power adapter. It may be damage the interface and board.***

***\* There are no user serviceable parts, please do not open the unit. Doing so can damage the unit and will void your warranty.***

***\* Restrict input voltage to range from 6.5V to 18DC, 12V DC is recommended. Never apply DC voltage beyond this range or AC voltage to the HD SDI Micro DVR.***

***\* Only use AC power adapter supplied with the unit. Do not use third party AC power adapter, it may cause unexpected problems or damage.***

***\* Never insert and remove SDHC card while power is on.***

## 2.3 Connect Video Input signal to HD Micro DVR

### 2.3.1 HD SDI Micro DVR

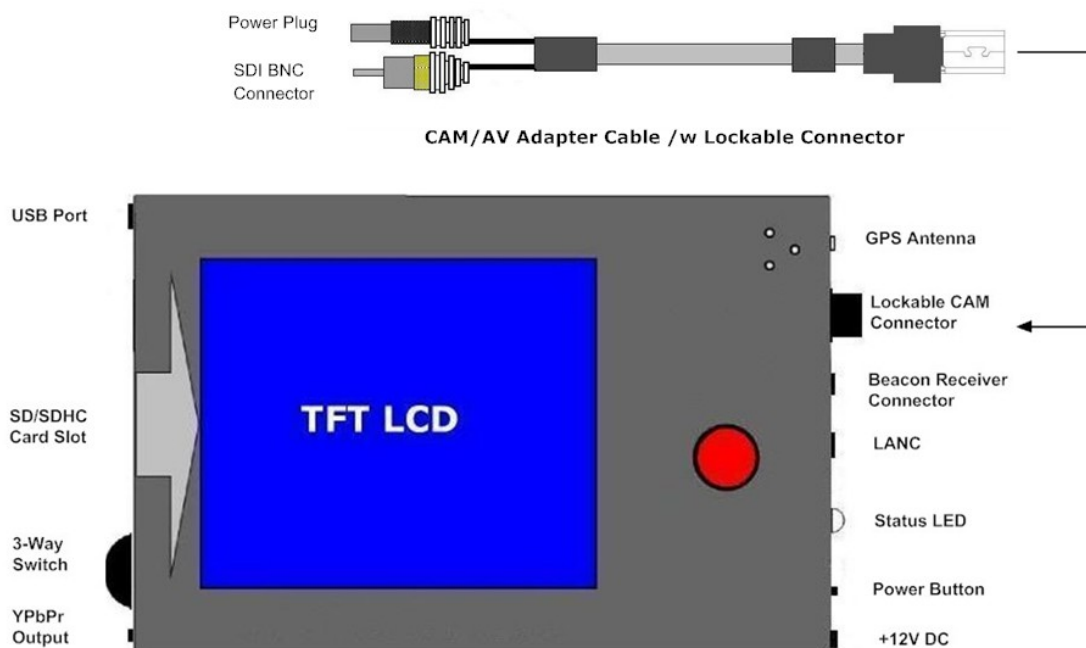

You can preview real-time recording video & adjust angle of view via camera on TFT LCD on HD SDI Micro DVR.

If your HD Micro DVR with lockable connector, please note don't circumgyrate lock connector to avoid connection be disconnected.

Please plug & unplug lock connector cable according to follow scheme!

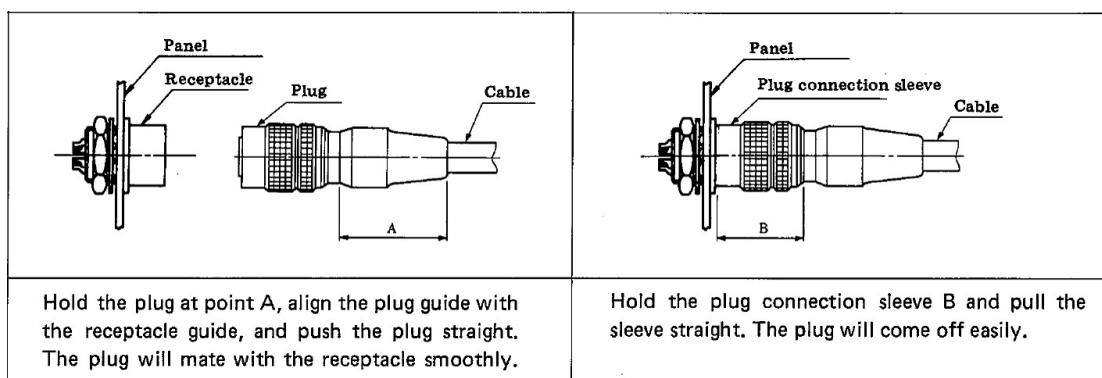

## 2.4 Video Input and Power Output Interface

The HD SDI Micro DVR is configured lockable jump cable with SDI video BNC interface & standard 3.5mm power output plug:

**SDI BNC Connector**  
**3.5mm Power Plug**

SDI Video Input  
Power Output

## **2.5 Button/Bullet Camera Interface**

Some SDI button/bullet cameras can connect to HD SDI Micro DVR directly without the jump cable if the interface of button camera conforms to the lockable connector on DVR.

## **2.6 Eject SDHC Card**

- 1) Wait until the LED turns green
- 2) Disconnect power adapter & Switch off power from the internal battery
- 3) Eject SDHC card

## 3. Operation of HD Micro DVR

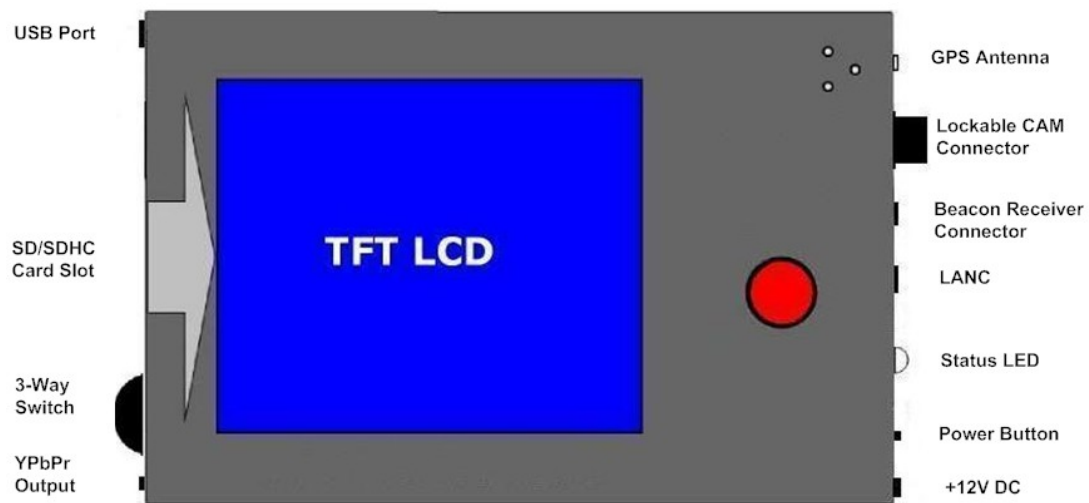

HD SDI Micro DVR

### 3.1 Quick Start

No configuration is required to start recording with the HD Micro DVR.

The operation of the HD Micro DVR is quiet simple. There are two push buttons, REC button and 3-Way switch. An LED is used to indicate the status of operation.

### 3.2 Push Button

#### 3.2.1 RECORD

Press the  (REC) button on top of HD Micro DVR for at least one second to start recording.

The LED will flash blue and you will hear three beeps.

The flash frequency is about 1 times per second. Quickly flash 2 times per second in red means no video signal is connected.

**NOTE : The video input signal must be connected to HD Micro DVR before recording, Lost video signal maybe cause HD Micro DVR with error operation.**

### 3.2.2 STOP

Press the  (STOP) 3-Position button for at least three seconds to stop recording. The LED turns to green & you will hear 2 beeps.

It will take a short while to save buffered data after stopped. The power cannot be turn off until the LED changes to green. Early eject the SDHC card will cause destroy of video file integrity. Disconnect AC power adapter and switch off battery before eject SDHC card.

### 3.3 LANC Remote Control

The HD Micro DVR support multi-version LANC Remote Control, please power off HD Micro DVR & unplug AC Power adapter, then plug LANC remote control into LANC jack with  logo.

**NOTE: SkyTools CameYE SPORT LANC Remote Control V1.4 & V1.6 are supported by the HD SDI Micro DVR.**

Power on the HD Micro DVR, after booting is finished, you can control the HD Micro DVR start/stop recording using LANC remote control. And you can power off HD Micro DVR & power on it again.

After the HD Micro DVR starts successfully, the status LED on LANC remote control will display green. Press the button on the center of LANC to start recording, and the status LED on LANC will flash red & the unit beeps 3 times once started successfully.

Press button again, the HD Micro DVR will stop recording; the status LED on LANC turns to green.

Holding the button on LANC for approx 3 seconds until the status LED on LANC flashes red. This will power down the HD Micro DVR, when the HD Micro DVR powers down, the status LED on LANC turns to yellow.

In power off status, press button on LANC to power up the HD Micro DVR again.

**NOTE: DO NOT PLUG OR UNPLUG LANC REMOTE CONTROL WHEN HD MICRO DVR POWER ON & AC POWER ADAPTER IS CONNECTED!! YOU MUST POWER DOWN THE HD MICRO DVR, UNPLUG AC POWER ADAPTER, THEN PLUG/UNPLUG LANC REMOTE CONTROL.**



### 3.4 Power Off/On TFT LCD on HD Micro DVR

To save the battery power, you can enable the HD Micro DVR TFT LCD off automatically depend on the timer that you set.

The default status of LCD OFF is disabling.

You can enable LCD OFF function & set feat timer under LCD configuration menu.

When you enable **LCD OFF** function & set timer, the TFT LCD on HD Micro DVR will power off automatically at once special timer that you set finish.

To power on TFT LCD again, please hold  button 2 second to power on TFT LCD under normal status; if HD Micro DVR under recording status, please hold  button 2 second to power on TFT LCD again.

### 3.5 Video Quality

HD Micro DVR offer six different video quality for recording, you can select feat video quality that depend on your application or requirement.

The details bitrates & estimated recorded file size of six level video qualities correspond to follow:

Video Quality	Recording Time (minute/GB)	
	720p	1080p
<b>LQ</b>	67min/GB	34min/GB
<b>EP</b>	45min/GB	23min/GB
<b>LP</b>	34min/GB	19min/GB
<b>SP</b>	27min/GB	15min/GB
<b>HQ</b>	23min/GB	12min/GB
<b>UQ</b>	17min/GB	10min/GB

**\* The recorded file size is dependent on the video quality that you select & complexity of movement objects. The recording time those in above table are the approximate value.**

Larger storage cards can yields longer recording time and better video quality. For example, current capacities of SDHC card on the market are from 4~32GB. 4GB SDHC cards can record 4 hours in LQ mode under 720p or 2 hours in LQ

mode under 1080p.

EP mode is recommended for slower moving or still background scene with some moving objects in front. SP mode is recommended for fast moving background scenes.

### 3.6 Video File Name

Video & photo file name starts with **DVR\_** by default.

HD Micro DVR can support standard H.264 and MPEG-4 format video & JPEG picture file.

The file name of video & photo will be **DVR\_XXXX.avi**, **XXXX** is incremental from 0001 to 9999. The file name will array by the create time of file, include video & photo file.

HD Micro DVR will create the directory under DCIM (standard DCF image directory) to storage video & photo, the first default directory is 100HDDVR, when the video & photo files up to 500, system will create next directory 101HDDVR to save new video & photo files, the array will be reduced by analogy, system will create new directory at once current directory with 500 files.

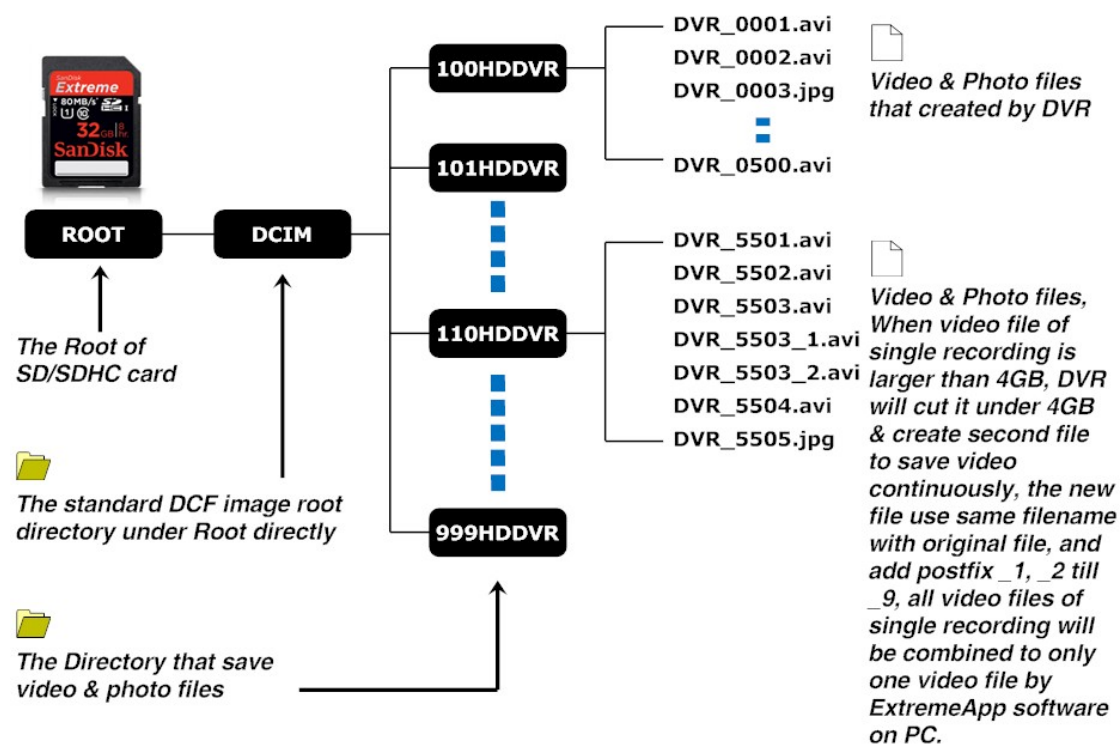

## 4. HD Micro DVR Status

### 4.1 Status of HD Micro DVR

	LED	Beep
<b>DVR Status</b>		
Power On	Red->Blue->Green	0.5s Beep 1 time
Normal	Green	-
Standby	Yellow	0.5s Beep 1 time
Wake Up	Green	0.5s Beep 1 time
Upgrade	Flash Red/Green in 1Hz	2s Beep 1 time
Power Down	Green	1s Beep 1 time
Charge when Power off	Blue in charging Red after charging fully	
<b>Recording</b>		
Recording	Flash Blue in 1Hz; Flash Red if battery less than 20%	1Hz Beep 3 times
Stop Recording	Green	1Hz Beep 2 times
Lost Video Signal	Flash Red in 0.5Hz	
No Card or Card Full	Red	1s Beep 1 time
<b>Photo</b>		
Photo Once	Flash Blue in 0.5s 1 time	0.5s Beep 1 time
Photo Continuously	Flash Blue in 1Hz; Flash Red if battery less than 20%	1Hz Beep 3 times
Stop Photo	Green	1Hz Beep 2 times
No Card or Card Full	Red	1s Beep 1 time
Lost Video Signal	Flash Red in 0.5Hz	

### 4.2 Preview System Information via Shortcut Key

When HD Micro DVR starts successfully, LCD will display some information on screen. Include current date/time, power off timer, G-Force, GPS & battery status on upper on screen, and display current video input, recording format, resolution & fps of recording video, video quality, audio input source & gain on bottom of screen.

And you can turn  3-Way switch to UP/DOWN to preview system information of HD Micro DVR.

### **Confirm MediDVR Current Status**

Under normal status, press the **UP** and **DOWN** buttons to display HD Micro DVR current status.

Press **UP** button to display:

- Hardware Version
- Bootloader Version
- Firmware Version

Press **DOWN** button to display free space of SDHC card.

- Free Space 2.48G

## 5. Configure HD Micro DVR

### 5.1 Configure HD Micro DVR

#### 5.1.1 Enter/Quit LCD Configuration Menu

Hold push the  3-Position button at least 3 seconds to enter LCD configuration menu, once you enter LCD configuration menu successfully, the LCD will display valid menu/menu item & parameter of these menu item depend on the details of your HD Micro DVR model.

After finish configuration, press  button to quit to upper menu.





You may need press  button one or two times once depend on your position in menu.

Once you enter the LCD configuration menu, the system will wait for you to select & configure, if you don't press any buttons, the system will quit the LCD configuration menu after 10 sec automatically.

After you finish setting, you can hold  button at least 3 seconds to exit setting menu, or you can wait 10 seconds without any operation to exit setting menu automatically.



#### 5.1.2 Configure HD Micro DVR





You can configure HD Micro DVR in LCD menu via push switch/button.

1. Once you enter LCD configuration menu, you can switch menu using **DOWN & UP** position of  3-Way switch, then press  button to select the menu which you want to configure.
2. Press  button switch item that you want to configure in current setting menu.
3. Using **DOWN & UP** position of  3-Way pull menu item and select the

parameter value that you want, and then press  button to save the configuration.

4. Press  button to switch label to **Exit** button on the bottom of screen when you finish current menu setting.

If current menu include more screen, press  button to switch label to **Next** button and press  button to entry second screen of current menu.

5. Press  button to quit to upper menu interface.
6. Switch to next menu that you want to configure using **DOWN & UP** position of  3-Way switch, then press  button to select the menu which you want to configure.
7. After you finish setting, you can hold  button at least 3 seconds to exit setting menu, or you can wait 10 seconds without any operation to exit setting menu automatically.

**NOTE : DVR will restarting automatically when some item be changed.**

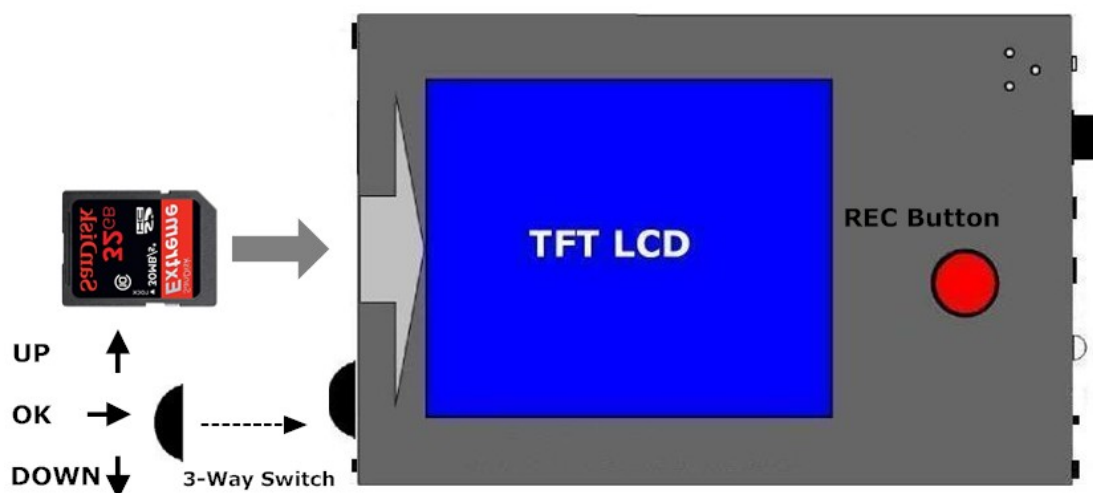

The Sketch Map of Button

## 5.2 Configuration Menu Details

Configure HD Micro DVR in setting menu for the best performance based on different application & scene.

- **VIDEO**

- **AUDIO**
- **RECORD**
- **OSD**
- **SYSTEM**
- **REPLAY**

The blue parameter is default settings; you can change it by yourself.

### 5.2.1 VIDEO Setting

Use **VIDEO** menu to set follow items:

Menu Item	Instruction
<b><u>Source</u></b>	Select the video input source (SDI, HDMI, DVI, etc.). * <b>SDI</b> is only valid option for HD SDI Micro DVR.
<b><u>Resolution</u></b>	Set correct resolution of current video input source.
<b><u>System</u></b>	Select feat video system depends on your local TV/Video system, and you can select Movie 24 system if you want to record Full HD 1080p film movie.
<b><u>Format</u></b>	You can select different encode format depend on your requirement: MPEG-4 or H.264. When you select Photo format, HD Micro DVR will entry Photo mode, you can shoot photos and create the time lapse video.
<b><u>Signal</u></b>	Select video signal input method. * HD Micro DVR can detect input video signal, recommend select Auto detect when set correct video input interface * If input video signal with special setting, can set input video signal manually

Valid parameters of Menu Items:

Item	Parameter
Source	- SDI
Resolution	- 1080p - 1080i - 720p - 576i - 480i
System	- 30/60 - 25/50 - 24
Format	- H.264 - MPEG-4 - PHOTO
Signal	- Auto - Manual

### Detect Video Input Signal Automatically

Commonly, we recommend select **Auto** option for input video signal, HD Micro DVR will detect & set input video signal automatically based on details input signal, it is suit most input video signal.

For some video signal, it maybe with some special or nonstandard parameter, Auto detect function maybe can't offer the best setting, please select **Manual** option under **VIDEO / Signal** menu & set input video signal manually.

### 5.2.2 AUDIO Setting

Use **AUDIO** menu to set follow items:

Menu Item	Instruction
<b><u>Source</u></b>	Select the audio input source.
<b><u>Gain</u></b>	Set gain level for current input audio source.
<b><u>Audio</u></b>	Enable or Mute audio for recording.

Valid parameters of Menu Items:

Item	Parameter
Source	- Line In - Ext. MIC

	- Int. MIC
Gain	- High - Normal - Low - Lower
Audio	- Enable - Mute

The default Audio source is internal microphone onboard, you can switch it to Line or Ext MIC if you use line-in audio input or external microphone. You can connect line-in audio input or external microphone to HD Micro DVR through External Audio Adapter Cable with HD Micro DVR.

### 5.2.3 RECORD Setting

Use **RECORD** menu to set follow items:

Menu Item	Instruction
<b><u>Quality</u></b>	Select recording video quality.
<b><u>Bitrate</u></b>	Depend on different scene & object, you can select different decode rate control: CBR or VBR. * We recommend you select VBR mode when you recording for the best video quality & performance.
<b><u>Trigger</u></b>	Select feat start method for recording video.
<b><u>Mode</u></b>	Set storage method for recording video. * For normal application, set Normal mode, DVR will storage recording video continuously until SDHC card without free space. * For surveillance, recommend set to Cycle mode, DVR will storage recording video continuously until all space is used, and then system will overwrite the oldest file & recording continuously.
<b><u>Burst</u></b>	You can select photo number when you shoot once.

**Interval**

The Photo Interval set interval time between twice photo, it is valid only you set Video Format to Photo mode, and Quality & Rate Control items will be ignore.

**FileNum**

Reset files number of recording video.

Valid parameters of Menu Items:

<b>Item</b>	<b>Parameter</b>
Quality	- UQ - HQ - SP - LP - EP - LQ
Bitrate	- VBR - CBR
Trigger	- Normal - Motion - Car Mode - Power Up
Mode	- Normal - Cycle
Burst	- 1 - 3 - 5 - 10
Interval	- 2 Sec - 5 Sec - 10 Sec - 30 Sec - 60 Sec
FileNum	Reset

**Burst & Interval**

**Burst & Interval** are only valid for PHOTO mode; you can set HD Micro DVR to PHOTO mode in **VIDEO / Format** menu.

The setting of Burst & Interval will be ignored under recording video mode.

**Recording Trigger**

Select feat start method for recording video from triggers supported by HD

Micro DVR:

- **Normal**                      Start & Stop recording by button or LANC remote controller manually.
  
- **Motion**                      - When HD Micro DVR detect motion object, it will start recording;  
    - When DVR detect no motion object in special region, system will stop recording & storage recording video.
  
- **Car Mode**                    It is design for vehicle application.  
    - When HD Micro DVR detect vehicle turn on, DVR will start recording automatically;  
    - When HD Micro DVR detect vehicle turn off, DVR will stop recording automatically.  
    ※ HD Micro DVR need power by optional Car Cigarette Lighter Adapter.
  
- **Power Up**                    In some applications, you may need the HD Micro DVR to record automatically once the DVR is powered on.  
    You need stop recording manually still.

If you want to time the recording file from DVR\_0001, please reset File Number

**Reset Number for Filename of Recording Video**

If you want to time the recording file from DVR\_0001, please reset File Number item.

When you select Reset option under **FileNum** option, DVR will prompt you; at once you select **YES** option, DVR will reset filename to begin from DVR\_0001. Select **NO** option if you wouldn't do it.

**5.2.4 OSD Setting**

Use **OSD** menu to set follow items:

Menu Item	Instruction
<b><u>Stamp</u></b>	Display Date/Time stamp on screen or no. * Default, current date & time will be record in recording video, you can disable it.

**Position** The default display position of Time Stamp is Top Left, the customized OSD information will display on other side by same level if you enable it.

**Custom** If you want to display your customized OSD information, you can enable it & input in **String** submenu.

**String** Input custom OSD string for display as stamp.

Valid parameters of Menu Items:

Item	Parameter
Stamp	- Enable - Disable
Position	- Top Left - Top Right - Bottom Left - Bottom Right
Custom	- Disable - Enable
String	(OSD)

### Custom OSD String

To set custom OSD string, select **String** sub menu & enter, label will locate the first character, use the **UP** and **DOWN** buttons to switch character, press the **OK** button confirm it, label will switch to next character for setting, and so on. Press **OK** button when you finish setting of OSD string.

- ※ The custom OSD string support maximum 12 characters.
- ※ When you finish custom OSD string & quit setting menu, HD Micro DVR will restart to effect new OSD string, system will display prompt message on screen:

**Restart to make setting take effect...**

## 5.2.5 SYSTEM Setting

Use **SYSTEM** menu to set follow items:

Menu Item	Instruction
<b><u>CAM Volt</u></b>	HD SDI Micro DVR can power external HD

SDI bullet camera, you can set output voltage from DVR depend on your HD SDI camera.

**Power Off**

For save battery, you can power off DVR when without any operation, you can set different timer.

**LCD Off**

For save battery, you can close LCD when without any operation, you can set different timer.

**LCD Flip**

When you clip HD Micro DVR to waistband using buckle, or clip DVR on arm, maybe the screen of HD Micro DVR is reversed, you can flip LCD to view screen correctly.

**Beep**

Enable or disable beep on HD Micro DVR when you operate HD Micro DVR or recording.

**DateTime**

Set correct data & time in first when you get your HD Micro DVR.

**Language**

Select language of display & setting menu.

**LapTimer**

Enable LapTimer function when you connect optional LapTimer upgrade set.

**Factory**

Sometimes, if you want to recover HD Micro DVR setting to default & set it by yourself again, you can recover configuration to factory default by select Recovery item.

Valid parameters of Menu Items:

Item	Parameter
Cam Volt	<ul style="list-style-type: none"> <li>- 18VQ</li> <li>- 12V</li> <li>- 9V</li> <li>- 6.5V</li> <li>- 5V</li> </ul>
Power Off	<ul style="list-style-type: none"> <li>- Disable</li> <li>- 1 Min</li> </ul>

	- 5 Min - 10 Min - 15 Min
LCD Off	- Normal - 15 Sec - 30 Sec - 60 Sec
LCD Flip	- Disable - Enable
Beep	- Enable - Disable
DateTime	2015-02-01 12:00
Language	- English
LapTimer	- OFF - ON
Factory	Recovery

## Set Date & Time

Set correct data & time in first when you get your HD Micro DVR.

To set date & time, select **DateTime** sub menu & enter, label will locate the first area, use the **UP** and **DOWN** buttons to switch value, press the **OK** button confirm it, label will switch to next area for setting, and so on.

Press **OK** button when you finish setting of date & time.

※ When you finish date & time setting & quit setting menu, HD Micro DVR will restart to effect new date & time, system will display prompt message on screen:

**Restart to make setting take effect...**

## Lap Timer

Lap Timer function is design for racing, you can record every loop time, total time of racing, and you can record driver name, team, and circuit for racing, make & model of vehicle in racing on screen of recording video.

At once you enable Lap Timer function, the Lap Timer data will be recorded on recording video & separate text data file, always, but you can select display it on screen of recording video, please disable On Screen Display option.

※ You can connect optional Lap Timer upgrade set to HD Micro DVR for Lap Timer function.

※ The Lap Timer Upgrade Set is sold separately.

## Recovery DVR Setting to Factory Default

Sometimes, if you want to recover HD Micro DVR setting to default & set it by yourself again, you can recover configuration to factory default by select Recovery item.

When you select **Recovery** option, system will prompt "**YES**" or "**NO**" on screen.

- If you want to reset settings, use the **UP** and **DOWN** buttons to select "**YES**", and then press the **OK** button to restore settings.
- If you want not to reset settings, use the **UP** and **DOWN** buttons to select "**NO**", and then press the **OK** button, system will quit to submenu & keep current settings of device.

※ **Recovery setting to factory default will lost all your own setting.**

## 5.2.6 REPLAY Setting

Use **REPLAY** menu to set follow items:

Menu Item	Instruction
<b><u>Start</u></b>	Start replay recording video on SDHC card.
<b><u>Output</u></b>	Select output device for replay.
<b><u>File</u></b>	Delete all files on SDHC card to empty free space of SDHC to storage new recording video.

Valid parameters of Menu Items:

Item	Parameter
Start	<i>Replay</i>
Output	- LCD - YPbPr
File	<i>Delete All</i>

### Start Replay Recording Video

At once you select **Replay** option in **Start** sub menu, HD Micro DVR will restart & enter replay mode.

System will display prompt message on screen:

**Please connect the video to replay...**

After restart finished, LCD or external monitor that connect to HD Micro DVR through YPbPr connection will display all recording videos on SDHC card, use **UP** & **DOWN** button to select video that you want to replay, press OK button to replay it, press **OK** button again to stop replay.

During replay, use **UP** or **DOWN** button to switch to previous or next recording video.

※ Current HD Micro DVR support replay H.264 video directly only.

### **Select Display Device for Replay**

HD Micro DVR support replay recording video on built-in LCD or external monitor through YPbPr video output connection.

### **Delete All Files**

After you review recording videos, you can delete all files on SDHC card to empty free space on SDHC card to storage new recording videos.

When you select **Delete All** option, system will prompt "**YES**" or "**NO**" on screen.

- If you want to delete all files, use the **UP** and **DOWN** buttons to select "**YES**", and then press the **OK** button to delete all files.
- If you want not to delete files, use the **UP** and **DOWN** buttons to select "**NO**", and then press the **OK** button, system will quit to submenu & keep all files on SDHC card.

## 6. Firmware Upgrade

**NOTE: Please don't connect camera & other external device to HD Micro DVR when you upgrade HD Micro DVR!**

The firmware of the HD Micro DVR can be upgraded if necessary. The HD Micro DVR will check the core image file on SDHC card while power up. If image & OSD file is found then the firmware of the HD Micro DVR will be upgraded automatically. Please follow below instructions to upgrade.

- 1) Format SDHC card in FAT32 file system.
- 2) Copy uImage.bin & cramfs.bin files to the root of SDHC card.
- 3) Power off and then insert SDHC card into HD Micro DVR.
- 4) Turn on the power of HD Micro DVR.
- 5) The firmware will be upgraded after power on. Beep will sound once in 2 seconds to prompt upgrading, and the LED switch between red & green in 1Hz.

At the same time, LCD will display schedule of prompt message of upgrade process.

When the HD Micro DVR upgrades successfully, it will reboot automatically.

**\* DON'T TURN OFF POWER DURING THIS PERIOD!!**

- 6) The HD Micro DVR will prompt you power off DVR & power on again after upgrade.  
The LED will change to red, blue and then green during HD Micro DVR power on again. It takes about 12 seconds to reboot.
- 7) Over if the LED is green. A Beep will sound one time once the HD Micro DVR upgrades successfully.

**\* Power supply has to be guaranteed normal while upgrading. HD Micro DVR can not be restored if upgrade fails.**

**\* Wait at least 4-5 minutes till reboot successful. LED keeps constant green if reboot successful.**

## 7. FAQ

1) Charging period

It takes 5-8 hours to charge a fully discharged battery. The charge indicator LED will go out once fully charged.

2) File is not accessible or HD Micro DVR can't startup

File system is wrong. This can happen after abnormal power off and long time usages of SDHC card. Format SDHC card in FAT32 file system.

3) HD Micro DVR is hot when it on recording & recharge

When you record video & recharge HD Micro DVR at the same time, it maybe become hot because recharge bring large quantity of heat, overheating maybe cause HD Micro DVR faulty.

If external environment temperature is higher than 40 degree of centigrade & without well convection for cool, please add optional Heat Sink/Mounting for HD Micro DVR to ensure stability & reliability of DVR.

## **Revision**

### **2015-01-30, Version 1.8.8**

- Add detect input video signal automatically
- Add replay function
- Add OSD function
- Add recovery factory setting function
- Add PHOTO mode
- Add recording trigger
- Add cycle recording mode
- Improve system stability

### **2013-08-01, Version 1.0.0**

- Initial Release