

**NEC**

Projector

# NP4000

---

User's Manual



- DLP is a registered trademark of Texas Instruments. BrilliantColor and DynamicBlack are trademarks of Texas Instruments.
- IBM is a trademark or registered trademark of International Business Machines Corporation.
- Macintosh, Mac OS X and PowerBook are trademarks of Apple, Inc., registered in the U.S. and other countries.
- Windows, Windows 98, Windows Me, Windows XP or Windows 2000 are trademarks or registered trademarks of Microsoft Corporation.
- Trademark PJLink is a trademark applied for trademark rights in Japan, the United States of America and other countries and areas.
- Other product and company names mentioned in this user's manual may be the trademarks or registered trademarks of their respective holders.

## **Notes**

- (1) The contents of this user's manual may not be reprinted in part or whole without permission.
- (2) The contents of this user's manual are subject to change without notice.
- (3) Great care has been taken in the preparation of this user's manual; however, should you notice any questionable points, errors or omissions, please contact us.
- (4) Notwithstanding article (3), NEC will not be responsible for any claims on loss of profit or other matters deemed to result from using the Projector.

# Important Information

---

## Safety Cautions

### Precautions

Please read this manual carefully before using your NEC NP4000 projector and keep the manual handy for future reference. Your serial number is located on the bottom of your projector.

Record it here:



**CAUTION:**

To turn off main power, be sure to remove the plug from power outlet. The power outlet socket should be installed as near to the equipment as possible, and should be easily accessible.



**CAUTION:**

- TO PREVENT SHOCK, DO NOT OPEN THE CABINET.
- THERE ARE HIGH-VOLTAGE COMPONENTS INSIDE.
- REFER SERVICING TO QUALIFIED SERVICE PERSONNEL.



This symbol warns the user that un-insulated voltage within the unit may be sufficient to cause electrical shock. Therefore, it is dangerous to make any kind of contact with any part inside of the unit.



This symbol alerts the user that important information concerning the operation and maintenance of this unit has been provided.

The information should be read carefully to avoid problems.

**WARNING:**

*To prevent fire or shock, do NOT expose this unit to rain or moisture. Do NOT use this unit's plug with an extension cord or in an outlet unless all the prongs can be fully inserted.*

### DOC Compliance Notice (for Canada only)

This Class B digital apparatus meets all requirements of the Canadian Interference-Causing Equipment Regulations.

### Machine Noise Information Regulation - 3. GPSGV (for Germany only)

The highest sound pressure level is less than 70 dB (A) in accordance with EN ISO 7779.

## Important Information

### Laser Rating



This label is on the side of the remote control.

This mark is on the top of the remote control.

#### CAUTION



Use of controls or adjustments or performance of procedures other than those specified herein may result in hazardous radiation exposure.

#### CAUTION



Do not look into the laser pointer while it is on and do not point the laser beam at a person. Serious injury could result.

### Disposing of your used product



EU-wide legislation as implemented in each Member State requires that used electrical and electronic products carrying the mark (left) must be disposed of separately from normal household waste. This includes projectors and their electrical accessories or lamps. When you dispose of such products, please follow the guidance of your local authority and/or ask the shop where you purchased the product. After collecting the used products, they are reused and recycled in a proper way. This effort will help us reduce the wastes as well as the negative impact such as mercury contained in a lamp to the human health and the environment at the minimum level. The mark on the electrical and electronic products only applies to the current European Union Member States.

### WARNING TO CALIFORNIA RESIDENTS:

Handling the cables supplied with this product will expose you to lead, a chemical known to the State of California to cause birth defects or other reproductive harm. Wash hands after handling.

### **RF Interference (for USA only)**

#### **WARNING:**

*The Federal Communications Commission does not allow any modifications or changes to the unit EXCEPT those specified by NEC Display Solutions of America, Inc. in this manual. Failure to comply with this government regulation could void your right to operate this equipment. This equipment has been tested and found to comply with the limits for a Class B digital device, pursuant to Part 15 of the FCC Rules. These limits are designed to provide reasonable protection against harmful interference in a residential installation. This equipment generates, uses, and can radiate radio frequency energy and, if not installed and used in accordance with the instructions, may cause harmful interference to radio communications. However, there is no guarantee that interference will not occur in a particular installation.*

*If this equipment does cause harmful interference to radio or television reception, which can be determined by turning the equipment off and on, the user is encouraged to try to correct the interference by one or more of the following measures:*

- *Reorient or relocate the receiving antenna.*
- *Increase the separation between the equipment and receiver.*
- *Connect the equipment into an outlet on a circuit different from that to which the receiver is connected.*
- *Consult the dealer or an experienced radio / TV technician for help.*

For UK only: In UK, a BS approved power cable with molded plug has a Black (five Amps) fuse installed for use with this equipment. If a power cable is not supplied with this equipment please contact your supplier.

### **Important Safeguards**

These safety instructions are to ensure the long life of your projector and to prevent fire and shock. Please read them carefully and heed all warnings.



#### **Installation**

- Do not place the projector in the following conditions:
  - On an unstable cart, stand, or table.
  - Near water, baths or damp rooms.
  - In direct sunlight, near heaters or heat radiating appliances.
  - In a dusty, smoky or steamy environment.
  - On a sheet of paper or cloth, rugs or carpets.

## Important Information

---

- If you wish to have the projector installed on the ceiling:
  - Do not attempt to install the projector yourself.
  - The projector must be installed by qualified technicians in order to ensure proper operation and reduce the risk of bodily injury.
  - In addition, the ceiling must be strong enough to support the projector and the installation must be in accordance with any local building codes.
  - Please consult your dealer for more information.



### CAUTION:

When shipping the projector, remove the optional lens beforehand. The lens and the lens shift mechanism may encounter damage caused by improper handling during transportation.

### *Place the projector in a horizontal position*

The tilt angle of the projector should not exceed 10 degrees, nor should the projector be installed in any way other than the desktop and ceiling mount, otherwise lamp life could decrease dramatically.

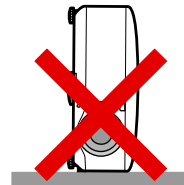

### CAUTION:

Do not drop the projector on your hand or fingers while lifting the projector to replace the filters. Doing so could injure your hand or fingers.



### ***Fire and Shock Precautions***



- Ensure that there is sufficient ventilation and that vents are unobstructed to prevent the build-up of heat inside your projector. Allow at least 8 inches (20cm) of space between your projector and a wall.
- Do not try to touch the ventilation outlet on the **rear** as it can become heated while the projector is turned on and immediately after the projector is turned off.
- Prevent foreign objects such as paper clips and bits of paper from falling into your projector. Do not attempt to retrieve any objects that might fall into your projector. Do not insert any metal objects such as a wire or screwdriver into your project. If something should fall into your projector, disconnect it immediately and have the object removed by qualified service personnel.
- Do not place any objects on top of the projector.
- Do not touch the power plug during a thunderstorm. Doing so can cause electrical shock or fire.
- The projector is designed to operate on a power supply of 100-240V AC 50/60 Hz. Ensure that your power supply fits this requirement before attempting to use your projector.
- Do not look into the lens while the projector is on. Serious damage to your eyes could result.
- Keep any items such as magnifying glass out of the light path of the projector. The light being projected from the lens is extensive, therefore any kind of abnormal objects that can redirect light coming out of the lens, can cause unpredictable outcome such as fire or injury to the eyes.
- Do not cover the lens with the black lens cap or equivalent while the projector is on. Doing so can lead to melting of the cap and possibly burning your hands due to the heat emitted from the light output.
- Do not place any objects, which are easily affected by heat, in front of the projector lens or a projector exhaust vent. Doing so could lead to the object melting or getting your hands burned from the heat that is emitted from the light output and exhaust.
- Handle the power cable carefully. A damaged or frayed power cable can cause electric shock or fire.
  - Do not use any power cables other than the one supplied by NEC.
  - Do not bend or tug the power cable excessively.
  - Do not place the power cable under the projector, or any heavy object.
  - Do not cover the power cable with other soft materials such as rugs.
  - Do not heat the power cable
  - Do not handle the power plug with wet hands.

## Important Information

---

- Turn off the projector, unplug the power cable and have the projector serviced by qualified service personnel under the following conditions:
  - When the power cable or plug is damaged or frayed.
  - If liquid has been spilled into the projector, or if it has been exposed to rain or water.
  - If the projector does not operate normally when you follow the instructions described in this user's manual.
  - If the projector has been dropped or the cabinet has been damaged.
  - If the projector exhibits a distinct change in performance, indicating a need for service.
- Disconnect the power cable and any other cables before carrying the projector.
- Turn off the projector and unplug the power cable if the projector is not to be used for an extended period of time.
- When using a LAN cable:
  - For safety, do not connect to the connector for peripheral device wiring that might have excessive voltage.
- Turn off the projector and unplug the power cable before cleaning the cabinet or replacing the lamp.

### CAUTION:



- Always carry your projector by using the carrying handle.
- Do not use the tilt-foot for purposes other than originally intended. Misuses such as using the tilt foot to carry or hang (from the wall or ceiling) the projector can cause damage to the projector.
- Do not send the projector in the soft case by parcel delivery service or cargo shipment. The projector inside the soft case could be damaged.
- If heavy use for a number of consecutive days is expected, select the High setting in the Fan Mode window to reduce heat stress on the projector (see Fan Mode).
- Do not unplug the power cable from the wall outlet or projector when the projector is powered on. Doing so can cause damage to the AC IN connector of the projector and (or) the prong plug of the power cable.
- To turn off the AC power supply when the projector is powered on, use a power strip equipped with a switch and a breaker.
- The projector can be unplugged during its cool down period after it is turned off.
- Do not try to touch the ventilation outlet on the rear as it can become heated while the projector is turned on and immediately after the projector is turned off.
- Do not turn off the AC power for 60 seconds after the lamp is turned on and while the POWER indicator is blinking green. Doing so could cause premature lamp failure.
- Do not place your hands near the lens opening while shifting the lens. Shifting the lens could pinch your fingers or hands causing injury.



### **Remote Control Precautions**

- Handle the remote control carefully.
- If the remote control gets wet, wipe it dry immediately.
- Avoid excessive heat and humidity.
- Do not heat, take apart, or throw batteries into fire.
- If you will not be using the remote control for a long time, remove the batteries.
- Ensure that you have the batteries' polarity (+/-) aligned correctly.
- Do not use new and old batteries together, or use different types of batteries together.
- Dispose of used batteries according to your local regulations.

### **Lamp Replacement**

To replace either of the lamps, follow all instructions provided on page 99.

Be sure to replace the lamp when the following is displayed on the screen:

**The lamp has reached the end of its usable life.  
Please replace the lamp.**

If you continue to use the lamp after the lamp has reached the end of its usable life, the lamp bulb may shatter, and pieces of glass may be scattered in the lamp case. Do not touch them as the pieces of glass may cause injury.

If this happens, contact your dealer for lamp replacement.

### **Important Lamp Characteristic**

The projector has a high-pressure mercury lamp as a light source.

A characteristic of mercury lamps is that brightness gradually decreases with age. Also repeatedly turning the lamp on and off will increase the possibility of reduced brightness.



#### **CAUTION:**

When removing the lamp from a ceiling-mounted projector, make sure that no one is under the projector. Glass fragments could fall if the lamp has been burned out.

# Table of Contents

---

<b>IMPORTANT INFORMATION.....</b>	<b>I</b>
SAFETY CAUTIONS.....	I
<b>TABLE OF CONTENTS .....</b>	<b>VIII</b>
<b>1. INTRODUCTION .....</b>	<b>1</b>
❶ WHAT'S IN THE BOX? .....	1
❷ INTRODUCTION TO THE PROJECTOR.....	2
<i>Features you'll enjoy:</i> .....	2
❸ PART NAMES OF THE PROJECTOR.....	3
<i>Front-right view</i> .....	3
<i>Top View</i> .....	4
<i>Carrying the Projector</i> .....	5
<i>Bottom view</i> .....	6
❹ TOP FEATURES.....	7
<i>Lens Controls</i> .....	7
<i>OSD Controls and Status LEDs</i> .....	8
❺ TERMINAL PANEL FEATURES .....	10
❻ PART NAMES OF THE REMOTE CONTROL.....	12
<i>Battery Installation</i> .....	14
<i>Operating Range for Wireless Remote Control</i> .....	15
<i>Remote Control Precautions</i> .....	15
<i>Using the Remote Control in Wired Operation</i> .....	16
<b>2. INSTALLATION AND CONNECTIONS.....</b>	<b>17</b>
❶ SETTING UP THE SCREEN AND THE PROJECTOR.....	17
❷ SELECTING A LOCATION.....	18
❸ INSTALLING OR REMOVING THE OPTIONAL LENS .....	19
<i>Removing the Existing Lens From the Projector</i> .....	19
<i>Installing the New Lens</i> .....	21
<i>Installing the New Lens Using the anti-theft screw</i> .....	22
❹ THROW DISTANCE AND SCREEN SIZE .....	23
❺ REPLACING COLOR WHEEL .....	25
❻ MAKING CONNECTIONS.....	28
<i>Connecting Your PC or Macintosh Computer</i> .....	28
<i>Connecting an External Monitor</i> .....	30
<i>Connecting Your DVD Player with Component Output</i> .....	31
<i>Connecting Your VCR or Laser Disc Player</i> .....	32
❼ CONNECTING THE SUPPLIED POWER CABLE .....	33
<b>3. PROJECTING AN IMAGE (BASIC OPERATION) .....</b>	<b>34</b>
❶ TURNING ON THE PROJECTOR.....	34
<i>Note on Startup Screen (Menu Language Select screen)</i> .....	35
❷ SELECTING A SOURCE .....	36
❸ ADJUSTING THE PICTURE POSITION AND PICTURE SIZE.....	37
<i>Adjusting Picture Position Manually</i> .....	37
<i>Lens Shift Adjustable Range</i> .....	38

## Table of Contents

<i>From the Remote Control Unit</i> .....	39
<i>Adjusting the Projector Level</i> .....	40
④ OPTIMIZING AN RGB IMAGE AUTOMATICALLY .....	41
<i>Adjusting the Image Using Auto Adjust</i> .....	41
⑤ ADJUSTING VOLUME UP AND DOWN .....	42
⑥ TURNING OFF THE PROJECTOR .....	43
<i>About Direct Power Off</i> .....	44
<i>After Use</i> .....	44
<b>4. CONVENIENT FEATURES</b> .....	<b>45</b>
① TURNING OFF THE IMAGE AND SOUND .....	45
② FREEZING A PICTURE .....	45
③ ADJUSTING THE FOCUS/ZOOM MANUALLY .....	46
<i>Adjusting by Using the OSD Control Panel</i> .....	46
④ CHANGING LAMP MODE .....	47
<i>Changing Lamp Mode by Using the Projector's OSD Control Panel</i> .....	47
<i>Changing Lamp Mode by Using the Remote Control</i> .....	48
⑤ GETTING INFORMATION .....	49
⑥ ADJUSTING POSITION/CLOCK .....	50
<i>Adjusting Position/Clock/Phase by Using the OSD Control Panel</i> .....	50
<i>Correcting Keystone by Using the Remote Control</i> .....	51
⑦ PREVENTING THE UNAUTHORIZED USE OF THE PROJECTOR .....	53
<i>Locking the Projector</i> .....	53
<i>Unlocking the Projector</i> .....	55
⑧ USING THE PHYSICAL LOCK .....	56
<i>Using the Kensington Lock</i> .....	56
<i>Using the Security Chain Lock</i> .....	56
<b>5. USING ON-SCREEN DISPLAY</b> .....	<b>57</b>
① USING THE MENUS .....	57
<i>Navigating the OSD</i> .....	57
② MENU TREE .....	59
③ MENU ELEMENTS .....	61
④ SOURCE MENU DESCRIPTIONS AND FUNCTIONS .....	62
⑤ ADJUST MENU DESCRIPTIONS AND FUNCTIONS .....	63
<i>Picture menu</i> .....	63
<i>Image Options Menu</i> .....	64
<i>Video Menu</i> .....	66
⑥ DETAIL SETTINGS MENU DESCRIPTIONS AND FUNCTIONS .....	69
<i>General</i> .....	69
<i>White Balance</i> .....	71
<i>Color Correction</i> .....	72
⑦ SETUP MENU DESCRIPTIONS AND FUNCTIONS .....	73
<i>General</i> .....	73
<i>Installation</i> .....	77
<i>LAN Settings</i> .....	84
<i>Options</i> .....	85
⑧ INFORMATION MENU DESCRIPTIONS AND FUNCTIONS .....	89
<i>Usage Time</i> .....	89
<i>Source</i> .....	90
<i>LAN</i> .....	91

## Table of Contents

---

Version.....	92
⑨ RESET MENU DESCRIPTIONS AND FUNCTIONS .....	93
<b>6. MAINTENANCE.....</b>	<b>94</b>
① CLEANING THE PROJECTOR .....	94
<i>Cleaning the Cabinet</i> .....	94
<i>Cleaning the Lens</i> .....	94
<i>Cleaning the Filters</i> .....	95
② REPLACING CONSUMABLE PARTS .....	97
<i>Replacing the Filters</i> .....	97
<i>Replacing the Lamps</i> .....	99
<i>Resetting the Lamp Hours Counter</i> .....	101
<b>7. APPENDIX.....</b>	<b>102</b>
① USING THE OPTIONAL REMOTE MOUSE RECEIVER (NP01MR).....	102
<i>Connecting the remote mouse receiver to your computer</i> .....	102
<i>When operating a computer through the remote mouse receiver</i> .....	102
<i>When connecting using the USB terminal</i> .....	103
<i>Operating your computer's mouse from the remote control</i> .....	103
<i>About Drag Mode</i> .....	103
② TROUBLESHOOTING .....	104
<i>Indicator Messages</i> .....	104
<i>Common Problems and Solutions</i> .....	106
<i>Tips for Troubleshooting</i> .....	106
③ IMAGE PROBLEMS .....	107
<i>Lamp Problems</i> .....	107
<i>Remote Control Problems</i> .....	108
<i>Audio Problems</i> .....	108
④ HAVING THE PROJECTOR SERVICED .....	109
<b>8. SPECIFICATIONS.....</b>	<b>110</b>
① PROJECTOR SPECIFICATIONS .....	110
<i>Optical Specifications</i> .....	110
<i>Electrical Specifications</i> .....	111
<i>Mechanical Specifications</i> .....	112
<i>Environmental Considerations</i> .....	112
<i>Regulations</i> .....	113
② CABINET DIMENSIONS .....	114
③ PIN ASSIGNMENTS OF MINI D-SUB 15 PIN INPUT CONNECTOR .....	115
④ COMPATIBLE INPUT SIGNAL LIST .....	116
⑤ PC CONTROL CODES AND CABLE CONNECTIONS .....	118
⑥ SCREEN TRIGGER .....	120
⑦ OPERATION USING HTTP BROWSER .....	121
<i>Overview</i> .....	121
<i>Preparation Before Use</i> .....	121
<i>Handling of the Address for Operation via a Browser</i> .....	121
<i>Configuring Network Settings</i> .....	122
<i>Structure of the HTTP Server</i> .....	124
⑧ 15 PIN GPIO CONTROL.....	126
<b>9. TROUBLESHOOTING CHECK LIST.....</b>	<b>127</b>

# 1. Introduction

## 1 What's in the Box?

Carefully unpack the projector and check that the following items are included:

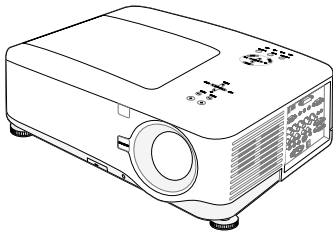

NP4000 Projector

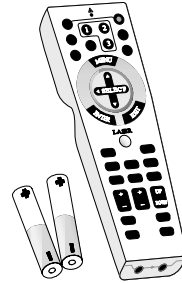

Remote Control  
(with Two AA alkaline batteries)

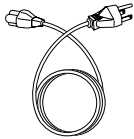

Power cable  
(3.6m/11.8 ft.)  
For North America,  
Europe and  
Japan



Remote Cable  
(10m/33ft)

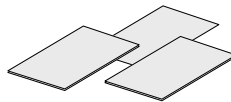

- Quick start guide
- Important Information
- (For North America Only) Registration Card
- Limited Warranty
- (For Europe only) Guarantee Policy
- (For Japan Only) User's manual
- Warranty card



CD-ROM  
(This User's manual)

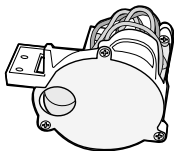

6 Segment Color  
Wheel



Lens Hole Cap  
(Installed)

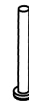

- Anti-Theft Screw for lens x 1
- Security Sticker

Contact your dealer immediately if any items are missing, appear damaged, or if the unit does not work.

### CAUTION



Avoid using the projector in dusty environments.

## 1. Introduction

---

### ② Introduction to the Projector

#### *Features you'll enjoy:*

- DLP projector with high resolution
- High brightness  
High brightness output of 5000 lumens (4-segment color wheel).
- Dual Lamp system  
Two lamp system offers increased lamp life and energy savings along with redundancy.
- Extensive optional lens with bayonet mount  
Five types of optional lenses are available.
- Powered Lens Shift, Zoom, and Focus offer installation flexibility  
Powered Horizontal and Vertical lens shift provides the ability to project from off center screen installations. Powered zoom and focus provide quick and easy adjustment.
- Direct Power Off & Auto Start  
The projector has a feature called "Direct Power Off". This feature allows the projector to be turned off (even when projecting an image) using a power strip equipped with a switch and a breaker.

#### **Note:**

*Before using Direct Power Off, be sure to allow at least 20 minutes immediately after turning on the projector and starting to display an image. Also, the power cable can be removed immediately after turning off the projector. Auto Start eliminates the need to always use the POWER (ON/STANDBY) button on the remote control or projector cabinet.*

- A variety of input ports and a comprehensive array of system control interfaces  
This projector supports input signals including BNC, DVI-D, analog RGB, component, S-video, and composite.
- 3W+3W Stereo speaker  
Built in 3W x 2 speakers are provided.
- Preventing unauthorized use of the projector  
Enhanced smart security settings for password protection, cabinet control panel lock to help prevent unauthorized access, adjustments and theft deterrence.
- Integrated RJ-45 connector for wired networking capability for property management.
- Combination of BrilliantColor™ and 6-segment color wheel offers a more true color reproduction

### 3 Part Names of the Projector

*Front-right view*

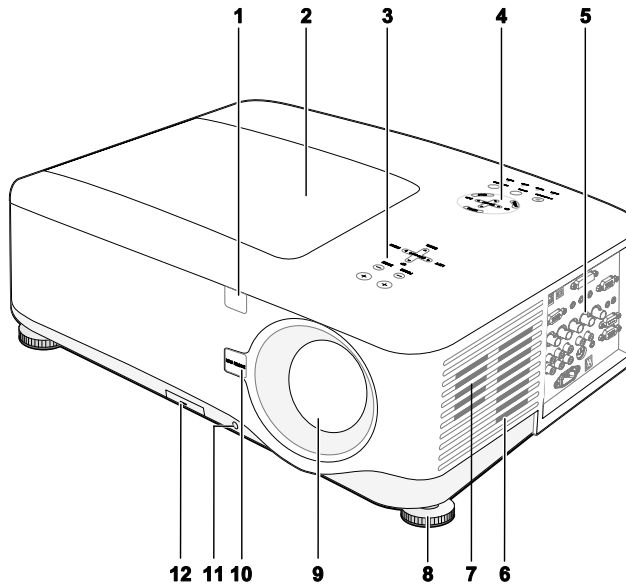

ITEM	LABEL	DESCRIPTION	SEE PAGE:
1.	IR receiver	Receiver for IR signal from remote control	12
2.	Lamp cover	Remove cover to replace lamp or color wheel	99
3.	Lens control panel	See Lens Controls	7
4.	OSD control panel	See OSD Controls and Status LEDs	8
5.	I/O connector panel	Connect various input devices	10
6.	Intake vent	Lamp cooling vent – do not obstruct	—
7.	Speakers	Built-in stereo speakers	—
8.	Height adjuster	Adjusts level of projector	6
9.	Lens	Remove lens hole cap before use	—
10.	Lens release button	Press the release button before removing the lens	—
11.	Anti-Theft Screw	Prevent theft of the lens	—
12.	Intake vent and front filter	Keeps the front fan free of dust – clean regularly for optimum performance – do not obstruct	95

**Important:**

Grill openings on the projector allow for good air circulation, which keeps the projector lamp cool. Do not obstruct any of the grill openings.

## 1. Introduction

### Top View

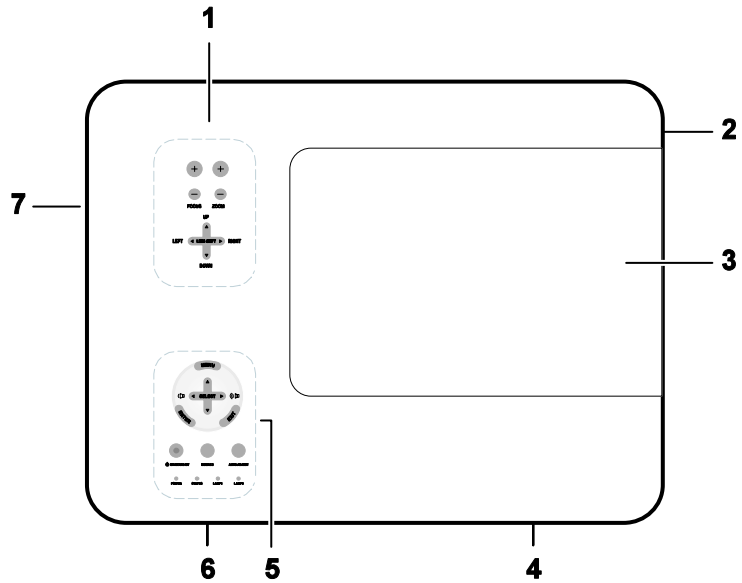

ITEM	LABEL	DESCRIPTION	SEE PAGE:
1.	Lens control panel	See Lens Controls	7
2.	Right-hand speaker	Right-hand speaker	—
3.	Lamp cover	Remove cover to replace lamp or color wheel	99
4.	Exhaust vent	Exhaust vent – do not obstruct	—
5.	OSD control panel	See OSD Controls and Status LEDS	8
6.	Rear intake vent	Rear cooling intake – do not obstruct	—
7.	Left intake vent	Left-hand cooling intake – do not obstruct	—

### Carrying the Projector

Always carry your projector by the handle.

Before moving or carrying the projector, disconnect the power cable and any other cables that may be attached to it.

When moving the projector or when the projector is not in use, cover the lens with the lens cap.

To extend the projector handle, refer to the following guide.

1. Stand the projector on its end with the control panels at the bottom.

**Note:**

*Stand the projector on its end by lifting the cabinet. Do not use the handle to place the projector upright.*

2. Lift the handle in the direction shown until it is fully extended.

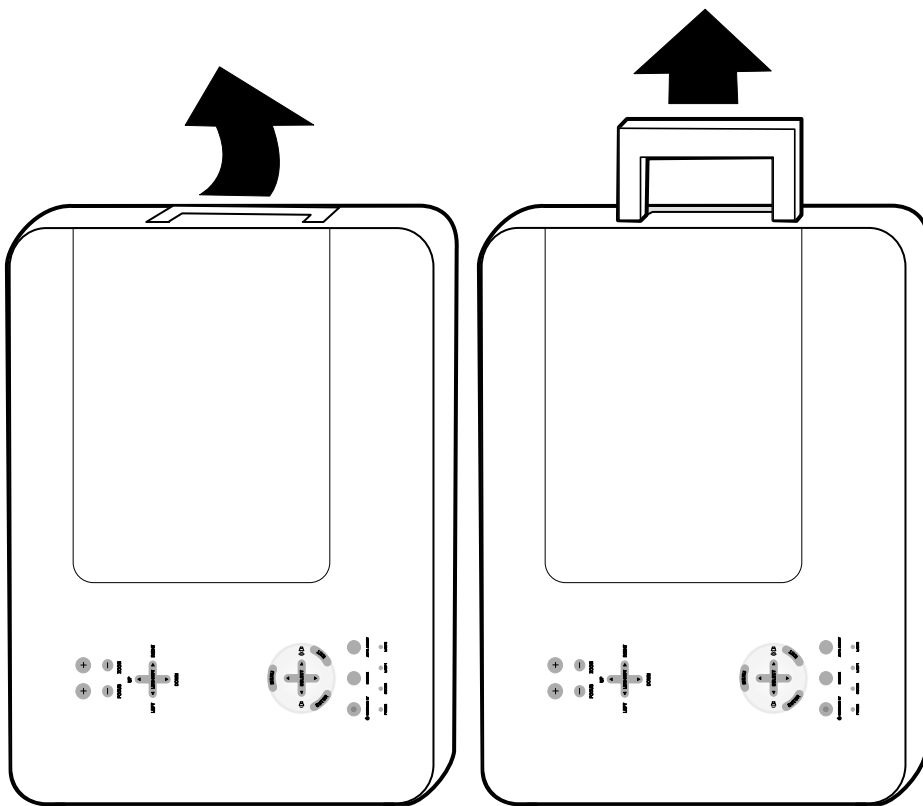

## 1. Introduction

### Bottom view

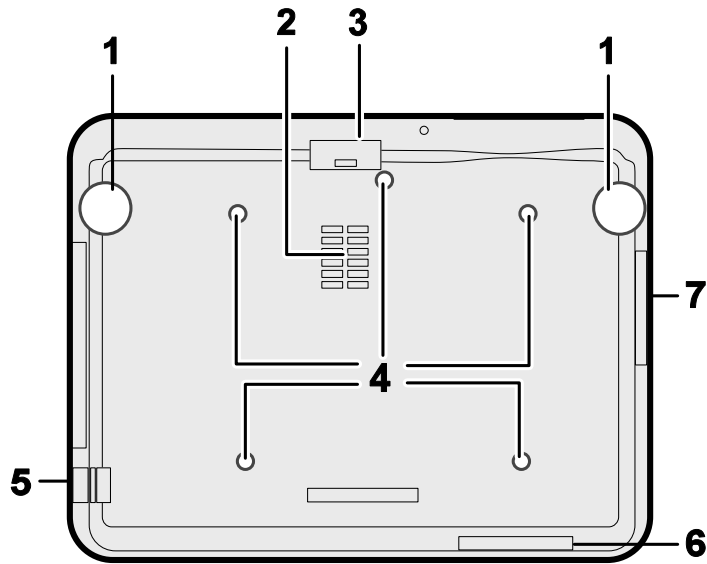

ITEM	LABEL	DESCRIPTION	SEE PAGE:
1.	Height adjusters	Adjust projection height	40
2.	Intake vent	Color wheel cooling vent – do not obstruct	—
3.	Front filter	Keep the fan free of dust – clean regularly for optimum performance	95
4.	Ceiling support holes	Contact your dealer for information on mounting the projector on a ceiling	—
5.	Security chain opening	Attach anti-theft device – see ⑧ Using the Physical Lock	56
6.	Rear filter	Keep the fans free of dust – clean regularly for optimum performance	95
7.	Side filter		

#### CAUTION



With ceiling installation, use approved mounting hardware & M4 screws; maximum depth of screw: 12mm; distance from ceiling/ wall: 50/50 cm, 20/20 inch for proper ventilation; distance from fluorescent lamps: at least 50 cm front and back of then projector. For permanent installations, follow local codes.

4 Top Features

*Lens Controls*

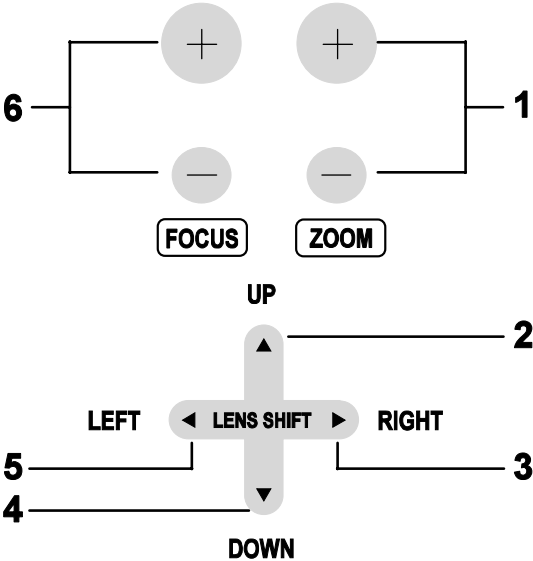

ITEM	LABEL	DESCRIPTION	SEE PAGE:
1.	ZOOM	Increase/decrease projected image size	46
2.	UP CURSOR	Move image left, right, up, or down	
3.	RIGHT CURSOR		
4.	DOWN CURSOR		
5.	LEFT CURSOR		
6.	FOCUS	Focus the projected image	46

## 1. Introduction

### OSD Controls and Status LEDs

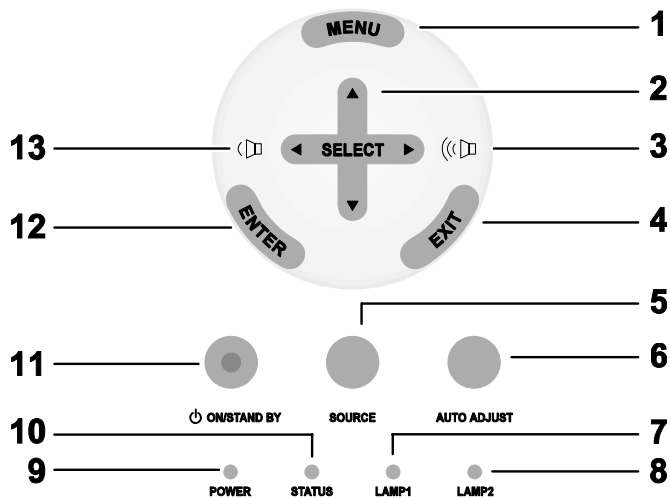

ITEM	LABEL	DESCRIPTION	SEE PAGE:	
1.	MENU	Open / Close the OSD	57	
2.	SELECT PAD	Navigate and change settings in the OSD	57	
3.	RIGHT CURSOR/ VOLUME INCREASE	Increase volume	42	
4.	EXIT	Exit the On-Screen Display (OSD)	57	
5.	SOURCE	Change or select the input device	36	
6.	AUTO ADJUST	Optimize image size, position, and resolution	41	
7.	LAMP 1	Green	See Indicator Messages	104
		Flashing		

ITEM	LABEL	DESCRIPTION		SEE PAGE:
8.	LAMP 2	Green	See Indicator Messages	<i>104</i>
		Flashing		
9.	POWER (LED)	Green	See Indicator Messages	<i>104</i>
		Orange		
		Flashing		
10.	STATUS (LED)	Green	Lamp ready—you can safely turn on or off the projector	<i>104</i>
11.	POWER	Turn the projector on or off (main power switch must be turned on first)		<i>10</i>
12.	ENTER	Select or change settings in the OSD		<i>57</i>
13.	LEFT CURSOR/VOLUME DECREASE	Decrease volume		<i>42</i>

## 1. Introduction

### 5 Terminal Panel Features

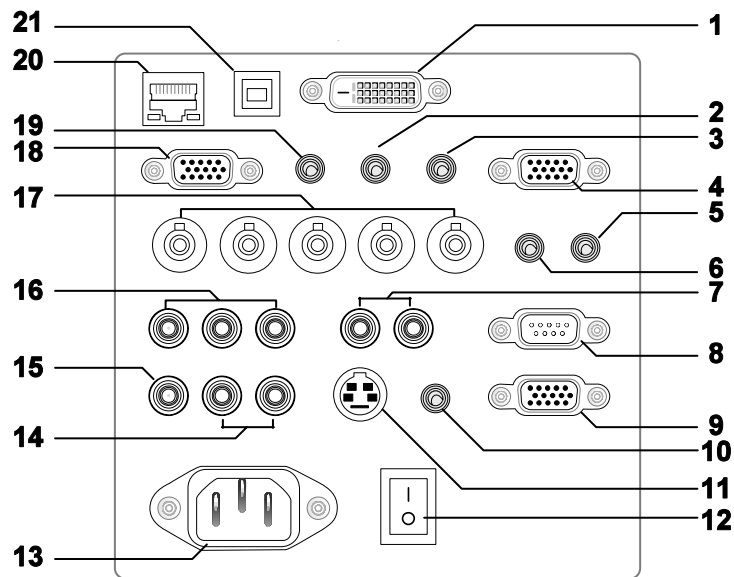

ITEM	LABEL	DESCRIPTION	SEE PAGE:
1.	COMPUTER 3 IN	Connect the DVI cable (not supplied) from a computer	28
2.	AUDIO IN (3)	Connect the audio cable (not supplied) from the input device	—
3.	AUDIO OUT	Audio loop-thru	—
4.	MONITOR OUT	Connect to a monitor	—
5.	REMOTE 2	Connect the remote to the projector	15
6.	AUDIO IN (2)	Connect the audio cable (not supplied) from the input device	—
7.	L/MONO, R (COMPONENT)	Connect an RCA audio cables (not supplied) from the input device right and left channels	—
8.	PC CONTROL	Installation control	120
9.	REMOTE 1	For external control	120

## 1. Introduction

ITEM	LABEL	DESCRIPTION	SEE PAGE:
10.	SC TRIGGER	When connected to the screen through a commercially available cable, the screen deploys automatically on start up of the projector. The screen retracts when the projector is powered off (see notes below)	120
11.	S-VIDEO	Connect a commercially available S-video cable from a video device	31
12.	POWER SWITCH	Turn on/off the projector	43
13.	AC IN	Connect the supplied power cable	33
14.	L/MONO, R	Connect RCA audio cables (not supplied) from the input device right and left channels. This audio jack is shared with S-Video input.	—
15.	VIDEO IN	Connect a composite video cable (not supplied) from a video device to the yellow RCA jack	32
16.	COMPONENT IN (Y, Cb/Pb, Cr/Pr)	Connect a component video enabled device	32
17.	COMPUTER 2 IN (R/Cr, G/Y, B/Cb, H, V)	Connect RGBHV or Component signal from computer or component video enabled device	32
18.	COMPUTER 1 IN	Connect a VGA cable (not supplied) from a computer	28
19.	AUDIO IN (1)	Connect the audio cable (not supplied) from the input device	—
20.	LAN	Connect a LAN cable (not supplied) from a computer	28
21.	SERVICE	Connect the USB cable (not supplied) from a computer. For service personnel only.	—

**Note:**

- To use this feature, you must turn on the Screen Trigger function on OSD.
- Screen controllers are supplied and supported by screen manufacturers.
- Do not use this jack for anything other than intended use. Connecting the wired remote control to the Trigger mini jack causes damage to the remote control.

## 1. Introduction

### ⑥ Part Names of the Remote Control

The Remote Control unit supplied with the projector combines ergonomic design and utility and includes features such as Volume and Zoom Control, Freeze Frame and a useful pointing tool in the form of a laser. Refer to the following diagram and table for button location and functionality.

ITEM	LABEL		LABEL	ITEM
1.	Remote jack		Exit button	18.
2.	Laser pointer		Laser button	19.
3.	Infrared transmitter		L-Click button	20.
4.	LED		R-Click button	21.
5.	Power OFF button*		Focus/ Zoom button	22.
6.	Power ON button**		Freeze button	23.
7.	Computer 1 button		Lens shift button	24.
8.	Computer 2 button		Aspect button	25.
9.	Video button		Lamp mode button	26.
10.	Viewer button (The VIEWER and PAGE buttons will work with the other models, which have a Viewer function. NP4000 does not have this function.)		Auto ADJ. button	27.
11.	Component button		Volume buttons	28.
12.	Computer 3 button		Magnify buttons	29.
13.	S-Video button		Page Up/Down buttons (The VIEWER and PAGE buttons will work with the other models, which have a Viewer function. NP4000 does not have this function.)	30.
14.	LAN button (Not available on NP4000)		Picture button	31.
15.	Menu button		Keystone button	32.
16.	Select ▲▼◀▶ button		PIC-Mute button	33.
17.	Enter button		Help button	34.

**Important:**

1. *Avoid using the projector with bright fluorescent lighting turned on. Certain high-frequency fluorescent lights can disrupt remote control operation.*
2. *Be sure nothing obstructs the path between the remote control and the projector. If the path between remote and projector is obstructed, you can bounce the remote signal off certain reflective surfaces such as projector screens.*
3. *The buttons and keys on the projector have the same functions as the corresponding buttons on the remote control. This user's manual describes the functions based on the remote control.*

**Note:**

*\*To turn off the projector, press the **Power OFF** button twice.*

*\*\*To turn on the projector, press and hold the **Power On** button for a minimum of two seconds*

## 1. Introduction

---

### Battery Installation

The Remote Control unit included with the projector does not contain batteries, though batteries are supplied as part of the complete package. To insert (or replace) the batteries, refer to the following guide.

1. Remove the battery compartment cover by squeezing the locking catch (A) and sliding the cover in the direction of the arrow (B).

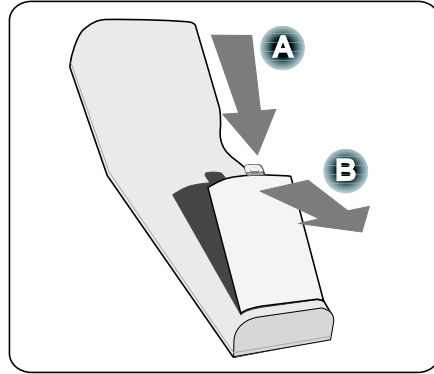

2. Insert the supplied batteries taking note of the polarity (+/-) as shown.

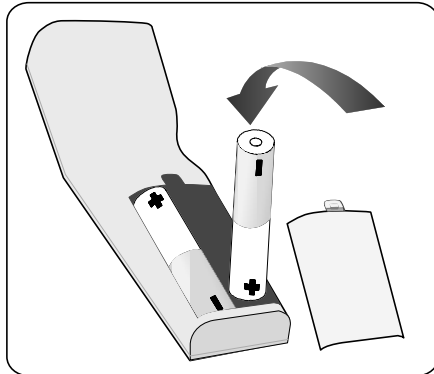

3. Replace the cover locator (A), and then click locking catch into place (B).

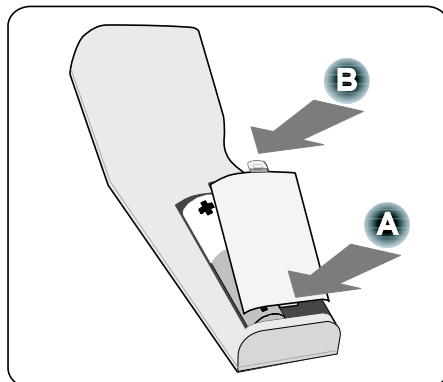

### Operating Range for Wireless Remote Control

The infrared signal operates by line-of-sight up to a distance of about 22 feet (7m) and within a 60-degree angle of the remote sensor on the projector cabinet.

The projector will not respond if there are objects between the remote control and the sensor, or if strong light falls on the sensor. Weak batteries will also prevent the remote control from properly operating the projector.

### Remote Control Precautions

The following precautions ensure that the remote operates correctly and safely.

- Handle the remote control carefully.
- If the remote control gets wet, wipe it dry immediately.
- Avoid excessive heat and humidity.
- Do not heat, take apart, or throw batteries into fire.
- For extended periods of inactivity, remove the batteries.
- Ensure that the batteries' polarity (+/-) aligned correctly.
- Do not use new and old batteries together, or different types of batteries together.
- Dispose of used batteries according to local regulations.

## 1. Introduction

---

### *Using the Remote Control in Wired Operation*

Connect the supplied remote cable to the REMOTE2 jack on the projector (see 5 Terminal Panel Features on page 10) and the other end to the remote jack on the remote control (see item 1, 6 Part Names of the Remote Control on page 12).

**Note:**

*Connecting the remote cable to the REMOTE2 jack on the terminal panel will make the wireless operation unavailable.*

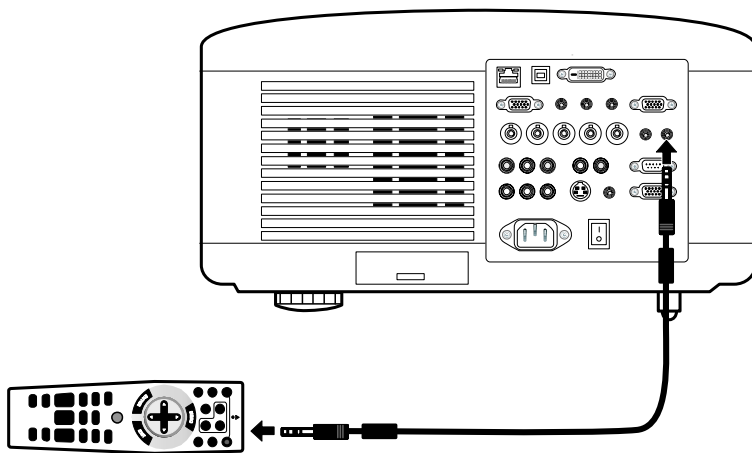

## 2. Installation and Connections

---

### 1 Setting Up the Screen and the Projector

This section briefly describes how to set up your projector and how to connect video and audio sources.

Your projector is simple to set up and use. But before you get started, you must first:

- Set up a screen and the projector.
- Connect your computer or video equipment to the projector. See 6 Making Connections on page 28.
- Connect the supplied power cable. See 7 Connecting the Supplied Power Cable on page 33.

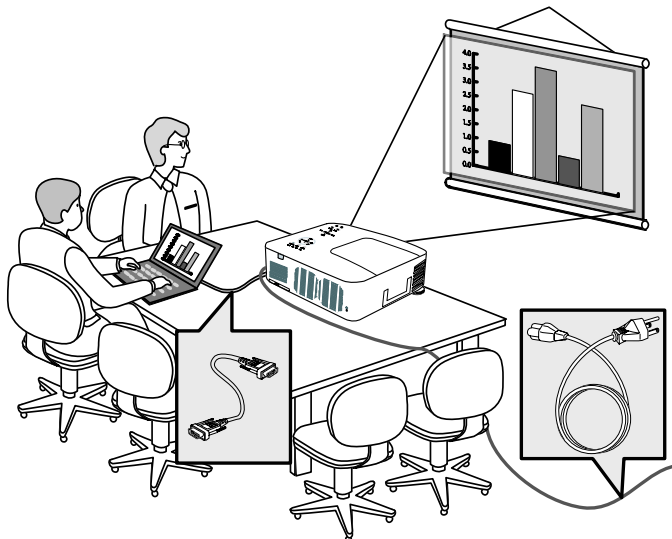

**Note:**

*Ensure that the power cable and any other cables are disconnected before moving the projector. When moving the projector or when it is not in use, cover the lens with the lens cap.*

## 2. Installation and Connections

### ② Selecting a Location

Locating the projector correctly ensures optimum performance and a longer parts life.

Take note of the following when setting up the projector:

- The projector table or stand should be level and sturdy.
- Position the projector so that it is perpendicular to the screen.
- Ensure cables do not cause a trip hazard.

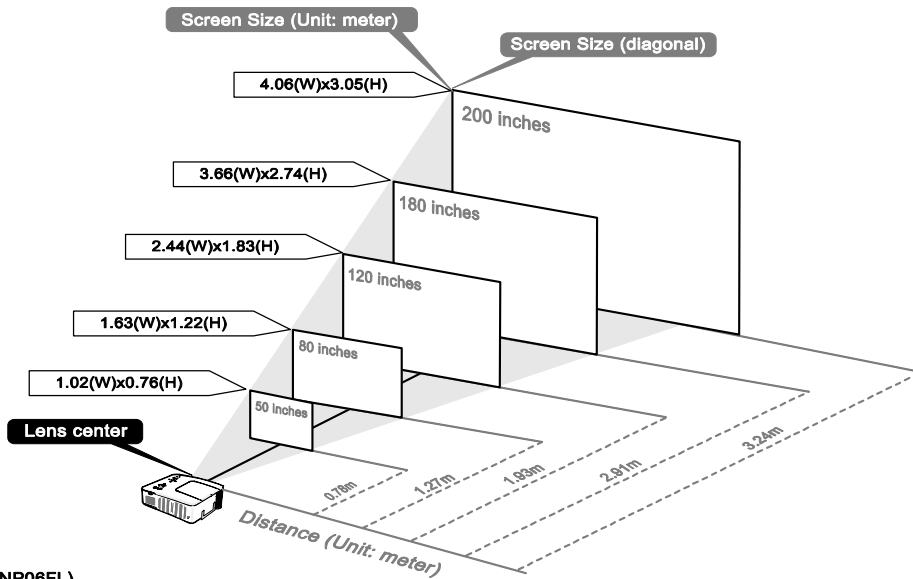

(Reference: NP06FL)

### ③ Installing or Removing the Optional Lens

**CAUTION:**



- Do not shake or place excessive pressure on the projector or the lens components as the projector and lens components contain precision parts.
- When shipping the projector with the optional lens, remove the optional lens before shipping the projector. The lens and the lens shift mechanism may encounter damage caused by improper handling during transportation.
- Before removing or installing the lens, be sure to turn off the projector, wait until the cooling fans stop, and turn off the main power switch.
- Do not touch the lens surface when removing or installing the lens.
- Keep fingerprints, dust or oil off the lens surface. Do not scratch the lens surface.
- Work on a level surface with a soft cloth under it to avoid scratching.
- If you remove and store the lens, attach the lens cap to the projector to keep off dust and dirt.

#### Removing the Existing Lens From the Projector

1. Pull out the lens cap.

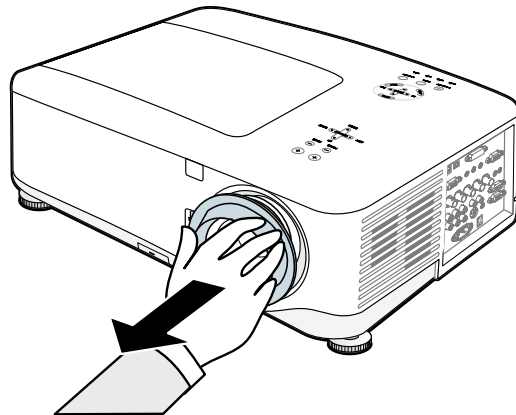

## 2. Installation and Connections

---

2. Push the LENS RELEASE button all the way in and rotate the lens counterclockwise. The existing lens will be disengaged.

**Note:**

*If the lens cannot be removed even by using the LENS RELEASE button, the anti-theft screw for lens may be in use to secure the lens. If that is the case, remove the anti-theft screw first.*

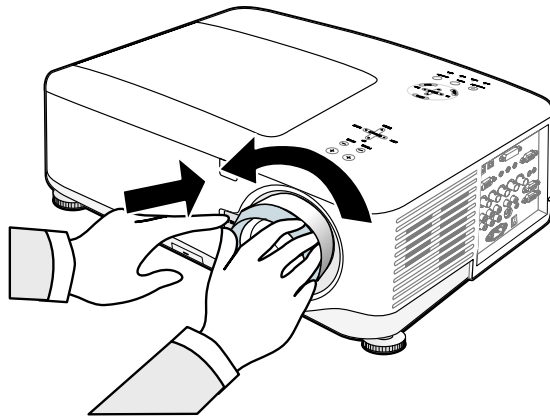

3. Pull out the existing lens slowly.

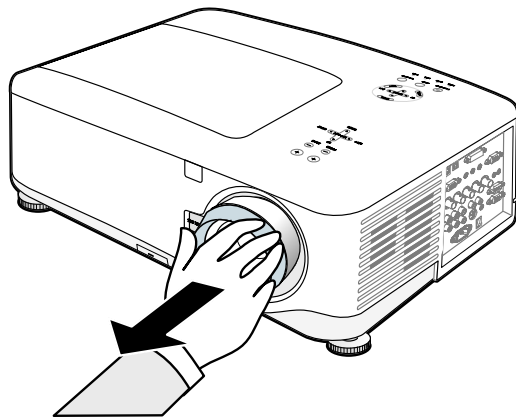

**Note:**

*When Installing the Lens into the Projector:  
Be sure to remove the lens cap from the back of the optional lens before installing the optional lens into the projector. Failure to do so will cause damage to the projector.*

## 2. Installation and Connections



### CAUTION:

When Installing the lens into the projector, be sure to remove the lens cap from the back of the optional lens before installing the optional lens into the projector. Failure to do so will cause damage to the projector.

### *Installing the New Lens*

1. Insert the lens with the arrow mark on top.

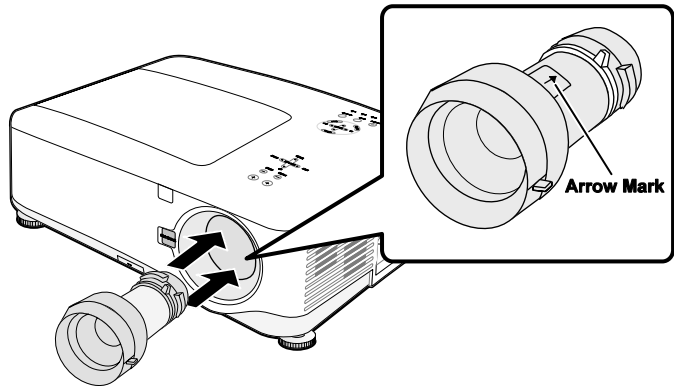

2. Rotate the lens clockwise until you feel it click into place.

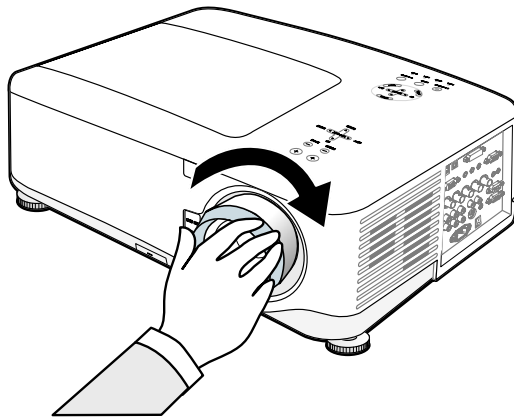

## 2. Installation and Connections

---

### *Installing the New Lens Using the anti-theft screw*

Using the anti-theft screw to prevent theft of the lens.  
Tighten the supplied anti-theft screw on the front bottom.

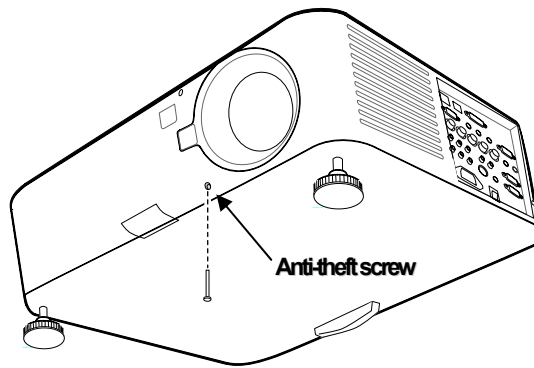

## 2. Installation and Connections

### ④ Throw Distance and Screen Size

Example of NP08ZL:

The further your projector is from the screen or wall, the larger the image. The minimum size the image can be is approximately 40 inches (1 m) measured diagonally when the projector is roughly 65 inches (1.7 m) from the wall or screen. The largest the image can be is 500 inches (12.7 m) when the projector is about 843 inches (21.4 m) from the wall or screen.

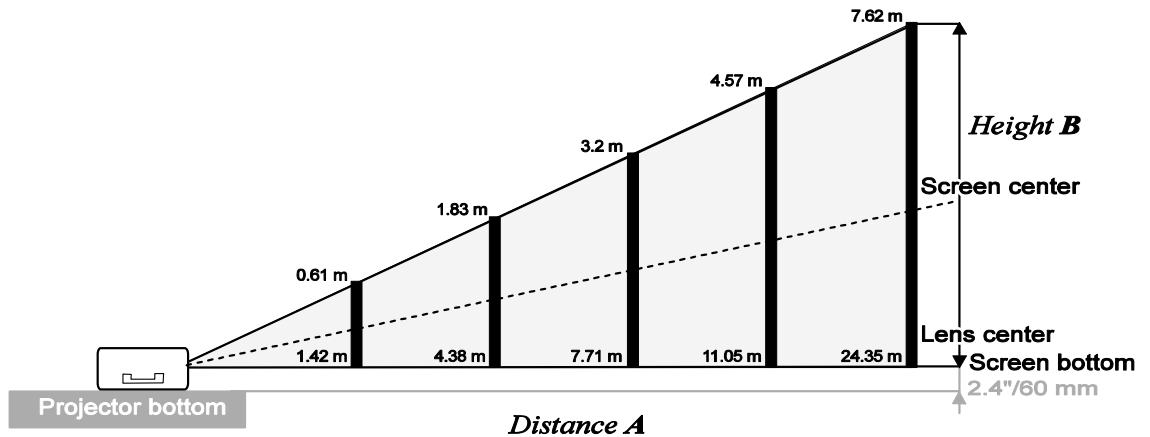

(Reference: NP08ZL)

Screen Size						NP06FL		NP07ZL		NP08ZL	
						0.77		1.33 - 1.79		1.78 - 2.35	
						Distance (A)					
Diagonal	Width		Height (B)								
[inches]	[m]	[inches]	[m]	[inches]	[m]	[inches]	[m]	[inches]	[m]	[inches]	[m]
40	1.02	32	0.81	24	0.61			41.7 - 56.8	1.06 - 1.44	55.8 - 74.4	1.42 - 1.89
50	1.27	40	1.02	30	0.76	30.7	0.78	52.6 - 71.5	1.34 - 1.82	70.4 - 93.7	1.79 - 2.38
60	1.52	48	1.22	36	0.91	37.1	0.94	63.5 - 86.1	1.61 - 2.19	85.0 - 112.9	2.16 - 2.87
67	1.70	54	1.36	40	1.02	41.6	1.06	71.1 - 96.4	1.81 - 2.45	95.2 - 126.4	2.42 - 3.21
72	1.83	58	1.46	43	1.10	44.9	1.14	76.6 - 103.7	1.94 - 2.63	102.5 - 136.0	2.60 - 3.45
80	2.03	64	1.63	48	1.22	50.0	1.27	85.3 - 115.4	2.17 - 2.93	114.1 - 151.3	2.90 - 3.84
84	2.13	67	1.71	50	1.28	52.6	1.34	89.6 - 121.3	2.28 - 3.08	120.0 - 159.0	3.05 - 4.04
90	2.29	72	1.83	54	1.37	56.5	1.44	96.2 - 130.1	2.44 - 3.30	128.7 - 170.6	3.27 - 4.33
100	2.54	80	2.03	60	1.52	63.0	1.60	107.0 - 144.7	2.72 - 3.68	143.3 - 189.8	3.64 - 4.82
120	3.05	96	2.44	72	1.83	75.9	1.93	128.8 - 174.0	3.27 - 4.42	172.5 - 228.2	4.38 - 5.80
150	3.81	120	3.05	90	2.29	95.3	2.42	161.5 - 218.0	4.10 - 5.54	216.2 - 285.9	5.49 - 7.26
180	4.57	144	3.66	108	2.74	114.6	2.91	194.1 - 261.9	4.93 - 6.65	260.0 - 343.6	6.60 - 8.73
200	5.08	160	4.06	120	3.05	127.6	3.24	215.9 - 291.2	5.48 - 7.40	289.1 - 382.0	7.34 - 9.70
210	5.33	168	4.27	126	3.20			226.8 - 305.9	5.76 - 7.77	303.7 - 401.3	7.71 - 10.19
240	6.10	192	4.88	144	3.66			259.5 - 349.8	6.59 - 8.89	347.5 - 458.9	8.83 - 11.66
261	6.63	209	5.30	157	3.98			282.3 - 380.6	7.17 - 9.67	378.1 - 499.3	9.60 - 12.68
270	6.86	216	5.49	162	4.11			292.1 - 393.8	7.42 - 10.00	391.2 - 516.6	9.94 - 13.12
300	7.62	240	6.10	180	4.57			324.8 - 437.7	8.25 - 11.12	435.0 - 574.3	11.05 - 14.59
350	8.89	280	7.11	210	5.33			379.2 - 511.0	9.63 - 12.98	507.9 - 670.4	12.90 - 17.03
400	10.16	320	8.13	240	6.10			433.7 - 584.3	11.02 - 14.84	580.8 - 766.5	14.75 - 19.47
450	11.43	360	9.14	270	6.86			488.1 - 657.5	12.40 - 16.70	653.7 - 862.6	16.60 - 21.91
500	12.70	400	10.16	300	7.62			542.6 - 730.8	13.78 - 18.56	726.6 - 958.7	18.46 - 24.35

## 2. Installation and Connections

Screen Size						NP09ZL		NP10ZL	
Diagonal		Width		Height (B)		2.22 - 4.43		4.43 - 8.3	
Distance (A)									
[inches]	[m]	[inches]	[m]	[inches]	[m]	[inches]	[m]	[inches]	[m]
40	1.02	32	0.81	24	0.61	69.4 - 142.3	1.76 - 3.61	139.2 - 266.9	3.54 - 6.78
50	1.27	40	1.02	30	0.76	87.8 - 178.9	2.23 - 4.54	175.3 - 335.0	4.45 - 8.51
60	1.52	48	1.22	36	0.91	106.2 - 215.5	2.70 - 5.47	211.5 - 403.1	5.37 - 10.24
67	1.70	54	1.36	40	1.02	119.0 - 241.2	3.02 - 6.13	236.8 - 450.8	6.01 - 11.45
72	1.83	58	1.46	43	1.10	128.2 - 259.5	3.26 - 6.59	254.8 - 484.9	6.47 - 12.32
80	2.03	64	1.63	48	1.22	142.9 - 288.8	3.63 - 7.34	283.7 - 539.4	7.21 - 13.70
84	2.13	67	1.71	50	1.28	150.3 - 303.5	3.82 - 7.71	298.2 - 566.6	7.57 - 14.39
90	2.29	72	1.83	54	1.37	161.3 - 325.4	4.10 - 8.27	319.9 - 607.5	8.12 - 15.43
100	2.54	80	2.03	60	1.52	179.7 - 362.1	4.56 - 9.20	356.0 - 675.6	9.04 - 17.16
120	3.05	96	2.44	72	1.83	216.4 - 435.3	5.50 - 11.06	428.3 - 811.8	10.88 - 20.62
150	3.81	120	3.05	90	2.29	271.6 - 545.2	6.90 - 13.85	536.6 - 1016.1	13.63 - 25.81
180	4.57	144	3.66	108	2.74	326.7 - 655.1	8.30 - 16.64	645.0 - 1220.5	16.38 - 31.00
200	5.08	160	4.06	120	3.05	363.5 - 728.3	9.23 - 18.50	717.3 - 1356.7	18.22 - 34.46
210	5.33	168	4.27	126	3.20	381.9 - 765.0	9.70 - 19.43	753.4 - 1424.8	19.14 - 36.19
240	6.10	192	4.88	144	3.66	437.0 - 874.9	11.10 - 22.22	861.8 - 1629.1	21.89 - 41.38
261	6.63	209	5.30	157	3.98	475.6 - 951.8	12.08 - 24.18	937.7 - 1772.2	23.82 - 45.01
270	6.86	216	5.49	162	4.11	492.2 - 984.7	12.50 - 25.01	970.2 - 1833.5	24.64 - 46.57
300	7.62	240	6.10	180	4.57	547.3 - 1094.6	13.90 - 27.80	1078.6 - 2037.8	27.40 - 51.76
350	8.89	280	7.11	210	5.33	639.2 - 1277.8	16.24 - 32.46	1259.2 - 2378.3	31.98 - 60.41
400	10.16	320	8.13	240	6.10	731.1 - 1460.9	18.57 - 37.11	1439.9 - 2718.9	36.57 - 69.06
450	11.43	360	9.14	270	6.86	823.0 - 1644.0	20.90 - 41.76	1620.5 - 3059.4	41.16 - 77.71
500	12.70	400	10.16	300	7.62	914.9 - 1827.2	23.24 - 46.41	1801.2 - 3400.0	45.75 - 86.36

### CAUTION



Ceiling installation must be done by a qualified professional. Contact your NEC dealer for more information.

It is not recommended you install the projector yourself.

Only use the projector on a solid, level surface. Serious injury and damage can occur if the projector falls to the ground.

Do not use the projector in an environment where extreme temperature occurs. The projector must be used at temperatures between 41 degrees Fahrenheit (5 degrees Celsius) and 104 degrees Fahrenheit (40 degrees Celsius).

Screen damage will occur if the projector is exposed to moisture, dust or smoke.

Do not cover the vents on the projector. Proper ventilation is required to dissipate heat. Damage to the projector will occur if the vents are covered.

### ⑤ Replacing Color Wheel

The NP4000 projector comes with a four-segment color wheel installed. An additional six-segment color wheel comes included. To replace the color wheel (located under the lamp cover adjacent to lamp 1) refer to the following guide.

**Note:**

*Wait until the lamp house and the color wheel cool off.*

1. Loosen the captive screw (A) on the lamp cover.
2. Remove the lamp cover by sliding in the direction of the arrow (B).

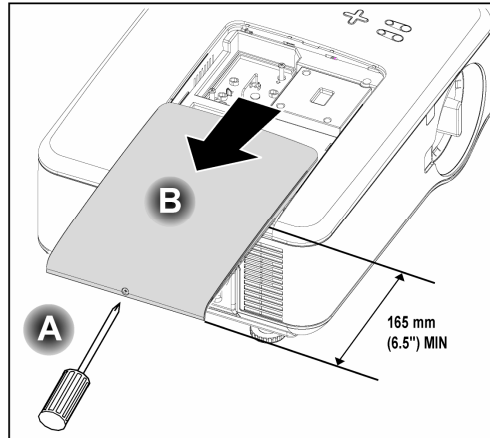

3. Remove the screws from the color wheel cover. Lift cover in the direction shown and place on a clean, dust free surface.

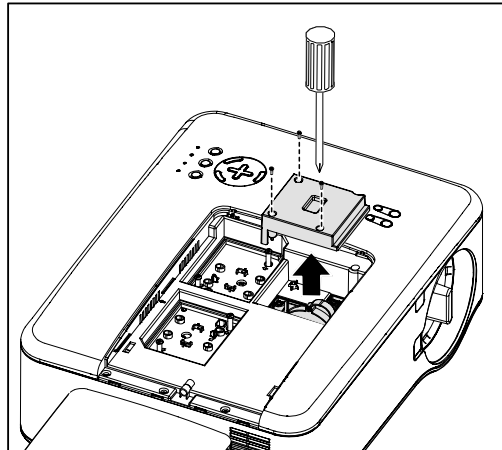

## 2. Installation and Connections

---

- 4.** Unscrew the retaining screws on the four-segment color wheel.

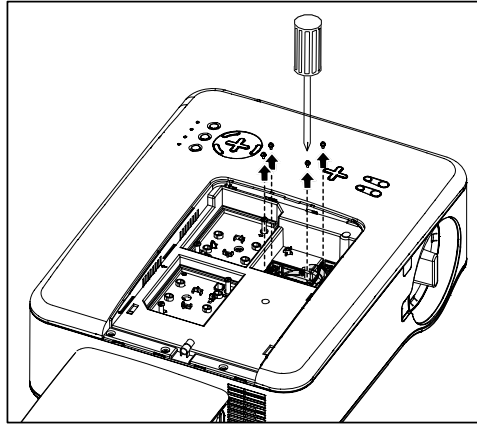

- 5.** Lift the unit in the direction shown.

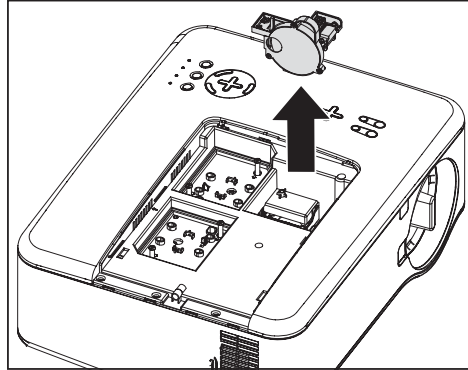

- 6.** Insert the six-segment color wheel

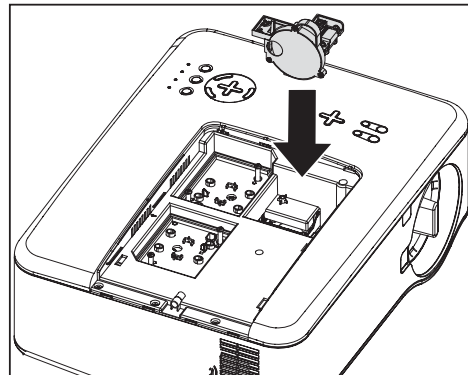

## 2. Installation and Connections

- 7.** Secure the retaining screws as shown.

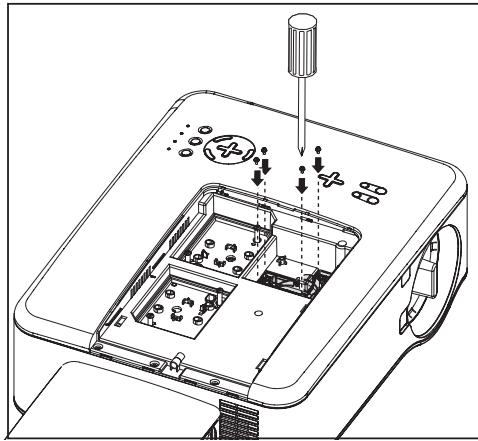

- 8.** Replace the wheel cover as shown and secure the screws to lock the cover in place.

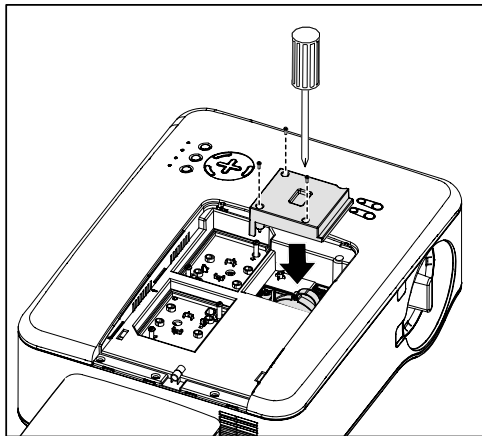

- 9.** Align the lamp cover (A) with the arrow mark on the cabinet and slide it into place.

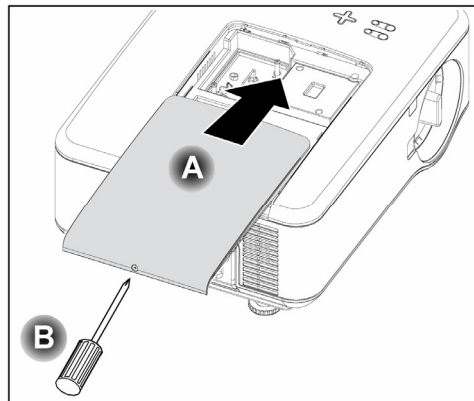

### Storing Unused Color Wheel:

Keep the unused color wheel in the zipper bag in which the supplied 6-segment color wheel was packaged.

This bag prevents dust from falling or collecting on the color wheel.

## 2. Installation and Connections

---

### ⑥ Making Connections

#### Connecting Your PC or Macintosh Computer

##### *Enabling the computer's external display*

Displaying an image on the notebook PC's screen does not necessarily mean it outputs a signal to the projector. When using a PC compatible laptop, a combination of function keys will enable/disable the external display. Usually, the combination of the **Fn-key** along with one of the 12 function keys gets the external display to come on or off. For example, NEC laptops use **Fn + F3**, while Dell laptops use **Fn + F8** key combinations to toggle through external display selections.

To connect a PC or Macintosh computer to the projector, refer to the following guide.

1. Connect a computer to the projector through one of the three available input data connections before turning on the PC or the projector. The best signal order (from best to least suitable) is as follows:
  - Computer 3 in as shown below (see item 1, ⑤ Terminal Panel Features on page 10) is a digital signal and offers the best connection to your computer.

**Note:**

*The DVI(DIGITAL) connector (COMPUTER 3) accepts VGA(640 x 480), 1152 x 864, XGA(1024 x 768), SXGA(1280 x 1024@up to 60Hz) and SXGA+(1400 x 1050 @ up to 60Hz).*

- Computer 2 in (see item 17, ⑤ Terminal Panel Features on page 10) is an analog signal; use a DSUB-15 cable-to-5BNC connection.
- Computer 1 in (see item 18, ⑤ Terminal Panel Features on page 10) an analog signal that uses a standard RGB computer cable.

## 2. Installation and Connections

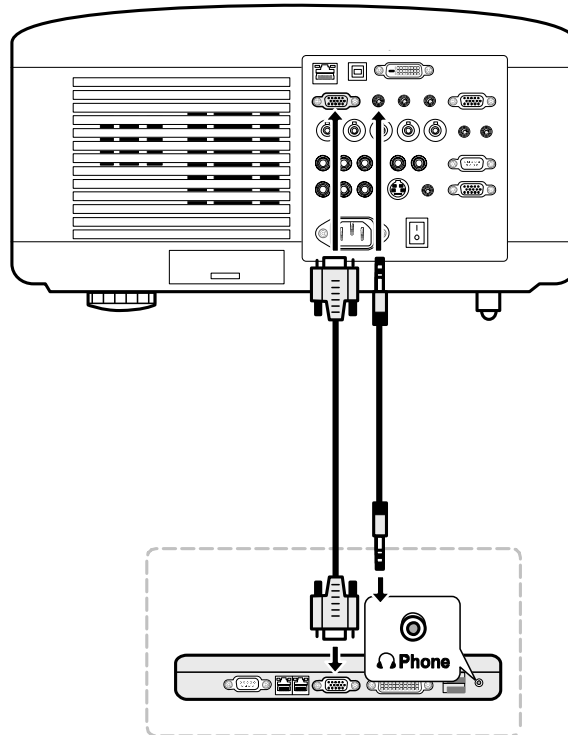

2. Turn on the projector and select the chosen method of connection from the source menu before turning on the PC (see [Selecting a Source](#) on page 36).
3. Turn on the PC.

**Note:**

*Failure to follow the above steps may not activate the digital output of the graphics card resulting in no picture being displayed. Should this happen, restart your PC.*

## 2. Installation and Connections

---

### Connecting an External Monitor

Connect an external monitor to the projector through RGB out connections as shown below (see item 4, **Terminal Panel Features** on page 10)

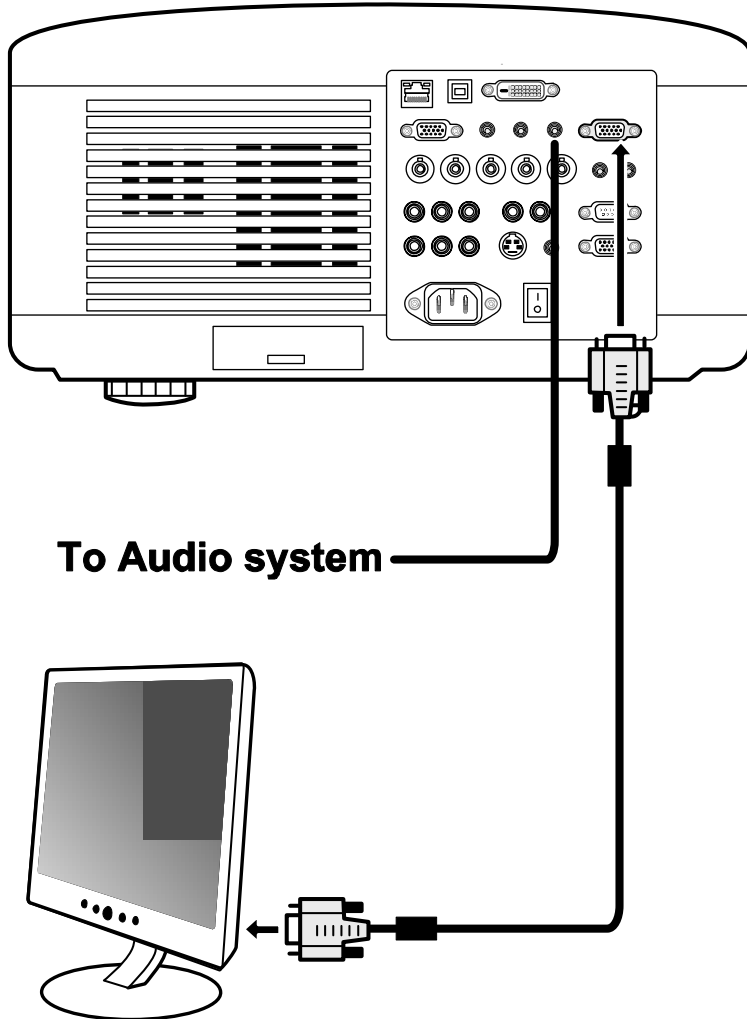

### Connecting Your DVD Player with Component Output

To connect a DVD Player to the projector, refer to the following guide.

1. Connect the DVD Player to the projector as shown below before turning on the Player or the projector.

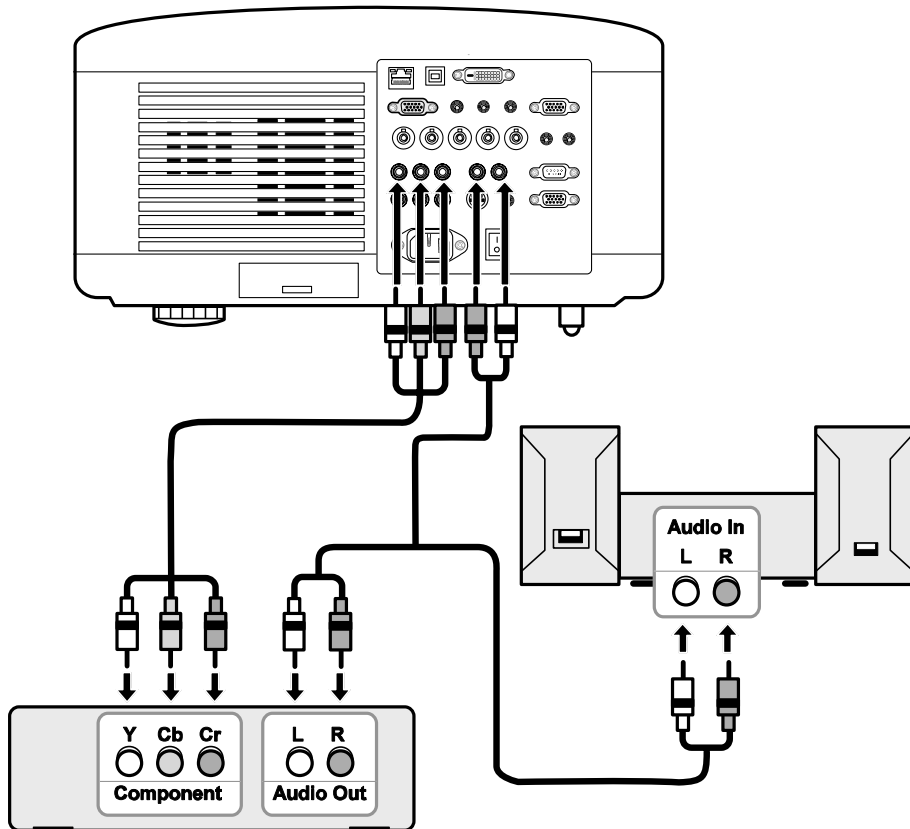

2. Turn on the projector and select **Component** from the source menu before turning on the DVD Player (see  Selecting a Source on page 36).
3. Turn on the DVD Player.

**Note:**

Refer to your DVD player's owner's manual for more information about your DVD player's video output requirements.

## 2. Installation and Connections

### Connecting Your VCR or Laser Disc Player

To connect your VCR or Laser Disc Player, refer to the following diagram.

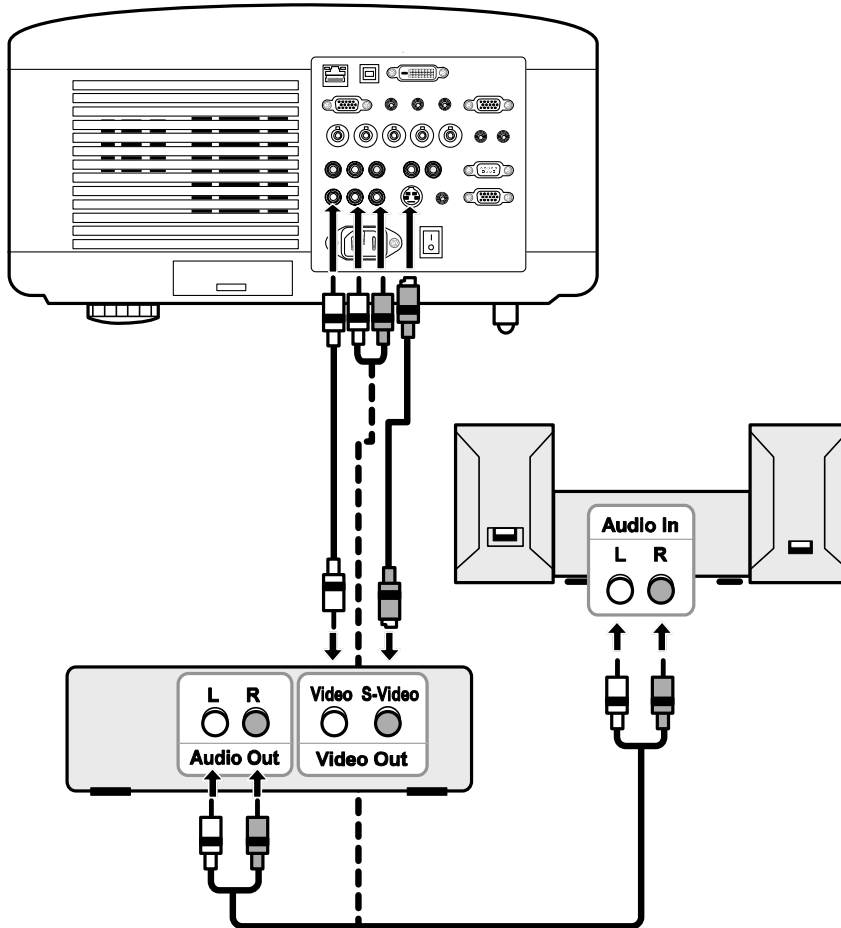

**Note:**

Refer to your VCR or laser disc player owner's manual for more information about your device's requirements.

Images may not be displayed correctly when using an S-Video or Video connection to fast-forward or fast-rewind scanning.

The AUDIO IN RCA jack is shared between VIDEO IN and S-VIDEO IN.

### 7 Connecting the Supplied Power Cable

Refer to the following guidelines to connect the power supply to the projector.

1. Locate the projector correctly. See 2 Selecting a Location on page 18.
2. Ensure Main Power switch is in the off position (O).
3. Connect power cable to mains outlet.
4. Connect power cable to power inlet (AC IN) on the projector, see 5 Terminal Panel Features on page 10.

**Note:**

*Make sure that the prongs are fully inserted into both the AC IN and the wall outlet.*

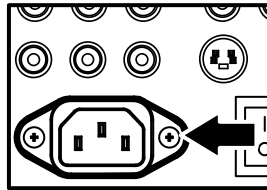

**Note:**

*Ensure that the cables do not create a trip hazard.*

# 3. Projecting an Image (Basic Operation)

## 1 Turning on the Projector

Once the projector is correctly located and the power cable and other connections are in place, it is important that the projector is powered on correctly in order to avoid damage to components and unnecessary wear and tear. Refer to the following guide to power on the projector.

1. Connect the power cable (A). Press the main power switch (I) to the on position as shown (B). The power LED lights orange.

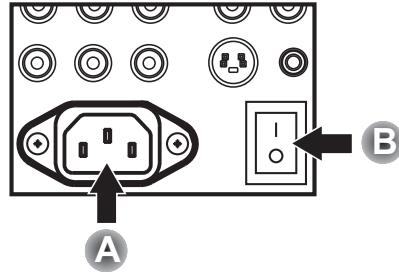

2. Press the **On/Standby** button once (see OSD Controls and Status LEDs on page 8). The power LED lights green and the internal cooling fan starts.

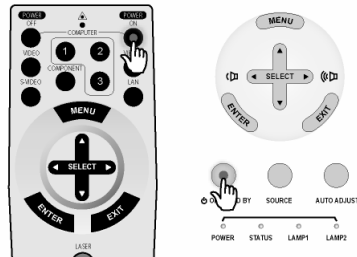

3. After approximately 10 seconds, the power LED flashes intermittently green.



4. The Lamp1 and Lamp2 LEDs light green and the Power LED flashes more rapidly.



5. Once the power LED is lit solidly green, the projector is ready for use.

### Note:

If any of the LEDs remain flashing or blink there may be a problem with the startup. Please refer to the [Troubleshooting](#) section on page 104.

### 3. Projecting an Image (Basic Operation)

#### Note on Startup Screen (Menu Language Select screen)

In the first instance of powering on the projector, the language menu is displayed to select the default language.

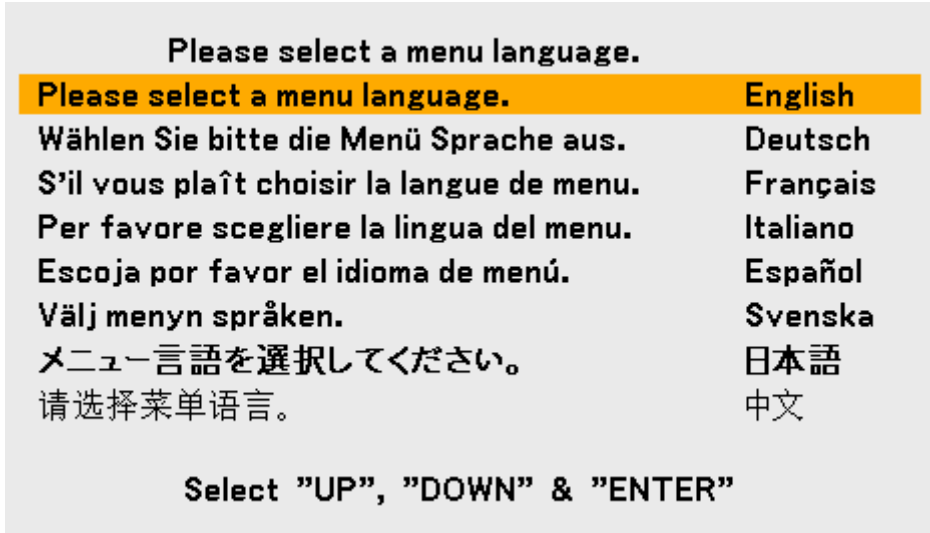

Select the required default language using the ▲ or ▼ buttons on the OSD menu panel or the remote control unit and press **Enter**.

**Note:**

*The language select screen only appears on the first instance of power on. All subsequent operations assume the selected default language. To change the default see page 76.*

### 3. Projecting an Image (Basic Operation)

---

#### ② Selecting a Source

The Source can be selected from the projector's control panel or from the remote control unit. Refer to the following guide to select Source.

1. Press **Menu** on the OSD control panel or on the remote control unit to display the **Main Menu**. Scroll to the **Source** menu using **▲** or **▼** and press **Enter**.

**Note:**  
Return to the projected image by pressing **Exit** twice.

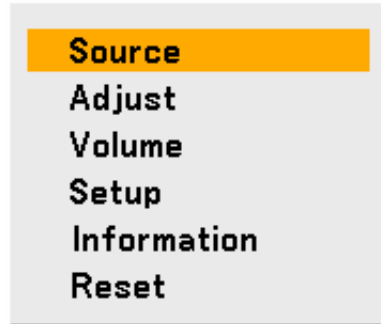

2. Select the required source using **▲** or **▼** and press **Enter**.

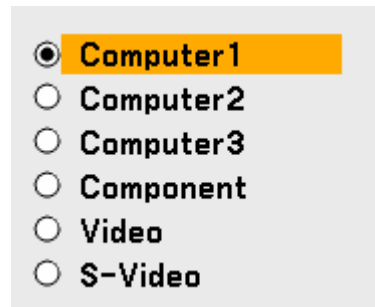

### 3. Projecting an Image (Basic Operation)

#### ③ Adjusting the Picture Position and Picture Size

The Picture Position and Picture Size can be adjusted manually from the lens control panel or from the remote control unit. Refer to the following guides to adjust Picture Position manually.

##### *Adjusting Picture Position Manually*

1. Press the Select keypad in any direction to bring up the Lens Shift window.

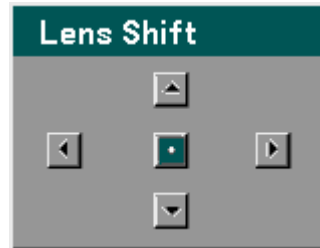

2. Press the directional key as required to shift the image. Releasing the directional arrow will re-center the cursor.

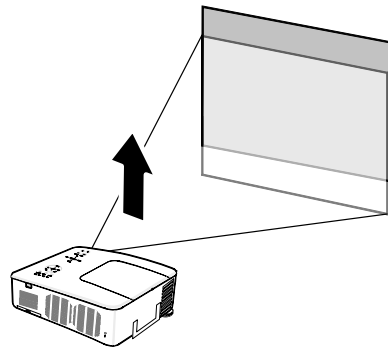

3. To alter the picture size, press **Menu** and select the **Adjust** menu using **▲** or **▼**. Press **Enter** to open the **Adjust** menu. Press **◀** or **▶** to select **Image Options** followed by **▲** or **▼** to select the **Aspect Ratio**. Press **Enter**.

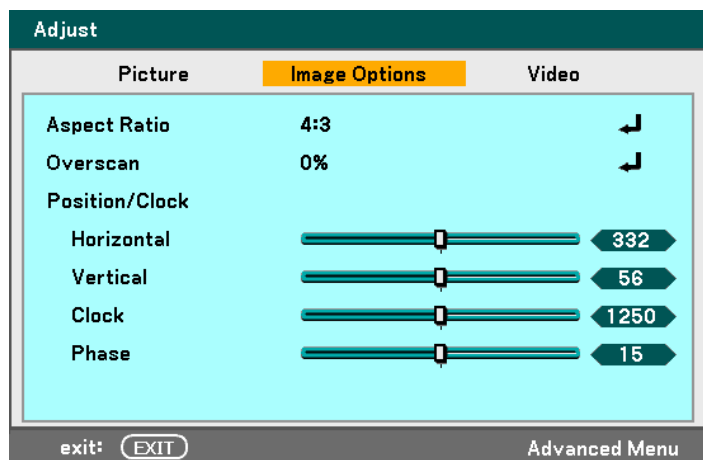

### 3. Projecting an Image (Basic Operation)

- The **Aspect Ratio** window is displayed. Select the desired picture size using **▲** or **▼** and press **Enter**.
- When finished, press **Exit** to return to the projected image.

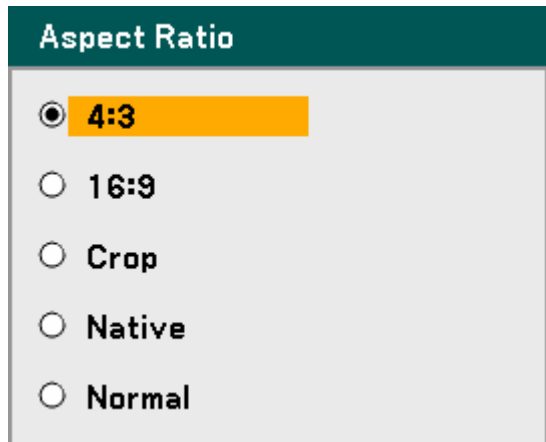

### Lens Shift Adjustable Range

The adjustable range for lens shift is tabulated below and subject to the conditions listed.

**Note:**

The drawings below are applied to the lenses for NP07ZL, NP08ZL, NP09ZL, and NP10ZL. The lens for NP06FL does not have a lens shift feature.

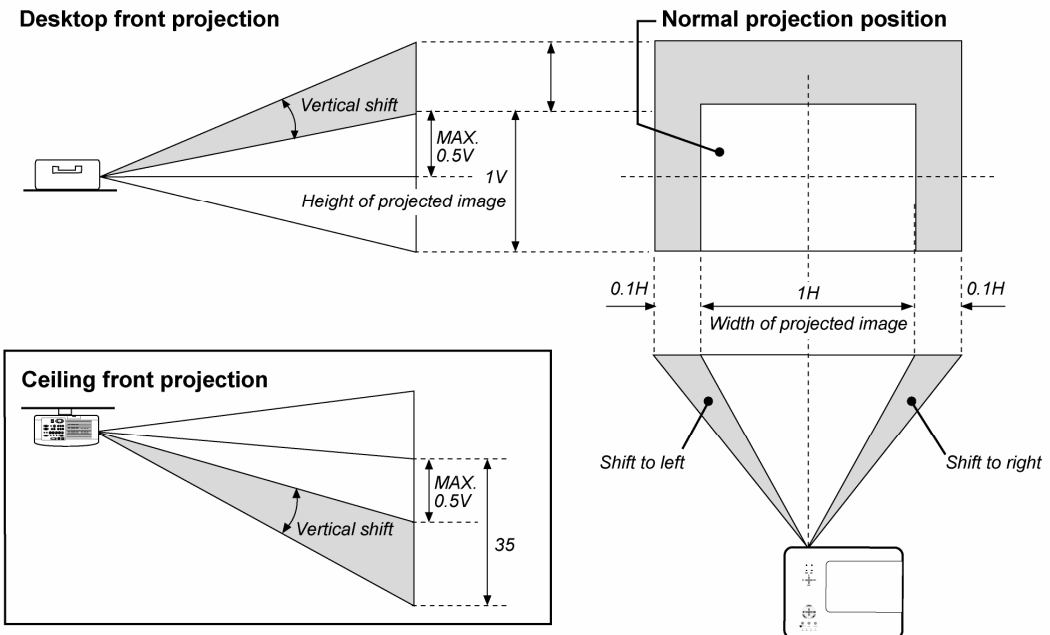

### 3. Projecting an Image (Basic Operation)

#### *From the Remote Control Unit*

1. Press the **Lens Shift** button to bring up the Lens Shift window.

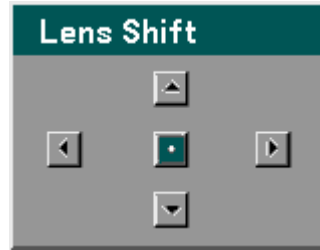

2. Press the directional keys as required to shift the image. Releasing the directional arrow will re-center the cursor.

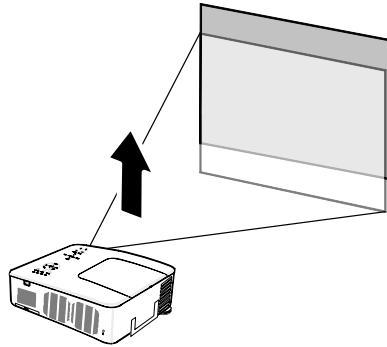

3. To alter the picture size, press the **Aspect** button to display the Aspect Ratio window.

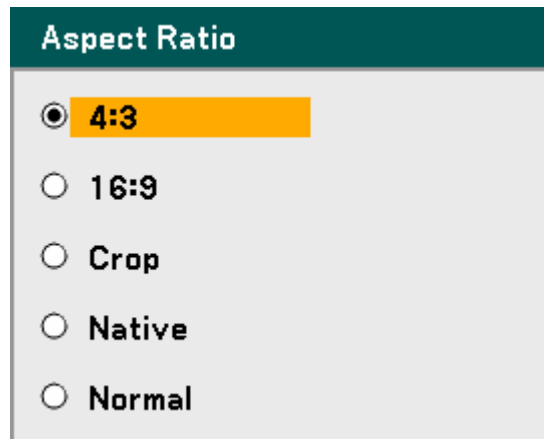

4. Select the desired picture size using **▲** or **▼** and press **Enter**.
5. When finished, press **Exit** to return to the projected image.

### 3. Projecting an Image (Basic Operation)

---

#### *Adjusting the Projector Level*

1. To raise the level of the projector, twist the adjusters clockwise.

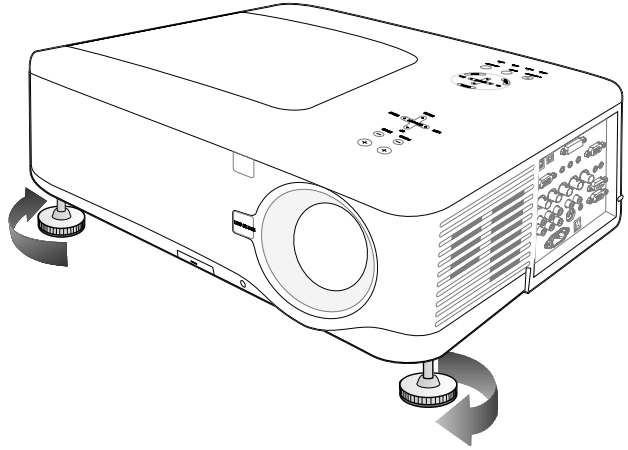

2. To lower the level of the projector, lift the projector and twist the adjusters counter clockwise.

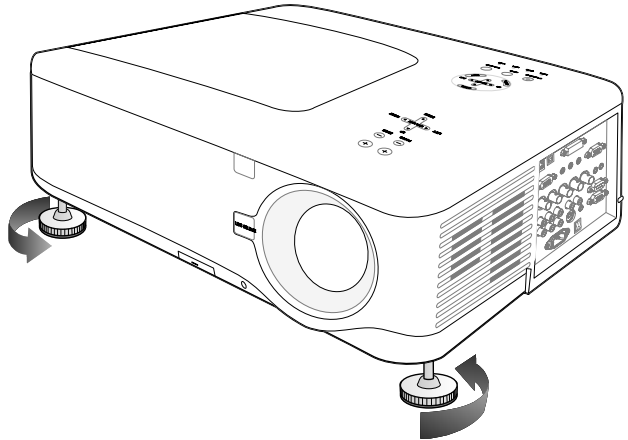

#### ④ Optimizing an RGB Image Automatically

##### *Adjusting the Image Using Auto Adjust*

To optimize an RGB image automatically refer to the following guide.

Press the Auto ADJ. button on the Remote Unit (see item 27, ⑥ Part Names of the Remote Control on page 12) to optimize an RGB image automatically.

This adjustment may be necessary when you connect your computer for the first time.

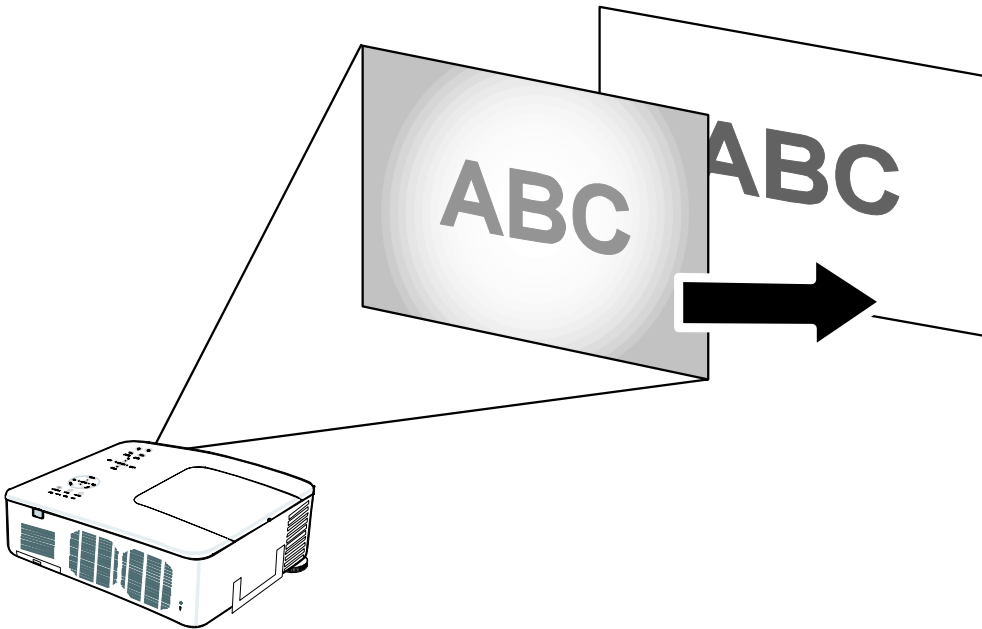

### 3. Projecting an Image (Basic Operation)

#### ⑤ Adjusting Volume Up and Down

The volume can be adjusted from the OSD Control Panel or with the Remote Control unit. Refer to the following as a guide.

1. Press the **Volume +/-** buttons on the remote control or the **Select** pad left and right keys on the OSD control panel. The volume level is displayed on screen.

2. Use the **Volume +/-** buttons or the **Select** pad left and right keys on the OSD control panel to adjust the level.

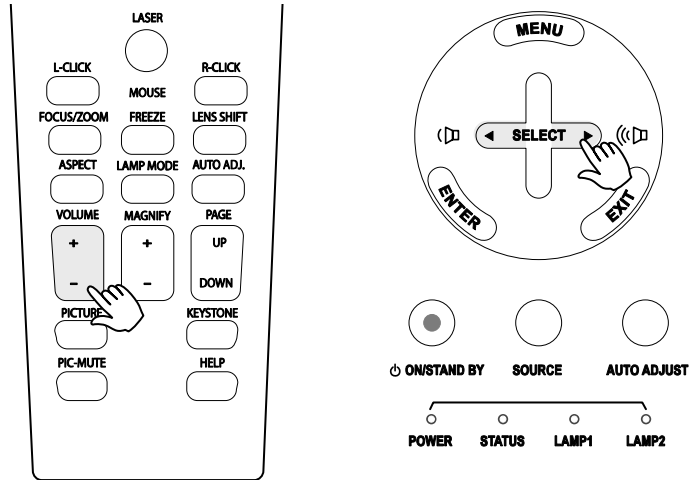

### 3. Projecting an Image (Basic Operation)

## 6 Turning off the Projector

Once the projector is no longer required, it is important to shut it down correctly to avoid damage or unnecessary wear and tear to the projector.

### CAUTION



- Do not unplug the power cable from the wall outlet or projector when the projector is powered on. Doing so can cause damage to the AC IN connector of the projector and (or) the prong plug of the power cable. To turn off the AC power supply when the projector is powered on, use a power strip equipped with a switch and a breaker.
- Do not turn off the AC power supply within 10 seconds of making adjustment or setting changes and closing the menu. Doing so can cause loss of adjustments and settings and return to default.

Refer to the following guide to shut down the projector.

1. Press the **On/Standby** button once. The OSD displays the message shown on the right.



2. Press the **On/Standby** button again or **Enter** on the OSD control panel or the remote control to verify power off. The cooling fans keep operating for a while (Cooling-off time). The cooling fans stop operating when the projector turns off.

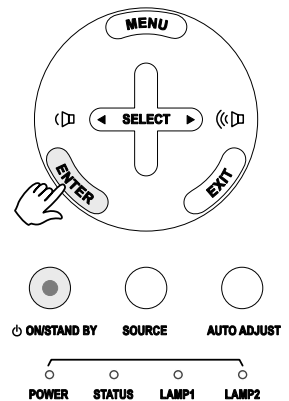
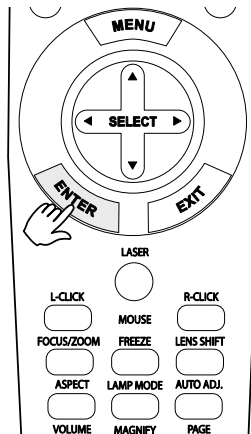

3. The projector enters Standby mode and the power LED lights orange.

4. Press the Main Power switch to the off position (O) to turn off the projector.

Please wait a moment.

### 3. Projecting an Image (Basic Operation)

---

#### *About Direct Power Off*

The projector has a feature called "Direct Power Off". This feature allows the projector to be turned off (even when projecting an image) using a power strip equipped with a switch and a breaker.

**Note:**

*Before using Direct Power Off, be sure to allow at least 20 minutes immediately after turning on the projector and starting to display an image.*

#### *After Use*

Preparation: Make sure that the projector is turned off.

1. Unplug the power cable.
2. Disconnect any other cables.
3. Return the height adjusters to their original, minimum position.
4. Cover the lens with the lens cap.

## 4. Convenient Features

---

### ① Turning Off the Image and Sound

The projected image and sound can be turned off for short periods of time with the remote control. This feature is useful for breaking up presentations or for other brief interruptions in projections. To turn off the picture and image, refer to the following guide.

1. Press the **PIC-MUTE** button on the remote control once (see ⑥ Part Names of the Remote Control on page 12).
2. To resume projection, press the **PIC-MUTE** button once more.

**Note:**

*For extended periods of time it is recommended that the projector be powered off.*

### ② Freezing a Picture

The projected image can be frozen for short periods of time via the remote control. This feature is useful for capturing still images from movies or freezing an animation at a particular point. To freeze the projected image, refer to the following guide.

1. Press the **Freeze** button on the remote control once (see ⑥ Part Names of the Remote Control on page 12).
2. The screen freezes.
3. To resume, press the **Freeze** button once more.

**Note:**

*For extended periods of time it is recommended that the projector be powered off.*

## 4. Convenient Features

### ③ Adjusting the Focus/Zoom Manually

The focus and zoom can be adjusted manually from the projector focus/zoom panel or from the remote control unit. Refer to the following guides to adjust the focus and zoom manually.

#### *Adjusting by Using the OSD Control Panel*

1. Press the **Focus** or **Zoom** button on the projector panel to display the appropriate window.



2. Adjust the focus/zoom using the increase and decrease buttons as required.

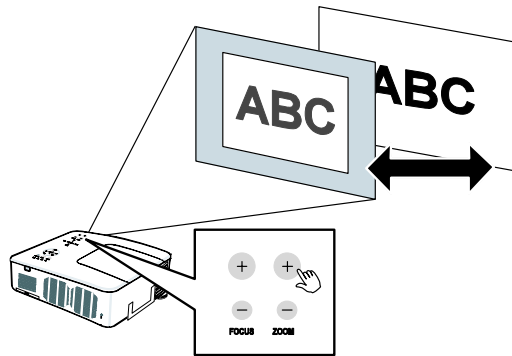

3. Press **Exit** to return to the projected image.

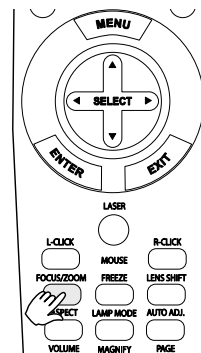

### ④ Changing Lamp Mode

The projector has two lamp modes available, **Normal** and **Eco**. The **Normal** mode is used for everyday standard projection, whereas the **Eco** mode is used for saving power and lamp life. To change the Lamp Mode, refer to the following guides.

#### Changing Lamp Mode by Using the Projector's OSD Control Panel

1. Press **Menu** on the projector's OSD control panel to display the **Main Menu**. Scroll to the **Setup** menu using **▲** or **▼** and press **Enter**.

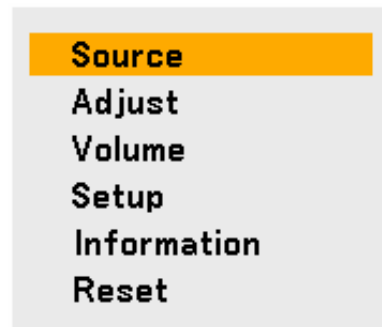

2. Select the **General** tab using **◀** or **▶** and select **Lamp Mode** using **▲** or **▼**. Press **Enter**.

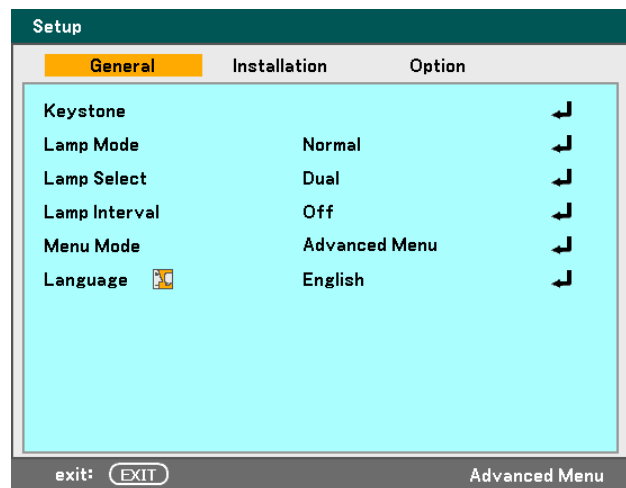

3. From the **Lamp Mode** window, select **Normal** or **Eco** using **▲** or **▼**. Select **OK** and press **Enter**.

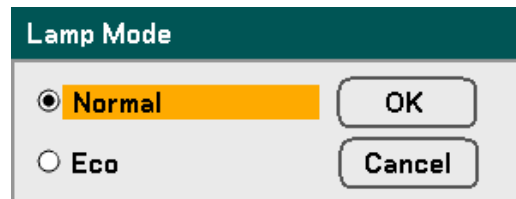

## 4. Convenient Features

---

### Changing Lamp Mode by Using the Remote Control

1. Press the **Lamp Mode** button on the remote control to access the Lamp Mode menu.

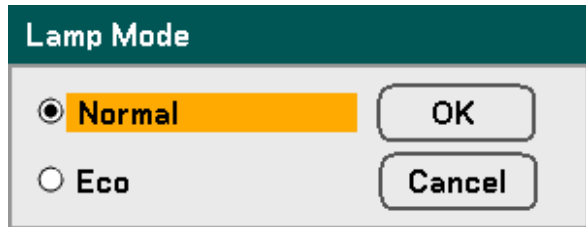

2. From the **Lamp Mode** window, select **Normal** or **Eco** using **▲** or **▼**. Move the cursor to **OK** and press **Enter**.

**Note:**

*When the projector is in Eco mode, brightness may be affected.*

*Normal Mode: 100% Brightness*

*Eco Mode: approx. 85% Brightness*

### 5 Getting Information

Press the **HELP** button on the remote control to display the "Information" screen. Use ◀ or ▶ to select a tab.

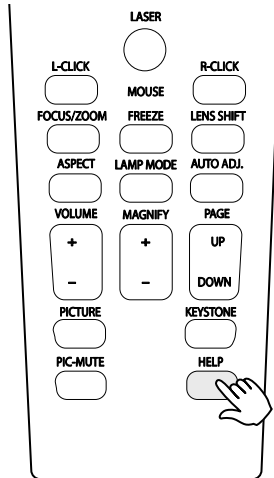

Information			
Usage Time	Source	LAN	Version
Lamp1 Life Remaining			50%
Lamp2 Life Remaining			50%
Lamp1 Hours Used	1000[H]		
Lamp2 Hours Used	1000[H]		
Filter Hours Used	1000[H]		

exit: **EXIT** Advanced Menu

## 4. Convenient Features

### ⑥ Adjusting Position/Clock

The Position/Clock/Phase and Keystone Correction can be adjusted manually from the projector's control panel or from the remote control unit. Refer to the following guides to adjust the Keystone Distortion manually.

#### *Adjusting Position/Clock/Phase by Using the OSD Control Panel*

1. Press the Menu button to display the Main menu. Select the Adjust menu using ▲ or ▼ and press **Enter** to display the Adjust menu.

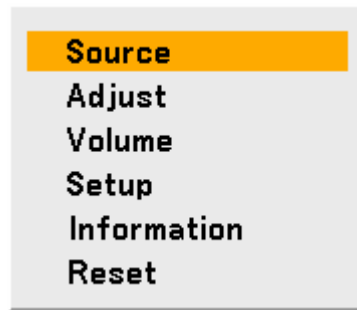

2. From the Adjust menu, press ◀ or ▶ to select Image Options and scroll using ▲ or ▼ to **Horizontal, Vertical, Clock, or Phase**.

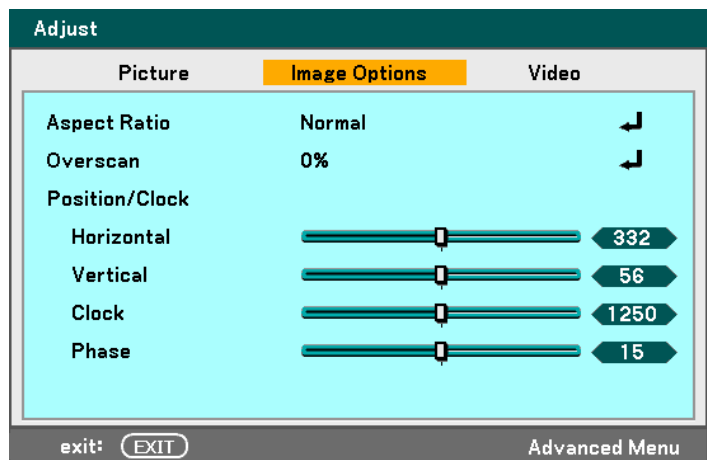

3. Adjust the **Horizontal, Vertical, Clock, or Phase** sliding bars using the select ▲ ▼ ◀ ▶ buttons.
4. Press **Exit** to return to the projected image.

### Correcting Keystone by Using the Remote Control



**IMPORTANT:**

When adjusting the keystone, place the projector in the following position.

- Horizontal: set to the lens center
- Vertical: set to the maximum top

1. Press the **Keystone** button to display the Keystone window.
2. Adjust the **Horizontal** and **Vertical** sliding bars using the select **▲▼◀▶** buttons.
3. Adjust the slide bars until the screen trapezoid is a regular shape (see diagram).
4. Press **Exit** to return to the projected image.

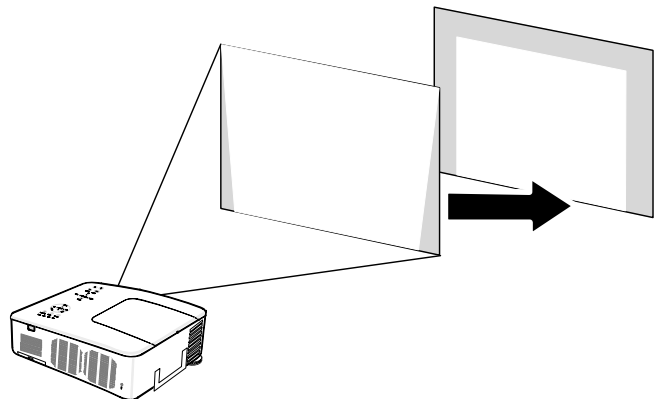
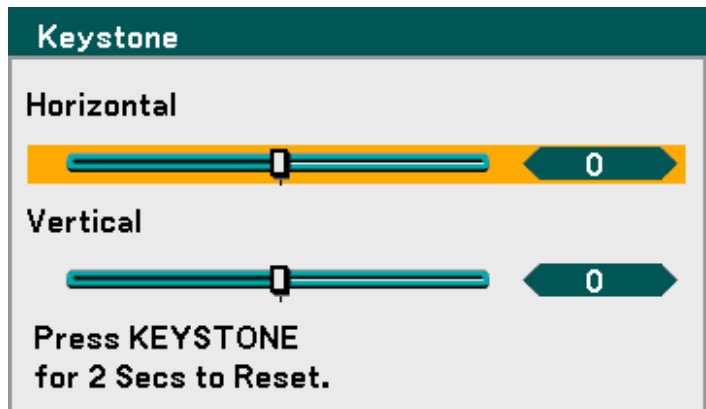

**Note:**

Holding down the **Keystone** button 2 seconds resets the default keystone values.

## 4. Convenient Features

---

ADJUSTMENT	HORIZONTAL	VERTICAL
Keystone	Max. +/- 35° approx.	Max. +/- 40° approx.

The following are conditions under which the maximum angle is achieved:

- When the NP08ZL lens is used
- When the lens shift is set to H for center and V for 0.5 shift.
- When the lens shift is used and yet you do not get the above-mentioned condition (H for center and V for 0.5 shift), you cannot adjust the lens shift correctly.
- Image is projected in Wide mode
- Resolution is XGA

**Note:**

*Higher resolution than XGA narrows the adjustable range.*

Menu items should be set as follows:

- Aspect Ratio ..... 4:3

Horizontal and Vertical are adjusted separately.

A combination of both adjustments narrows the adjustable range.

## 7 Preventing the Unauthorized Use of the Projector

The projector has an inbuilt security feature to lock the OSD control panels and deny remote control operation. The security feature has no default keyword; in the first instance of enabling the security feature, the user must define a keyword.

### Locking the Projector

To setup the security keyword, refer to the following guide.

1. Press **Menu** on the OSD control panel on the projector or remote control to display the **Main Menu**. Scroll to the **Setup** menu using **▲** or **▼** and press **Enter**.

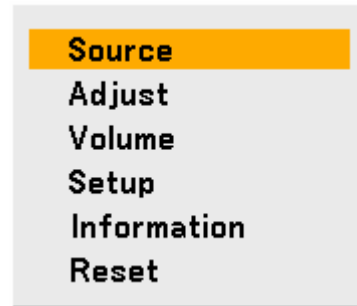

2. The **Setup** menu is displayed. Select the **Installation** tab using **◀** or **▶** and select **Security** using **▲** or **▼**. Press **Enter**.

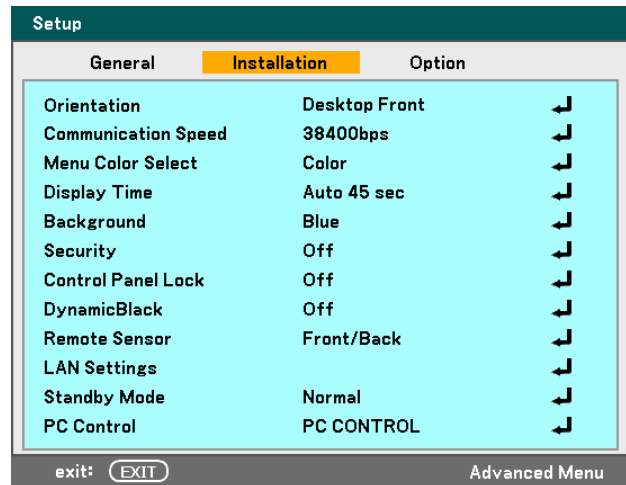

## 4. Convenient Features

3. You are prompted to enable the Security Function. Select **OK** and press **Enter**.  
Select **On** using the ▼ button.

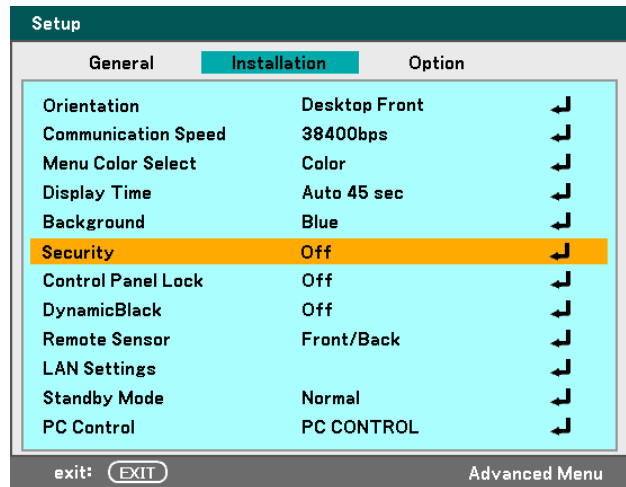

4. The keyword window is displayed. Enter a keyword between 4 and 10 characters using ▲▼◀▶. Press **Enter**.

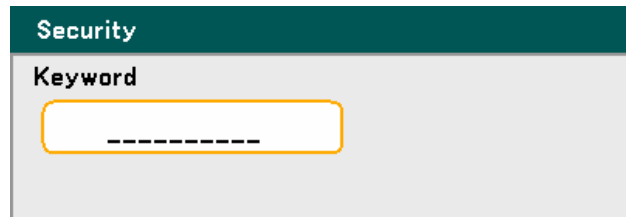

5. Once a successful keyword is entered, a confirmation screen is displayed. Enter the same password as the previous step and write it down for later reference. Press **Enter**. A security activation message is displayed. Select **Cancel** to return to the **Setup** menu or select **OK** to enable security.

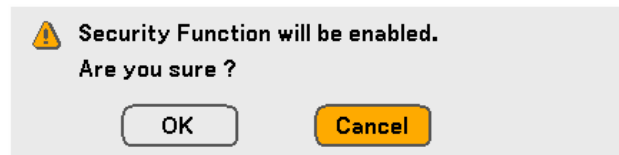

### Unlocking the Projector

To unlock the projector, refer to the following guide.

1. When the projector is locked, either by request during operation or at start up, the locked message is displayed.
2. To unlock the projector, press **Menu** on the control panel or remote control. The keyword window is displayed. Enter the previously defined keyword to activate the projector.



Projector is locked! Enter your keyword.

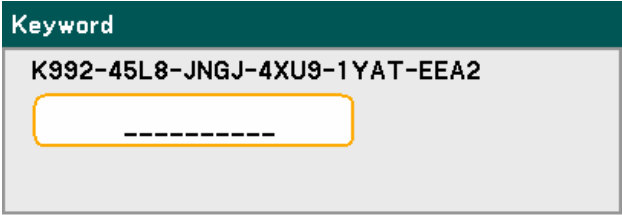

Keyword

K992-45L8-JNGJ-4XU9-1YAT-EEA2

-----

## 4. Convenient Features

### ⑧ Using the Physical Lock

For security and authorized usage, the projector comes with two types of security features, the Kensington Lock and the Security Chain Lock.

#### Using the Kensington Lock

If you are concerned about security, attach the projector to a permanent object with the Kensington slot and a security cable.

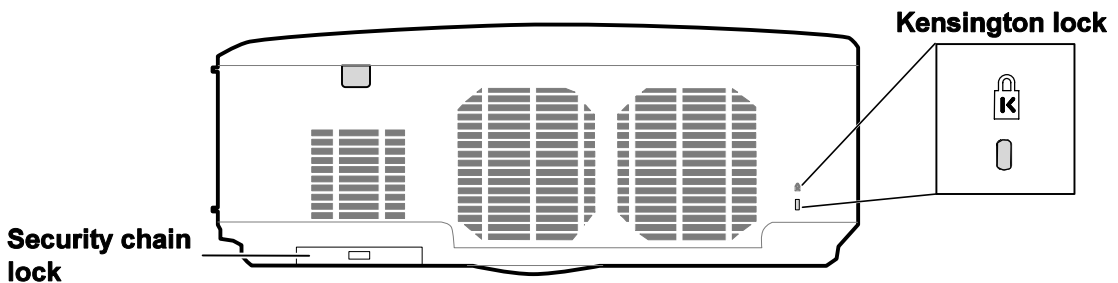

#### **Note:**

Contact your vendor for details on purchasing a suitable Kensington security cable. The security lock corresponds to Kensington's MicroSaver Security System. If you have any comment, contact: Kensington, 2853 Campus Drive, San Mateo, CA94403, U.S.A. Tel: 800-535-4242, <http://www.Kensington.com>.

#### Using the Security Chain Lock

In addition to the password protection function and the Kensington lock, the Security Chain Opening helps protect the NP4000 from unauthorized use.

See the following picture.

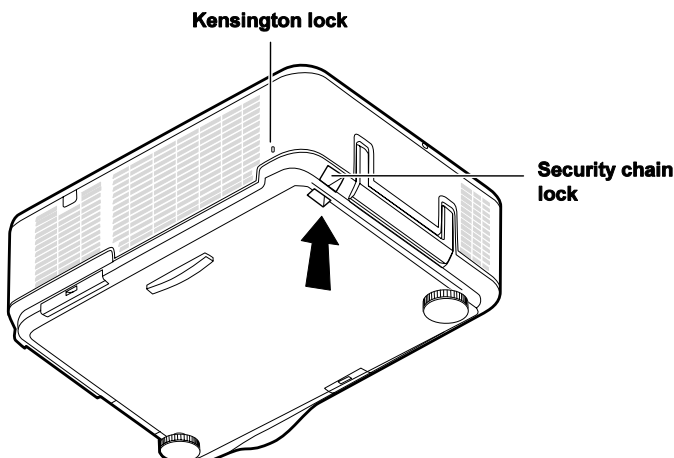

# 5. Using On-Screen Display

## 1 Using the Menu

The projector has an On-Screen Display (OSD) that lets you make image adjustments and change various settings.

### Navigating the OSD

You can use the remote control or the buttons on the top of the projector to navigate and make changes to the OSD. The following illustration shows the corresponding buttons on the remote control and on the projector.

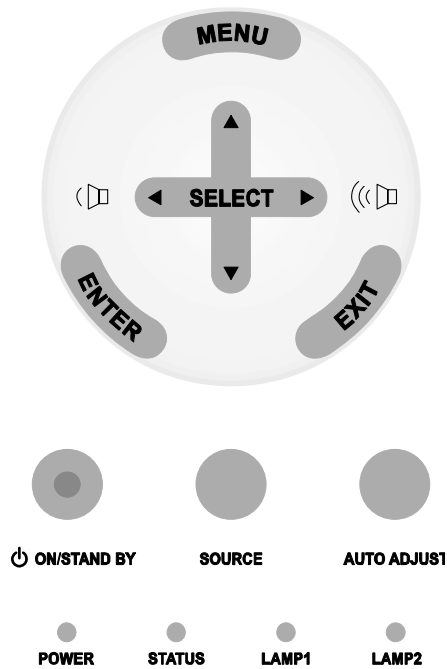

1. To open the OSD, press the **Menu** button on the OSD control panel or remote unit. There are six initial menus. Press the cursor **▲** or **▼** buttons to move through the initial menus and **Enter** to select the desired menu.

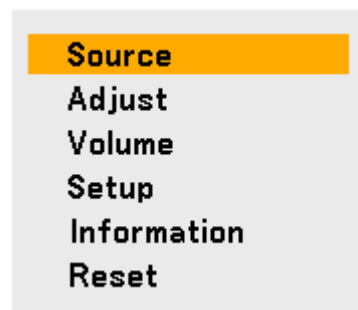

## 5. Using On-Screen Display

2. Press the cursor ◀ or ▶ button to move through secondary menus.

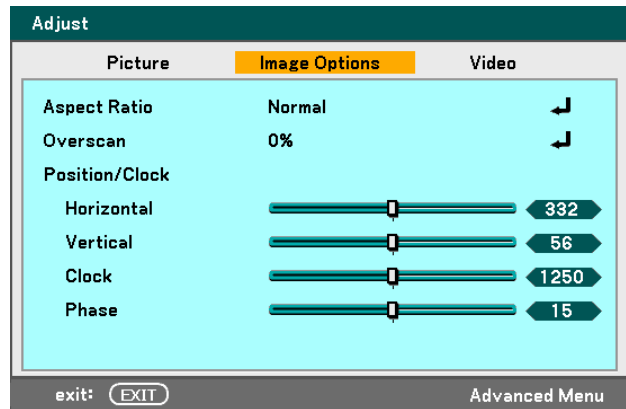

3. Press ▲ or ▼ to select menu items and ◀ or ▶ to change values for settings. Press **Enter** to confirm the new setting.

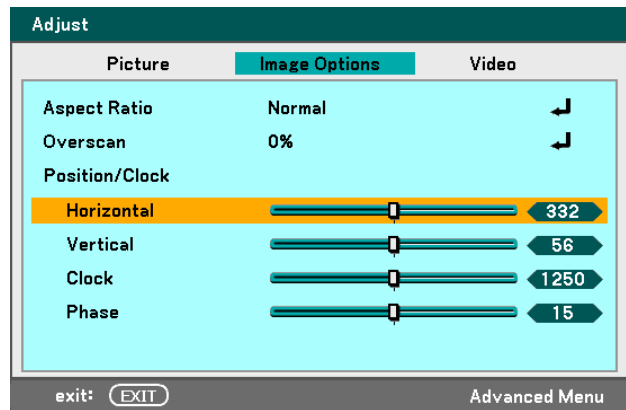

4. Press **Exit** to close the OSD or leave a submenu.

### ② Menu Tree

The gray shaded area indicates factory default settings.

MENU		ITEM		
Source		Computer 1, Computer 2, Computer 3, Component, Video, S-Video		
Adjust	Picture	Preset	High-Bright/Presentation/Video/Movie/Graphic/sRGB	
		Detail Settings	General	Reference
				High-Bright/Presentation/Video/Movie/Graphic/sRGB
				Gamma Correction
				Dynamic/Natural/Black Detail
				Color Temperature
				5000K/6500K/7800K/8500K/9300K/10500K
				BrilliantColor
			White Balance	Brightness R
				Brightness G
				Brightness B
				Contrast R
				Contrast G
				Contrast B
			Color Correction	Red, Green, Blue, Yellow, Magenta, Cyan
			Contrast	
			Brightness	
			Sharpness	
			Color	
			Hue	
			Reset	
	Image Options	Aspect Ratio	4:3/16:9/Crop/Native/Normal	
		Overscan	0%/5%/10%/15%	
		Position/Clock	Horizontal	
			Vertical	
			Clock	
			Phase	
	Video	Noise Reduction	Off/Low/Medium/High	
		3D Y/C Separation	Off/On	
		Deinterlace	Off/Still/Normal/Movie	
		Color Matrix	Auto/RGB/SDTV/HDTV	
		Telecine	Off/2-2/2-3 Auto/2-2 On/2-3 On	
Volume		0-61		
Setup	General	Keystone	Horizontal	
			Vertical	
		Lamp Mode	ECO/NORMAL	
		Lamp Select	Dual/Lamp1/Lamp2	
		Lamp Interval	Off/1 week/4 week/2000H	
		Menu Mode	Basic Menu/Advanced Menu	
		Language	English/Deutsch/Français/Italiano/Español/Svenska/日本語/中文	

## 5. Using On-Screen Display

MENU	ITEM		
Installation	Orientation	Desktop Front/Ceiling Rear/Desktop Rear/Ceiling Front	
	Communication Speed	4800bps/9600bps/19200bps/38400bps	
	Menu Color Select	Color/Monochrome	
	Display Time	Manual/Auto 5s/Auto 15s/Auto 45s	
	Background	Blue/Black/Logo	
	Security	Off/On	
	Control Panel Lock	Off/On	
	DynamicBlack	Off/On	
	Remote Sensor	Front/Back, Front, Back	
	LAN Settings	DHCP	Enable/Disable
		IP address	
		Subnet Mask	
		Gateway	
		DNS server	
Apply settings			
Standby Mode	Normal/Power-saving		
PC Control	PC CONTROL/LAN		
Options	Auto Start	Off/On	
	Power Management	Off/0:05/0:10/0:20/0:30	
	Screen Trigger	Off/On	
	Fan Mode	Auto/High	
	Default Source Select	Last/Auto/Computer1/Computer2/Computer3/ Component/Video/S-Video	
	Color System		
	Video	Auto/NTSC/PAL/SECAM	
	S-Video	Auto/NTSC/PAL/SECAM	
	Filter Message	Off/100[H]/200[H]/500[H]/1000[H]	
	Information	Usage Time	Lamp 1 Life Remaining, Lamp 2 Life Remaining
Lamp 1 Hours Used, Lamp 2 Hours Used			
Filter Hours Used			
Source	Input Terminal		
	Source Name		
	Horizontal Frequency		
	Vertical Frequency		
	Video Type		
	Sync Type		
	Sync Polarity		
	Scan Type		
LAN	IP Address, Subnet Mask, Gateway, MAC Address		
Version	Product, Serial Number, Firmware, Data		
Reset	Current Signal, All Data, Clear Lamp 1 Hours, Clear Lamp 2 Hours, Clear Filter Hours		

### 3 Menu Elements

Some menus and windows contain large amounts of information in a small area. Refer to the following guide to navigate through options more easily.

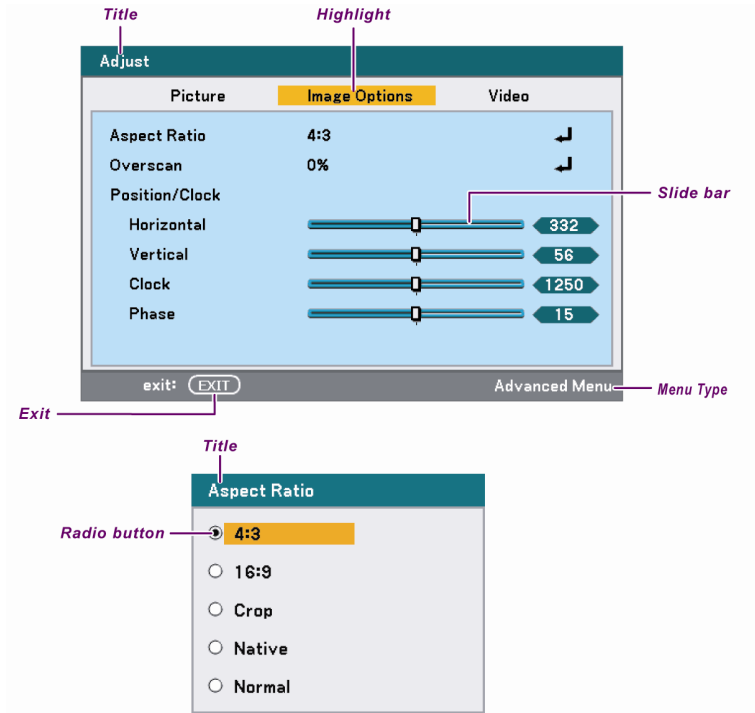

Menu windows or dialog windows typically contain the following elements:

LABEL	ITEM	DESCRIPTION
1.	Title	Indicates the menu title.
2.	Highlight	Indicates the selected menu or item.
3.	Menu type	Advanced Menu or Basic Menu.
4.	Radio button	Use this round button to select an option in a dialog box.
5.	Slide bar	Indicates settings or the direction of adjustment.
6.	Exit	Return to the previous menu.

## 5. Using On-Screen Display

### ④ Source Menu Descriptions and Functions

The Source menu displays all supported image sources.

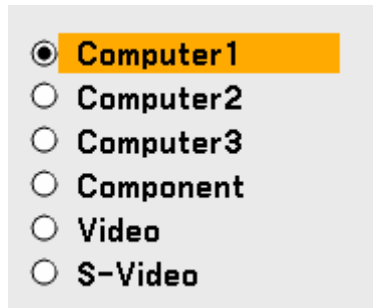

Select the required source from the menu using ▲ or ▼ and press **Enter** to confirm.

ITEM	DESCRIPTION
Computer 1	Select the source connected to the Computer 1 input (see Connecting Your PC or Macintosh Computer on page 28).
Computer 2	Select the source connected to the Computer 2 input (see Connecting Your PC or Macintosh Computer on page 28).
Computer 3	Select the source connected to the Computer 3 input (see Connecting Your PC or Macintosh Computer on page 28).
Component	Select the source connected to the Component input (see Connecting Your DVD Player with Component Output on page 31).
Video	Select the source connected to the Video input (see Connecting Your VCR or Laser Disc Player on page 32).
S-Video	Select the source connected to the S-Video input (see Connecting Your VCR or Laser Disc Player on page 32).

## ⑤ Adjust Menu Descriptions and Functions

The Adjust menu contains overall projector settings for image output such as sharpness, overscan and color matrix.

Three tabs are accessible through the Adjust menu, Picture, Image Options and Video.

### Picture menu

The picture menu is used to alter picture settings and can be accessed from the Adjust menu.

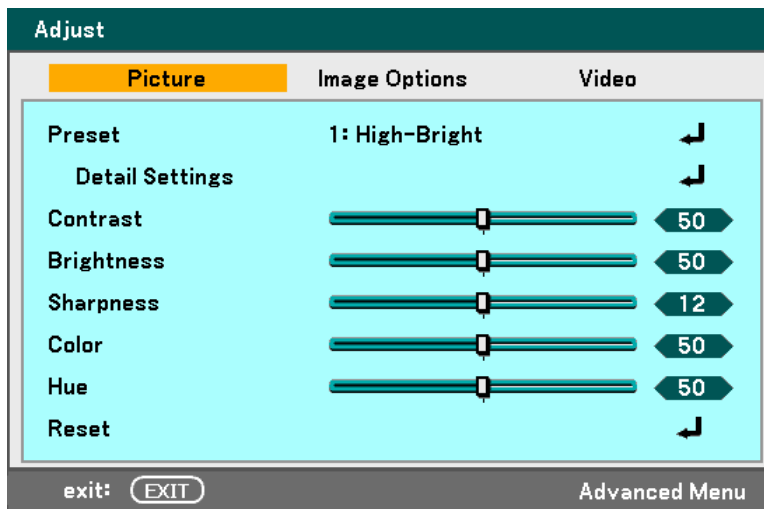

The following table lists all functions with a description and the default setting.

ITEM	DESCRIPTION
Preset	Select a set of preset values using ◀or▶ from the list. Notice that the below values will change depending on the preset selected.
Detail Setting	See ⑥ Detail Settings Menu Descriptions and Functions on page 69.
Contrast	Adjust the Contrast value using ◀or▶ to highlight the differences between light and dark areas of the picture.
Brightness	Adjust the Brightness value using ◀or▶ to lighten or darken the picture.
Sharpness	Adjust the Sharpness value using ◀or▶ to sharpen or blur the borders between colors and objects.
Color	Adjust the Color value using ◀or▶ to increase or decrease color input to the picture.
Hue	Adjust the Hue value using ◀or▶ to increase or decrease the color Hue of the picture.
Reset	The settings and adjustments for Picture will be returned to factory settings.

## 5. Using On-Screen Display

### Image Options Menu

The Image Options menu is used to configure image options such as screen positioning and aspect ratio. Access the image options menu in the Adjust menu.

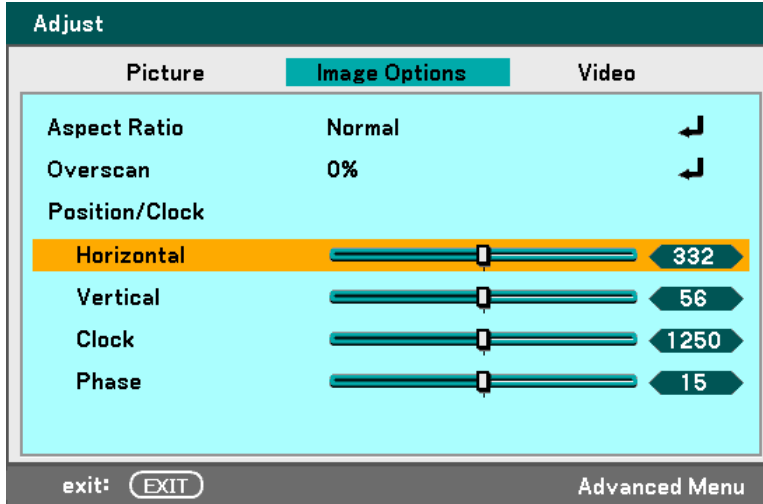

The following table lists all functions with a description and the default setting.

ITEM	DESCRIPTION
Aspect Ratio	Select Aspect Ratio using ◀or▶ from the list (see page 65).
Overscan	Set the Overscan value using ◀or▶ (see page 65).
Position/ Clock	<p>Adjust the Position/Clock values using the slides.</p> <p>Horizontal: Adjusts the image location horizontally using ◀or▶.</p> <p>Vertical: Adjusts the image location vertically using ◀or▶.</p> <p>Clock: Fine tune a computer image or remove any vertical banding that might appear.</p> <p>Phase: Adjust the clock phase or reduce video noise, dot interference or cross talk.</p> <div style="border: 1px solid black; padding: 5px; margin-top: 10px;"> <p><b>Note:</b> Only use the Phase settings after the clock settings have been modified.</p> </div>

### *Aspect Ratio*

Aspect Ratio alters the appearance or Ratio of the projected image.

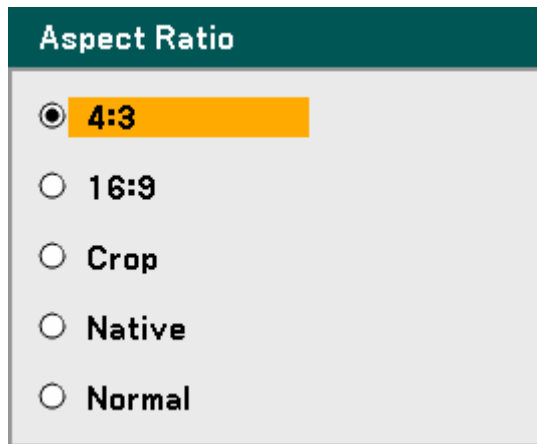

**4:3** – Standard TV screen (4:3), proportionally four units wide for every three units high, no matter the size of the screen.

**16:9** – A wide-screen aspect ratio for video.

**Crop** – Crop the image.

**Native** – Displays the current image in its true resolution.

**Normal** – Displays the current image in its aspect ratio.

### *Overscan*

Video images normally exceed the size of the display screen. The edge of the picture may or may not be displayed correctly. The border area that is cropped can be adjusted by using the Overscan menu.

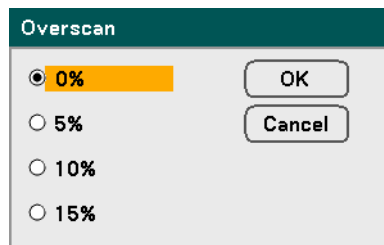

Set the overscan percentage between 0 – 15% to compensate for different screen sizes.

## 5. Using On-Screen Display

### *Video Menu*

The Video menu is used to configure image options such as deinterlace and telecine. Access the Video menu in the Adjust menu.

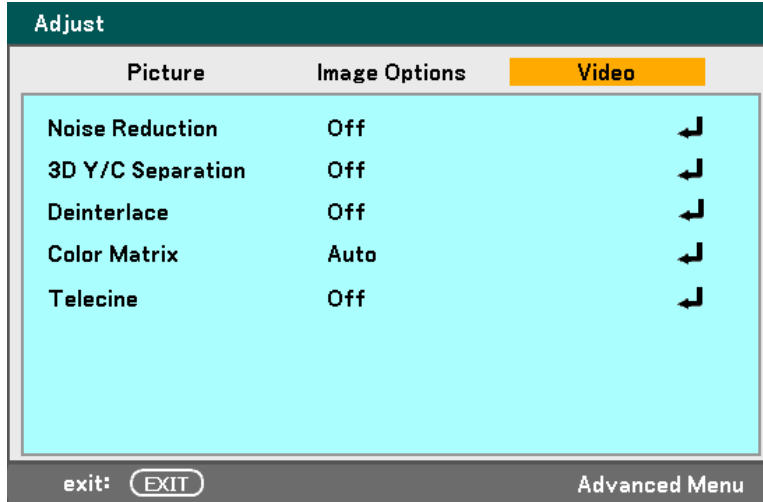

The following table lists all functions with a description and the default setting. A detailed description follows the table.

ITEM	DESCRIPTION
Noise Reduction	Select Noise Reduction mode (see page 67).
3D Y/C Separation	Select 3D Y/C Separation mode (see page 67).
Deinterlace	Select Deinterlace mode (see page 67).
Color Matrix	Select Color Matrix mode (see page 68).
Telecine	Select Telecine mode (see Telecine on page 68).

### Noise Reduction

Select the level of noise reduction required.

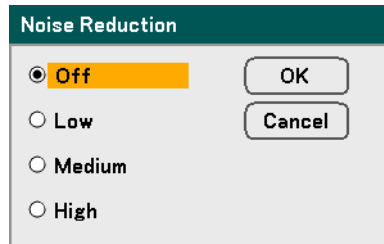

The dialog box titled "Noise Reduction" has a dark green header. It contains four radio button options: "Off" (selected and highlighted in yellow), "Low", "Medium", and "High". To the right of the options are two buttons: "OK" and "Cancel".

Range: Off, Low, Medium, High.

### 3D Y/C Separation

3D Y/C Separation separates composite signal to Y (brightness) signal and C (color) signal, and can help to produce clearer and sharper images without overlapping colors (rainbow effect).

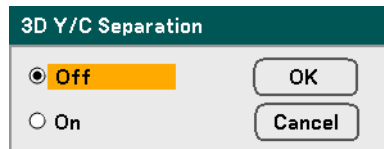

The dialog box titled "3D Y/C Separation" has a dark green header. It contains two radio button options: "Off" (selected and highlighted in yellow) and "On". To the right of the options are two buttons: "OK" and "Cancel".

Set 3D Y/C Separation On or Off.

### Deinterlace

Deinterlace converts an interlaced image to a progressive scan image.

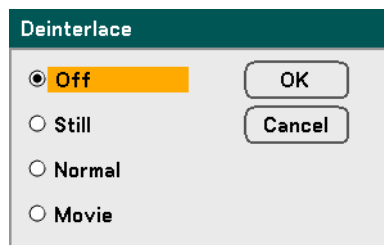

The dialog box titled "Deinterlace" has a dark green header. It contains four radio button options: "Off" (selected and highlighted in yellow), "Still", "Normal", and "Movie". To the right of the options are two buttons: "OK" and "Cancel".

Select the form of Deinterlacing required from:

**Still** – Select for stills such as slide projections or screen shots.

**Normal** – Select Normal for non-specialized projection.

**Movie** – Select for movie projection.

## 5. Using On-Screen Display

---

### Color Matrix

Color Matrices define the amount of the three-color components R (red), G (green), and B (blue) in a single point in color space.

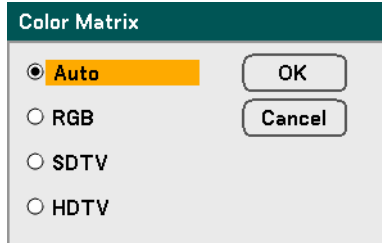

Select from the following:

**Auto** – Auto selects the color matrix.

**RGB** – Sets the color matrix to RGB, use for PC monitor or camera imaging.

**SDTV** – Sets the color matrix to SDTV, use for Standard Definition imaging.

**HDTV** – Sets the color matrix to HDTV, use for High Definition imaging.

### Telecine

Telecine aids in converting motion picture film images into video. The process adds additional frames to the picture in order to increase the frame rate.

**Note:**

*This feature is only available when deinterlace is turned on and SDTV signal is selected.*

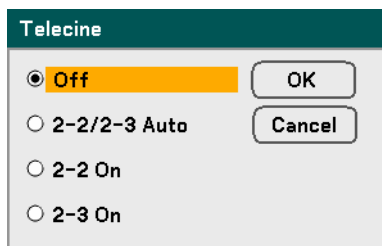

Select from the following:

**Off** – Telecine mode is turned off.

**2-2/2-3 Auto** – Detects pull-down correction method.

**2-2 On** – Uses 2-2 pull-down correction method.

**2-3 On** – Uses 2-3 pull-down correction method.

## 6 Detail Settings Menu Descriptions and Functions

The Detail Settings menu contains basic and advanced color adjustment options such as gamma correction, color contrast and color correction.

### *General*

The General tab contains general Detail Settings such as gamma correction and color temperature. Access to the General tab is through the Detail Settings menu.

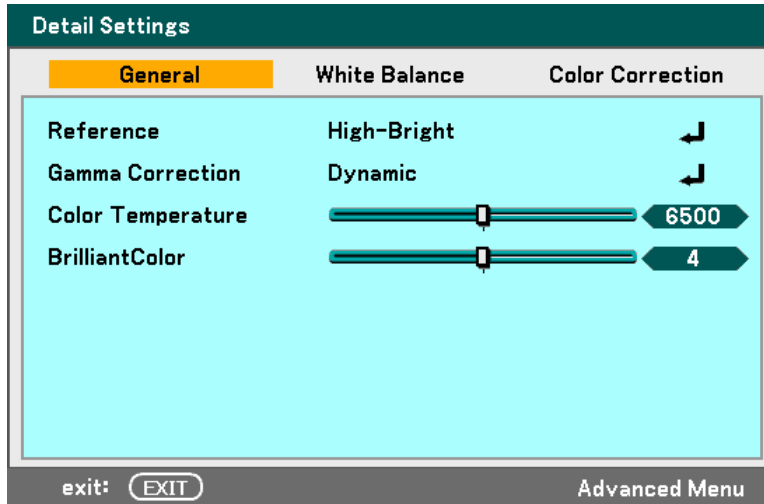

The following table lists all functions with a brief description.

ITEM	DESCRIPTION
Reference	Set Reference mode (see page 70).
Gamma Correction	Select Gamma Correction mode (see page 70).
Color Temperature	Set the color temperature value in Kelvin (K). Compensate for the amount of light available. Daylight is approximately 5500K.
BrilliantColor™	Set the BrilliantColor value. BrilliantColor extends the exposure range and sharpens detail for grain free images.

## 5. Using On-Screen Display

---

### *Reference*

The Reference mode allows the projector to differentiate between source materials for example movies, PC images or video stills.

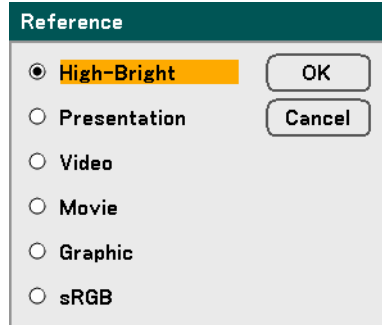

Select from the following:

**High-Bright** – Select for use in a brightly lit room.

**Presentation** – Select if the projector is to be used for presentation purposes.

**Video** – Select for video projection.

**Movie** – Select for Movie projection.

**Graphic** – Select Graphic for still images.

**sRGB** – Select for projecting PC or web page images.

### *Gamma Correction*

Gamma Correction enables adjustment to the light intensity (brightness) of an image in order to match the source more closely.

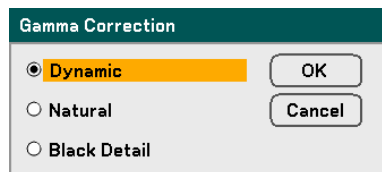

Select from the following:

**Dynamic** – Allows the projector to dynamically alter the gamma correction automatically.

**Natural** – Attempts to emulate the original source as closely as possible.

**Black Detail** – Black Detail highlights boundaries between light and dark areas of the image more clearly.

White Balance

White Balance allows the projector to compensate for different colors of light being emitted by different light sources.

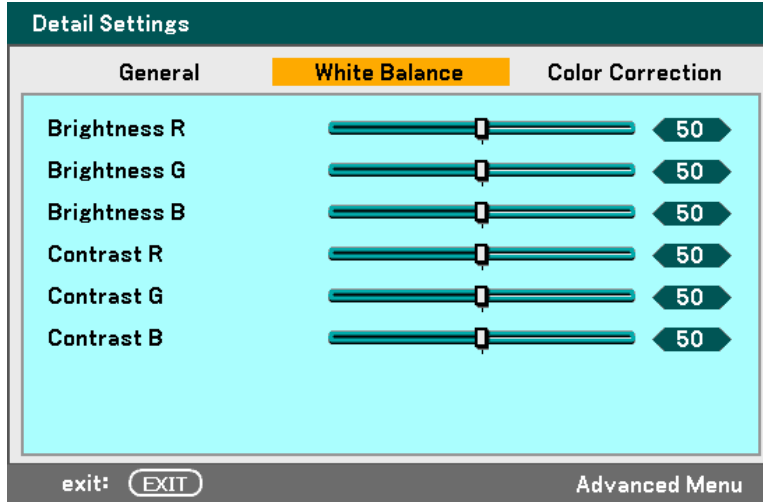

The following table lists all functions with a brief description.

ITEM	DESCRIPTION
Brightness R	Set the Brightness R value to compensate for red light sources.
Brightness G	Set the Brightness G value to compensate for green light sources.
Brightness B	Set the Brightness B value to compensate for blue light sources.
Contrast R	Set the Contrast R value to compensate for red light sources.
Contrast G	Set the Contrast G value to compensate for green light sources.
Contrast B	Set the Contrast B value to compensate for blue light sources.

## 5. Using On-Screen Display

### Color Correction

The Color Correction tab enables the adjustment of color values in an image to remove unwanted effects, improve color, characteristics or add more of a particular color.

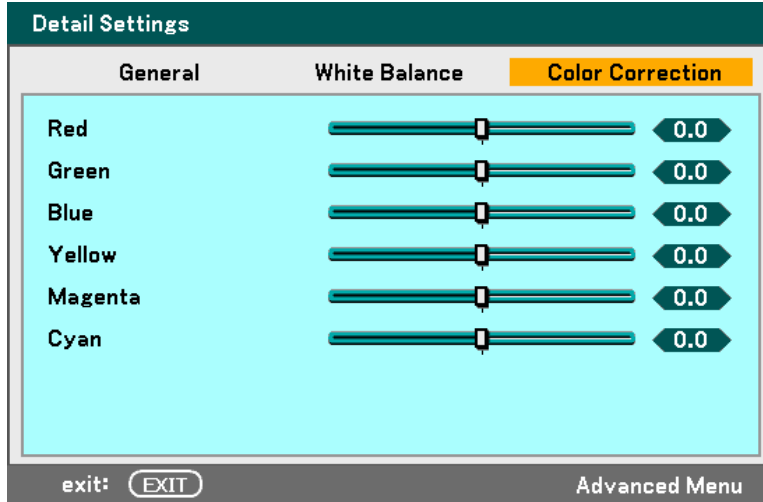

The following table lists all functions with a brief description.

ITEM	DESCRIPTION
Red	Increase or decrease the amount of red in the projected output using ◀ and ▶.
Green	Increase or decrease the amount of green in the projected output using ◀ and ▶.
Blue	Increase or decrease the amount of blue in the projected output using ◀ and ▶.
Yellow	Increase or decrease the amount of yellow in the projected output using ◀ and ▶.
Magenta	Increase or decrease the amount of magenta in the projected output using ◀ and ▶.
Cyan	Increase or decrease the amount of cyan in the projected output using ◀ and ▶.

## 7 Setup Menu Descriptions and Functions

The Setup menus contain the most often used settings during installation and options to customize the general output of the projector. Three tabs are accessible through the Setup menu, general, installation and option.

### General

The General tab contains general setup options such as lamp mode and OSD language settings and can be accessed with the projector control panel or with the remote control unit.

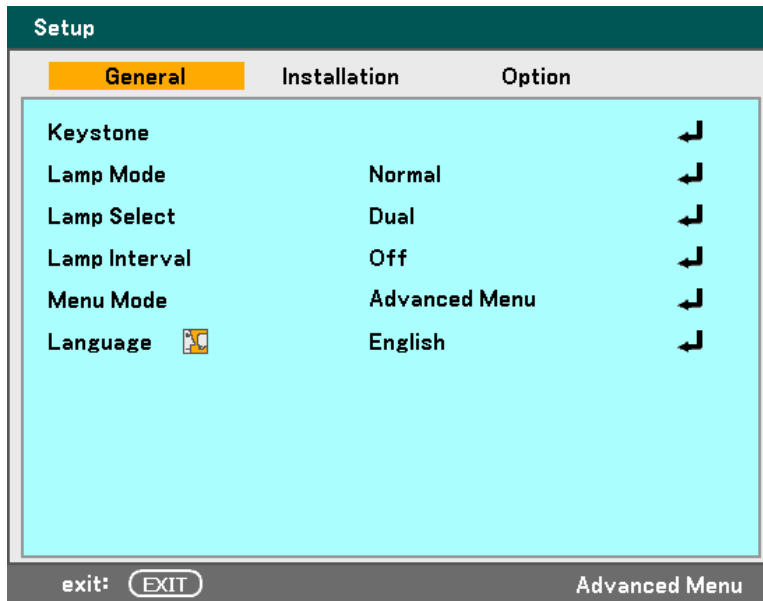

The following table lists all functions with a brief description.

ITEM	DESCRIPTION
Keystone	Adjust the Keystone trapezoid (see page 74).
Lamp Mode	Select Lamp Mode. Range: Normal or Eco.
Lamp Select	Select Lamp configuration. Range: Dual, Lamp1 or Lamp2.
Lamp Interval	Select Lamp Interval. Range: Off, 1 week, 4 weeks or 2000 hours.
Menu Mode	Select Menu Mode. Range: Advanced Menu or Basic Menu.
Language	Select the OSD language (see Language on page 76).

## 5. Using On-Screen Display

---

### *Keystone*

The keystone trapezoid can be adjusted by selecting this option.

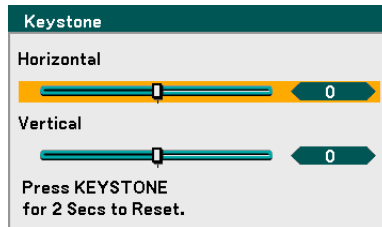

Select Horizontal or Vertical using ▲ or ▼ then, use ◀ or ▶ to adjust the projected image appearance as required.

### *Lamp Mode*

Select Normal or Eco from the lamp mode window. The lamp life can be extended by using the Eco mode and the fan noise can be reduced.

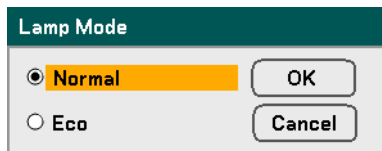

### *Lamp Select*

Select the lamps to be used for projection.

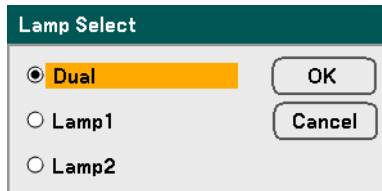

Select from the following:

**Dual** – Uses both lamps simultaneously.

**Lamp1** – Uses Lamp1 only.

**Lamp2** – Uses Lamp2 only.

### *Lamp Interval*

Lamp Interval determines the period of time after which the lamp should be swap when lamp select is not Dual.

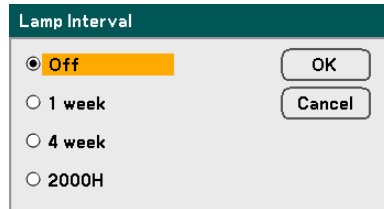

Lamp Interval

Off

1 week

4 week

2000H

OK

Cancel

Select from the following:

**Off, 1 week, 4 week and 2000H**

### *Menu Mode*

Select the Menu Mode to display.



Menu Mode

Basic Menu

Advanced Menu

OK

Cancel

Select from the following:

**Basic Menu** – Displays menus with minimum essential options. This setting is best suited to novices.

**Advanced Menu** – Displays menus with all available options. This setting is best suited to experienced operators.

## 5. Using On-Screen Display

---

### *Language*

Select the OSD language to be used.

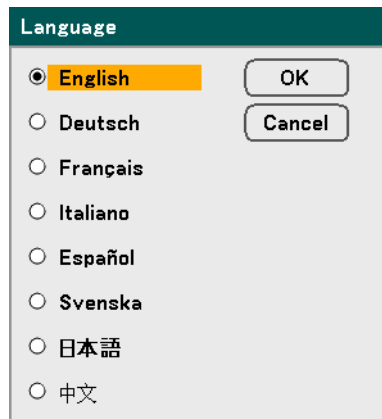

Select from the following:

- **English**
- **German**
- **French**
- **Italian**
- **Spanish**
- **Swedish**
- **Japanese**
- **Simplified Chinese**

### Installation

The Installation tab contains menu options for various setup conditions such as orientation and remote sensor mode and is accessed through the Setup menu.

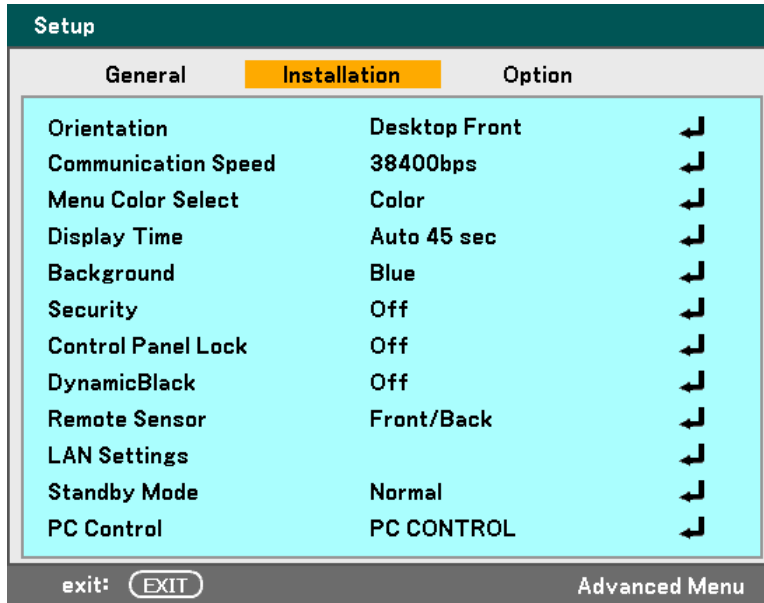

The following table lists all functions with a brief description.

ITEM	DESCRIPTION
Orientation	Select from four projection methods depending on projection site (see page 78).
Communication Speed	Select Communication Speed. Range: 4800bps, 9600bps, 19200bps, 38400bps
Menu Color Select	Select the menu color from the list. Range: color or monochrome.
Display Time	Select Display Time. Range: Manual, Auto 5s, Auto 15s, Auto 45s
Background	Select Background appearance when there is no signal. Range: blue, black or logo
Security	Set Security On/Off (see Security on page 81).

## 5. Using On-Screen Display

ITEM	DESCRIPTION
Control Panel Lock	Set Control Panel Lock On/Off.  <div style="border: 1px solid black; padding: 5px;"> <p><b>Note:</b></p> <ul style="list-style-type: none"> <li>• <i>This Control Panel Lock does not affect the remote control functions.</i></li> <li>• <i>When the control panel is locked, pressing and holding the <b>Exit</b> button on the projector cabinet for about 10 seconds. The setting will change to Off.</i></li> </ul> </div>
DynamicBlack (TM)	DynamicBlack improves the black level of the projector. Black level is the darkest part of a picture and varies between viewing devices and environments. Set DynamicBlack on/off.
Remote Sensor	Set Remote Sensor fields. Range: Front/Back, Front, Back
LAN Settings	Opens LAN preferences tab (see LAN Settings on page 84).
Standby Mode	Select Standby Mode. Range: Normal and Power-saving
PC Control	Enables the path selection for PC control. Select PC Control. Range: PC CONTROL or LAN.

### Orientation

Orientation enables you to set how the projected image is displayed.

Select from the following:

**Desktop Front** – Standard forward facing projection (Default setting).

**Desktop Rear** – Standard rear projection. Enables the projector to produce the image from behind the screen by reversing the image.

**Ceiling Front** – Forward facing ceiling mounted projection. Enables ceiling mounted projection by inverting the image.

**Ceiling Rear** – Rear ceiling mounted projection. Enables ceiling mounted projection from behind the screen by inverting and reversing the image.

## 5. Using On-Screen Display

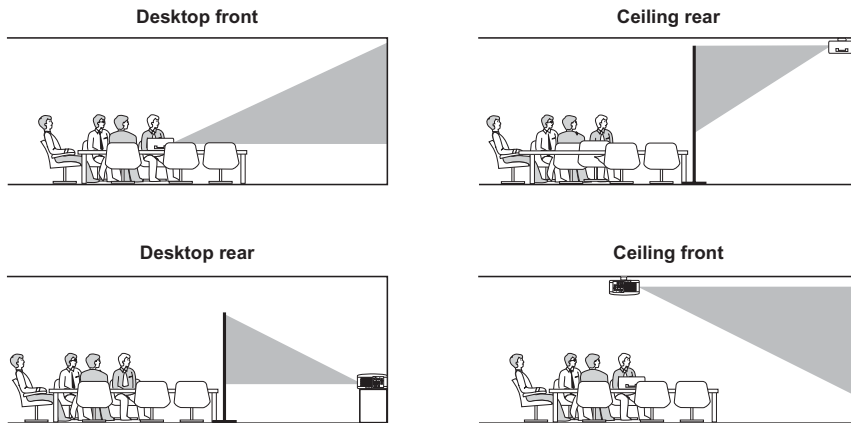

### Communication Speed

Select communication speed to set the baud rate of the connection.

**Note:**  
Longer cable connections may require lower settings.

The dialog box titled "Communication Speed" has a dark green header. It contains four radio button options: "4800bps" (selected), "9600bps", "19200bps", and "38400bps". To the right of the options are two buttons: "OK" and "Cancel".

Select from the following options:

- 4800bps
- 9600bps
- 19200bps
- 38400bps

### Menu Color Select

Select color modes to set the menu color.

The dialog box titled "Menu Color Select" has a dark green header. It contains two radio button options: "Color" (selected) and "Monochrome". To the right of the options are two buttons: "OK" and "Cancel".

Select from the following options:

## 5. Using On-Screen Display

- Color

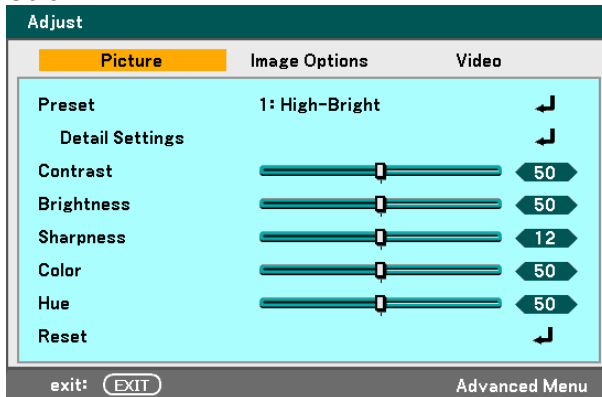

- Monochrome

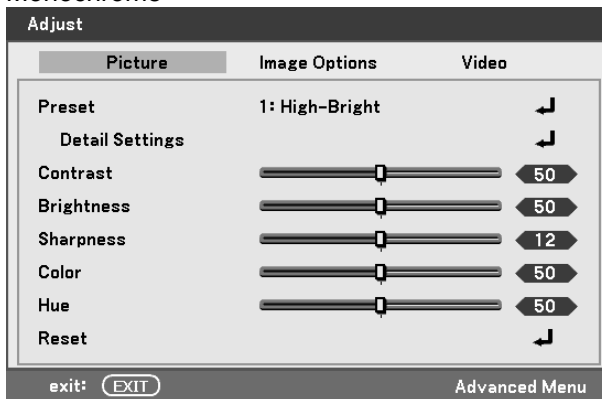

### Display Time

Sets the amount of time a menu is displayed.

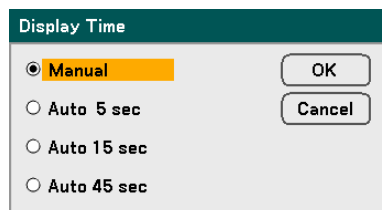

Select from the following:

**Manual** – Menus stay on screen until the **Menu** button is pressed again.

**Auto 5 secs**—Menu is displayed for 5 seconds.

**Auto 15 secs** – Menu is displayed for 15 seconds.

**Auto 45 secs** – Menu is displayed for 45 seconds.

### Background

Background enables you to display a blue/black screen when there is no signal. The default background is blue.

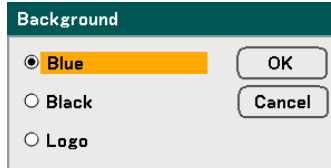

Select from the following:

- Blue
- Black
- Logo

### Security

See [7 Preventing the Unauthorized Use of the Projector on page 53](#).

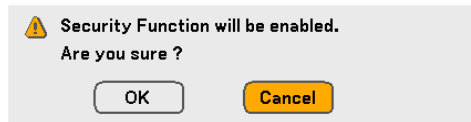

### Control Panel Lock

Turn On/Off the Key Lock function for cabinet buttons.

**Note:**

- This Control Panel Lock does not affect the remote control functions.
- When the control panel is locked, pressing and holding the **Exit** button on the projector cabinet for about 10 seconds. The setting will change to Off.



### DynamicBlack

DynamicBlack enables you to improve the black level of the projector.

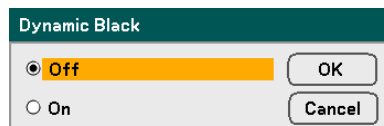

## 5. Using On-Screen Display

---

### Remote Sensor

Set the operating range for the wireless remote control.

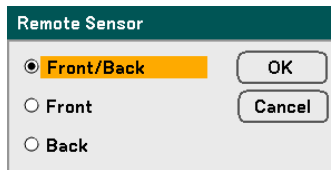

Select from the following:

- Front/Back
- Front
- Back

### LAN Settings

See LAN Settings on page 84.

### Standby Mode

There are two standby modes available: Normal and Power-Saving. Power-Saving mode allows you to put the projector in the standby condition to consume less power than Normal.

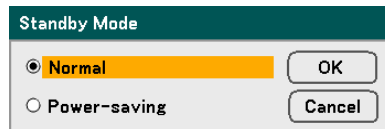

**Note:**

*Be sure to connect the projector and computer while the projector is in standby mode and before turning on the computer.*

Select from the following:

- Normal
- Power-saving

**Note:**

*The HTTP server functions are not available during Power-saving mode.*

*The MONITOR OUT function is not available during Power-saving mode.*

*Control through the PC Control connector and LAN mode is not available during Power-saving mode. For PC control and LAN mode of the projector it is recommended to leave the projector in the Normal mode.*

*Normal mode: Power indicator: Orange light*

*Status indicator: Green light*

*Power-saving mode: Power indicator: Orange light*

*Status indicator: Off*

### PC Control

This function enables you to select the path for PC Control (see ⑤ PC Control Codes and Cable Connections on page 118).

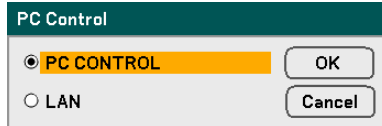

**Note:**

*In the LAN mode, Communication Speed function is not available.*

Select from the following:

- PC CONTROL
- LAN

## 5. Using On-Screen Display

### LAN Settings

The LAN settings tab is accessed by using the Setup/Installation tab and contains general LAN settings.

The screenshot shows a terminal-style interface for LAN settings. The title bar is 'LAN Settings'. Below it is a yellow 'Setup' tab. The main area is light blue and contains the following settings:

- DHCP:**  Enable  Disable
- IP Address:** 192 . 168 . 10 . 10
- Subnet Mask:** 255 . 255 . 255 . 0
- Gateway:**  Enable  Disable  
0 . 0 . 0 . 0
- DNS Server:**  Enable  Disable  
0 . 0 . 0 . 0
- Apply Settings:** ↩

At the bottom, there is a grey bar with 'exit: EXIT' on the left and 'Advanced Menu' on the right.

The following table lists all functions with a description and the default setting.

ITEM	DESCRIPTION
DHCP	Select either a static IP or DHCP IP setting by selecting the appropriate radio button.
IP Address	Displays the IP address.
Subnet Mask	Displays the subnet mask.
Gateway	Enable or disable the network gateway setting. Click on the radio button to change the setting.
DNS Server	Enable or disable the DNS server settings. Click on the radio button to change the setting.
Apply Settings	Apply and save settings.

### Options

The Options tab contains miscellaneous setup menu settings such as Power Management and Default Source Select and can be accessed by using the Setup Menu.

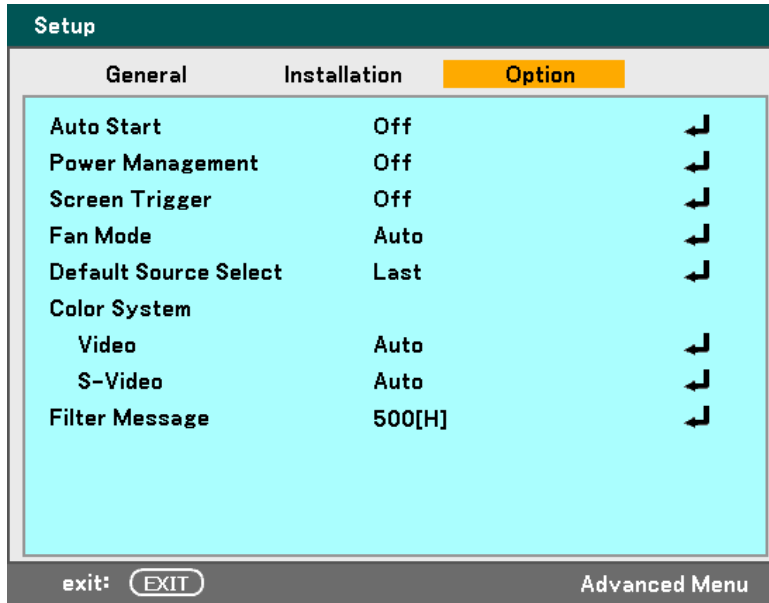

The following table lists all functions with a description and the default setting.

ITEM	DESCRIPTION
Auto Start	Set this item on to enable the projector to power up when AC plug in. Range: on or off
Power Management	Select the amount of time the projector remains idle before powering down. Range: Off, 0:05, 0:10, 0:20, 0:30
Screen Trigger	Set this item to On to enable the projector to automatically lower the projection screen when powering on. Range: on or off
Fan Mode	Select Fan Mode. Range: Auto or High (see page 86)
Default Source Select	Select the default source for projection. Range: Last, Auto, Computer1, Computer2, Computer3, Component, Video, S-Video

## 5. Using On-Screen Display

ITEM	DESCRIPTION
Color System	Select the default Color System to use for Video or S-Video input. Range: Auto, NTSC, PAL, SECAM
Filter Message	Set this item to on to have the projector display a message when the air filter needs servicing. Range: Off, 100[H], 200[H], 500[H], 1000[H]

### Auto Start

Auto Start enables the projector to start automatically when the power cable is connected to an active power outlet and the main power switch is on. This eliminates the need to always use the **POWER** (ON/STANDBY) button on the remote control or projector cabinet. To use the Auto Start function, you must first press the main power switch to On before connecting the power cable.



#### Note:

- When the projector is off by using the **POWER** button (or put in the standby mode) and the power cable is disconnected, Auto Start will not activate after power (AC) is applied.
- When the projector is off by using the **Direct Power Off** function or after the power (AC) is removed (no standby mode), Auto Start will be activated after power (AC) is applied.
- The **Direct Power Off** function means you can turn off the power (AC) to the projector by using a power strip equipped with a switch and a breaker.

### Power Management

Power Management enables the projector to automatically turn off if there is no signal received by any input.

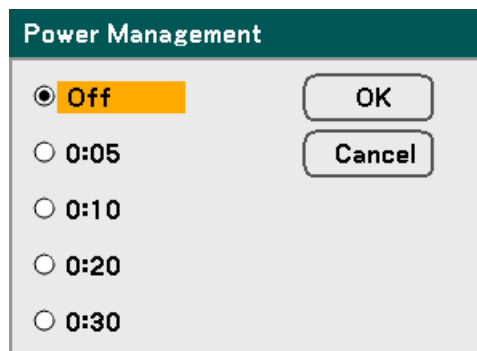

Select from the following:

- Off
- 5 minutes
- 10 minutes
- 20 minutes
- 30 minutes

### *Screen Trigger*

Set Screen Trigger to On to enable the projector to automatically lower the projection screen when powering on. When powering off, Screen trigger stops sending a low voltage trigger to the screen controller and the screen goes up.

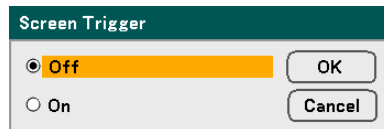

The 'Screen Trigger' OSD menu is displayed with a dark green header. It contains two radio button options: 'Off' (selected) and 'On'. To the right of the 'Off' option is an 'OK' button, and to the right of the 'On' option is a 'Cancel' button.

### *Fan Mode*

Fan Mode is used to set the speed of the internal cooling fan. Set Fan Speed to High in altitudes over 1500 meters (5000 feet).



The 'Fan Mode' OSD menu is displayed with a dark green header. It contains two radio button options: 'Auto' (selected) and 'High'. To the right of the 'Auto' option is an 'OK' button, and to the right of the 'High' option is a 'Cancel' button.

The Fan Mode option default is **Auto**, which enables the projector to automatically detect fan requirements. For higher temperature locations or prolonged use, the **High** option is available providing greater cooling capacity.

### *Default Source Select*

The Default Source is the image source that the projector will search for automatically on startup.

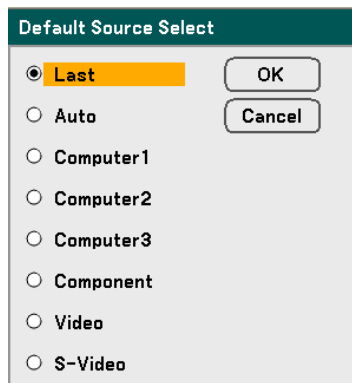

The 'Default Source Select' OSD menu is displayed with a dark green header. It contains a list of radio button options: 'Last' (selected), 'Auto', 'Computer1', 'Computer2', 'Computer3', 'Component', 'Video', and 'S-Video'. To the right of the 'Last' option is an 'OK' button, and to the right of the 'Auto' option is a 'Cancel' button.

## 5. Using On-Screen Display

---

**Last** – Uses the most recently used image source.

**Auto** – Auto detects the default image source.

**Computer1/2/3** – Uses Computer1, 2 or 3 as the default image source.

**Component** – Uses last component as the default image source.

**Video** – Uses last video input as default image source.

**S-Video** – Uses last S-video input as default image source.

### Color System

Color System enables you to select video standards manually. In the normal condition, select **Auto** and the projector will automatically detect the video standard. When the projector has difficulty detecting the video standard, you can select the appropriate video standard from the menu. This must be done for Video and S-Video Connector separately.

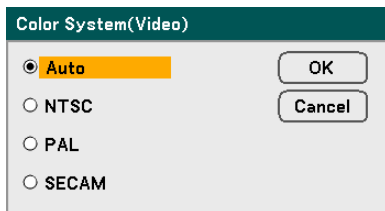

Color System(Video)

Auto

NTSC

PAL

SECAM

OK

Cancel

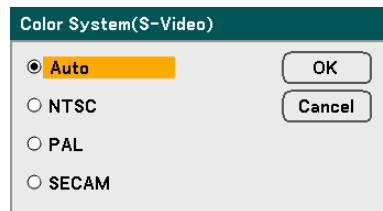

Color System(S-Video)

Auto

NTSC

PAL

SECAM

OK

Cancel

### Filter Message

Set Filter Message to on to have the projector display a message when the air filter needs servicing.

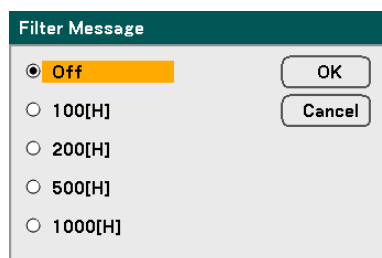

Filter Message

Off

100[H]

200[H]

500[H]

1000[H]

OK

Cancel

The message below shows when this function is activated.

Please clean filter.

## ⑧ Information Menu Descriptions and Functions

The information menu provides only screens to access details quickly. The Information menu contains four distinct tabs.

### Usage Time

The Usage Time tab displays information about lamp usage and remaining lamp life.

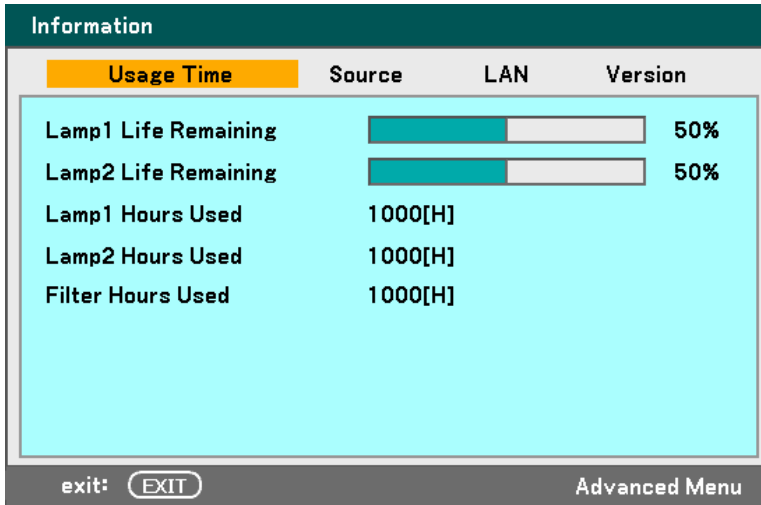

The following table lists all items with a description.

ITEM	DESCRIPTION
Lamp1 Life Remaining	Displays the Lamp1 life remaining as a percentage.
Lamp2 Life Remaining	Displays the Lamp2 life remaining as a percentage.
Lamp1 Hours Used	Displays the Lamp1 total usage in hours.
Lamp2 Hours Used	Displays the Lamp2 total usage in hours.
Filter Hours Used	Displays the filter total usage in hours.

## 5. Using On-Screen Display

### Source

The Source tab displays various source and frequency values at a glance.

Information			
Usage Time	Source	LAN	Version
Input Terminal	Computer2		
Source Name	1024x768		
Horizontal Frequency	48.36[kHz]		
Vertical Frequency	60.00[Hz]		
Video Type	---		
Sync Type	Separate Sync		
Sync Polarity	H:(-)V:(-)		
Scan Type	Non-Interlace		

exit:  Advanced Menu

The following table lists all items with a description.

ITEM	DESCRIPTION
Input Terminal	Displays the Input Terminal that is presently being used (see Default Source Select on page 87).
Source Name	Displays the Source name of the signal presently being used (see Options, Color System on page 85).
Horizontal Frequency	Displays Horizontal Frequency in KHz.
Vertical Frequency	Displays Vertical Frequency in Hz.
Video Type	Displays Video type.
Sync Type	Displays Sync Type.
Sync Polarity	Displays Sync Polarity.
Scan Type	Displays Scan Type.

### LAN

The LAN tab displays LAN settings as previously defined (see LAN Settings on page 84).

Information			
Usage Time	Source	LAN	Version
IP Address	192.168.10.10		
Subnet Mask	255.255.255.0		
Gateway	0.0.0.0		
MAC Address	00:30:13:04:9E:01		

exit:  Advanced Menu

## 5. Using On-Screen Display

### Version

The Version tab displays all the version and product details of the projector and associated software.

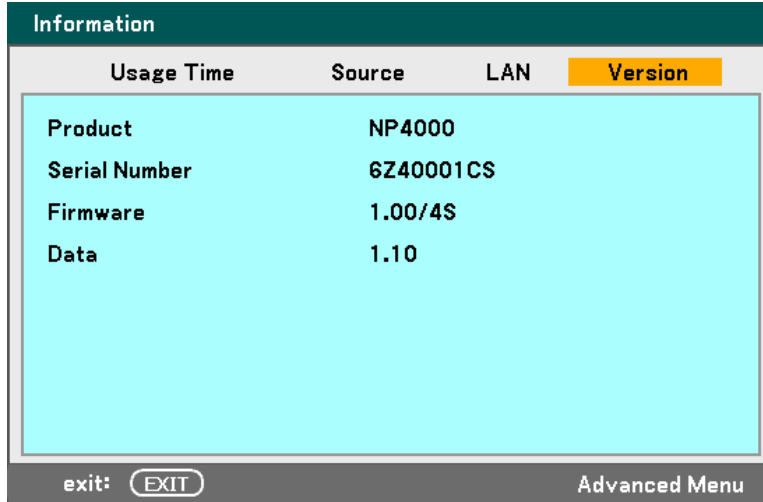

The following table lists all items with a description.

ITEM	DESCRIPTION
Product	Displays Product ID.
Serial Number	Displays projector Serial Number.
Firmware	Displays Firmware version and Color Wheel currently installed (4-seg or 6-seg).
Data	Displays Data version.

## 9 Reset Menu Descriptions and Functions

Occasionally, circumstances may require that factory defaults are reset, for demonstration purposes for example, or when components are replaced.

The Reset menu contains options for returning settings to the factory default and is accessed via the Main menu.

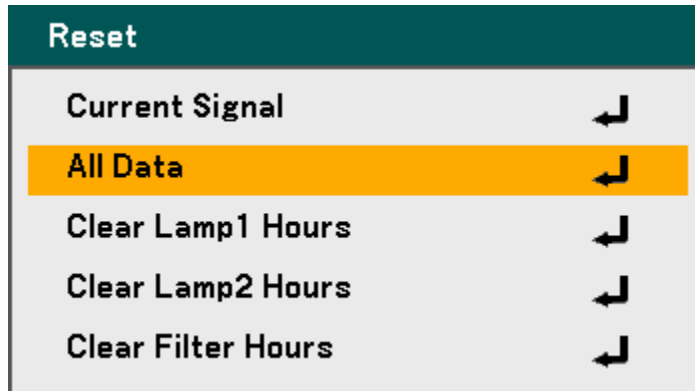

The following table lists all items with a description.

ITEM	DESCRIPTION	
Current Signal	Reset the adjustments for current signal to factory preset levels. All items in <b>Adjust</b> can be reset.	
All Data	Resets all options to factory default regardless of when they were changed. Reset all the adjustments and settings for all the signals to the factory preset except <b>Language, Background, Control Panel Lock, Security, LAN Mode, Communication Speed, Lamp Life Remaining, Lamp Hours Used, and Filter Hours Used.</b>	
Clear Lamp1 Hours	Reset lamp1 hours	These options should only be used when components are cleaned or replaced (see 6. Maintenance on page 94)
Clear Lamp2 Hours	Reset lamp2 hours	
Clear Filter Hours	Reset filter hours	

## 6. Maintenance

---

### ① Cleaning the projector

#### Cleaning the Cabinet

Refer to the following guide to clean the projector cabinet.

1. Wipe off dust with a clean dampened cloth.
2. Moisten the cloth with warm water and mild detergent and wipe the cabinet.
3. Rinse all detergent from the cloth and wipe the projector again.

#### CAUTION



To prevent discoloration or fading of the case, do not use abrasive alcohol-based cleaners.

#### Cleaning the Lens

Refer to the following guide to clean the projector lens.

1. Apply a little optic lens cleaner to a clean, lint free cloth (do not apply the cleaner directly to the lens).
2. Lightly wipe the lens in a circular motion.

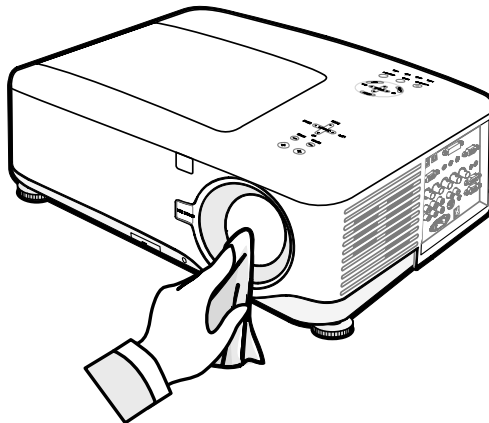

#### CAUTION



Do not use abrasive cleaners or solvents.

To prevent discoloration or fading, avoid getting cleaner on the projector case.

### Cleaning the Filters

The projector uses three filters to keep the fans free of dust and other particles, and should be cleaned every 500 hours of operation. In dustier environments, it is recommended to clean the filters more frequently. If the filter is dirty or clogged, your projector may overheat. When the message below is displayed the filters must be cleaned.

**Please clean filter.**

**Note:**

When the **Please clean filter** message is displayed, please clean or replace all three filters at the same time to synchronize the hours used display. The Filter Message item should be enabled in the Options menu. Refer to Options on page 85.

Refer to the following guide to clean the filters.

1. Lift the projector to expose the underside to locate the first filter. See the drawing on the right.

**Note:** Only clean the outside of the exhaust vents with a vacuum cleaner.

#### Bottom view

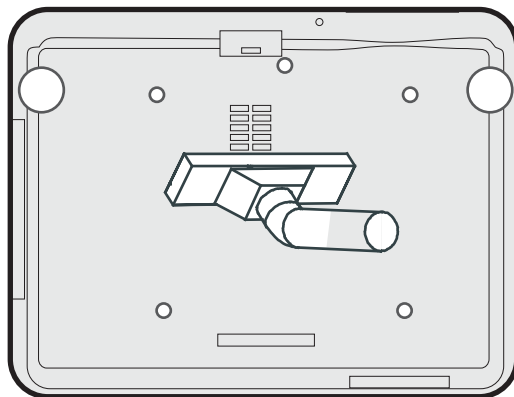

2. The left-hand filter can be accessed as shown.

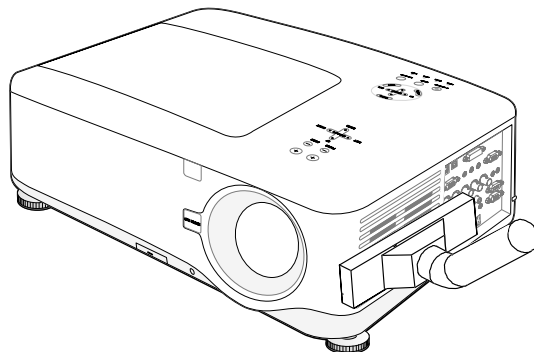

## 6. Maintenance

---

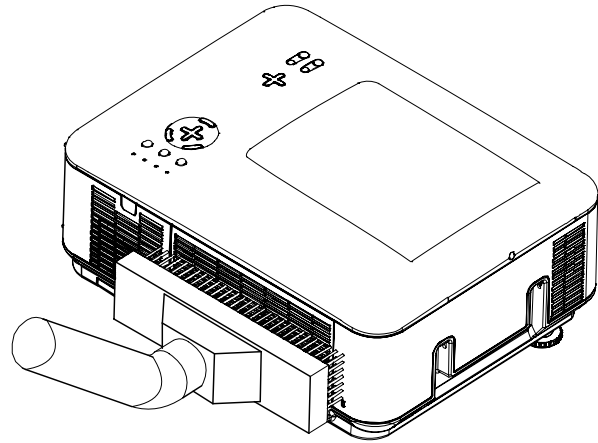

3. The rear filter can be accessed as shown.

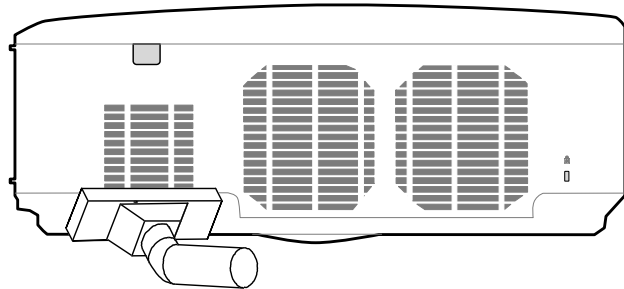

Once the filters are cleaned, please reset the filter hours via the **Clear Filter Hours** option in the **Reset Menu Descriptions and Functions** on page [93](#).

**Note:**

*Using the projector without the air filter fitted inside, dirt and dust are sucked into the projector, causing failure.*

### ② Replacing Consumable Parts

During the course of normal usage, consumable parts become worn out resulting in reduced performance. The following guides detail how to replace the various consumable parts within the projector quickly and safely.

Before replacing any of the parts, please take note of the following:

- Ensure that the projector is turned off and disconnected from the power supply.
- Ensure that the projector is in a clean, stable position before replacing parts.
- Allow at least one hour after shutdown for the projector to cool before attempting to replace any consumable parts.
- Do not interchange Lamp 1 and Lamp 2 after the projector has been used once. Doing so will not allow the projector to display the correct lamp usage hours.
- A minimum space is required for replacement. See page 25 and 98 for more details.

#### Replacing the Filters

When the lamps are replaced, the filters should also be replaced, not cleaned.

Refer to the following guide to replace the filters.



**CAUTION:**

Do not drop the projector on your hand or fingers while lifting the projector to replace the filters. Doing so could injure your hand or fingers.

**Note:**

*The filters on the side and the rear are located on the bottom.*

1. Gently slide the filter covers in the direction shown.

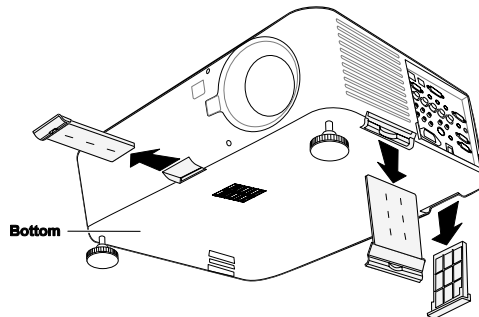

2. Lift the foam from all three filters in the direction shown. Remove completely from the filter cover and discard.

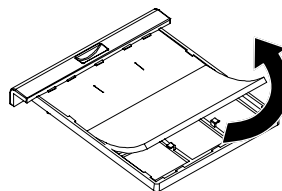

## 6. Maintenance

---

3. Insert replacement foam and press down firmly.

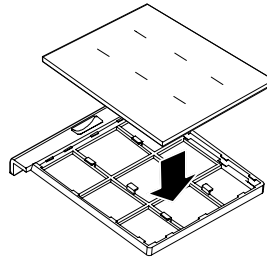

4. Replace the filter covers by pushing gently in the direction shown.

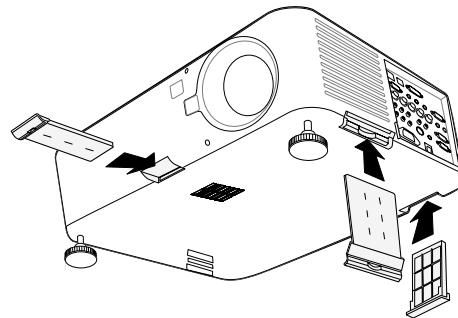

Once the filters are replaced, please reset the filter hours via the **Clear Filter Hours** option in the **Reset Menu Descriptions and Functions** on page [93](#).

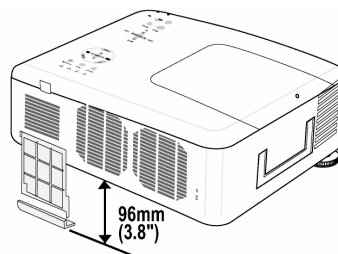
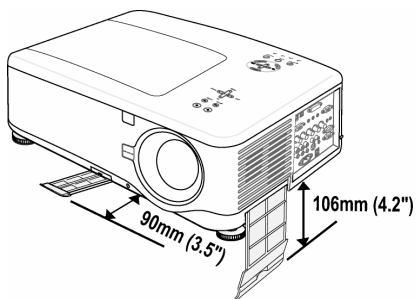

### Replacing the Lamps

When a lamp reaches the end of its usable life, the following message is displayed. Replace the lamp.

**The lamp has reached the end of its usable life.  
Please replace the lamp.**

The projection lamps should be replaced when they burn out. They should only be replaced with a certified replacement part, contact your local dealer if unsure.

**Note:**

- 1. Lamps are positioned differently. Take care not to force the lamps when replacing.*
- 2. Installation of both lamp modules (Lamp 1 and Lamp 2) is required to operate the projector in dual or single lamp mode. If only a single lamp module is installed, the projector's lamp will not turn on and will appear as a lamp failure*
- 3. Lamps last approximately 2000-2100 hours (2500-2600 hours in Eco mode) and the End of lamp life message is displayed during the lamps' final 100 hours of operational life. Please replace during 2000-2100 hour.*

**Important:**

- 1. The lamp contains a certain amount of mercury and should be disposed of according to local ordinance regulations.*
- 2. Avoid touching the glass surface of the new lamp: doing so may shorten its operation life.*
- 3. The lamp's useful life ends and projector could not turn on over 2100 hours. Please have the projector serviced.*

## 6. Maintenance

To replace the lamp, refer to the following guide.

1. Loosen the screw on the lamp cover (A), and remove the lamp cover as shown (B).

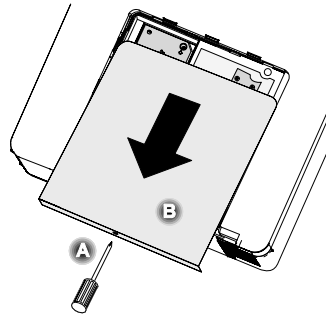

2. Loosen the two captive screws (A) on the lamp module. Lift the module handle up (B) in the direction shown.

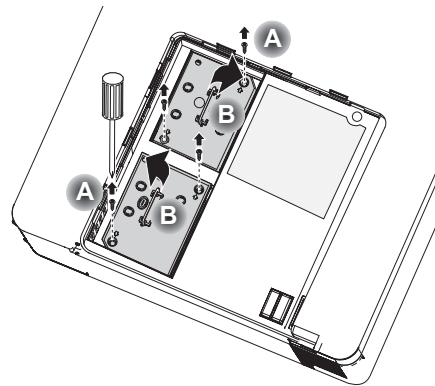

3. Pull firmly on the module handle in the direction shown to remove the lamp.

4. Reverse steps 1 to 3 to install the new lamp module and replace the lamp cover.

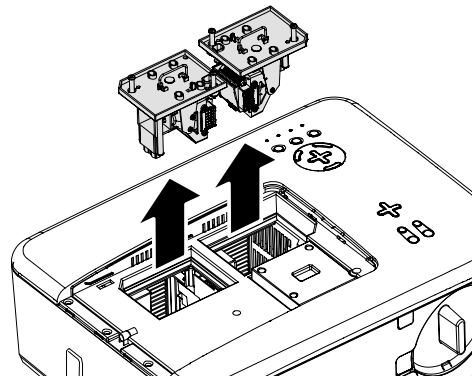

**Note:**

*The filters should be replaced when replacing the lamp modules.*

### Resetting the Lamp Hours Counter

After replacing the lamp(s), the lamp hour counter(s) should be reset to zero. Refer to the following guide:

1. Press the **Menu** button on the OSD control panel or Remote Control to open the Main menu.

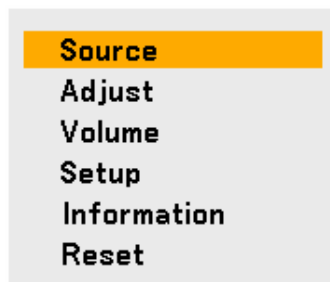

2. Press the **▲** or **▼** button to move to the **Reset** menu and press **Enter**.

3. The **Reset** menu is displayed. Select **Clear Lamp 1** or **Clear Lamp 2** as required using **▲** or **▼** and press **Enter**.

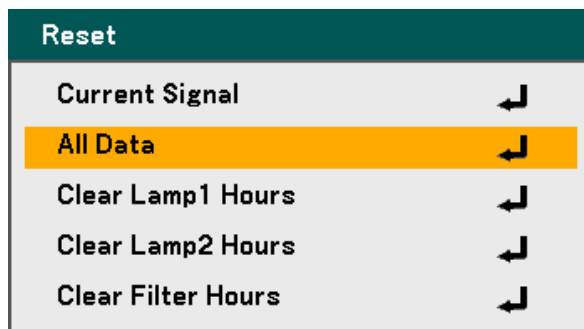

4. A confirmation box is displayed. Select **OK** using **◀** or **▶** and press **Enter** to reset the selected Lamp hours to zero.



# 7. Appendix

## ① Using the Optional Remote Mouse Receiver (NP01MR)

The optional remote mouse receiver enables you to operate your computer's mouse functions from the remote control. It is a great convenience for clicking through your computer-generated presentations.

### Connecting the remote mouse receiver to your computer

If you wish to use the remote mouse function, connect the mouse receiver and computer. The mouse receiver can be connected directly to the computer's USB port (type A).

**Note:**

*Depending on the type of connection or OS installed on your computer, you may have to restart your computer or change your computer settings.*

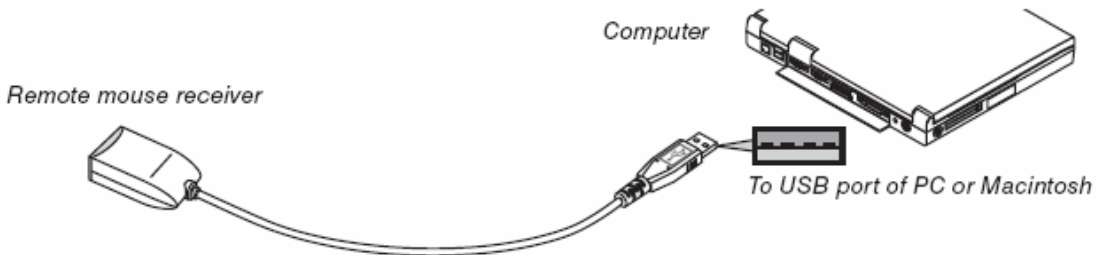

### When operating a computer through the remote mouse receiver

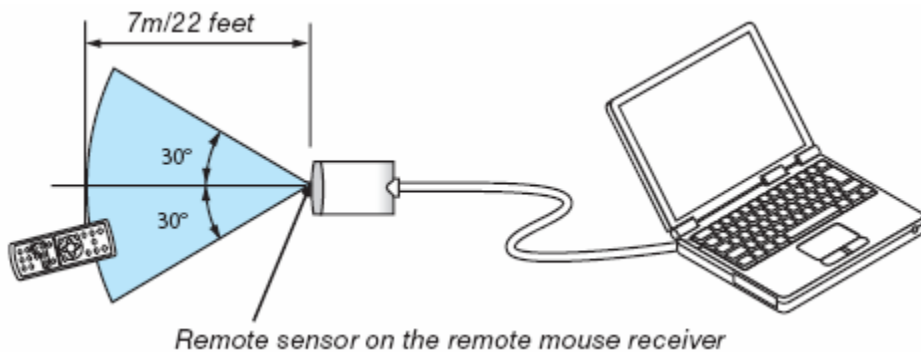

### When connecting using the USB terminal

The mouse receiver can only be used with a Microsoft Windows 98/Me/XP\*/2000 PC system or a Mac OS X 10.0.0 or later operating system.

**Note:**

*In Windows XP, if the mouse cursor will not move correctly, do the following: Clear the Enhance pointer precision check box underneath the mouse speed slider in the Mouse Properties dialog box [Pointer Options tab].*

**Note:**

*Wait at least 5 seconds after disconnecting the mouse receiver before reconnecting it and vice versa. The computer may not identify the mouse receiver if it is repeatedly connected and disconnected in rapid intervals.*

### Operating your computer's mouse from the remote control

You can operate your computer's mouse from the remote control.

PAGE UP/DOWN Button – scrolls the viewing area of the window or to move to the previous or next slide in PowerPoint on your computer.

SELECT ▲▼◀▶ Buttons – moves the mouse cursor on your computer.

MOUSE L-CLICK Button – works as the mouse left button.

MOUSE R-CLICK Button – works as the mouse right button.

**Note:**

*When you operate the computer using the SELECT ▲▼◀▶ buttons with the menu displayed, both the menu and the mouse pointer will be affected. Close the menu and perform the mouse operation.*

### About Drag Mode

By pressing the MOUSE L-CLICK or R-CLICK button for 2 or 3 seconds then releasing, the drag mode is set and the drag operation can be performed simply by pressing the SELECT ▲▼◀▶ buttons. To drop the item, press the MOUSE L-CLICK (or R-CLICK) button. To cancel it, press the MOUSE R-CLICK (or L-CLICK) button.

*Note:*

*You can change the Pointer speed on the Mouse Properties dialog box on the Windows. For more information, see the user documentation or online help supplied with your computer.*

## 7. Appendix

### ② Troubleshooting

#### *Indicator Messages*

Several indicator messages are used by the projector to alert users of problems with setup or internal parts. The LEDs on the top surface of the projector show the status of the power, lamps 1 and 2 as well as the general working order of the projector through the status LED (see OSD Controls and Status LEDs on page 8 for location). The following tables describe the various states of the 4 LEDs.

#### *The Power LED*

PROJECTOR STATUS	LED CONDITION	LED SEQUENCE	PROJECTOR CONDITION
AC off	Off	Off	Off
Cooling	Orange blink	0.5 secs on 0.5 secs off	After power off
Power up sequence	Green blink	0.5 secs on 0.5 secs off	Start up
Standby	Orange on	On	Standby
Power on	Green on	On	On

#### *The Status LED*

PROJECTOR STATUS	LED CONDITION	LED SEQUENCE	PROJECTOR CONDITION
Normal condition	Off	Off	Power on
Cover ERROR	Red 1 time blink (repeatedly)	0.5 secs on 2.5 secs off	ERROR
Temperature ERROR	Red 2 times blink (repeatedly)	(0.5 secs ON > 0.5 secs OFF) * 2 > 2.0 secs OFF	ERROR
Fan ERROR	Red 4 times blink (repeatedly)	(0.5 secs ON > 0.5 secs OFF) * 4 > 2.0 secs OFF	ERROR
Keylocked (when push key)	Orange light up	On	Keylocked function enabled
Standby (Power-saving)	Off	Off	Standby (Power-saving)
Standby (Normal)	Green light	On	Standby (Normal)

*The Lamp LEDs*

<b>PROJECTOR STATUS</b>	<b>LED CONDITION</b>	<b>LED SEQUENCE</b>	<b>PROJECTOR CONDITION</b>
Lamp off	Off	Off	Lamp off
End of the lamp life	Red blink	0.5 secs on 0.5 secs off	Replace lamp (see notes below)
No lamp	Red 1 time blink (repeatedly)	0.5 secs on 2.5 secs off	ERROR
Lamp ERROR	Red 6 times blink (repeatedly)	(0.5 secs ON > 0.5 secs OFF) * 6 > 2.0 secs OFF	ERROR
Cooling lamp	Orange blink	0.5 secs ON > 0.5 secs OFF	Switching lamp 1 and 2
Re-light up sequence	Green blink	0.5 secs ON > 0.5 secs OFF	Start up
Lamp life over (cannot lamp on)	Red on	On	Replace lamp (see notes below)
Eco mode	Orange on	On	Power on
Normal mode	Green on	On	Power on

## 7. Appendix

---

### Common Problems and Solutions

These guidelines provide tips to deal with problems you may encounter while using the projector. If the problem remains unsolved, contact your dealer for assistance.

Often the problem is something as simple as a loose connection. Check the following before proceeding to the problem-specific solutions.

- Use some other electrical device to confirm that the electrical outlet is working.
- Ensure the projector is turned on.
- Ensure all connections are securely attached.
- Ensure the attached device is turned on.
- Ensure a connected PC is not in suspend mode.
- Ensure a connected notebook computer is configured for an external display. (This is usually done by pressing an Fn-key combination on the notebook.)

### Tips for Troubleshooting

In each problem-specific section, try the steps in the order suggested. This may help you to solve the problem more quickly.

Try to pinpoint the problem to avoid replacing non-defective parts.

For example, if you replace batteries and the problem remains, put the original batteries back and go to the next step.

Keep a record of the steps you take when troubleshooting: The information may be useful when calling for technical support or for passing on to service personnel.

### ③ Image Problems

***Problem: No image appears on the screen***

1. Verify the settings on your notebook or desktop PC.
2. Turn off all equipment and power up again in the correct order.

***Problem: The image is blurred***

1. Adjust the **Focus** on the projector.
2. Press the **Auto Adjust** button on the remote control or projector.
3. Ensure the projector-to-screen distance is within the specified range.
4. Check that the projector lens is clean.
5. Remove the lens cover.

***Problem: The image is wider at the top or bottom (trapezoid effect)***

1. Position the projector so it is as perpendicular to the screen as possible.
2. Use the Keystone button on the remote control or projector to correct the problem.

***Problem: The image is reversed or upside down***

Check the **Orientation** setting on the **Setup** menu of the OSD.

***Problem: The image is streaked***

1. Set the **Clock** and **Phase** settings on the **Adjust** menu of the OSD to the default settings.
2. To ensure the problem is not caused by a connected PC's video card, connect to another computer.

***Problem: The image is flat with no contrast***

1. Adjust the **Contrast** setting on the **Adjust** menu of the OSD.
2. Adjust the Brightness setting on the **Adjust** menu of the OSD.

***Problem: The color of the projected image does not match the source image.***

Adjust the Color **Temperature** and **Gamma Correction** settings on the **Detail Settings** menu of the OSD.

#### Lamp Problems

***Problem: There is no light from the projector***

1. Check that the power cable is securely connected.
2. Ensure the power source is good by testing with another electrical device.
3. Restart the projector in the correct order and check that the Power LED is green.

## 7. Appendix

---

4. If you have replaced the lamp recently, try resetting the lamp connections.
5. Replace the lamp module.
6. Remove the lens cover.
7. Put the old lamp back in the projector and have the projector serviced.

### ***Problem: The lamp goes off***

1. Power surges can cause the lamp to turn off. Press the power button twice to turn off the projector. When the Power LED is orange, press the power button.
2. Replace the lamp module.
3. Put the old lamp back in the projector and have the projector serviced.

### *Remote Control Problems*

#### ***Problem: The projector does not respond to the remote control***

1. Direct the remote control towards remote sensor on the projector.
2. Ensure the path between remote and sensor is not obstructed.
3. Turn off any fluorescent lights in the room.
4. Check the battery polarity.
5. Replace the batteries.
6. Turn off other Infrared-enabled devices in the vicinity.
7. Have the remote control serviced.

### *Audio Problems*

#### ***Problem: There is no sound***

1. Adjust the volume on the remote control.
2. Adjust the volume of the audio source.
3. Check the audio cable connection.
4. Test the source audio output with other speakers.
5. Have the projector serviced.

#### ***Problem: The sound is distorted***

1. Check the audio cable connection.
2. Test the source audio output with other speakers.
3. Have the projector serviced.

## **④ Having the Projector Serviced**

If you are unable to solve the problem, you should have the projector serviced. Pack the projector in the original carton. Include a description of the problem and a checklist of the steps you took when trying to fix the problem. The information may be useful to the service personnel. Return the projector to the place you purchased it.

## 8. Specifications

### 1 Projector Specifications

This section provides technical information about the projector's performance.

#### *Optical Specifications*

ITEM	DESCRIPTION
Projection system	Single DLP™ chip, 4 segment color wheel
Resolution	1024 x 768 pixels* (up to UXGA @ 60 Hz, up to SXGA+ @ 60 Hz on DVI-D)
Lamp	260 W AC (230 W in Eco mode), Dual lamp system
Light Output	5200 lumens** on NP08ZL, Dual lamp (approx. 85% in Eco mode)
Contrast Ratio (full white: full black)	1000:1, 2100:1 with DynamicBlack
Image Size (diagonal)	50" - 200" / 1.27m - 5.08m (NP06FL) 40" - 500" / 1.02m - 12.7m (NP07ZL, NP08ZL, NP09ZL, NP10ZL)
Lens Options	NP06FL: Power focus, throw ratio 0.77:1, F2.0, f=11.4 mm NP07ZL: Power zoom and focus, throw ratio 1.33-1.79:1, F1.8-2.3, f=19.3-25.8 mm NP08ZL: Power zoom and focus, throw ratio 1.78-2.35:1, F1.7-1.9, f=26-34 mm NP09ZL: Power zoom and focus, throw ratio 2.22-4.43:1, F2.1-2.9, f=32-63 mm NP10ZL: Power zoom and focus, throw ratio 4.43-8.3:1, F2.2-3.1, f=63.5-117.4 mm
Lens Shift	Vertical + 0.5V, Horizontal +/- 0.1H (NP07ZL, NP08ZL, NP09ZL, NP10ZL)

\*Effective pixels are more than 99.99%

\*\*This is the light output value (lumens) when the [Preset] mode is set to [High-Bright]. If any other mode is selected as the [Preset] mode, the light output value may drop slightly.

*Electrical Specifications*

ITEM	DESCRIPTION
Inputs	1 Analog RGB (Mini D-Sub 15P), 1 Analog RGB R/Cr, G/Y, B/Cb, H, V (BNC x 5), 1 Digital RGB (DVI-D 24P), 1 Component Y, Cb/Pb, Cr/Pr (RCA x 3), 1 Component (Mini D-Sub 15P) shared with COMPUTER 1 IN, 1 S-Video (Mini DIN 4P), 1 Video, 3 Stereo Mini Audio, 2 (L/R) RCA Audio, 1 Remote Control (Stereo Mini)
Outputs	1 RGB (Mini D-Sub 15P), 1 Stereo Mini Audio, 1 Screen Trigger
Control	1 PC Control Port (D-Sub 9P), 1 GPIO (Mini D-sub 15P)
USB Port	1 B Type (for Service)
LAN Port	RJ-45
Video Compatibility	NTSC, NTSC4.43, PAL, PAL-60/N/M/B/G/H/I, SECAM, HDTV: 1080i, 720p, SDTV: 576p, 576i, 480p, 480i
Scan Rate	Horizontal: 15 kHz, 31 to 90 kHz (RGB: 31 kHz or over) Vertical: 50 Hz to 85 Hz
Video Bandwidth	RGB: 100 MHz (-3dB)
Color Reproduction	16.7 million colors simultaneously, Full color
Horizontal Resolution	NTSC / NTSC4.43 / PAL / PAL-M / PAL-N / PAL60: 540 TV lines SECAM: 300 TV lines RGB: 1024 dots (H) x 768 dots (V)
External Control	RS232, IR, LAN, GPIO
Sync Compatibility	Separate Sync / Composite Sync / Sync on G
Built-in Speakers	3W x 2
Power Requirement	100 - 240V AC, 50/60Hz
Input Current	6.5A

## 8. Specifications

---

ITEM	DESCRIPTION
Power Consumption	655W in Dual Lamp Normal mode / 580W in Dual Lamp Eco mode 350W in Single Lamp Normal mode / 315W in Single Lamp Eco mode < 30W in Standby mode Normal < 5W in Standby mode Power saving

### Mechanical Specifications

ITEM	DESCRIPTION
Installation	Orientation: Desktop/Front, Desktop/Rear, Ceiling/Front, Ceiling/Rear
Dimensions	19.9" (W) x 7.8" (H) x 15.2" (D) 505 mm (W) x 197 mm (H) x 385 mm (D) (not including protrusions)
Weight	36.4 lbs/16.5 kg

### Environmental Considerations

ITEM	DESCRIPTION
Operational Temperatures	41° to 104°F / 5° to 40°C, 20% to 80% humidity (non-condensing)
Storage Temperatures	14° to 122°F (-10° to 50°C), 20% to 80% humidity (non-condensing)

### Regulations

UL/C-UL Approved (UL 60950-1, CSA 60950-1)

Meets FCC Class B requirements

Meets DOC Canada Class B requirements

Meets AS/NZS CISPR.22 Class B

Meets EMC Directive (EN55022, EN55024, EN61000-3-2, EN61000-3-3)

Meets Low Voltage Directive (EN60950-1, TÜV GS Approved)

For additional information visit:

US : <http://www.necdisplay.com>

Europe : <http://www.nec-display-solutions.com>

Global : <http://www.nec-pj.com/>

For information on our optional accessories, visit our website or see our brochure.

The specifications are subject to change without notice.

## 8. Specifications

---

### ② Cabinet Dimensions

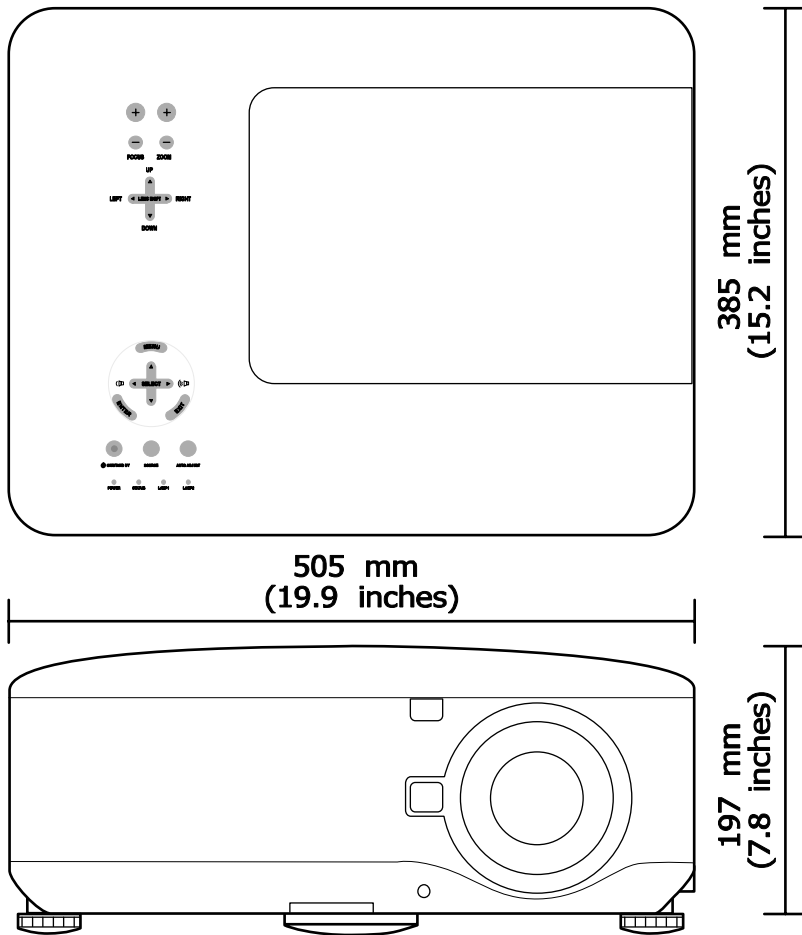

**③ Pin Assignments of Mini D-Sub 15 Pin Input Connector**

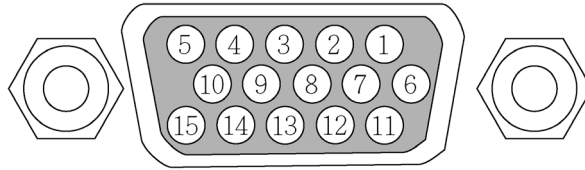

Signal Levels

Video signal: 0.7Vp-p (Analog)

Sync signal: TTL level

<b>PIN NUMBER</b>	<b>RGB SIGNAL (ANALOG)</b>	<b>YCbCr SIGNAL</b>
<b>1.</b>	Red	Cr
<b>2.</b>	Green or Sync on Green	Y
<b>3.</b>	Blue	Cb
<b>4.</b>	Ground	
<b>5.</b>	Ground	
<b>6.</b>	Red Ground	Cr Ground
<b>7.</b>	Green Ground	Y Ground
<b>8.</b>	Blue Ground	Cb Ground
<b>9.</b>	No Connection	
<b>10.</b>	Sync Signal Ground	
<b>11.</b>	No Connection	
<b>12.</b>	Bi-directional DATA (SDA)	
<b>13.</b>	Horizontal Sync or Composite Sync	
<b>14.</b>	Vertical Sync	
<b>15.</b>	Data Clock	

## 8. Specifications

### ④ Compatible Input Signal List

The following table shows compatible signal types, their resolution and frequency refresh rates.

Horizontal: 15 kHz, 31kHz to 90 kHz

Vertical: 50 Hz to 85 Hz

SIGNAL		RESOLUTION (DPI)	FREQUENCY REFRESH RATE (KHZ)	FREQUENCY REFRESH RATE (HZ)
NTSC	–	–	15.73	60.00
PAL	–	–	15.63	50.00
PAL60	–	–	15.73	60.00
SECAM	–	–	15.63	50.00
VESA	D	640 x 480	31.47	59.94
MAC	D	640 x 480	35.00	66.67
VESA	D	640 x 480	37.86	72.81
VESA	D	640 x 480	37.50	75.00
VESA	D	640 x 480	43.27	85.01
VESA	D	800 x 600	35.16	56.25
VESA	D	800 x 600	37.88	60.32
VESA	D	800 x 600	48.08	72.19
VESA	D	800 x 600	46.88	75.00
VESA	D	800 x 600	53.67	85.06
MAC	D	832 x 624	49.72	74.55
VESA	D	1024 x 768	48.36	60.00
VESA	D	1024 x 768	56.48	70.07
MAC	D	1024 x 768	60.24	74.93
VESA	D	1024 x 768	60.02	75.03
VESA	D	1024 x 768	68.68	85.00
VESA	D	1152 x 864	67.50	75.00

## 8. Specifications

SIGNAL		RESOLUTION (DPI)	FREQUENCY REFRESH RATE (KHz)	FREQUENCY REFRESH RATE (Hz)
VESA	D	1280 x 960	60.00	60.00
VESA	D	1280 x 1024	63.98	60.02
VESA	D	1400 x 1050	65.30	60.00
HDTV (1080i)(1125i)	–	1920 x 1080	33.75	60.00 Interlace
HDTV (1080i)(1125i)	–	1920 x 1080	28.13	50.00 Interlace
HDTV (720p)(750p)	–	1280 x 720	45.00	60.00 Progressive
HDTV (720p)	–	1280 x 720	37.50	50.00 Progressive
SDTV(576p)(625p)	–	–	31.25	50.00 Progressive
SDTV (480p)(525p)	–	–	31.47	59.94 Progressive
DVD YCbCr	–	–	15.73	59.94 Interlaced
DVD YCbCr	–	–	15.63	50.00 Interlaced

**Note:**

*Images above flagged with "D" are supported by digital signal.*

*An image with higher or lower resolution than the projector's native resolution (1024 x 768) will be compressed.*

*Some Composite and Sync on Green signals may not be displayed correctly.*

*Signals other than those specified in the table above may not be displayed correctly. If this should happen, change the refresh rate or resolution on your PC. Refer to Display Properties help section of your PC for procedures.*

## 8. Specifications

### ⑤ PC Control Codes and Cable Connections

The following table shows PC functions and their associated code data.

FUNCTION	CODE DATA
POWER ON	02H 00H 00H 00H 02H
POWER OFF	02H 01H 00H 00H 03H
INPUT SELECT COMPUTER 1	02H 03H 00H 00H 02H 01H 01H 09H
INPUT SELECT COMPUTER 2	02H 03H 00H 00H 02H 01H 02H 0AH
INPUT SELECT COMPUTER 3	02H 03H 00H 00H 02H 01H 1AH 22H
INPUT SELECT COMPONENT	02H 03H 00H 00H 02H 01H 10H 18H
INPUT SELECT VIDEO	02H 03H 00H 00H 02H 01H 06H 0EH
INPUT SELECT S-VIDEO	02H 03H 00H 00H 02H 01H 0BH 13H
PICTURE MUTE ON	02H 10H 00H 00H 00H 12H
PICTURE MUTE OFF	02H 11H 00H 00H 00H 13H
SOUND MUTE ON	02H 12H 00H 00H 00H 14H
SOUND MUTE OFF	02H 13H 00H 00H 00H 15H
ON-SCREEN MUTE ON	02H 14H 00H 00H 00H 16H
ON-SCREEN MUTE OFF	02H 15H 00H 00H 00H 17H
ASPECT RATIO	
4:3	03H 10H 00H 00H 05H 18H 00H 00H 00H 30H
16:9	03H 10H 00H 00H 05H 18H 00H 00H 02H 00H 32H
Crop	03H 10H 00H 00H 05H 18H 00H 00H 03H 00H 33H
AUTO ADJUST	02H 0FH 00H 00H 02H 05H 00H 18H

**Note:**

Contact your local dealer for a full list of the PC Control Codes if needed.

#### Communication Protocol

Baud rate ..... 38400 bps  
 Data length ..... 8 bits  
 Parity ..... No parity  
 Stop bit ..... One bit  
 X on/off ..... None  
 Communications procedure ..... Full duplex

**Note:**

Depending on the equipment, a lower baud rate may be recommended for long cable runs.

### PC Control Connector (DIN-9P)

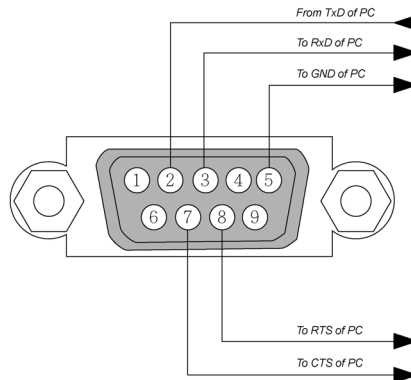

**Note:**

1. Pin 1, 4, 6 and 9 are not used.
2. Jumper "Request to Send" and "Clear to Send" together on both ends of the cable to simplify the cable connection.
3. For long cables, it is recommended to set communication speed within projector menus to 9600 bps.

## 8. Specifications

---

### ⑥ Screen Trigger

When the projector is powered ON the screen trigger output sends a low voltage trigger to the screen controller and the screen will go down. When the projector is powered OFF the screen trigger stops sending a low voltage trigger to the screen controller and the screen will go up.

**Note:**

To use this feature, you must turn on the Screen Trigger function. See Screen Trigger on page 87 for more information.

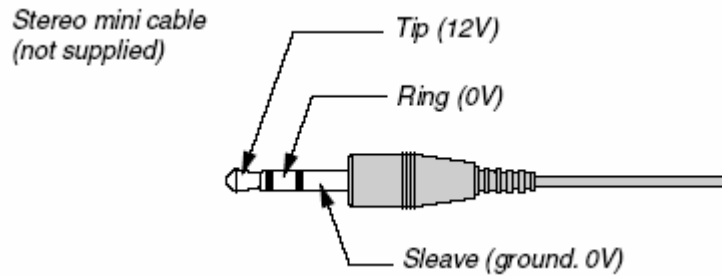

**Note:**

Screen controllers are supplied and supported by screen manufacturers.

**Note:**

Do not use this jack for anything other than intended use. Connecting the wired remote control to the SC. TRIGGER Mini Jack causes damage to the remote control.

### ⑦ Operation Using HTTP Browser

#### *Overview*

The use of HTTP server functions will allow control of the projector from a web browser without the installation of special software. Please be sure to use “Microsoft Internet Explorer 4.x” or a higher version for the web browser. (This device uses “JavaScript” and “Cookies” and the browser should be set to accept these functions. The setting method will vary depending on the version of browser. Please refer to the help files and the other information provided in your software).

Access is gained to the HTTP server functions by specifying the following address in the entry column of the URL:

**http:// <the projector's IP address> /index.html**

**http:// <the projector's IP address> /lanconf.html**

#### **Note:**

*The display or button responses can be slowed down or operation may not be accepted depending the settings of your network. Should this happen, consult your network administrator. The projector may not respond if its buttons are repeatedly pressed in rapid intervals. Should this happen, wait a moment and repeat. If you still can't get any response, turn off and back on the projector.*

#### *Preparation Before Use*

Make network connections, set up the projector and confirm that it is complete before engaging in browser operations (see LAN Settings on page 84 for more information).

Operation with a browser that uses a proxy server may not be possible depending on the type of proxy server and the setting method. Although the type of proxy server will be a factor, it is possible that items that have actually been set will not be displayed depending on the effectiveness of the cache, and the contents set from the browser may not be reflected in operation. It is recommended that a proxy server not be used unless it is unavoidable.

#### *Handling of the Address for Operation via a Browser*

Regarding the actual address that is entered for the address or entered to the URL column when operation of the projector is via a browser, the host name can be used as it is when the host name corresponding to the IP address of the projector has been registered to the domain name server by a network administrator, or the host name corresponding to the IP address of the projector has been set in the “HOSTS” file of the computer being used.

#### **Example 1:**

When the host name of the projector has been set to **pj.nec.co.jp**,

**http://pj.nec.co.jp/index.html** is specified for the address or the entry column of the URL.

#### **Example 2:**

## 8. Specifications

When the IP address of the projector is **192.168.73.1**, access is gained to the HTTP server functions by specifying **http://192.168.73.1/index.html** for the address or the entry column of the URL.

### Configuring Network Settings

The Network Settings screen is displayed as follows:

**http:// <the projector's IP address> /lanconf.html**

The screenshot shows a web-based configuration interface for a projector. The title bar reads "Projector". The interface is divided into four main sections, each with a header and a "Apply" button:

- Domain:** Contains two text input fields labeled "Host Name" and "Domain Name".
- Mail:** Features a "Alert Mail" section with radio buttons for "Enable" and "Disable". Below are four text input fields labeled "Sender's Address", "SMTP Server Name", "Recipient's Address 1", "Recipient's Address 2", and "Recipient's Address 3".
- Test Mail:** Includes an "Execute" button and a "Test Mail Status" field with a scrollable area below it.
- PJLink:** Has a "PJLink" section with radio buttons for "On" and "Off", and a "Password" text input field.

#### *Domain*

**Host Name:** Type in a hostname. Up to 60 alphanumeric characters can be used.

**Domain Name:** Type in domain name of the network connected to the projector. Up to 60 alphanumeric characters can be used.

**Apply:** Click to reflect the entries.

### Mail

**Alert Mail:** Click “Enable” to enable Alert Mail feature. This option notifies your computer of an error message via e-mail when using wired LAN. The error message will be notified when the projector lamp has reached the end of its usable life or an error occurs in the projector.

**Sender's Address:** Specify the sender's address. Up to 60 alphanumeric and symbols characters can be used.

**SMTP Server Name:** Type in the SMTP server name to be connected to the projector. Up to 60 alphanumeric characters can be used.

**Recipient's Address 1 to 3:** Type in your recipient's address. Up to 60 alphanumeric and symbols characters can be used.

**Apply:** Click to apply the settings.

### Test Mail

Send a test mail to check if your settings are correct. Click to “Execute” to enable this feature.

**Test Mail Status Button:** Click to display the test result.

Sample of a message sent from the projector:

Projector Name: X X X X

Lamp 1 or 2 Hours Used: xxxx [H]

The lamp is at the end of its usable life. Please replace the lamp.

**Note:**

*If you entered an incorrect address in a test, you may not receive an Alert mail. Should this happen, check if the Recipient's Address is correctly set.*

*Unless any one of the [Sender's Address], [SMTP Server's Name] or [Recipient's Address 1-3] is selected, [Test Mail] is not available.*

### PJLink

This option allows you to set a password when you use the PJLink feature.

**On/Off:** Enable or disable the password.

**Password:** Enter a password (up to 32 characters)

**Note:**

*PJLink is a standardization of protocol used for controlling projectors of different manufacturers. This standard protocol is established by Japan Business Machine and Information System Industries Association (JBMA) in 2005. The projector supports all the commands of PJLink Class 1.*

## 8. Specifications

### *Structure of the HTTP Server*

Once the projector is connected to a network and configured correctly, the following screen is displayed through the web browser.

**http:// <the projector's IP address> /index.html**

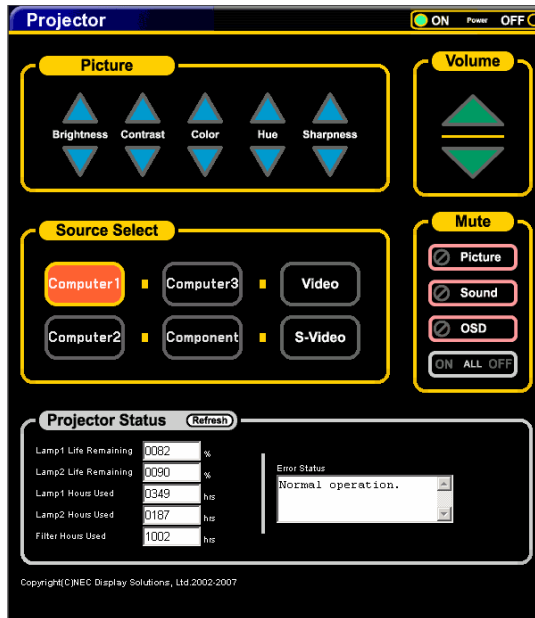

FUNCTION	SETTING	DESCRIPTION
Power Panel	On Off	This controls the power to the projector
Volume Panel	▲ – Increases the volume adjustment value ▼ – Decreases the volume adjustment value	This controls the volume of the projector
Mute Panel	Picture On – Mutes the video Picture Off – Cancels the video muting Sound On – Mutes the audio Sound Off – Cancels the audio muting OSD On – Mutes the on-screen display OSD Off – Cancels the muting of the on-screen display All On – Mutes each of the video, audio, and on-screen display functions All Off – Cancels the muting of each of the video, audio, and on-screen display functions	This controls the mute functions of the projector
Picture Panel	Brightness ▲▼ – Increases or decreases the brightness adjustment value Contrast ▲▼ – Increases or decreases the contrast adjustment value Color ▲▼ – Increases or decreases the color adjustment value Hue ▲▼ – Increases or decreases the hue adjustment value Sharpness ▲▼ – Increases or decreases the sharpness adjustment value	Controls the video adjustments of the projector

## 8. Specifications

FUNCTION	SETTING	DESCRIPTION
Source Select Panel	Computer1 – Switches to the COMPUTER 1 IN connector  Computer2 – Switches to the COMPUTER 2 IN connector  Computer3 – Switches to the COMPUTER 3 IN connector  Component – Switches to the COMPONENT IN connectors  Video – Switches to the VIDEO IN connector  S-Video – Switches to the S-VIDEO IN connector	This switches the input connector of the projector
Projector Status Panel	Refresh – Updates the panel with the latest information available  Lamp 1 Life Remaining – Displays the remaining life of Lamp1 as a percentage  Lamp 1 Hours Used – Displays the number of hours Lamp1 has been used  Lamp 2 Life Remaining – Displays the remaining life of Lamp2 as a percentage  Lamp 2 Hours Used – Displays the number of hours Lamp2 has been used  Filter Hours Used – Displays the number of hours Filter has been used.  Error Status – Displays the status of errors occurring within the projector	This displays the status of selected projector functions

**Note:**

*The functions that can be controlled will vary depending on the signal being input to the projector (see [Selecting a Source](#) on page 36 for more information).*

## 8. Specifications

### ⑧ 15 Pin GPIO Control

Type: 15Pin D-SUB black female type

PIN No.	SHORT/OPEN				FUNCTION
14	SHORT OPEN				EXTERNAL CONTROL MODE ON EXTERNAL CONTROL MODE OFF
5	SHORT OPEN				POWER ON POWER OFF
10	SHORT OPEN				PICTURE MUTE ON PICTURE MUTE OFF
3	SHORT OPEN				SOUND MUTE ON SOUND MUTE OFF
4, 8, 12, 11	11	12	8	4	
	OPEN	OPEN	OPEN	OPEN	COMPUTER1
	OPEN	OPEN	OPEN	SHORT	VIDEO1
	OPEN	OPEN	SHORT	OPEN	S-VIDEO1
	OPEN	OPEN	SHORT	SHORT	COMPONENT
	OPEN	SHORT	OPEN	OPEN	NOT AVAILABLE
	OPEN	SHORT	OPEN	SHORT	COMPUTER2
	OPEN	SHORT	SHORT	OPEN	NOT AVAILABLE
	OPEN	SHORT	SHORT	SHORT	NOT AVAILABLE
	SHORT	OPEN	OPEN	OPEN	COMPUTER3 (DVI)
	SHORT	OPEN	OPEN	SHORT	NOT AVAILABLE
	SHORT	OPEN	SHORT	OPEN	NOT AVAILABLE
	SHORT	OPEN	SHORT	SHORT	NOT AVAILABLE
	SHORT	SHORT	OPEN	OPEN	NOT AVAILABLE
	SHORT	SHORT	OPEN	SHORT	NOT AVAILABLE
	SHORT	SHORT	SHORT	OPEN	NOT AVAILABLE
	SHORT	SHORT	SHORT	SHORT	NOT AVAILABLE

# 9. Troubleshooting Check List

Before contacting your dealer or service personnel, check the following list to be sure repairs are needed also by referring to the  Troubleshooting section on page 104 of your user's manual. This checklist below will help us solve your problem more efficiently.

**Frequency of Occurrence** always sometimes (How often? \_\_\_\_\_) other (\_\_\_\_\_)

## Power

- No power (POWER indicator does not light green) See also "Status Indicator (STATUS)".
  - Power cable's plug is fully inserted into the wall outlet.
  - Main power switch is pressed to the ON position.
  - Lamp cover is installed correctly.
  - Lamp Hours Used (lamp operation hours) was cleared after lamp replacement.
  - No power even though you press and hold the POWER button for a minimum of 2 seconds.**
- Shut down during operation.
  - Power cable's plug is fully inserted into the wall outlet.
  - Lamp cover is installed correctly.
  - Power Management is turned off (only models with the Power Management function).
  - Off Timer is turned off (only models with the Off Timer function).

## Video and Audio

- No image is displayed from your PC or video equipment to the projector.
  - Still no image even though you connect the projector to the PC first, then start the PC.
  - Enabling your notebook PC's signal output to the projector.
    - A combination of function keys will enable/disable the external display. Usually, the combination of the "Fn" key along with one of the 12 function keys turns the external display on or off.
  - No image (blue background, logo, no display).
  - Still no image even though you press the AUTO ADJUST button.
  - Still no image even though you carry out [Reset] in the projector's menu.
  - Signal cable's plug is fully inserted into the input connector
  - A message appears on the screen.  
( \_\_\_\_\_ )
  - The source connected to the projector is active and available.
  - Still no image even though you adjust the brightness and/or the contrast.
  - Input source's resolution and frequency are supported by the projector.
- Image is too dark.
  - Remains unchanged even though you adjust the brightness and/or the contrast.
- Image is distorted.
  - Image appears to be trapezoidal (unchanged even though you carry out the [Keystone] or [3D Reform] adjustment).
- Parts of the image are lost.
  - Still unchanged even though you press the AUTO ADJUST button.
  - Still unchanged even though you carry out [Reset] in the projector's menu.
- Image is shifted in the vertical or horizontal direction.
  - Horizontal and vertical positions are correctly adjusted on a computer signal.
  - Input source's resolution and frequency are supported by the projector.
  - Some pixels are lost.
- Image is flickering.
  - Still unchanged even though you press the AUTO ADJUST button.
  - Still unchanged even though you carry out [Reset] in the projector's menu.
  - Image shows flickering or color drift on a computer signal.
- Image appears blurry or out of focus.
  - Still unchanged even though you checked the signal's resolution on PC and changed it to projector's native resolution.
  - Still unchanged even though you adjusted the focus.
- No sound.
  - Audio cable is correctly connected to the audio input of the projector.
  - Still unchanged even though you adjusted the volume level.
  - AUDIO OUT is connected to your audio equipment (only models with the AUDIO OUT connector).



## 9. Troubleshooting Check List

### Signal cable

NEC standard or other manufacturer's cable?

Model number:                      Length:                      inch/m

Distribution amplifier

Model number:

Switcher

Model number:

Adapter

Model number:

### Computer

Manufacturer:

Model number:

Notebook PC  / Desktop

Native resolution:

Refresh rate:

Video adapter:

Other:

### Video equipment

VCR, DVD player, Video camera, Video game or other

Manufacturer:

Model number:

