



TouchStream[®]

User's Guide



connecting content to opportunity

www.digital-rapids.com

© 2010 Digital Rapids Corporation. All rights reserved.

Digital Rapids, the Digital Rapids logo, and TouchStream are trademarks or registered trademarks of Digital Rapids Corporation.

Except as permitted by such license, no part of this document may be reproduced, transmitted, or converted in any form or by any means electronic or mechanical for any purpose, without the prior written permission of Digital Rapids Corporation.

Information in this manual is furnished for information only and does not represent a commitment on the part of Digital Rapids Corporation. Information in this manual is subject to change without notice. Digital Rapids Corporation assumes no responsibility or liability for any errors or inaccuracies that may appear in this manual.

Digital Rapids Corporation makes no warranties, express or implied, including without limitation the implied warranties of merchantability and fitness for a particular purpose, regarding the software. Digital Rapids Corporation does not warrant, guarantee or make any representations regarding the use or the results of the use of the software in terms of its correctness, accuracy, reliability, currentness or otherwise. The entire risk as to the results and performance of the software is assumed by you. The exclusion of implied warranties is not permitted by some jurisdictions. The above exclusion may not apply to you.

In no event will Digital Rapids Corporation be liable to you for any consequential, incidental or indirect damages (including damages for loss of business profits, business interruption, loss of business information, and the like) arising out of the use or inability to use the software even if Digital Rapids Corporation had been advised of the possibility of such damages. Because some jurisdictions do not allow the exclusion or limitation of liability for consequential or incidental damages, the above limitations may not apply to you. Digital Rapids Corporation's liability to you for actual damages from any cause whatsoever, and regardless of the form of the action (whether in contract, tort (including negligence), product liability or otherwise), will be limited to \$50.

For information on the Warranty for the Digital Rapids hardware, please see the Warranty section at the end of the user's guide.

Last revised on August 17, 2010.

Table of Contents

Safety Instructions	1
CAUTION.....	1
Use Only for Intended Applications	1
Checking the Power Cord.....	2
Warnings and Cautions	2
TouchStream Connections	4
Connecting Video and Audio Inputs.....	4
Connecting to the Network.....	5
Connecting an External Hard Drive.....	6
Connecting a Monitor, Keyboard, Mouse.....	6
TouchStream Software Operation	7
Overview	7
Getting Started – Using a previous configuration.....	7
Getting Started – Setting up a new configuration.....	8
Setup	10
Trigger	10
Pause/Resume	11
Project.....	12
Input.....	13
Output	13
Video Settings and Audio Settings	17
Video Settings	18
Graphic Overlay.....	18
Picture Controls	19
Noise Reduction	19
Cropping	21

Audio Settings	21
Levels.....	21
Bass/Treble	21
Audio Pass-Through for Monitoring	22
Info.....	22
Email Config.....	23
Network Settings.....	23
Reset.....	24
Security: Lock	24
Security: Restrictions	24
Customizing TouchStream Projects.....	26
GPI - General Purpose Interface	28
TouchStream System Specifications	29
DRC-Stream PCI Card Specifications	30
DRC-500.....	30
DRC-1600.....	31
DRC- 5650.....	32
Regulatory Certifications and Compliance	34
WARNING: English (USA).....	37
AVERTISSEMENT: Français	39
Warranty.....	41
Limited Warranty for Digital Rapids TouchStream	41
Extent of Limited Warranty	41
Warranty Limitations and Exclusions.....	42
Limitations of Liability.....	42
Contact Information.....	43

Safety Instructions

Before you operate this product you will need to make sure you follow certain basic safety precautions.



CAUTION

Servicing of a chassis sub-assembly shall be performed only by technically qualified persons.

Follow these guidelines to meet and maintain safety and product regulatory requirements.

Read and adhere to all of these instructions and the instructions supplied with this assembly. If you do not follow these instructions, the UL listing and other regulatory approvals will be void, and the product will most likely be non-compliant with regional product laws and regulations.

Use Only for Intended Applications

WARNING: This is a Class A product. In a domestic environment this product may cause radio interference in which case the user may be required to take adequate measures.

This product was evaluated as Class A - Information Technology Equipment (ITE) that may be installed in offices, schools, computer rooms and similar locations. The suitability of this product for other Product Categories and Environments other than ITE applications, (such as medical, industrial, alarm systems, and test equipment) may require further evaluation.

When you operate this product observe all warnings and cautions in the User's Guide.

To avoid injury, be careful of:

- Sharp pins on connectors
- Sharp pins on printed circuit assemblies
- Rough edges and sharp corners on the chassis
- Hot components (like processors, voltage regulators, and heat sinks)
- Damage to wires that could cause a short circuit
- Pinched fingers when changing the angle of the front panel display
- Moving fan blades intended for cooling

Checking the Power Cord



WARNING

Do not attempt to modify or use the supplied AC power cord if it is not the exact type required.

The power supply cord is the main disconnect to AC power. The socket outlet must be installed near the equipment and be readily accessible.

If the power cord supplied with the system is not compatible with the AC wall outlet in your region, get one that meets the following criteria:

- The cord must be rated for the available AC voltage and have a current rating that is at least 125% of the current rating of the server.
- The plug on the power cord that plugs into the wall outlet must be a grounding-type male plug designed for use in your region. It must have certification marks showing certification by an agency acceptable in your region.
- The connector that plugs into the AC receptacle on the power supply must be an IEC 320, sheet C13, type female connector.
- In Europe, the cord must be less than 4.5 meters (14.76 feet) long, and it must be flexible <HAR> (harmonized) or VDE certified cordage to comply with the chassis' safety certifications.
- The user must comply with local electrical code requirements.



Warnings and Cautions

These warnings and cautions apply whenever you remove the chassis cover to access components inside the chassis. Only a technically qualified person should integrate and configure the unit.

WARNING / BEFORE YOU REMOVE THE ACCESS COVER

Before removing the access cover for any reason, observe these safety guidelines:

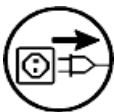

1. Turn off all peripheral devices connected to the unit.
2. Turn off the unit by pressing the power button on the front of the chassis. Then unplug the AC power cord from the chassis or wall outlet.
3. Label and disconnect all peripheral cables and all telecommunication lines connected to I/O connectors or ports on the back of the chassis.

4. Provide some electrostatic discharge (ESD) protection by wearing an antistatic wrist strap attached to building ground—any unpainted metal surface on a chassis that is still plugged in—when handling components.

WARNING

The power button on the front panel DOES NOT turn off the AC power.

To remove power from unit you must unplug the AC power cord from the wall outlet or the chassis.

WARNING

Hazardous electrical conditions may be present on power, telephone, and communication cables. Turn off the server and disconnect the power cord, telecommunications systems, networks, and any other peripheral devices attached to the unit before opening it. Otherwise, personal injury or equipment damage can result.

WARNING

Do not open the power supply. Hazardous voltage, current and energy levels are present inside the power supply. Refer servicing of the power supply to qualified technical service personnel.

WARNING

Danger of explosion or fire if the battery is incorrectly replaced. Replace only with the same or equivalent type recommended by the equipment manufacturer. Dispose of used batteries according to manufacturer's instructions.



The symbol of the crossed out wheeled bin indicates that the product (electrical and electronic equipment) should not be placed in municipal waste. Check local regulations for disposal of electronic products.

TouchStream Connections

Connecting Video and Audio Inputs

Your TouchStream unit will have one of three sets of connections available, depending on which model you purchased.



Option 1: Analog only

Video: One standard definition video channel selected from Composite (yellow) and S-video (black) inputs.

Audio: Two stereo audio channels selected from one Unbalanced stereo (white and red) and two Balanced stereo inputs (balanced input requires a small breakout cable be connected to the 15-pin connector).



Option 2: SDI standard definition

Video: One standard definition SDI video channel; connect the provided SDI connector (shown below) to the 62-pin connector.

Audio: Two stereo channels of embedded SDI audio

Optional with breakout cable or breakout box connected to the 62-pin connector: One analog video (Composite, S-video, Component), 4 stereo analog audio (Balanced, Unbalanced), two stereo AES digital audio inputs

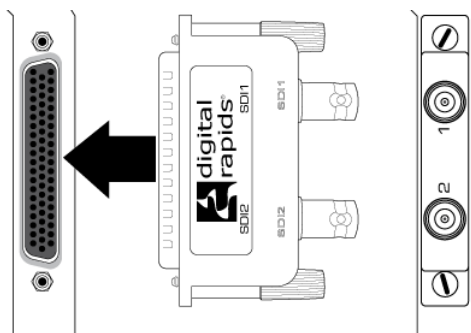



Option 3: SDI HD/SD input

Video: One video channel from HD/SD SDI input (second connector)

Audio: Four stereo channels of embedded SDI audio

Optional with breakout box: Four stereo channels of AES digital audio inputs

Note for HD inputs: HD inputs may require down-conversion (performed within TouchStream) to lower resolution or frame rate for streaming output (dependent on output format).

Connecting to the Network

The TouchStream unit includes a Gigabit Ethernet controller with a standard 8P8C (8 Position 8 Contact) connection, often referred to as an RJ45 connection.

Once you have physically connected the TouchStream unit to the network with a cable, you may have to configure the network settings using the TouchStream software. The software default is to automatically obtain an IP address and DNS if the network supports this capability. If the network does not support this you will need to ask your network administrator for the appropriate IP settings and you will have to enter them manually.

To get to the Network settings screen:

- From the main screen press the Info button
- On the Info screen press the Network Settings button

Both “Automatically obtain IP Address” and “Automatic DNS” will be enabled by default. Press the check mark box to disable them if you need to manually enter values provided by your network administrator.



Connecting an External Hard Drive

If you plan to create archive files with your TouchStream unit you must have either purchased the internal storage option for your TouchStream unit or you must connect an external drive to your unit. You cannot write archive files to the internal "C" drive of the TouchStream unit.

There are two USB 2.0 ports on the back of the unit and two Firewire ports that can be used to attach an external drive.

Maximum data transfer speeds: USB 480 Mbps; Firewire 400 Mbps

Connecting a Monitor, Keyboard, Mouse

Normal TouchStream operation only requires the touch screen front panel.

However, should you need to use something other than the TouchStream software on the box you may need to connect a monitor (DB15 connector), keyboard and mouse (PS/2 ports or USB) to the system. There are ports on the back of the unit for these devices.

To close the TouchStream software use the keyboard and click ALT-F4. **Do not change the screen resolution**, as the touch screen requires a specific resolution and it is not easy to reset once it has been changed.

TouchStream Software Operation

Overview

Getting Started – Using a previous configuration

If the TouchStream unit was previously configured, then the last settings that were used (e.g., Project, Source, etc.) will be loaded automatically. If you want to use the same settings as the last time then you can start streaming immediately.

If TouchStream was shut down in an “Armed” state, then when it is restarted the first button will be green.



If the TouchStream unit was shut down in an unarmed state, then simply press the Trigger button, choose your trigger type, press Arm, and you are ready to start streaming.

If TouchStream was shut down in an “unarmed” state, then when it is restarted the first button will be a Trigger button.



The Trigger button will be gray (or inactive) if the TouchStream has never been run or if the project that was previously loaded when the TouchStream software was shut down has been deleted. In that case you will need to set up the unit.

Getting Started – Setting up a new configuration

If you are setting up the TouchStream software for the first time, or you want to set up a new configuration, there are a few basic steps.

1. Press the Setup button.



The Setup screen will show the following buttons:



2. Press the Project Settings button. Choose the project that you want to use from the panel on the right. Information about the project will be displayed on the left. The default projects that are displayed in this list will vary, depending on the TouchStream model that you have purchased.
3. Press the Input Settings button and select the video and audio inputs that you want to use. The default input settings that are displayed in this list will vary, depending on the capture board installed in your TouchStream model.
4. Press the Output button and choose whether you want to enable an Archive output (to record to a file to an external drive) and/or to a Broadcast output. Note that if you want to create a live stream only, then you will need to disable the Archive output. For Flash projects, if you want to create a live stream only you will need to select a project does not include the Archive option.
5. Optional: You can adjust the Video Settings and Audio Settings if desired, checking the green Done button to return to the Setup screen each time.
6. Press the Trigger button to choose the method you plan to use to start and stop the encoding. Press the Arm button to accept the trigger setting and put the unit in a standby mode, or the Cancel button to return to the main Setup screen without setting a trigger.

7. If you pressed the Arm button on the Trigger screen you will be returned to the main interface and you will be able to start streaming based on your trigger.

If you later want to disarm the Trigger, you can press the Setup button to access the Trigger screen.

If you pressed the Cancel button on the Trigger screen you will be returned to the Setup screen and you can press the Done button to go the main screen.

8. On the main screen you will see a Fade In or a Fade Out button. If you set a Graphic Overlay during setup (on the Video Settings) you can use these buttons to control the graphic overlay.

9. The Video Settings and Audio Settings buttons on the main screen take you to the same settings screens as the Video Settings and Audio Settings buttons on the Setup screen. They have been included on the main screen for ease of access, as you can change the video and audio settings on the fly, while an encode is taking place, and the settings will be applied immediately to the encoded video and audio.

10. The Info button on the main screen provides you with information about your unit. If you are having an issue with your unit and you contact Digital Rapids Support for assistance they may direct you to use the Email option on this Info screen. This will email the unit's information directly to Digital Rapids Support.

The Info screen includes a Network Settings button to allow you to configure the TouchStream for network communications, with both automatic and manual configuration options. It also includes a Reset button (to restore the settings to their original state) and a Security button (to lock some or all of the functions). If you do not see some of the functions described in this manual, then the Lock or Restrictions function was used to restrict the available functions.

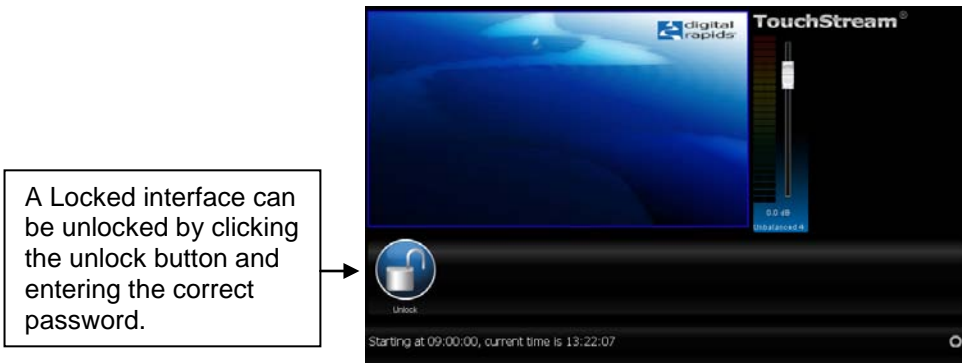

For details on all settings and operation, please see the following sections.

Setup

To access the Setup screen press the Setup button on the main interface.

Trigger

There are three trigger types available: Manual, GPI and Scheduled.

Note that Trigger settings are global settings that are overwritten when you click the Done button and return to the main screen. That is, the settings are not saved with the selected project, they are saved and applied to all projects on the TouchStream unit.

Manual Trigger

When you select Manual Trigger you will be starting the encode by pressing the Start button on the main interface.

You must select how you want stop the encode:

- **Manual Stop:** After you have pressed the Start button it will change to a red Stop button. Press this button to manually stop the encode.
- **Duration:** Specify how long you want to run the encode in hours:minute:seconds using the numeric keypad on the right hand side of the screen.
- **End Time:** Specify a time to end the encode in hours:minute:seconds using the numeric keypad on the right hand side of the screen. This time will be based on the system time. The current time will be displayed at the bottom of the screen. All times use a 24 hour clock.

Note that even if you selected a Duration or End Time you will be able to end the encode early by pressing the Stop button on the main screen after the encode has started.

GPI Trigger

TouchStream can monitor the serial communication port on the back of the unit for a GPI signal, and it can use that signal to start the encoding. For more information about making GPI cables please see [GPI - General Purpose Interface](#) on page 28.

You must also select how you want stop the encode:

- **GPI Stop:** the unit will monitor the serial communication port you specify and use the signal to stop the encoding.

- **Duration:** Specify how long you want to run the encode in hours:minute:seconds using the numeric keypad on the right hand side of the screen.
- **End Time:** Specify a time to end the encode in hours:minute:seconds using the numeric keypad on the right hand side of the screen. This time will be based on the system time. The current time is displayed at the bottom of the screen. All times use a 24 hour clock.

Scheduled Trigger

When you select Scheduled Trigger TouchStream can monitor the system clock to set a Start Time and a Stop Time for the encode.

Note that once the Scheduled Trigger has been armed you can override both the start and stop manually if desired by pressing the Start or Stop button on the main screen.

Arm, Disarm, Cancel

When you press the Arm button your selected trigger type will be active, and you will be returned to the main screen. If you press the Disarm button any previously selected trigger will be disabled. If you want to exit the trigger screen without changing any settings, press the Cancel button.

Pause/Resume

While the TouchStream unit is encoding the Pause button will be available.

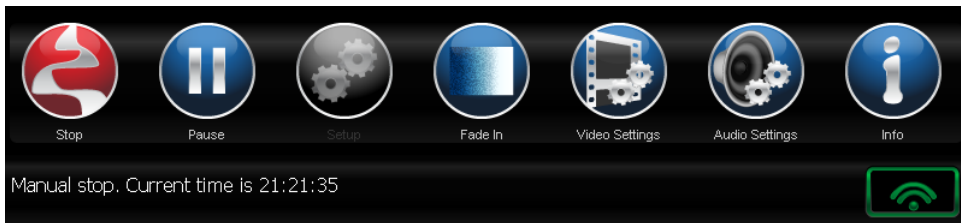

If you press the Pause button it will change to a Resume button.

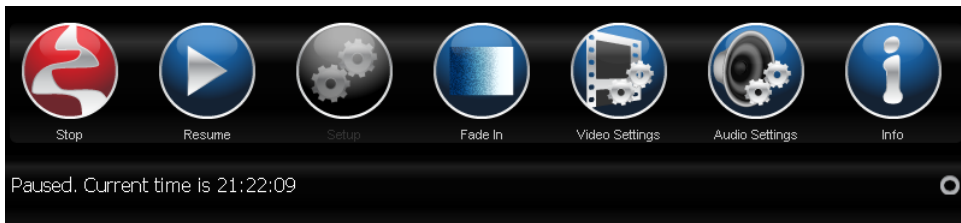

Project

The TouchStream unit comes with installed projects that use the most common settings for live streaming scenarios. When you press the Project Settings button you will be shown the projects that include codecs that you are licensed to run on your TouchStream model.

When you select a project the basic information about that project will be shown in the panel on the left side. If a project contains more than one encoder then you will see information for all of the individual encoders, each one in its own section as you scroll down.

TouchStream projects contain the following information:

- The encoder settings that are used to create the output, including such things as frame size, bitrate, audio information, frame rate, etc.
- Hardware deinterlacing setting (enabled by default on all projects)
- Output settings for archive and broadcast as appropriate
- For some codecs closed caption settings will be included in the project; these projects will include “CC_VBI” in the project name
- For some codecs transport stream muxer settings will be included in the project; these project names start with “TS_”

Installed TouchStream Projects

TouchStream has 4 basic models, with 3 input options. The projects that are available are the ones that can be used by your model and input option.

- TouchStream LE: Includes ASF, WM9 and Smooth Streaming projects
- TouchStream Web: Includes Flash (DRC AVC for Web) projects and ASF and WM9 projects
- If the Flash 8 option was purchased then On2 projects will be included
- TouchStream Mobile: Includes Dicas projects with 3 output streams per project: H263 at 176x144, MPEG4 at 240x180, H264 at 320x240
- TouchStream TS: Includes projects that output transport streams. The video in those transport streams will be either H264 or MPEG2. Also includes projects to output H264 using RTSP/RTP streaming.
- If the iPhone/iPad option was purchased then iPhone/iPad projects will be included. (You must have the optional internal drive or an external drive.)
- TouchStream with the SD SDI input option includes some additional projects that include NTSC closed captioning.

If you would like information on modifying projects please see [Customizing TouchStream Projects](#) on page 26.

Input

The TouchStream unit comes with installed input settings that use the most common settings for live streaming scenarios. When you press the Input Settings button you will be shown a list of all of the input settings that are installed on the unit that can be used by your TouchStream model.

When you select an input setting information about that input setting will be shown in the panel on the left side.

If you would like information about creating your own input settings please see [Customizing TouchStream Projects](#) on page 26.

Note that the selected input setting is not saved with the current project. The input setting is a global setting that will apply to all projects.

If you would like to use the DV output of a DV camera as an input for your TouchStream unit then please contact Digital Rapids support for an updated key. Use a firewire cable to connect the DV camera to TouchStream and turn on the DV camera. Go to the Input screen (or if you are currently on the Input screen, go to any other screen then go back to the Input screen to refresh the screen.) Your camera will be shown in the list of input setting options. Note that Video Settings and Audio Settings as well as hardware de-interlacing will not be available when you are using the DV output. If you need these settings then you can use one of the analog outputs commonly found on DV cameras to input video and audio to the TouchStream unit.

Output

TouchStream projects include outputs for Archive file creation and/or for live Broadcast streaming. Depending on the codecs included in the project you may have more than one type of Broadcast output option. By default all of the available output options for that project will be enabled. Disable the ones you do not plan to use by pressing the check mark next to the "Enable" to clear the box before you start encoding.



Archive File Output

You can use your TouchStream unit to create an archive file. If you plan to create archive files you must have purchased the internal storage option for your TouchStream unit or you must connect an external drive to your unit. You cannot write archive files to the internal "C" drive of the TouchStream unit. If you do not plan to create an archive file and do not have a suitable drive installed for writing archive files, then disable the archive output or your encode will not start.

Folder: To select the drive and folder for your archive files press the Browse button. All of the detected drives will be shown in the bottom half of the screen. Select the drive you want to use and any folders on that drive will be shown. Press the folder you want to use. Use the two buttons at the far right, a folder with a + symbol and a folder with a curved up arrow to add a new folder or to move up one level. If you add a new folder a keyboard panel will open to allow you to type a name for the new folder. Press the Done button after you have selected your folder. The full path will appear in the Folder field on the Output screen.

File: To select a file name for your archive file use the drop down arrow to pick an automatically generated file name based on the following:

- Start date, start time, profile name
(%PROJ.SDATE_%_%PROJ.STIME_%_%PN%)
- Start date, bit rate and auto incrementing number from 0
(%PROJ.SDATE_%_%BR%_%N.0%)
- Start date, start time and bit rate
(%PROJ.SDATE%_%PROJ.STIME_%_%BR%)

Note that the text between the % signs will be automatically filled in by data when the file is created. These %text% strings are “system tags” or wildcard values that are understood by the TouchStream software. There are many additional system tags that you may find useful (e.g. %R% is output resolution). You can modify the file name by pressing in the name field to open a keyboard panel. You can add your own text to the preset file names, add additional system tags, or create your own file names without system tags. When using system tags, text can be inserted before, after or between system tags, but do not change the text between the paired % signs.

Keep in mind that you will overwrite an existing file if you do not change the file name for each encode, or include a system tag that automatically changes the file name for each encode.

Rollover: Projects that output Windows Media 9 (WM9) support an additional Rollover option. Note that file rollover is not frame accurate, that is, you will lose a few seconds between the end of one file and the beginning of the next file.

Rollover file names that include system tags (the %text% wildcards) will use the values that are valid at the beginning of the encode session, and will not change as each new rollover file is created. For example, if you are using the %PROJ.STIME_% time tag, and you start encoding at 10am with a rollover duration of 30 minutes, the time tag will be 10am for all of the files. An auto-incrementing number is used when rollover files are created.

Broadcast Output

Most projects include default settings for broadcasting a live stream. Some projects include just one type of streaming output while others include more than one type. Be sure to disable the ones you do not plan to use by pressing the check mark to clear the “Enable” box.

- ASF and WM9 Projects: These projects include both Push and Pull output options.

The Push settings include all the information you need to send the stream to the Windows Media Server.

The Pull setting is simply the HTTP Port that will be open for the Media Server or a small number of direct clients to use to pull the data.

- Dicas Projects (for Mobile): These projects can multicast the stream or they can send the stream to an external media server that can use an SDP file, such as a Darwin Media Server.

The multicast option uses the IP address you provide and also creates an SDP file at the default location.

The external option sends the stream to the server at the IP address and port specified, and creates an SDP file on the media server. For media servers that need authorization you can specify the username and password.

Note that the Dicas projects that have been installed on your TouchStream unit include 3 output streams in each project. Be sure to configure the output for all 3 output streams.

- Flash (DRC AVC for Web) Projects: The Flash projects have Push, Pull and Archive versions. (You cannot use Flash push and pull simultaneously.) The Push version allows you to push to both a Flash Media Server or to a Media Server that can use an SDP file. When you are selecting a Flash broadcast project be sure to choose the correct broadcast type, Push or Pull.

Push projects send to a Flash Media Server URL default of `rtmp://localhost:1935/live` with a Stream name of Default, and assumes the server does not require username/password authentication. You can modify any of these settings.

Push projects also can be used to send to an external media server that can use an SDP file, such as a Darwin Media Server.

The multicast option uses the IP address you provide and also creates an SDP file at the default location.

The external option sends the stream to the server at the IP address and port specified, and creates an SDP file on the media server. For media servers that need authorization you can specify the username and password.

Pull projects make the stream available over the specified port.

You cannot disable the Archive option on Flash Projects. If you do not need to create an archive file, then select a Flash Project that does not include Archive.

- On2 FLV Projects (Flash 8): These projects push to a Flash Media Server URL default of `rtmp://localhost:1935/live` with a Stream name of Default, and assumes the server does not require username/password authentication. You can modify any of these settings.

Note that On2 projects can only be used with the older Flash Media Server version 3.0. They are not compatible with the newer versions of the Flash Media Server.

- On2 SWF Projects (Flash 8): These projects can only be used to make archive files. They cannot be used for Broadcast.

- RTP Projects (included with the TS model): Each RTP project has both a Push and a Pull version. (You cannot use RTP push and pull simultaneously.) When you are selecting a project be sure to choose the correct broadcast type, Push or Pull.

The push projects can multicast the stream or they can send the stream to an external media server that can use an SDP file, such as a Darwin Media Server.

The multicast option uses the IP address you provide and also creates an SDP file at the default location (C:\Documents and Settings\All Users\Documents\Digital Rapids\Stream\SDP).

The external option sends the stream to the server at the IP address and port specified, and creates an SDP file on the media server. For media servers that need authorization you can specify the username and password.

The Pull projects make the stream available over the specified port.

The RTP projects installed with your TouchStream unit have not been set up to create an archive file while broadcasting. If you require this option you will have to create new projects specifically for that purpose.

- TS Projects: These projects send the stream to the specified IP address and port. They can use UDP or RTP with RTSP. As well, some of the projects are preset to use the H264 video codec and AAC audio codec and some have been preset to use the MPEG2 video codec and MPEG audio. When you are selecting a project be sure to choose the correct broadcast type, RTP/RTSP or UDP, and the correct codecs.

Video Settings and Audio Settings

The Video Settings and Audio Settings are available from both the Setup screen and from the Main screen. Please see the following sections for detailed information.

Video Settings

The video settings adjust the video image using the capture hardware that has been integrated into the TouchStream. These settings can be pre-set before you start encoding, or they can be adjusted on the fly during encoding (with the exception of cropping).

Note that Video Settings are global settings that are overwritten when you click the Done button and return to the main screen. That is, the settings are not saved with any individual project, they are saved and applied to all projects on the TouchStream unit and to all output streams in the loaded project (if your project includes more than one output stream).

There are four types of video settings. The currently selected feature is displayed in the panel to the right of the screen. The three other features can be selected using the buttons at the bottom left of the screen.

Graphic Overlay

You can use a graphic overlay to add an overlay to your video that can be used as a logo, watermark, title board or slate (for example).

For a graphic with an alpha channel, you can use a 32-bit bmp file or a 32-bit Photoshop psd file. A 32 bit bmp sample and a Photoshop psd file that shows how this bmp file was created is located in the Overlays folder in your Stream directory. Note that the 32-bit bmp file does use the alpha channel in the file to determine the transparency for the graphic overlay. However, if you use a Photoshop file the transparency in the file will be used to determine the transparency for the graphic overlay and NOT the alpha channel in the Photoshop file.

Graphic overlay files must be created with the graphic sized and positioned properly for the encoding session. Graphics cannot be sized or positioned within the TouchStream interface.

To select the graphic overlay file press the thumbnail region at the bottom left hand corner.



Set the “Fade Amount” or the maximum opacity of the overlay (what it will look like when it has finished the “Fade In”). Set the “Fade Duration”, or the time it will take to fade in or fade out in seconds. Use the round Fade In and Fade Out buttons to test your fade duration.

Note: If you change the graphic overlay while you are streaming, any changes you make will be seen immediately in the encoded video.

Once you have set the graphic overlay you will also be able to use the Fade In and Fade Out buttons on the main screen to control the overlay.

Picture Controls

The picture controls adjust the brightness, contrast and color saturation. As you adjust the sliders you will see the changes used in the video preview. You can use the button at the bottom of each slider to reset the slider to the default value.

Note that when you are using a graphic overlay, changes to the picture controls will not affect the graphic overlay, they will just affect the video.

Noise Reduction

Removing noise from the video will improve the quality of the encoded video by allowing the codec to allocate bits to real picture data. There are two types of noise reduction that can be adjusted in the TouchStream interface.

Spatial Noise Reduction

Spatial or 2D noise reduction is commonly used to remove single pixel 'salt and pepper' type noise such as video dropouts. Spatial noise reduction only affects the current frame of video, specifically targeting high frequency noise which is not part of the structure of the image. It specifically attempts to deal with high frequency noise which is not part of the edge of an object in the picture or other structures in the video.

There are three settings for 2D noise reduction:

- None: No noise reduction is applied
- Optimal: A predetermined amount of noise reduction is applied. This has been determined by testing with many hours of video.
- Extreme: A greater amount of noise reduction is applied at some loss of overall picture sharpness.

Spatial or 2D noise reduction is not available for the HDi (HD/SD SDI) models.

Temporal Noise Reduction

Temporal noise reduction is commonly used to remove low level noise such as film grain, tape noise or noise caused by low lighting levels. Note that Temporal Noise Reduction will only be used if hardware deinterlacing is enabled in the project.

Temporal noise reduction compares images in sequence over a predetermined period of time, blending the images between fields or frames. The theory is that by blending data over time you can reduce the overall noise content of the resulting image. Successive samples of the same scene are blended together which will effectively cancel out the noise found in any individual frame. The problem with typical noise reduction algorithms is that if there is any motion in the individual scene you will get a motion blur (trails) artifact in the processed frame.

TouchStream uses a very advanced form of temporal noise processing called motion adaptive 3D noise reduction. Motion adaptive 3D noise reduction combines the information in multiple frames of video using the information obtained from the motion adaptive de-interlacing in order to decide how much processing is applied to each pixel in the final frame. Because each pixel is calculated individually the result will be more precise noise reduction with less motion blurring artifacts than would otherwise normally be possible.

Adjust the Temporal noise reduction by using the slider, or by pressing one of the three buttons (None, Optimal, Extreme) to move the slider to a pre-set position.

Cropping

Cropping controls how much video is removed from the top, bottom, and sides of the incoming video. Typical uses of cropping:

- remove the black areas which often surround a video image (known as 'underscan')
- remove the letterbox black (the black bars above and below the image found in letterboxed material) off a 4x3 input that will be encoded at 16x9
- crop the sides of a 16x9 input to fit a 4x3 encode session, provided the production was done 4x3 safe

Note that when you remove lines from the video, you are not changing the size used by the video output. For example, if you crop 20 lines from the height of your video, the picture will be "stretched" to fit the size that was specified as the video output size in the project. If you don't want this to happen, you must also modify the project to reduce the vertical height of the output by 20 lines.

Audio Settings

The audio settings adjust the audio using the capture hardware that has been integrated into the TouchStream. These settings can be pre-set before you start encoding, or they can be adjusted on the fly during encoding.

Note that Audio Settings are global settings that are overwritten when you click the Done button and return to the main screen. That is, the settings are not saved with any individual project, they are saved and applied to all projects on the TouchStream unit and to all output streams in the loaded project (if your project includes more than one output stream).

Levels

The audio levels for each channel can be individually adjusted from the default of 0 dB (use the audio level of the source) up to +18 dB or down to -80 dB.

Note that you can also adjust the master audio level on the main screen, adjusting all channels at once.

Bass/Treble

The Bass and Treble sliders can be used to adjust the levels from the default of 0 dB (use the level of the source) up to +18 dB or down to -18 dB.

Bass Treble settings are not available for the HDi (HD/SD SDI) models.

Audio Pass-Through for Monitoring

If you connect speakers or headphones to the audio output on the back of the TouchStream unit you will be able to monitor the audio input. The stereo pair that you are monitoring will be the pair that is selected on the TouchStream screen (selection indicated by a blue highlight at the bottom of the audio slider).

Info

When you press the Info button you will see information about the currently loaded project on the left side and information about the hardware and status on the right hand side.

There are also four buttons for additional functions.

- **Email Config** can be used to send information about your unit to Digital Rapids Support should you need assistance.
- **Network Settings** button can be used to select between automatic and manual network configuration.
- **Reset** will reset all user settings for audio, video, trigger and output settings to their default values. After pressing this button you can select Cancel if you want to retain your current settings.
- **Security** will give you options to Lock all controls on the TouchStream interface. It also gives you access to the Restrictions options, which allows you to hide only the functions you specify.

The screenshot displays the 'Info' screen of the TouchStream software. It is divided into two main columns of text and a bottom navigation bar. The left column contains system and project information, while the right column contains network and streaming details. A vertical progress bar is positioned between the two columns. The bottom navigation bar features five circular icons: an envelope for 'Email Config', a globe for 'Network Settings', a circular arrow for 'Reset...', a padlock for 'Security', and a checkmark for 'Done'. At the very bottom, a status bar shows 'Armed for Manual start. Current time is 15:52:37' and a small circular icon on the right.

Info

TouchStream version: 1.1.0b39
OS: Windows XP 5.1 Service Pack 3

Project: WM9_640x480p29_2Mbps.prj

Codec Profile: WM9_CBR_640x480_2Mbps_Stereo_192Kbps
Language: English

Audio mode: CBR
Audio codec: Windows Media Audio 9

Video mode: CBR
Video codec: Windows Media Video 9

Stream 1
Audio format: 192kbps, 48000 Hz, stereo CBR

Hostname: SHARI-XEON
Connection state: Connected
IP address: 192.168.0.114
Default Route: 192.168.0.1
Primary DNS: 192.168.0.11
Secondary DNS: 192.168.0.15
Streaming port:
Hardware ID: 0x0132011F0A020102
Buffer usage: 6%
Dropped frames: 0
CPU: 9%
Frame rate: 29.98 fps
Video time: 00:01:28
Audio time: 00:01:28

Email Config Network Settings Reset... Security Done

Armed for Manual start. Current time is 15:52:37

Email Config

The Email Config button shows technical information about the unit that can be used for troubleshooting. If you are having an issue with your unit and you contact Digital Rapids Support for assistance they may direct you to use the Email option on this Info screen. This will email the unit's information, along with the project and input settings in use at the time, directly to Digital Rapids Support.

Network Settings

After you have physically connected the TouchStream unit to the network with a cable, you may have to configure the network settings using the TouchStream software. The system default is to automatically obtain an IP address and DNS if the network supports this capability. Otherwise you will need to ask your network administrator for the appropriate IP settings and you will have to enter them manually. Please see [Connecting to the Network](#) on page 5 for more information.

Reset

To return the TouchStream configuration settings to the default settings that are used when the software is first installed, press this button. You will see a warning window that will allow you to confirm or cancel the reset.

Security: Lock

Lock allows you to lock and hide all controls on the TouchStream interface.

Be sure to configure all settings and to arm the Trigger for a GPI or Scheduled start and stop. Do not use a manually triggered start and stop, as the trigger button will also be locked.

From the main Security screen you must enter the Lock Settings password to enable the Lock button. By default the password is *touchstream*. If you want to change this password touch the Change Password button, enter the current password, enter a new password and touch Set.

Once you have enabled the Lock button by entering the password, touching the Lock button returns you to the main interface with only two buttons showing: Trigger and Unlock. The Trigger button is only shown for status, it cannot be used to trigger an encode. If you click the Unlock button you will need to enter the Lock Settings password to unlock the interface.

You can also lock the unit after it has already started encoding to prevent accidentally stopping the encode. In that case the Red Streaming button will also be shown on the interface.

Security: Restrictions

The Restrictions function on the Security screen allows you to select specific functions on the TouchStream interface that will be hidden (restricted).

To enable the Restrictions button you must enter the Restrictions Password. By default the restrictions password is *admin*. If you want to change this password touch the Change Password button, enter the current password, enter a new password and touch Set. Once you have enabled the Restrictions button by entering the password, touch the button to go to the Restrictions screen.

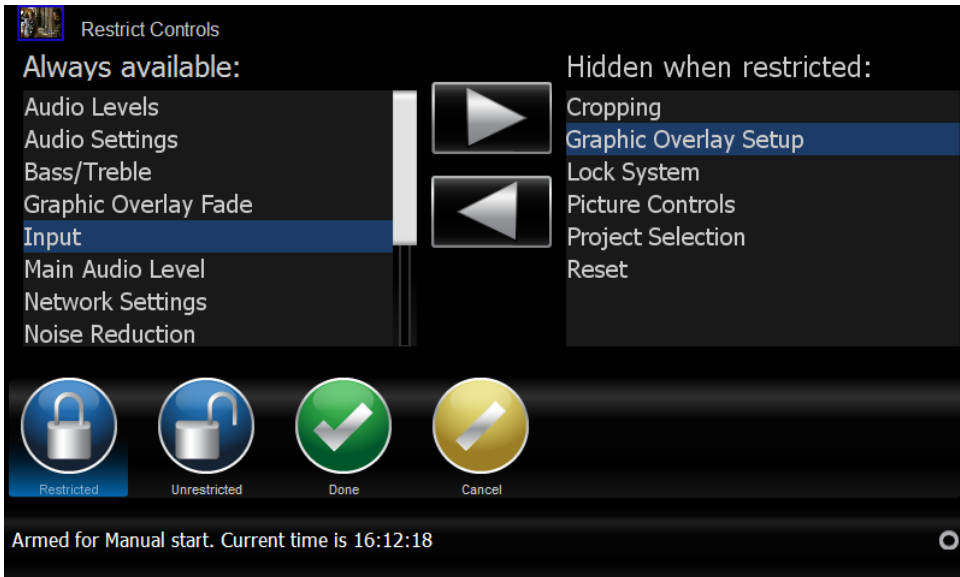

This shows a list of functions in two columns, one for functions that are “Always available” and a second that will be used to determine which functions are “Hidden when restricted”. To move a function from one column to the other select it in the list and then use the arrows between the columns to move the function.

When you press the blue Restricted button the functions in the “Hidden when restricted” list will be hidden from the interface. When you press the blue Unrestricted button the functions in the “Hidden when restricted” list will once again be shown (unrestricted), but will not be moved from the Restricted list.

There are two special functions in the list: Trigger and Start/Stop

Trigger: Before you restrict Trigger ensure that you have a valid trigger set up.

Once this function is restricted the Trigger button will be shown on the main screen but hidden on the Setup screen. In addition, when the TouchStream unit is not currently encoding the Trigger button will always be armed. The trigger will be armed each time you power on the system as well.

Note that when Trigger is not restricted, each time you end an encode the Trigger will be disarmed.

Start/Stop: Before you restrict Start/Stop ensure you have a valid trigger and project set up.

Once Start/Stop has been restricted the system will start encoding each time the power is turned on. It will only stop when the power is turned off. To change this behavior the Start/Stop restriction would need to be removed using the Restrictions interface.

Customizing TouchStream Projects

If you are not familiar with the Digital Rapids Stream or Stream Live software, you should contact Digital Rapids Support for help customizing your projects. Please see [Contact Information](#) on page 43 for the Support office in your region.

Files that you may want to access are stored in a shared directory, to allow remote updates from another system on the same LAN. To access these folders from another computer, you will need to browse to the TouchStream's drive and use the username touchstream with password touchstream.

Shared files are located in the following sub directories:

- **Projects:** The projects contain the encoder output settings (codec profiles), detailed output settings, and some additional settings that will be used by TouchStream unit when running an encode.
- **SourceProfiles:** These are the Input Settings used to select the video and audio inputs used. If you create new source profiles be sure to name the first audio in the source profile "Audio 1", no matter which audio input was used, so that the inputs will be compatible with the TouchStream projects that are installed with the unit.
- **Overlays:** These are the graphics used by the Video Settings Graphic Overlay. The unit supports 32-bit and 24-bit BMP and Photoshop PSD files, as well as 24-bit JPG/JPEG files.
- **SDP:** If you are using a broadcast output that generates SDP files, they will be found in this folder.
- **Documentation:** These files have been included for reference. Some of them contain advanced codec information that you will only need if you are creating your own projects.

If you plan to modify TouchStream projects you must close the TouchStream software on your unit (using ALT F4) and launch the TouchStream Config software (a version of the Stream Live software). If you plan to do this you should access the TouchStream unit using Windows Remote Desktop, as the Stream

Live software has not been designed to operate at the resolution required by the touch screen interface. Note that if you connect a monitor, keyboard and mouse to the TouchStream unit **do not change the default screen resolution** of the unit as the touch screen only operates at a specific resolution, and once it has been changed it is not easy to reset the resolution.

The files that are used by the TouchStream unit are located in the sub directories of C:\Documents and Settings\All Users\Documents\Digital Rapids\Stream.

After using the TouchStream Config software you must exit from that application before you will be able to launch the TouchStream software. To restart the TouchStream software you can use the Start menu to choose Start > Programs > Startup > TouchStream, or you can press the power switch and choose restart.

GPI - General Purpose Interface

GPI triggers are physical connections between two pieces of equipment. GPI triggers are typically based on a change of state on a monitored pin of the serial port. For instance you could create a GPI trigger which was operated by a toggle switch, by the alarm closure of an alarm system, or a port on a piece of broadcast equipment.

GPI cables should be custom manufactured by someone who has adequate knowledge of both pieces of equipment to be connected. If you plan to use a GPI trigger but you are not comfortable reading electrical schematics and building custom cables you should provide the included schematic to a qualified technical engineer.

The Touch Stream software can use a GPI interface to trigger starting and/or stopping encoding. A GPI cable can be made using the following wiring diagram.

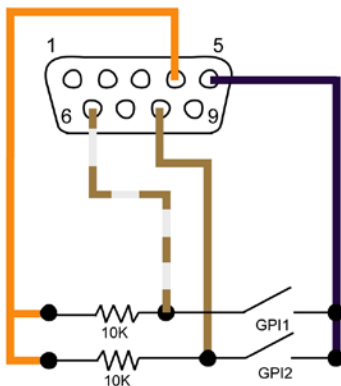

Signal Name	Wire Color	DB-9
Data Terminal Ready	Orange	4
Common Ground	Blue	5
Data Set Ready (GPI)	White/Brown	6
Clear to Send (GPI)	Brown	8

TouchStream System Specifications

NOTES: Specifications subject to change without notice.
Systems may vary slightly from region to region.

Typical TouchStream system:

Custom designed chassis

Physical dimensions: 15.8"D x 8.8"W x 5.6"H (5.2"H with feet removed)

Maximum operating temperature: 35 C

250W Power Supply

1x Intel Core2 Quad 2.40 GHz

1GB of DDR3 RAM

Touch Screen panel on front of unit

On board graphics

Window XP Embedded OS

Ports on a TouchStream system:

USB - 2 ports

Ethernet - 1 port (RJ-45)

Fire Wire - 2 ports

VGA 15-pin port

Mouse port (PS-2)

Keyboard port (PS-2)

Speakers 1/8" mini-jack (2)

Head Set 1/8" mini-jack (2)

Head Phone 1/8" mini-jack (1)

Microphone 1/8" mini-jack (1) (not a streaming input)

Video and Audio inputs depend on the DRC capture card installed in the chassis.

DRC-Stream PCI Card Specifications

DRC-500

Form Factor

Half Length, Full Height PCI 64 bit /66Mhz
(32bit /33Mhz compatible)

Total power consumption: typical 6.25W; maximum 10W

3.3V 0.9A 3W

5V 0.6A 3W

12V 0.02A 0.25W

Video and Audio Inputs

Supports NTSC and PAL video standards

1 Composite Video (RCA)

1 S-Video (Mini Din)

2 Unbalanced Audio (L+R) on RCA

4 Balanced Stereo Audio inputs on XLR

Hardware Video Processing

Motion adaptive de-interlacing

Noise reduction (3D and 2D)

Aspect ratio conversion

Cropping and Scaling

Proc amp control

Gamma correction

Graphics overlay

Hardware Audio Processing

48kHz - 24 bits/sample

7-band parametric EQ per channel

Dynamic range compression / expansion

Hardware sample rate conversion

Volume control; Bass and Treble control

DRC-1600

Form Factor

Full Length, Full Height PCI 64 bit /66Mhz (32bit /33Mhz compatible)

Power Requirements

~ 25 Watts

+3.3V - 3.5A

+5V - 1.5A

-5V - 0A

+12V - 0.5A

-12V - 0.1A

General

NTSC or PAL inputs (user-selectable)

One video processing channel

Up to 8 mono channels of audio processing.

Full Length PCI Interface - 64 bit 66MHz

Real-Time hardware based video pre-processing

Motion adaptive de-interlacing

Vertical Temporal de-interlacing

3:2 and 2:2 film process de-interlacing (inverse telecine)

Arbitrary Shrink/Zoom

3D noise reduction

2D bandwidth limiting (independent horiz and vert)

Aspect Ratio conversion

Graphics overlay

Cropping

Proc-amp controls

Color balance and correction

Real-time Hardware based Audio processing

20 bit internal processing

7- Band Parametric EQ (4/8)

Dynamic Range Compression

Bass and Treble control

Volume control

Digital Video and Audio inputs:

Serial SDI (SMPTE 259M) (BNC) 800mv, 75 Ohm

Embedded audio conforming to SMPTE-272M is supported on the SDI input

Optional Analog Video inputs (requires breakout cable or breakout box):

Composite (BNC) 1V p-p, 75 Ohm

S-Video: (4-Pin Mini-DIN)

Y Signal 1V p-p, 75 Ohm

C Signal 286mV p-p (NTSC) 300mv p-p (PAL)

Component Betacam (BNC's):

Y Signal 1V p-p, 75 Ohm

R-Y, B-Y (Pr,Pb) 700mV p-p (NTSC) 525mv p-p (PAL)

Note: Video inputs levels correspond to 75% color bar signal, with 100% white reference bar.

Optional Audio Inputs (requires breakout cable or breakout box):

Analog Audio:

Balanced (XLR-F) +4 dBU Nominal

Unbalanced Line (RCA) -10 dBV Nominal

Digital Audio Inputs:

AES/EBU (EIAJ CP-340, XLR) 5V Balanced, 110 Ohm

DRC- 5650

Form Factor

Full Length, Full Height PCI 64 bit /66Mhz

(32bit /33Mhz compatible)

Note: All features of the board may not be enabled in all versions of the software.

HD-SDI and SD-SDI (SMPTE-292M and SMPTE-259M)

Video Resolutions

1080i, 1080p, 1080psf, 1035i, 720p

SD Resolutions: 480i (NTSC), 576i (PAL)

Pixel format: 4:2:2 YCbCr

Full 8 and 10-bit support for all formats

Frame rates: 60Hz, 59.94Hz, 50Hz, 49.95 Hz, 30Hz,

29.97Hz, 25Hz, 24.975Hz, 24Hz, 23.976Hz

Video Processing Features

Format conversion from any input format to any output format (HD to SD, SD to HD, HD to HD)

Motion adaptive de-interlacing during format conversion

Cropping and scaling

Proc Amp controls
Gamma correction
Filtering and noise reduction

Graphics Overlay
High speed graphics buffer with alpha channel
Overlay graphics during record or playback

Video Input (on PCI board or Breakout Box)
1 x BNC multi-format HD-SDI and SD-SDI

Audio Inputs (on PCI board or Breakout Box)
Embedded SDI audio (16 channels, 24-bit, 32/44.1/48 kHz)

Audio Inputs (on Breakout Box)
4 x XLR female (AES/EBU Stereo, 24-bit, 32/44.1/48/96 kHz)

Genlock Input (on PCI board or Breakout Box)
1 x BNC analog sync
Supports Bi-level or Tri-level sync
Supports all SD and HD formats

Genlock Output (on Breakout Box)
1 x BNC analog sync
Supports Bi-level or Tri-level sync
Supports all SD and HD formats

GPI (on Breakout Box)
2 x RCA female (GPI Inputs)
2 x RCA female (GPI Outputs)

LTC (on Breakout Box)
1 x XLR female (LTC Input)
1 x XLR male (LTC Output)

Regulatory Certifications and Compliance

The TouchStream chassis complies with the following safety regulations.

Safety

U.S., Canada UL60950-1– CSA C22.2 no. 60950-1-07 950 (UL and cUL)
Europe, CE Mark IEC EN60950-1:2005 International
IEC60950 (CB Report and Certificate)

Electromagnetic Capability (EMC)

U.S. FCC, Part 15, Subpart B, Class A

Digital Rapids TouchStream complies with the following standards.

The EMC Directive

Standards to which Conformity is Declared

CISPR 22:2008-09/EN55022:2006 - Class A - Limits and methods of measurement of radio disturbance characteristics of Information Technology Equipment

CISPR 24:1997 +A1:2001 +A2:2002 / EN 55024:1998 +A1:2001 +A2:2003 - Information Technology Equipment - Immunity Characteristics - Limits and Methods of Measurements

FCC Rules

This device complies with Part 15 of the FCC Rules. Operation is subject to the following two conditions:

- (1) this device may not cause harmful interference and
- (2) this device must accept any interference received, including interference that may cause undesired operation.

FCC Part 15, Subpart B, Class A Unintentional Radiators for Use in Commercial and Industrial Areas.

Warning:

This is a class A product. In a domestic environment this product may cause radio interference in which case the user may be required to take adequate measures.

RoHS Compliance

Digital Rapids Corporation is committed to complying with environmental regulations such as the European Union (EU) directive 2002/95/EC (commonly known as the European Union Restriction on Hazardous Substances, or RoHS), California substance restriction requirements, and other international initiatives.

Digital Rapids' current family of hardware cards – including the DRC-500, DRC-1000, DRC-1400, DRC-1600, DRC-2000, DRC-2400, DRC-2600 and DRC-5650 boards – are compliant with the RoHS initiative. Our compliant products bear our RoHS compliant symbol on our packaging.

Our turnkey server systems, including TouchStream, StreamZ and StreamZHD, are comprised of the above-listed hardware cards combined with third-party computer components which are themselves subject to RoHS compliance by their respective manufacturers.

WARNING: English (USA)

The power supply in this product contains no user-serviceable parts. Refer servicing only to qualified personnel.

Do not attempt to modify or use the supplied AC power cord if it is not the exact type required.

The power button on the system does not turn off system AC power. To remove AC power from the system, you must unplug the AC power cord from the wall outlet or power supply.

The power cord is considered the disconnection device to the mains (AC) power. The socket outlet that the system plugs into shall be installed near the equipment and shall be easily accessible.

SAFETY STEPS: Whenever you remove the chassis cover to access the inside of the system, follow these six steps:

1. Turn off all peripheral devices connected to the system.
2. Turn off the system by pressing the power button.
3. Unplug all AC power cords from the system or from wall outlets.
4. Label and disconnect all cables connected to I/O connectors or ports on the back of the system.
5. Provide some electrostatic discharge (ESD) protection by wearing an antistatic wrist strap attached to chassis ground of the system—any unpainted metal surface—when handling components.
6. Do not operate the system with the chassis cover removed.

After you have completed the six previous SAFETY steps, you can remove the system cover.

For proper cooling and airflow, always reinstall the chassis covers before turning on the system. Operating the system without the cover in place can damage system parts. To install the cover:

1. Check first to make sure you have not left loose tools or parts inside the system.
2. Check that cables, add-in boards, and other components are properly installed.

3. Attach the cover to the chassis with the screws removed earlier, and tighten them firmly.
4. Connect all external cables and the AC power cord(s) to the system.

A microprocessor and heat sink may be hot if the system has been running. Also, there may be sharp pins and edges on some board and chassis parts. Contact should be made with care. Consider wearing protective gloves.

Danger of explosion if the battery is incorrectly replaced. Replace only with the same or equivalent type recommended by the equipment manufacturer. Dispose of used batteries according to manufacturer's instructions.

The system is designed to operate in a typical office environment. Choose a site that is:

- Clean and free of airborne particles (other than normal room dust).
- Well ventilated and away from sources of heat including direct sunlight.
- Away from sources of vibration or physical shock.
- Isolated from strong electromagnetic fields produced by electrical devices.
- In regions that are susceptible to electrical storms, we recommend you plug your system into a surge suppresser and disconnect telecommunication lines to your modem during an electrical storm.
- Provided with a properly grounded wall outlet.
- Provided with sufficient space to access the power supply cord(s), because they serve as the product's main power disconnect.

AVERTISSEMENT: Français

Le bloc d'alimentation de ce produit ne contient aucune pièce pouvant être réparée par l'utilisateur. Ce produit peut contenir plus d'un bloc d'alimentation. Veuillez contacter un technicien qualifié en cas de problème.

Ne pas essayer d'utiliser ni modifier le câble d'alimentation CA fourni, s'il ne correspond pas exactement au type requis. Le nombre de câbles d'alimentation CA fournis correspond au nombre de blocs d'alimentation du produit.

Notez que le commutateur CC de mise sous tension /hors tension du panneau avant n'éteint pas l'alimentation CA du système. Pour mettre le système hors tension, vous devez débrancher chaque câble d'alimentation de sa prise.

CONSIGNES DE SÉCURITÉ -Lorsque vous ouvrez le boîtier pour accéder à l'intérieur du système, suivez les consignes suivantes:

1. Mettez hors tension tous les périphériques connectés au système.
2. Mettez le système hors tension en mettant l'interrupteur général en position OFF (bouton-poussoir).
3. Débranchez tous les cordons d'alimentation c.a. du système et des prises murales.
4. Identifiez et débranchez tous les câbles reliés aux connecteurs d'E-S ou aux accès derrière le système.
5. Pour prévenir les décharges électrostatiques lorsque vous touchez aux composants, portez une bande antistatique pour poignet et reliez-la à la masse du système (toute surface métallique non peinte du boîtier).
6. Ne faites pas fonctionner le système tandis que le boîtier est ouvert.

Une fois TOUTES les étapes précédentes accomplies, vous pouvez retirer les panneaux du système. Procédez comme suit:

1. Si un cadenas a été installé sur à l'arrière du système, déverrouillez-le et retirez-le.
2. Retirez toutes les vis des panneaux et mettez-les dans un endroit sûr.
3. Retirez les panneaux.

Afin de permettre le refroidissement et l'aération du système, réinstallez toujours les panneaux du boîtier avant de mettre le système sous tension. Le

fonctionnement du système en l'absence des panneaux risque d'endommager ses pièces. Pour installer les panneaux, procédez comme suit:

1. Assurez-vous de ne pas avoir oublié d'outils ou de pièces démontées dans le système.
2. Assurez-vous que les câbles, les cartes d'extension et les autres composants sont bien installés.
3. Revissez solidement les panneaux du boîtier avec les vis retirées plus tôt.
4. Remettez le cadenas en place et verrouillez-le afin de prévenir tout accès non autorisé à l'intérieur du système.
5. Rebranchez tous les cordons d'alimentation c. a. et câbles externes au système.

Le microprocesseur et le dissipateur de chaleur peuvent être chauds si le système a été sous tension. Faites également attention aux broches aiguës des cartes et aux bords tranchants du capot. Nous vous recommandons l'usage de gants de protection.

Danger d'explosion si la batterie n'est pas remontée correctement. Remplacer uniquement avec une batterie du même type ou d'un type équivalent recommandé par le fabricant. Disposez des piles usées selon les instructions du fabricant.

Le système a été conçu pour fonctionner dans un cadre de travail normal. L'emplacement choisi doit être:

- Propre et dépourvu de poussière en suspension (sauf la poussière normale).
- Bien aéré et loin des sources de chaleur, y compris du soleil direct.
- A l'abri des chocs et des sources de vibrations.
- Isolé de forts champs électromagnétiques géenérés par des appareils électriques.
- Dans les régions sujettes aux orages magnétiques il est recommandé de brancher votre système à un supresseur de surtension, et de débrancher toutes les lignes de télécommunications de votre modem durant un orage.
- Muni d'une prise murale correctement mise à la terre.
- Suffisamment spacieux pour vous permettre d'accéder aux câbles d'alimentation (ceux-ci étant le seul moyen de mettre le système hors tension).

Warranty

Limited Warranty for Digital Rapids TouchStream

Digital Rapids warrants that the product (defined herein as TouchStream and all of its various components and software delivered with or as part of the Products) to be delivered hereunder, if properly used and installed, will be free from defects in material and workmanship and will substantially conform to Digital Rapids specifications for a period of two (2) years after the date the Product was purchased from a Digital Rapids authorized distributor. Software of any kind delivered with or as part of products is expressly provided “as is” unless specifically provided for otherwise in any software license accompanying the software.

If any Product furnished by Digital Rapids which is the subject of this Limited Warranty fails during the warranty period for reasons covered by this Limited Warranty, Digital Rapids, at its option, will:

- REPAIR the Product by means of hardware and/or software; OR
- REPLACE the Product with another

If such Product is defective, transportation charges for the return of Product to buyer within North America will be paid by Digital Rapids. For all other locations, the warranty excludes all costs of shipping, customs clearance, and other related charges. Digital Rapids will have a reasonable time to make repairs or to replace Product. In no event will Digital Rapids be liable for any other costs associated with the replacement or repair of Product, including labor, installation or other costs incurred by buyer and in particular, any costs relating to the removal or replacement of any product soldered or otherwise permanently affixed to any printed circuit board. This Limited Warranty, and any implied warranties that may exist under some United States laws, apply only to the original purchaser of the Product.

Extent of Limited Warranty

Digital Rapids does not warrant that Products to be delivered hereunder, whether delivered stand-alone or integrated with other Products, including without limitation semiconductor components, will be free from design defects or errors known as “errata”. Current characterized errata are available upon request. This Limited Warranty does not cover damages due to external causes, including accident, problems with electrical power, usage not in accordance with product instructions, misuse, neglect, alteration, repair, improper installation, or improper testing.

Warranty Limitations and Exclusions

These warranties replace all other warranties, expressed or implied including, but not limited to, the implied warranties of merchantability and fitness for a particular purpose. Digital Rapids makes no expressed warranties beyond those stated here. Digital Rapids disclaims all other warranties, expressed or implied including, without limitation, implied warranties of merchantability and fitness for a particular purpose. Some jurisdictions do not allow the exclusion of implied warranties, so this limitation may not apply. All expressed and implied warranties are limited in duration to the limited warranty period. No warranties apply after that period. Some jurisdictions do not allow limitations on how long an implied warranty lasts, so this limitation may not apply to you.

Limitations of Liability

Digital Rapids responsibility under this, or any other warranty, implied or expressed, is limited to repair or replacement as set forth above. These remedies are the sole and exclusive remedies for any breach of warranty. Digital Rapids is not responsible for direct, special, incidental, or consequential damages resulting from any breach of warranty under another legal theory including, but not limited to, lost profits, downtime, goodwill, damage to or replacement of equipment and property, and any costs of recovering, reprogramming, or reproducing any program or data stored in or used with a system containing this product. Some jurisdictions do not allow the exclusion or limitation of incidental or consequential damages, so the above limitations or exclusions may not apply to you. This limited warranty gives you specific legal rights, and you may also have other rights that vary from jurisdiction to jurisdiction. Any and all disputes arising under or related to this Limited Warranty shall be adjudicated in the following forums and governed by the following laws: for the United States of America, Canada, North America and South America, the forum shall be Toronto Canada and the applicable law shall be that of the City of Toronto, Canada. For Europe and the rest of the world, the forum shall be London UK and the applicable law shall be that of the United Kingdom. In the event of any conflict between the English language version and any other translated version(s) of this Limited Warranty, the English language version shall control.

Contact Information

North and South America

Digital Rapids Corporation
90 Allstate Parkway, Suite 700
Markham, Ontario L3R 6H3
Canada

905-946-9666 voice
416-352-0716 fax

Sales: sales.na@digital-rapids.com; 905-946-9666 x 212 (North America)
sales.la@digital-rapids.com; +54-11-4700-0051 (Latin America)

Technical Support: support.na@digital-rapids.com
905-944-3513 (direct dial)
or using the main line: 905-946-9666 x 113

General and OEM: info@digital-rapids.com

Europe, Africa, Middle East

Digital Rapids Corporation Ltd.
Passfield Business Centre
Lynchborough Road
Passfield
Hampshire
GU30 7SB
UK

+44-1428-751-012 voice
+44-1428-751-013 fax

Sales: sales.eu@digital-rapids.com; +44-1428-751-012

Technical Support: support.eu@digital-rapids.com; +44-1428-751-012

Asia Pacific

Digital Rapids Asia Ltd. (China)
Unit 10-18, 32/F, Tower 1, Millennium City 1
388 Kwun Tong Road, Kwun Tong
Kowloon, Hong Kong
China

+852-3972-2385 voice

+852-3972-2211 fax

Sales: sales.cn@digital-rapids.com; +852-3972-2385 (China)
sales.ap@digital-rapids.com; +61-2-9546-1300 (Australia)
sales.in@digital-rapids.com; +91 124 4354107 (India)

Technical Support:
support.cn@digital-rapids.com; +852-3972-2385 (China)



connecting content to opportunity

www.digital-rapids.com