

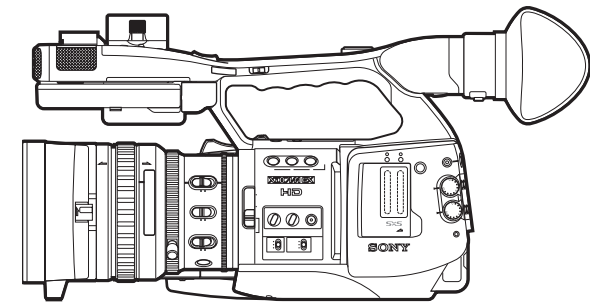

# Solid-State Memory Camcorder

*PMW-EX1R*



## Operating Instructions

Before operating the unit, please read this manual thoroughly and retain it for future reference.

## WARNING

**To reduce the risk of fire or electric shock, do not expose this apparatus to rain or moisture.**

**To avoid electrical shock, do not open the cabinet. Refer servicing to qualified personnel only.**

## WARNING

When installing the unit, incorporate a readily accessible disconnect device in the fixed wiring, or connect the power plug to an easily accessible socket-outlet near the unit. If a fault should occur during operation of the unit, operate the disconnect device to switch the power supply off, or disconnect the power plug.

## Important Safety Instructions

- Read these instructions.
- Keep these instructions.
- Heed all warnings.
- Follow all instructions.
- Do not use this apparatus near water.
- Clean only with dry cloth.
- Do not block any ventilation openings. Install in accordance with the manufacturer's instructions.
- Do not install near any heat sources such as radiators, heat registers, stoves, or other apparatus (including amplifiers) that produce heat.
- Do not defeat the safety purpose of the polarized or grounding-type plug. A polarized plug has two blades with one wider than the other. A grounding-type plug has two blades and a third grounding prong. The wide blade or the third prong are provided for your safety. If the provided plug does not fit into your outlet, consult an electrician for replacement of the obsolete outlet.
- Protect the power cord from being walked on or pinched particularly at plugs, convenience receptacles, and the point where they exit from the apparatus.
- Only use attachments/accessories specified by the manufacturer.
- Use only with the cart, stand, tripod, bracket, or table specified by the manufacturer, or sold with the apparatus. When a cart is used, use



caution when moving the cart/apparatus combination to avoid injury from tip-over.

- Unplug this apparatus during lightning storms or when unused for long periods of time.
- Refer all servicing to qualified service personnel. Servicing is required when the apparatus has been damaged in any way, such as power-supply cord or plug is damaged, liquid has been spilled or objects have fallen into the apparatus, the apparatus has been exposed to rain or moisture, does not operate normally, or has been dropped.

## IMPORTANT

The nameplate is located on the bottom.

## WARNING

Excessive sound pressure from earphones and headphones can cause hearing loss. In order to use this product safely, avoid prolonged listening at excessive sound pressure levels.

## For the customers in the U.S.A.

This equipment has been tested and found to comply with the limits for a Class A digital device, pursuant to Part 15 of the FCC Rules. These limits are designed to provide reasonable protection against harmful interference when the equipment is operated in a commercial environment. This equipment generates, uses, and can radiate radio frequency energy and, if not installed and used in accordance with the instruction manual, may cause harmful interference to radio communications. Operation of this equipment in a residential area is likely to cause harmful interference in which case the user will be required to correct the interference at his own expense.

You are cautioned that any changes or modifications not expressly approved in this manual could void your authority to operate this equipment.

All interface cables used to connect peripherals must be shielded in order to comply with the limits for a digital device pursuant to Subpart B of Part 15 of FCC Rules.

This device complies with Part 15 of the FCC Rules. Operation is subject to the following two conditions: (1) this device may not cause harmful interference, and (2) this device must accept any interference received, including interference that may cause undesired operation.

**For the customers in Canada**

This Class A digital apparatus complies with Canadian ICES-003.

**For the customers in Europe**

This product with the CE marking complies with the EMC Directive issued by the Commission of the European Community. Compliance with this directive implies conformity to the following European standards:

- EN55103-1 : Electromagnetic Interference(Emission)
- EN55103-2 : Electromagnetic Susceptibility(Immunity)

This product is intended for use in the following Electromagnetic Environments: E1 (residential), E2 (commercial and light industrial), E3 (urban outdoors), E4 (controlled EMC environment, ex. TV studio).

The manufacturer of this product is Sony Corporation, 1-7-1 Konan, Minato-ku, Tokyo, Japan.

The Authorized Representative for EMC and product safety is Sony Deutschland GmbH, Hedelfinger Strasse 61, 70327 Stuttgart, Germany. For any service or guarantee matters please refer to the addresses given in separate service or guarantee documents.

**For the State of California, USA only**

Perchlorate Material - special handling may apply, See [www.dtsc.ca.gov/hazardouswaste/perchlorate](http://www.dtsc.ca.gov/hazardouswaste/perchlorate)

Perchlorate Material : Lithium battery contains perchlorate.

**For the customers in the USA and Canada  
RECYCLING LITHIUM-ION BATTERIES**

Lithium-Ion batteries are recyclable.

You can help preserve our environment by returning your used rechargeable batteries to the collection and recycling location nearest you.

For more information regarding recycling of rechargeable batteries, call toll free 1-800-822-8837, or visit

<http://www.rbrc.org/>

Caution: Do not handle damaged or leaking Lithium-Ion batteries.



**For the customers in Taiwan only**



廢電池請回收

## AVERTISSEMENT

**Afin de réduire les risques d'incendie ou d'électrocution, ne pas exposer cet appareil à la pluie ou à l'humidité.**

**Afin d'écarter tout risque d'électrocution, garder le coffret fermé. Ne confier l'entretien de l'appareil qu'à un personnel qualifié.**

## AVERTISSEMENT

Lors de l'installation de l'appareil, incorporer un dispositif de coupure dans le câblage fixe ou brancher la fiche d'alimentation dans une prise murale facilement accessible proche de l'appareil. En cas de problème lors du fonctionnement de l'appareil, enclencher le dispositif de coupure d'alimentation ou débrancher la fiche d'alimentation.

## IMPORTANT

La plaque signalétique se situe sous l'appareil.

## AVERTISSEMENT

Une pression acoustique excessive en provenance des écouteurs ou du casque peut provoquer une baisse de l'acuité auditive.

Pour utiliser ce produit en toute sécurité, évitez l'écoute prolongée à des pressions sonores excessives.

## Pour les clients au Canada

Cet appareil numérique de la classe A est conforme à la norme NMB-003 du Canada.

## Pour les clients en Europe

Ce produit portant la marque CE est conforme à la Directive sur la compatibilité électromagnétique (EMC) émise par la Commission de la Communauté européenne.

La conformité à cette directive implique la conformité aux normes européennes suivantes :

- EN55103-1 : Interférences électromagnétiques (émission)
- EN55103-2 : Sensibilité électromagnétique (immunité)

Ce produit est prévu pour être utilisé dans les environnements électromagnétiques suivants : E1 (résidentiel), E2 (commercial et industrie légère), E3 (urbain extérieur) et E4 (environnement EMC contrôlé, ex. studio de télévision).

Le fabricant de ce produit est Sony Corporation, 1-7-1 Konan, Minato-ku, Tokyo, Japon.

Le représentant autorisé pour EMC et la sécurité des produits est Sony Deutschland GmbH, Hedelfinger Strasse 61, 70327 Stuttgart, Allemagne. Pour toute question concernant le service ou la garantie, veuillez consulter les adresses indiquées dans les documents de service ou de garantie séparés.

## Pour les utilisateurs aux Etats-Unis et au Canada.

## RECYCLAGE DES ACCUMULATEURS AUX IONS DE LITHIUM

Les accumulateurs aux ions de lithium sont recyclables.

Vous pouvez contribuer à préserver l'environnement en rapportant les piles usées dans un point de collection et recyclage le plus proche.

Pour plus d'informations sur le recyclage des accumulateurs, téléphonez le numéro gratuit 1-800-822-8837 (Etats-Unis et Canada uniquement), ou visitez <http://www.rbrc.org/> Avertissement: Ne pas utiliser des accumulateurs aux ions de lithium qui sont endommagés ou qui fuient..



## **WARNUNG**

**Um die Gefahr von Bränden oder elektrischen Schlägen zu verringern, darf dieses Gerät nicht Regen oder Feuchtigkeit ausgesetzt werden.**

**Um einen elektrischen Schlag zu vermeiden, darf das Gehäuse nicht geöffnet werden. Überlassen Sie Wartungsarbeiten stets nur qualifiziertem Fachpersonal.**

## **WARNUNG**

Beim Einbau des Geräts ist daher im Festkabel ein leicht zugänglicher Unterbrecher einzufügen, oder der Netzstecker muss mit einer in der Nähe des Geräts befindlichen, leicht zugänglichen Wandsteckdose verbunden werden. Wenn während des Betriebs eine Funktionsstörung auftritt, ist der Unterbrecher zu betätigen bzw. der Netzstecker abzuziehen, damit die Stromversorgung zum Gerät unterbrochen wird.

## **WICHTIG**

Das Namensschild befindet sich auf der Unterseite des Gerätes.

## **WARNUNG**

Zu hoher Schalldruck von Ohrhörern und Kopfhörern kann Gehörschäden verursachen.

Um dieses Produkt sicher zu verwenden, vermeiden Sie längeres Hören bei sehr hohen Schalldruckpegeln.

## **Für Kunden in Europa**

Dieses Produkt besitzt die CE-Kennzeichnung und erfüllt die EMV-Richtlinie der EG-Kommission.

Angewandte Normen:

- EN55103-1: Elektromagnetische Verträglichkeit (Störaussendung)
- EN55103-2: Elektromagnetische Verträglichkeit (Störfestigkeit)

Für die folgenden elektromagnetischen Umgebungen: E1 (Wohnbereich), E2 (kommerzieller und in beschränktem Maße industrieller Bereich), E3 (Stadtgebiet im Freien) und E4 (kontrollierter EMV-Bereich, z.B. Fernsehstudio).

Der Hersteller dieses Produkts ist Sony Corporation, 1-7-1 Konan, Minato-ku, Tokyo, Japan.

Der autorisierte Repräsentant für EMV und Produktsicherheit ist Sony Deutschland GmbH, Hedelfinger Strasse 61, 70327 Stuttgart, Deutschland. Bei jeglichen Angelegenheiten in Bezug auf Kundendienst oder Garantie wenden Sie sich bitte an die in den separaten Kundendienst- oder Garantiedokumenten aufgeführten Anschriften.

## **Für Kunden in Deutschland**

Entsorgungshinweis: Bitte werfen Sie nur entladene Batterien in die Sammelboxen beim Handel oder den Kommunen. Entladen sind Batterien in der Regel dann, wenn das Gerät abschaltet und signalisiert „Batterie leer“ oder nach längerer Gebrauchsdauer der Batterien „nicht mehr einwandfrei funktioniert“. Um sicherzugehen, kleben Sie die Batteriepole z.B. mit einem Klebestreifen ab oder geben Sie die Batterien einzeln in einen Plastikbeutel.

# Table of Contents

---

## Overview

<b>Package Configuration .....</b>	<b>12</b>
<b>Features .....</b>	<b>13</b>
<b>Using the Software .....</b>	<b>16</b>
Reading the CD-ROM Manuals .....	16
System Requirements for Using the Applications .....	16
Software Installation .....	17
<b>Parts Identifications .....</b>	<b>18</b>
Camcorder .....	18
IR Remote Commander (Supplied) .....	22
<b>On-Screen Indications .....</b>	<b>23</b>
Indications in Camera Mode .....	23
Direct Menu Operation .....	24

---

## Preparations

<b>Power Supply .....</b>	<b>26</b>
Using a Battery Pack .....	26
Using AC Power (DC IN Power) .....	27
Turning Power On .....	28
Turning Power Off .....	28
<b>Setting the Clock .....</b>	<b>29</b>
<b>Adjusting the LCD Monitor and Viewfinder .....</b>	<b>30</b>
Adjusting the LCD Monitor .....	30
Adjusting the Viewfinder .....	31
<b>Adjusting the Grip .....</b>	<b>32</b>
<b>Using the IR Remote Commander .....</b>	<b>33</b>
<b>Handling SxS Memory Cards .....</b>	<b>34</b>
About SxS Memory Cards .....	34
Inserting/Removing an SxS Memory Card .....	35
Switching Between SxS Memory Cards .....	36
Formatting an SxS Memory Card .....	36
Checking the Remaining Time Available for Recording .....	37
Restoring an SxS Memory Card .....	37
<b>Using an External Hard Disk .....</b>	<b>38</b>
Attaching/Removing the PHU-60K/120K/120R .....	38

Formatting the PHU-60K/120K/120R .....	39
Checking the Remaining Time Available for Recording .....	40
Restoring the PHU-60K/120K/120R .....	40
<b>Using a Media Adaptor .....</b>	<b>41</b>
Formatting .....	41

---

## Recording

<b>Basic Operation Procedure .....</b>	<b>42</b>
<b>Selecting the Video Format .....</b>	<b>44</b>
Selectable Formats .....	44
Switching between HD and SD .....	45
Changing the Format .....	46
<b>Switching the ND Filters .....</b>	<b>46</b>
<b>Adjusting the White Balance .....</b>	<b>47</b>
Selecting the Adjustment Mode .....	47
Executing Auto White Balance .....	48
<b>Displaying the Markers and Zebra Patterns .....</b>	<b>49</b>
Displaying the Markers .....	49
Displaying the Zebra Patterns .....	50
<b>Setting the Gain .....</b>	<b>51</b>
Recording With Fixed Gain .....	51
Recording in AGC Mode .....	51
<b>Setting the Electronic Shutter .....</b>	<b>52</b>
Shooting in a Fixed Shutter Mode .....	52
Shooting in EX Slow Shutter Mode .....	53
Shooting in Auto Shutter Mode .....	53
<b>Adjusting the Iris .....</b>	<b>54</b>
Recording in Auto Iris Mode .....	54
Adjusting the Iris Manually .....	54
<b>Adjusting the Zoom .....</b>	<b>55</b>
Switching the Zoom Mode .....	55
Operating the Zoom Manually .....	55
Using the Power Zoom .....	55
<b>Adjusting the Focus .....</b>	<b>57</b>
Adjusting in Full MF Mode .....	57
Adjusting in MF Mode .....	58
Adjusting in AF Mode .....	59
Using Macro Mode .....	59
<b>Eliminating Picture Blurring (Steady Shot) .....</b>	<b>60</b>
<b>Reducing Flickers .....</b>	<b>60</b>

<b>Setting the Time Data .....</b>	<b>61</b>
Running Modes of the Timecode .....	61
Setting the Timecode .....	62
Setting the User Bits .....	63
Displaying the Time Data .....	63
<b>Recording Audio Signals .....</b>	<b>64</b>
Using the Built-in Stereo Microphones .....	64
Using External Inputs .....	64
Using an External Microphone .....	64
Adjusting the Audio Recording Levels .....	65
Monitoring the Audio .....	65
<b>Outputting the Color Bars and Reference Tone .....</b>	<b>66</b>
<b>Recording Shot Marks .....</b>	<b>67</b>
<b>Adding the OK Mark .....</b>	<b>67</b>
<b>Rec Review .....</b>	<b>68</b>
<b>Changing Functions of the Assignable Buttons .....</b>	<b>69</b>
<b>Interval Recording .....</b>	<b>70</b>
Preparatory Settings .....	71
Performing Interval Recording .....	71
<b>Frame Recording .....</b>	<b>72</b>
Preparatory Settings .....	72
Performing Frame Recording .....	72
<b>Picture Cache Recording .....</b>	<b>73</b>
Preparatory Settings .....	73
Performing Picture Cache Recording .....	74
<b>Slow &amp; Quick Motion Recording .....</b>	<b>75</b>
Preparatory Settings .....	75
Recording in Slow & Quick Motion Mode .....	76
<b>Freeze Mix: Image Alignment .....</b>	<b>77</b>
<b>Shot Transition .....</b>	<b>78</b>
Preparatory Settings .....	79
Recording with a Shot Transition .....	80
<b>Fader Function .....</b>	<b>82</b>
Preparatory Settings .....	82
Starting Recording with a Fade In .....	83
Ending Recording with a Fade Out .....	83
<b>Picture Profiles .....</b>	<b>84</b>
Registering the Customized Settings as a Picture Profile .....	84
Selecting a Picture Profile .....	84
Copying the Settings of a Picture Profile .....	85
Resetting a Picture Profile .....	85

Storing a Picture Profile on an SxS Memory Card .....	85
Picture Profile Items .....	87
<b>Deleting Clips .....</b>	<b>92</b>
Deleting the Last Recorded Clip .....	92
Deleting Clips Collectively .....	92
<b>Storing/Retrieving the Setting Data .....</b>	<b>93</b>
Storing the Setup File .....	93
Retrieving the Setup File .....	93
Resetting to the Standard Values .....	93

---

## Playback

<b>Thumbnail Screens .....</b>	<b>94</b>
Configuration of the Thumbnail Screen .....	94
Changing the Type of Thumbnail Screen .....	96
<b>Playing Back Clips .....</b>	<b>97</b>
Playing Back the Selected and Subsequent Clips in Sequence .....	97
Monitoring Audio .....	98
Switching to High-Speed Playback .....	98
Cueing Up .....	99
Adding Shot Marks During Playback (HD Mode) .....	99
<b>Clip Operations .....</b>	<b>100</b>
Clip Operation Menus .....	100
Basic Operations of the Clip Operation Menu .....	101
Displaying the Detailed Information of a Clip .....	102
Adding/Deleting the OK Mark to/from a Clip (HD Mode Only) .....	103
Copying Clips .....	103
Deleting Clips .....	104
Displaying the EXPAND CLIP Screen .....	105
Displaying the SHOT MARK Screen (HD Mode Only) .....	106
Adding/Deleting Shot Marks (HD Mode Only) .....	107
Changing the Index Frame (HD Mode Only) .....	108
Dividing a Clip (HD Mode Only) .....	108

---

## Status Displays

<b>Showing the Status Screens .....</b>	<b>109</b>
<b>CAMERA Status Screen .....</b>	<b>110</b>
<b>AUDIO Status Screen .....</b>	<b>111</b>
In Camera Mode .....	111

In Media Mode .....	111
<b>VIDEO Status Screen .....</b>	<b>112</b>
<b>BUTTON/REMOTE Status Screen .....</b>	<b>112</b>
<b>BATTERY/MEDIA Status Screen .....</b>	<b>113</b>

---

## **Menu Configuration and Detailed Settings**

<b>Overview of the Setup Menus .....</b>	<b>114</b>
Setup Menu Configuration .....	114
Setup Menu Layers .....	114
<b>Basic Menu Operations .....</b>	<b>115</b>
<b>Setup Menu List .....</b>	<b>118</b>
CAMERA SET Menu .....	118
AUDIO SET Menu .....	123
VIDEO SET Menu .....	124
LCD/VF SET Menu .....	125
TC/UB SET Menu .....	128
OTHERS Menu .....	129

---

## **Connecting External Devices**

<b>Connecting External Monitors .....</b>	<b>135</b>
<b>Operating Clips With a Computer .....</b>	<b>137</b>
<b>Connecting an External Device (i.LINK Connection) .....</b>	<b>139</b>
Recording the Camcorder Picture on an External Device .....	139
Nonlinear Editing .....	140
Recording External Input Signals .....	140
<b>About i.LINK .....</b>	<b>142</b>

---

## **Appendixes**

<b>Important Notes on Operation .....</b>	<b>143</b>
<b>Formats and Limitations of Outputs .....</b>	<b>145</b>
Video Formats and Output Formats .....	145
Limitations of Outputs .....	150
<b>Backup Battery .....</b>	<b>154</b>
<b>Troubleshooting .....</b>	<b>155</b>
Operating Power .....	155
Recording/Playback .....	155
External Devices .....	156

<b>Error/Warning Indications .....</b>	<b>157</b>
Error Indications .....	157
Warning Indications .....	157
<b>MPEG-2 Video Patent Portfolio License .....</b>	<b>160</b>
<b>Specifications .....</b>	<b>160</b>
General .....	160
Camera Block .....	161
Audio Block .....	162
Displays .....	162
Media Block .....	162
Inputs/Outputs .....	162
Optional Accessories .....	163
<b>Index .....</b>	<b>164</b>

## Overview

# Package Configuration

Make sure you have following items supplied with your camcorder.  
The number in parentheses indicates the number of that item supplied.

### Lens hood with lens cap (1)

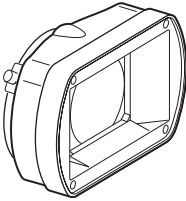

It is attached to the camcorder at the factory.  
If you attach an optional wide-conversion lens,  
remove the lens hood.

### Large eyecup (1)



It is attached to the  
camcorder at the factory.

### Infrared Remote Commander (1)



### USB cable (1)



### AV connecting cable (1)

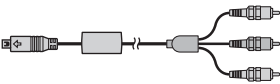

### Component video cable (1)

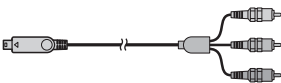

### Cold shoe kit (1)

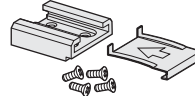

The kit comprises an auxiliary shoe, four screws, and  
a bottom plate.

### BP-U30 battery pack (1)

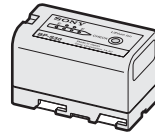

### BC-U1 battery charger (1)

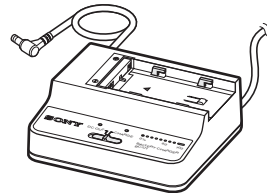

### Shoulder strap (1)

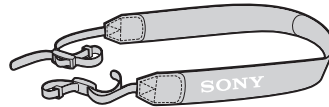

### Lithium battery (CR2032 for backup) (1)

It is mounted in the camcorder at the factory.

### Lithium battery (CR2025 for the IR Remote Commander) (1)

It is mounted in the IR Remote Commander at the  
factory.

### CD-ROM:

Utility Software for Solid-State Memory  
Camcorder and Recorder (XDCAM EX Clip  
Browsing Software, SxS Device Driver  
Software) (1)

## Features

The PMW-EX1R is a highly compact and high-performance XDCAM EX<sup>1)</sup> camcorder that uses SxS<sup>1)</sup> memory cards, as its recording medium. The imaging devices used in the PMW-EX1R camcorder are three 1/2-inch type CMOS sensors, each with an effective pixel count of 1920 × 1080, which produce images in full HD resolution.

---

### Multiple-format recording

---

The PMW-EX1R camcorder offers a wide array of recording formats for multiple content creation applications. In addition to HD video of 1080 or 720 effective scan lines, the camcorder can also record and play back in DVCAM-compatible mode.

Switching between Progressive and Interlace and between NTSC and PAL are also possible, permitting you to use various formats for your needs.

SxS memory cards can simultaneously hold multiple files of any of these recording formats, allowing for flexible use of the memory cards.

---

### A New Generation of HD Recording System

---

#### New nonlinear recording media

Using SxS memory cards, the PMW-EX1R offers nonlinear capabilities such as instant random access and file-based operation.

#### HD recording using the “MPEG-2 Long GOP” codec

The PMW-EX1R records 1920 × 1080 HD images using “MPEG-2 Long GOP” codec compression. This mature “MPEG-2 Long GOP” codec, which is also adopted in the XDCAM<sup>1)</sup> HD and HDV<sup>2)</sup> 1080i series of products, enables you to record stunning-quality HD video and audio with long recording time by efficiently compressing the data.

#### Selectable bit rates

The PMW-EX1R offers a choice of bit rates: either 35 Mbps (HQ mode) or 25 Mbps (SP mode), depending on the desired picture quality and recording time.

### Long recording time

By utilizing an efficient compression format, the PMW-EX1R records high-quality HD images for long recording time of approx. 100 minutes in HQ mode (35 Mbps VBR) or approx. 140 minutes in SP mode (25 Mbps CBR) on a single 32-GB SxS memory card. Equipped with two SxS memory card slots, the PMW-EX1R makes transition seamless without any frame loss, when recording is done across two cards.

### High-quality uncompressed audio recording

In addition to HD video recording, the PMW-EX1R can record and play back high-quality, two-channel 16-bit, 48-kHz linear PCM uncompressed audio.

### IT friendly

The file-based recording in MP4 format allows material to be handled with great flexibility in an IT-based environment, easily available for copying, transferring, sharing, and archiving.

### Instant-access thumbnail display with “Expand” function

Each time a recording is started and stopped on the XDCAM EX camcorder, the video and audio signals are recorded as one clip. Furthermore, thumbnails are automatically generated for each clip as a visual reference, allowing the operator to cue-up to a desired scene simply by guiding the cursor to a thumbnail. For further convenience, the ‘Expand’ function allows one selected clip in the Thumbnail display to be divided into 12 equal time intervals, each with its own thumbnail identifier. This is useful if you wish to quickly search for a particular scene within a lengthy clip.

---

## Cutting-edge Camera Technologies

---

### 1/2-inch type three “Exmor”<sup>1)</sup> CMOS sensors

The PMW-EX1R is equipped with three newly developed 1/2-inch type “Exmor” CMOS Sensors, which deliver excellent picture performance with full HD resolution.

### 14x zoom lens

The PMW-EX1R is equipped with a zoom lens specifically designed for the camcorder to offer optimum picture performance. Independent rings for zoom, focus, and iris adjustment give the user a high level of operational comfort.

### Versatile focus-assistance functions

The lens has a versatile functions for easy and precise focus adjustments.

- One-push Auto Focus
- MF Assist
- Expanded Focus
- Peaking
- Optical Image Stabilizer (Steady Shot)

---

## Creative Recording Modes and Settings

---

### 23.98P native recording

The PMW-EX1R camcorder, a new member of Sony’s legendary CineAlta<sup>1)</sup> family, though compact offers native 23.98P recording capability.

### Slow & Quick Motion function

The PMW-EX1R offers a Slow & Quick Motion function, commonly known as overcranking and undercranking in film shooting, which enables you to create unique ‘looks’ or special effects of slow- and fast-motion images.

### Slow Shutter function

The PMW-EX1R offers a Slow Shutter function for capturing clear images in low-light environments. This allows the shutter speed to be changed to a maximum of 64-frame accumulation period.

### Selectable gamma curves

The PMW-EX1R provides various types of gamma identical to those of other CineAlta camcorders.

### Interval Recording function

The PMW-EX1R offers an Interval Recording function that intermittently records signals at pre-determined intervals. This is convenient for shooting over long periods of time and also when creating pictures with special effects of extremely quick motion.

### Frame Recording function

Frame Recording is a unique feature of the PMW-EX1R camcorder that is especially useful for clay-animation shooting. With this function, images for pre-determined frame are recorded each time the record button is pressed.

### Shutter-angle settings

In addition to the electric shutter speed controls, the PMW-EX1R also has a “shutter angle” control, which is familiar to cinematographers.

### Picture Profile feature

The Picture Profile feature allows the camera operator to easily call up customized picture-tonal settings to suit particular shooting conditions.

### Shot Transition function

The Shot Transition function allows for smooth automatic scene transitions. The operator can program start and end settings for zoom, focus, and white balance into the A and B buttons, and with a press of the Start button a smooth transition will take place according to the set time.

### Picture Cache function

The unit can utilize its internal memory to store the image being captured, allowing recording to commence a certain time (15 seconds at maximum) in advance of when the recording button is pressed.

---

## A variety of functions and designs for high operability

---

- Depth-of-field indicator
- Brightness-level display
- Histogram indicator
- 3.5-inch color LCD monitor
- Easy-to-see color viewfinder
- Rotary grip
- Four assignable buttons
- Zoom and recording start/stop operations enabled both on the handle and the grip
- Long operating time with a battery pack
- Wide array of interfaces, including USB, i.LINK<sup>1)</sup>, and HDMI<sup>3)</sup>
- ATW (Auto Tracing White Balance)
- Built-in ND filter wheel
- Selectable gain
- High-speed picture search: ×4, ×15, ×24
- Freeze Mix function
- Image Inversion function
- IR Remote Commander<sup>1)</sup> supplied

1) Sony, XDCAM, XDCAM EX, SxS, i.LINK, Exmor, CineAlta, and Remote Commander are trademarks of Sony Corporation.

2) HDV is a trademark of Sony Corporation and Victor Company of Japan, Limited.

3) HDMI, HDMI logo and High-Definition Multimedia Interface are trademarks or registered trademarks of HDMI Licensing, LLC in the United States and other countries.

All other trademarks are the property of their respective owners.

---

## XDCAM EX web sites

---

For information on XDCAM EX, visit the following web sites:

### United States

<http://www.sony.com/xdcamex>

### Canada

<http://www.sony.ca/xdcamex>

### Europe, Middle East, Africa, and Russia

<http://www.sonybiz.net/xdcamex>

### Latin America

<http://www.sonypro-latin.com/xdcamex>

### Australia

[www.sony.com.au/xdcamex](http://www.sony.com.au/xdcamex)

### Asia (except Korea, China, and Japan)

<http://pro.sony-asia.com>

### Korea

<http://bp.sony.co.kr/xdcamex>

### China

<http://pro.sony.com.cn/minisite/XDCAMEX>

### Japan

<http://www.sony.co.jp/XDCAMEX>

## Using the Software

The CD-ROM labelled “Utility Software for Solid-State Memory Camcorder and Recorder” contains the following software:

### SxS Device Driver Software

Driver for using SxS memory cards with a computer having an ExpressCard slot. Information on installation of the software is included in the ReadMe (Japanese, English, French, German, Italian, Spanish, and Chinese) in PDF format.

### XDCAM EX Clip Browsing Software

Application program for operating clips recorded with XDCAM EX-series models on a computer. Information on installation and operations of the software is included in the User’s Guide (Japanese, English, French, German, Italian, Spanish, and Chinese) in PDF format.

## Reading the CD-ROM Manuals

### Preparations

The following program must be installed on your computer in order to read the operation manuals contained on the CD-ROM.

Adobe Reader Version 6.0 or higher

#### Memo

If Adobe Reader is not installed, you can download it from the following URL:  
<http://www.adobe.com/>

Adobe and Adobe Reader are trademarks of Adobe Systems Incorporated in the United States and/or other countries.

### To read the documents

Do the following:

#### 1 Insert the CD-ROM in your CD-ROM drive.

A cover page appears automatically in your browser.

If it does not appear automatically in the browser, double-click on the index.htm file on the CD-ROM.

#### 2 Select and click on the manual that you wish to read.

This opens the PDF file.

#### Memo

The files may not be displayed properly, depending on the version of Adobe Reader. In such a case, install the latest version you can download from the URL mentioned in “Preparations” above.

#### Note

If you have lost or damaged the CD-ROM, you can purchase a new one to replace it. Contact your Sony service representative.

## System Requirements for Using the Applications

### SxS Device Driver Software

#### Applicable hardware

Computer conforming to ExpressCard/34 or ExpressCard/54

#### OS

Microsoft Windows XP SP2 or later, Windows Vista, or Windows 7  
Mac OS X v10.4.9 or later, v10.5.0 or later, v10.6.0 or later

For other Operating Systems and support information on the driver, refer to the following URL:

<http://www.sony.net/SxS-Support/>

- Microsoft, Windows, Windows Vista, and Windows 7 are registered trademarks and/or trademarks of Microsoft Corporation in the United States and/or other countries.
- Macintosh and Mac OS are trademarks of Apple Inc. registered in the U.S States and other countries.

### XDCAM EX Clip Browsing Software

For the operating requirements, visit the web sites shown in “XDCAM EX web sites” (page 15) or refer to the User’s Guide contained in the CD-ROM.

## Software Installation

Do the following to install the software on the CD-ROM on your computer:

### 1 Insert the CD-ROM in your CD-ROM drive.

A cover page appears automatically in your browser.

If it does not appear automatically in the browser, double-click on the index.htm file on the CD-ROM.

### 2 Select and click on the software that you wish to install.

The installer for the software starts up.

Follow the displayed instructions:

*For details, refer to the User's Guide or ReadMe of the software.*

---

## Uninstalling an application program

---

### Windows computer

Choose "Start," "Control Panel" then "Add or Remove Programs" and specify the program to be deleted.

### Macintosh computer

Drop the folder of the software (default: /Application/XDCAM EX Clip Browser) into Trash.

# Parts Identifications

For functions and usage, see the pages shown in parentheses.

## Camcorder

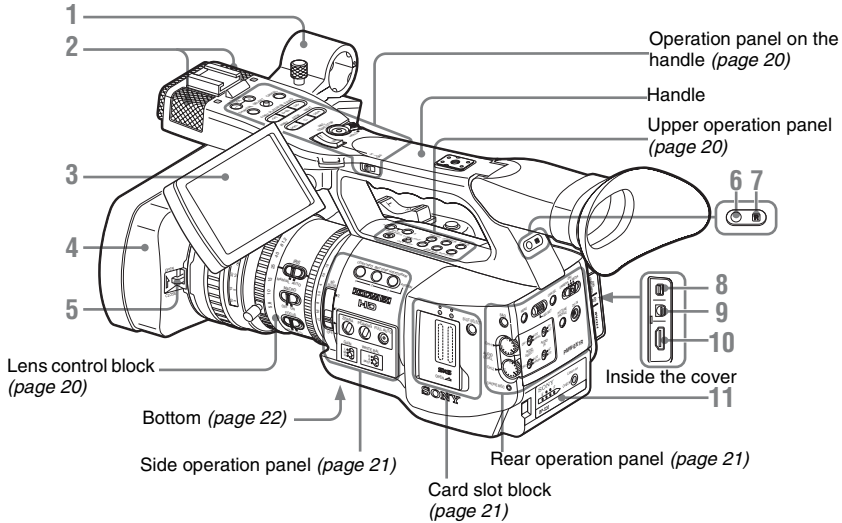

1. External microphone holder (page 64)
2. Built-in microphone (page 64)
3. LCD (Liquid Crystal Display) monitor (page 30)
4. Lens hood  
If you attach an optional wide-conversion lens, remove the lens hood. (See the column at right.)
5. Lens cap open/close lever (page 42)
6. Rear tally lamp (page 43, page 157)
7. Rear IR remote control receptor
8. COMPONENT OUT connector (Mini D) (page 136)
9. A/V OUT connector (audio/video multi output) (page 136)
10. HDMI OUT connector (page 136)
11. Battery pack receptacle (page 26)

### To remove the lens hood

- ① Loosen the hood fixing screw, ② turn the hood in the direction of the arrow, ③ then pull it out.

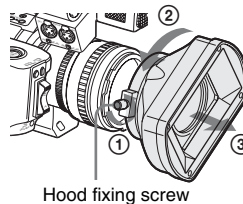

- To reattach the hood**, align the marks on the hood with those on the camcorder, turn it in the opposite direction from that when you removed it, then tighten the fixing screw.

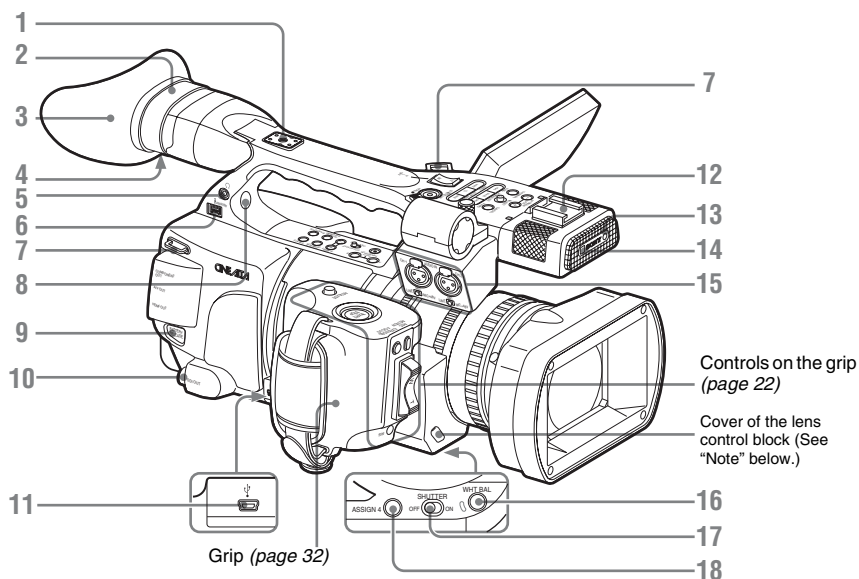

1. **Rear accessory shoe**  
The supplied cold shoe kit can be attached (page 38).
2. **Viewfinder** (page 31)
3. **Eyecup** (page 31)
4. **Eyepiece focusing knob** (page 31)
5. **Headphone jack** (stereo mini jack) (page 65, page 98)
6. **i.LINK (HDV/DV) connector** (4-pin, S400 conforming to IEEE1394) (page 139)
7. **Hooks for the shoulder strap** (left and right)  
Attach the supplied shoulder strap as shown below.
8. **Built-in speaker** (page 65, page 98)
9. **BATTERY RELEASE** button (page 26)
10. **SDI OUT connector** (BNC type) (page 135)
11. **USB connector (Mini B)** (page 137)
12. **Front accessory shoe**
13. **REC/TALLY lamp** (page 43, page 157)
14. **Front IR remote control receptor**
15. **AUDIO IN CH-1/CH-2 connectors (XLR) and input selection switches** (page 64)
16. **WHT BAL** (automatic white balance adjustment) button (page 47)
17. **SHUTTER** switch (page 52)
18. **ASSIGN 4** (assignable 4) button (page 69)

**Note**

The lens is properly adjusted at the factory. Do not touch the controls of the lens control block.

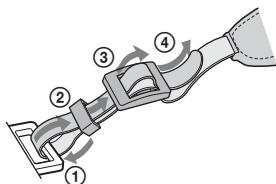

8. **Built-in speaker** (page 65, page 98)
9. **BATTERY RELEASE** button (page 26)
10. **SDI OUT connector** (BNC type) (page 135)

## Operation panel on the handle

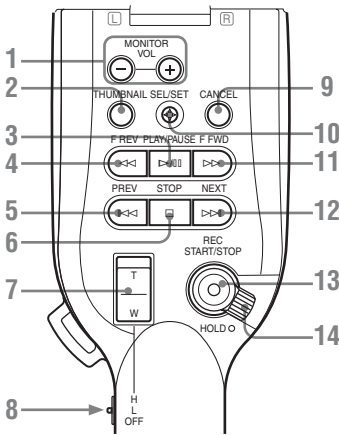

1. MONITOR VOL (volume) buttons (page 65, page 98)
2. THUMBNAIL button (page 96)
3. PLAY/PAUSE button (page 97)
4. F REV (fast reverse) button (page 97)
5. PREV (previous) button (page 97)
6. STOP button (page 100)
7. On-handle ZOOM button (page 55)
8. Zoom speed switch (page 55)
9. CANCEL button (page 115)
10. SEL/SET (selection/set) button (Joystick) (page 115)  
It functions accordingly when you move it up (toward the subject), down (toward the viewfinder), left, or right, or you push along the axis.  
It is called “the joystick” in the subsequent operating instructions.
11. F FWD (fast forward) button (page 97)
12. NEXT button (page 97)
13. REC START/STOP button (page 42)
14. REC HOLD lever (page 43)

## Upper operation panel

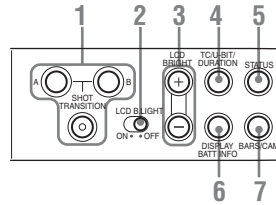

1. SHOT TRANSITION operation block (page 78)
2. LCD B.LIGHT (LCD backlight) switch (page 30)
3. LCD BRIGHT +/- (LCD brightness adjustment) buttons (page 30)
4. TC/U-BIT/DURATION (time data selection) button (page 63, page 97)
5. STATUS button (page 109)
6. DISPLAY/BATT INFO button (page 23, page 27)
7. BARS/CAM (color bar/camera signal switching) button (page 66)

## Lens control block

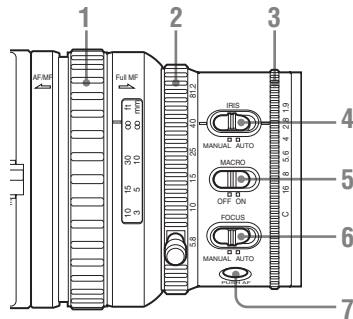

1. Focus ring (page 57)
2. Zoom ring (page 55)
3. Iris ring (page 54)
4. IRIS switch (page 54)
5. MACRO switch (page 59)
6. FOCUS switch (page 58)

**7. PUSH AF (momentary auto focus) button**  
(page 58)

**Side operation panel**

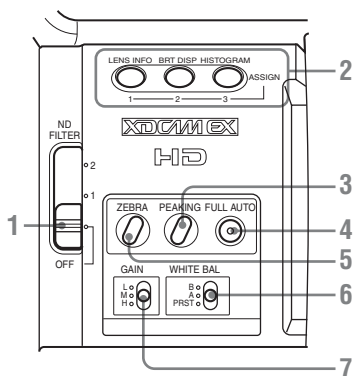

1. ND filter select switch (page 46)
2. ASSIGN (assignable)1/2/3 buttons (page 69)
3. PEAKING button (page 58)
4. FULL AUTO button and indicator (page 42)
5. ZEBRA button (page 50)
6. WHITE BAL (white balance memory) switch (page 47)
7. GAIN switch (page 51)

**Card slot block**

The SxS memory card slots and EJECT buttons are located behind the cover.

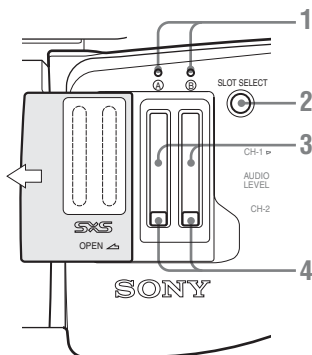

1. ACCESS lamps (page 35)
2. SLOT SELECT (SxS memory card select) button (page 36)
3. SxS memory card slots (page 35)
4. EJECT buttons (page 36)

**Rear operation panel**

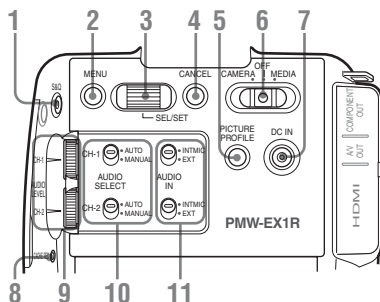

1. S&Q (Slow & Quick Motion) button (page 75)
2. MENU (menu display ON/OFF) button (page 115)
3. SEL/SET (selection/set) dial (Jog dial) (page 115)  
It functions accordingly when you turn it up or down, or you push it horizontally. It is called “the jog dial” in the subsequent operating instructions.
4. CANCEL button (page 115)
5. PICTURE PROFILE button (page 84)
6. Power (CAMERA/MEDIA) switch (page 28)
7. DC IN (DC power input) connector (page 27)
8. CACHE REC lamp (page 73)
9. AUDIO LEVEL CH-1 /CH-2 controls (page 64)
10. AUDIO SELECT (audio level control mode selection) switches (page 64)
11. AUDIO IN (audio input selection) switches (page 64)

## Controls on the grip

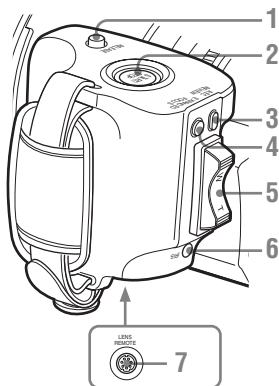

1. **RELEASE (grip release) button** (page 32)
2. **REC START/STOP button** (page 42)
3. **REC REVIEW button** (page 68)
4. **EXPANDED FOCUS button** (page 57)
5. **Servo zoom lever** (page 55)
6. **IRIS button** (page 54)
7. **LENS REMOTE connector** (page 56)

## Bottom

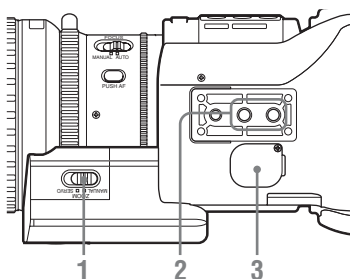

1. **ZOOM switch** (page 55)
2. **Tripod receptacles**

### Note

Check that the size of the hole matches the screw of the tripod. If they do not match, the camcorder cannot be attached to the tripod securely.

3. **Backup battery holder** (page 154)

## IR Remote Commander (Supplied)

The buttons without remarks can be used in the same manner as the corresponding buttons on the camcorder.

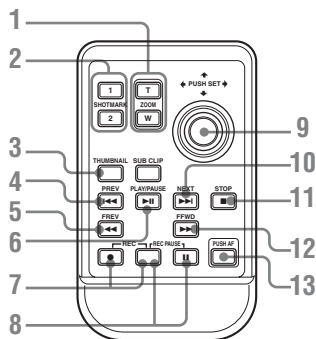

1. **ZOOM T/W (telephoto/wide-angle) button**
2. **SHOTMARK 1 and 2 buttons** (page 67, page 107)
3. **THUMBNAIL button**
4. **PREV (previous clip jump) button**
5. **F REV (fast reverse) button**
6. **PLAY/PAUSE button**
7. **REC (record) buttons**  
Press the ● button together with the unmarked button (safety button) to start recording.
8. **REC PAUSE buttons**  
Press the ■ button together with the unmarked button (safety button) to pause recording.
9. **PUSH SET button (four-way arrow key)**  
It functions the same as the SEL/SET button (joystick) on the camcorder.
10. **NEXT button**
11. **STOP button**
12. **F FWD (fast forward) button**
13. **PUSH AF button**

### Note

The SUB CLIP button does not function with this camcorder.

When you use the remote commander, see "Using the IR Remote Commander" on page 33.

# On-Screen Indications

## Indications in Camera Mode

When this unit is in Camera mode (mode for recording), pressing the DISPLAY/BATT INFO button displays the statuses and settings of this unit on the LCD monitor/viewfinder screen. When you press the DISPLAY/BATT INFO button again, these indications are canceled. The recording status indication, such as “●REC,” is always displayed, regardless of operation of the DISPLAY/BATT INFO button.

### Remarks

- [M]: The indication of the items named with this suffix can be independently turned on/off with “Display On/Off” of the LCD/VF SET menu (see page 127).
- [A]: The indication of items named with this suffix can be turned on/off using the assignable buttons to which the corresponding on/off functions have been assigned (see page 69).
- [D]: The settings of the items named with this suffix can be changed using the Direct menu on the screen (see page 24).

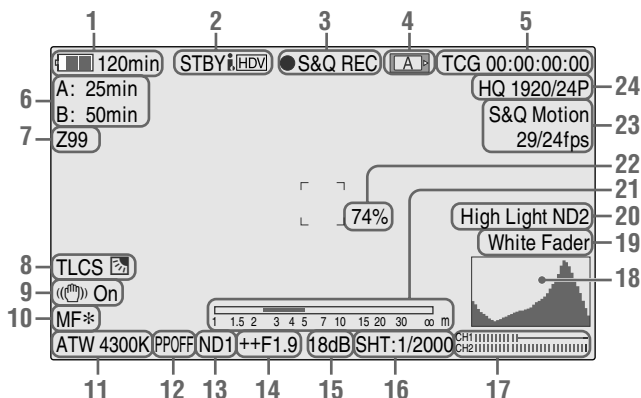

### 1. Battery remaining/DC IN voltage indication [M] (page 27)

### 2. i.LINK status indication (page 139)



Only when an external device is connected to the i.LINK connector, the status of the device is displayed.

### 3. Special recording/operation status indication

●REC	Recording in progress
STBY	Standby for recording
●S&Q REC	Slow & Quick Motion recording in progress

S&Q STBY	Standby for Slow & Quick Motion recording
●INT REC	Interval Recording in progress
INT STBY	Standby for Interval Recording
●FRM REC	Frame Recording in progress
FRM STBY	Standby for Frame Recording
●CACHE	● in green: Standby for Cache Recording ● in red: Cache Recording in progress

#### 4. Media status indication



	Memory card in slot A is active.
	Memory card in slot B is active.

#### 5. Time data indication [M] (page 63)

#### 6. Media remaining indication [M] (page 37)

#### 7. Zoom position indication [M] (page 55)

#### 8. TLCS mode indication [M] [D] (page 121)

	Backlight mode
	Standard mode
	Spotlight mode

#### 9. Steady Shot indication [M] [D] (page 60)

#### 10. Focus mode indication [M] ([D] only in MF mode) (page 57)

#### 11. White balance mode and color temperature indications [M] [D] (page 47)

#### 12. Picture profile indication [M] [D] (page 84)

#### 13. ND filter indication [M] (page 46)

#### 14. Iris position indication [M] [D] (page 54)

#### 15. Gain indication [M] [D] (page 51)

#### 16. Shutter mode/shutter speed indication [M] [D] (page 52)

#### 17. Audio level meters [M] (page 65)

#### 18. Histogram indication [M] [A]

#### 19. Fader indication [M] (page 82)

#### 20. Video level cautioning indication [M]

If the video level is too high or too low, a caution is generated showing the appropriate ND filter number.

#### 21. Depth-of-Field indication [M] [A]

#### 22. Brightness level indication [M] [A]

#### 23. Special recording mode indication [M] ([D] only in Slow & Quick Motion Standby)

Frame Rec	Frame Rec mode
Interval Rec	Interval Rec mode
S&Q Motion xx/xx fps	Slow & Quick Motion mode

#### 24. Video Format indication [M] (page 44)

## Direct Menu Operation

The settings of the items named with a suffix [D] can be changed using the Direct menu on the screen.

Select “All,” “Part,” or “Off” for Direct Menu using “Direct Menu” (page 131) of the OTHERS menu.

When the Direct mode is set to “Part,” the operation is limited depending on the GAIN, SHUTTER, or WHITE BAL switch setting. When the Direct mode is set to “All,” the GAIN, SHUTTER, and WHITE BAL switches are disabled.

### Note

When the indicator of the FULL AUTO button is lit, the Direct Menu operation is disabled for the functions that are forcibly set to the automatic mode in Full Auto mode (page 42).

### To operate the Direct menu

Use the joystick on the handle or the jog dial on the rear control panel.

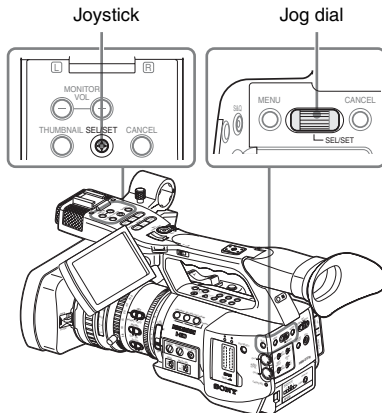

#### 1 Press the joystick or the jog dial.

If “Direct Menu” is set to “All” or “Part,” the cursor is displayed on one of the items for which the Direct menu operation is permitted.

**Example:** TLCS mode indication

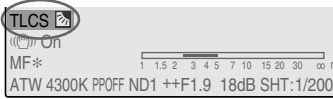

- 2 Tilt the joystick or rotate the jog dial to set the cursor to the item to be operated then press the joystick or the jog dial.**

The Direct menu of the selected items appears.

**Example:**

Direct menu for TLCS mode selection

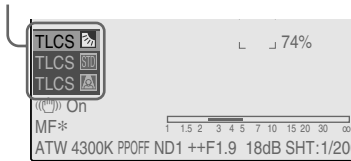

- 3 Tilt the joystick or rotate the jog dial to select the setting then press the joystick or the jog dial.**

The menu disappears, and the new setting is displayed.

## Preparations

# Power Supply

You can use a battery pack or AC power via an AC adaptor.

If you connect an AC power source, it has a priority even if a battery pack is mounted.

For safety, use only the Sony battery packs and AC adaptor listed below:

- BP-U30/U60 Lithium-ion Battery Pack
- BC-U1/U2 Battery Charger (usable as an AC adaptor)

## Using a Battery Pack

Mount a BP-U30 or BP-U60 Lithium-ion battery pack.

One BP-U30 is supplied with this camcorder.

### WARNING

Batteries shall not be exposed to excessive heat such as sunshine, fire or the like.

### AVERTISSEMENT

N'exposez pas les batteries à une chaleur excessive, au soleil ou près d'un feu par exemple.

### WARNUNG

Akkus dürfen keinesfalls übermäßiger Wärmeeinwirkung ausgesetzt werden, wie z.B. Sonneneinstrahlung, Feuer o. ä.

### Notes

- Before use, charge the battery pack with the supplied BC-U1/U2 Battery Charger.
- A warm battery pack immediately after use may not be able to be fully recharged.

## Mounting the battery pack

Fully insert the battery pack then slide it to the left to lock.

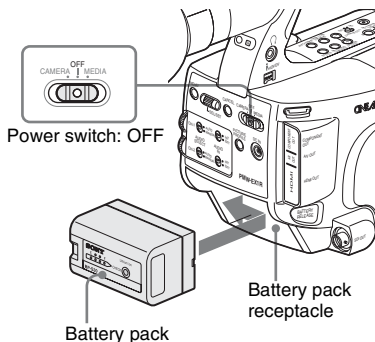

### Note

If a battery pack that cannot be used with this camcorder is mounted, an error message is appears on the LCD monitor/EVF screen. Replace the battery pack with the BP-U30 or BP-U60, or connect a power to the DC IN connector after removing the battery pack.

## Removing the battery pack

Hold the BATTERY RELEASE button pressed, slide the battery pack to the right to unlock, then pull it out.

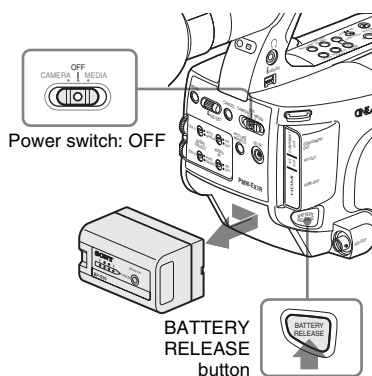

## Checking battery charge remaining

### To check during operation

When recording or playback is in progress on the battery pack, an icon to show the current battery charge level and usage time remaining are displayed on the LCD monitor/EVF screen.

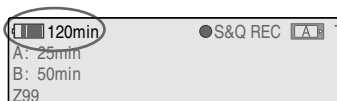

Icon	Remaining
	100% to 91%
	90% to 71%
	70% to 51%
	50% to 31%
	30% to 11%
	10% to 0%

The camcorder indicates the remaining usage time in minutes by calculating the available time with the battery pack if operation is continued at the current rate of power consumption.

#### Note

The operating time on a battery pack depends on the condition (new or old) of the battery pack and the ambient temperature.

### To check in power-off status

Information on the mounted battery pack (BATTERY INFO) is displayed on the LCD monitor screen when you hold the DISPLAY/BATT INFO button pressed even if the camcorder is off.

The BATTERY INFO display goes off after 5 seconds.

### DISPLAY/BATT INFO button

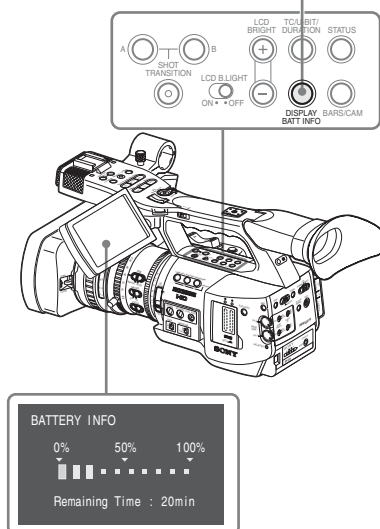

## If the battery charge remaining becomes low

If the battery charge remaining decreases to a certain level during operation (Low BATT status), a low-battery message, flashing of the tally lamps, and a beep sound will warn you. If the remaining further decreases to a level at which operation cannot be continued (BATT Empty status), a battery-empty message appears. Temporarily set the power switch to OFF and connect a power source via the DC IN connector or replace the battery pack with one that is fully charged.

### To change the message levels

The Low BATT level is set to 10% of full charge, and the BATT Empty level is set to 3% of full charge at the factory. These settings can be changed with "Battery Alarm" (page 131) of the OTHERS menu.

## Using AC Power (DC IN Power)

You can connect an AC power source to this camcorder by using the supplied BC-U1 or an optional BC-U2 Battery Charger for BP-U30/U60 as an AC adaptor, as shown below:

Connection example: BC-U1

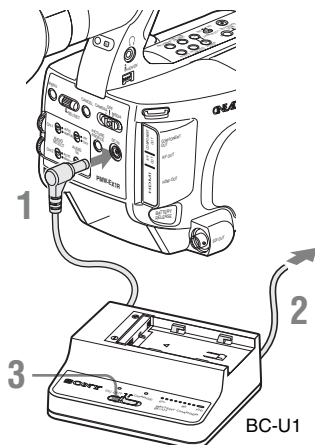

- 1** Connect the DC power output cable of the BC-U1/U2 to the DC IN connector of the camcorder.
- 2** Connect the power cord supplied with the BC-U1/U2 to the AC input connector of the BC-U1/U2 then to an AC power source.
- 3** Set the mode switch of the BC-U1/U2 to the DC OUT position.

For details, refer to the *Operating Instructions of the BC-U1/U2*.

When recording or playback is in progress on power from the DC IN connector, the input voltage is displayed on the LCD monitor/viewfinder screen.

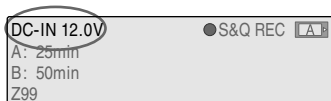

#### Note

The battery pack mounted on the camcorder is not charged even if you set the mode switch of the BC-U1/U2 to the CHARGE position. To charge the battery pack, remove it from the camcorder and mount it on the BC-U1/U2.

## Turning Power On

This camcorder has Camera mode for recording and Media mode for playback. The mode is selected when you turn the power on.

Power switch

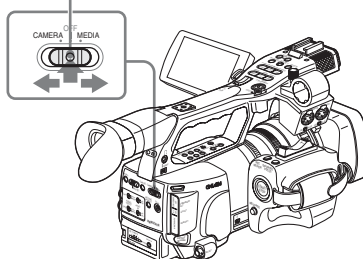

Press the center green button to unlock the power switch and move it from the OFF position to the CAMERA or MEDIA side.

To operate in Camera mode, turn the power on by setting the power switch to the CAMERA position.

To operate in Media mode, turn the power on by setting the power switch to the MEDIA position.

## Turning Power Off

Set the power switch to the OFF position. (It is not necessary to press the center button when returning the switch to the OFF position from the CAMERA or MEDIA side.)

#### Notes

- This camcorder uses a little standby power even when the power switch is set to OFF. Remove the battery pack if the camcorder will not be used for a prolonged period.
- When removing the battery pack or the DC IN power, be sure to set the switch to OFF in advance.

Removing the battery pack and the DC IN power without first setting the power switch to OFF may cause damage to the camcorder or SxS memory cards.

## Setting the Clock

When you turn the camcorder on for the first time after purchasing or replacing the backup battery (page 154), the Initial Setting display appears on the LCD monitor/viewfinder screen.

Set the date and time of the built-in clock, using this display.

```
INITIAL SETTING
Time Zone: UTC +09:00 TOKYO
Date/Time: 2009/01/01 00:00:00 SET
Finish
```

### Time Zone

The value shows the time difference from UTC (Coordinated Universal Time).

Change the setting if needed.

### Setting the time and date

Use the joystick on the handle or jog dial on the rear operation panel for setting.

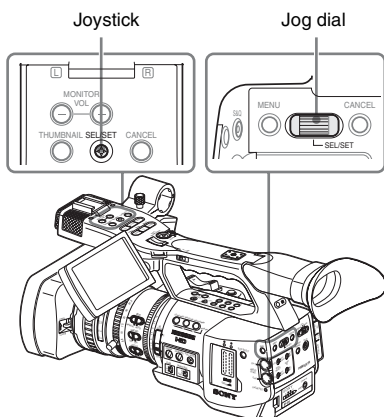

- 1 Tilt the joystick or turn the jog dial to set the cursor to “Date/Time” then press the joystick or dial.**

The cursor moves to the year-setting column.

### INITIAL SETTING

```
Time Zone: UTC +09:00 TOKYO
Date/Time: 2009/01/01 00:00:00 SET
Finish
```

- 2 Tilt the joystick or turn the jog dial to set the year then press the joystick or dial.**

The cursor moves to the month-setting column.

- 3 Set the month, day, hour, minute, and second in sequence in the same manner.**

When you press the joystick or jog dial at “SET,” the cursor moves back to “Date/Time.”

- 4 Move the cursor to “Finish” then press the joystick or dial.**

The Initial Setting display disappears, and the clock setting is completed.

The camcorder enters the operation mode (Camera mode or Media mode) you selected with the power switch.

Once after the Initial Setting display disappears, the time zone and date/time settings can be changed using “Time Zone” (page 129) and “Clock Set” (page 129) of the OTHERS menu.

### Notes

- If the clock setting is cleared because of exhaustion of the backup battery while no operation power was being supplied (no battery pack and no DC IN connection), the Initial Setting display will be displayed when you turn the camcorder on at the next opportunity.
- While the Initial Setting display is shown, no other operation except turning the power off is permitted until you finish the setting for this display.

## Adjusting the LCD Monitor and Viewfinder

### Adjusting the LCD Monitor

You can adjust the angle and the display conditions of the LCD monitor for the best view in various shooting situations. These adjustments of the LCD monitor have no effect on pictures being recorded.

#### Turning on/off the LCD monitor

The LCD monitor turns on when it is opened and turns off when it is returned to the park position. To open, pull the monitor out horizontally from the park position to rotate it 90 degrees.

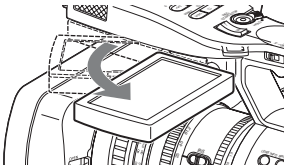

#### Adjusting the angle

Rotate the opened LCD monitor to the desired angle.

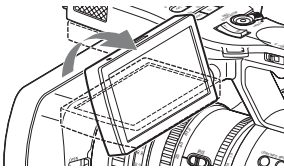

It can be rotated as much as 90 degrees in the direction facing the subject and as much as 180 degrees in the opposite direction.

When you rotate it 90 degrees toward the subject, the image on the monitor becomes upside down, indicating the mirror image of the subject. The display direction of the textual information is converted to the readable direction.

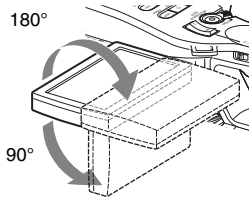

### Adjusting the backlight

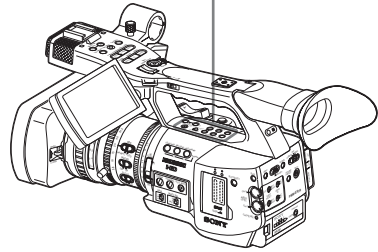
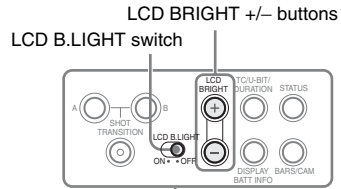

#### Turning the backlight on/off

The backlight may not be necessary for viewing images on the LCD monitor under bright ambient light, such as in an outdoor location. Set the LCD B.LIGHT switch to OFF to turn off the backlight.

#### Adjusting the brightness of the backlight

When you set the LCD B.LIGHT switch to ON, you can adjust the brightness of the backlight, using the LCD BRIGHT + and – buttons. Press the – button to darken the backlight. Press the + button to make it brighter. During adjustment, the backlight level bar appears to indicate the adjustment value.

#### Adjusting the color, contrast, and brightness

These adjustments can be made using the LCD/VF SET menu.

Press the MENU button to set the camcorder to Menu mode and select  (LCD/VF SET menu) then “LCD” from the menu.



Set color, contrast and brightness of the LCD monitor with the corresponding LCD menu items: Color, Contrast, and Brightness

For details on menu operations, see “Basic Menu Operations” on page 115.

## Adjusting the Viewfinder

If the picture on the LCD monitor is hard to view under bright ambient light, you can use the viewfinder to check the picture.

You can adjust the display conditions of the viewfinder according to your current lighting conditions.

These adjustments of the viewfinder have no effect on pictures being recorded.

### Caution

Do not leave the camcorder with the eyepiece of the viewfinder facing the sun. Direct sunlight can enter through the eyepiece, be focused in the viewfinder, and cause fire.

Hereafter the viewfinder is referred to as “EVF” (abbreviation of Electronic Viewfinder).

### Turning the EVF on/off

With the factory setting, the EVF is turned on when the LCD monitor is in its park position or is rotated to face the subject.

You can change the setting so that the EVF is always on regardless of the status of the LCD monitor, using “EVF” (page 125) of the LCD/VF SET menu. Change the “Power” setting from “Auto” to “On.”

### Adjusting the focus in the viewfinder

The eyepiece focusing (diopter compensation) knob enables adjustment to match the eyesight of operator so that the operator can view the image clearly in the eyepiece.

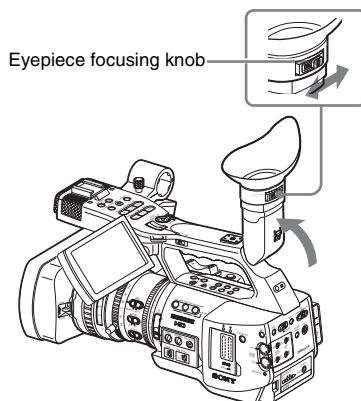

### Adjusting the backlight

The brightness of the backlight for the EVF can be switched between High and Low.

Select “EVF” from the LCD/VF SET menu and set “Backlight.”

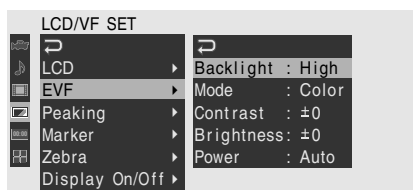

### Switching between color and monochrome modes

For the EVF screen, color or monochrome display can be selected.

Select “EVF” from the LCD/VF SET menu then select “Mode.”

Select “B&W” if checking the subject and focusing are easier on the monochrome display.

If you assign “EVF Mode” to one of the assignable buttons (see page 69), you can switch between color and monochrome by pressing the button.

### Adjusting the contrast and brightness

Select “EVF” from the LCD/VF SET menu and adjust the contrast and brightness with the corresponding items: Contrast and Brightness

For details on menu operations, see “Basic Menu Operations” on page 115.

## Using the eyecup (supplied)

A large eyecup is attached to the EVF at the factory. It can be removed by pulling it out, if not necessary.

To reattach the eyecup, stretch it a little to attach to the EVF and fit the rim of the eyecup into the horizontal groove of the viewfinder.

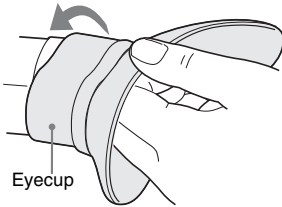

## Adjusting the Grip

The grip rotates approx. 120 degrees to support a variety of shooting styles.

Holding the RELEASE button pressed, slowly rotate the grip.

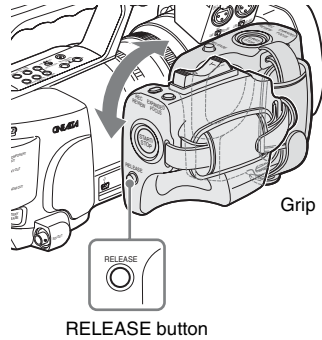

Click positions are provided at each 15 degrees. Release the RELEASE button at the desired click position to lock the grip.

# Using the IR Remote Commander

## Before use

Before you use the supplied IR Remote Commander for the first time, pull out the insulation sheet from the battery holder.

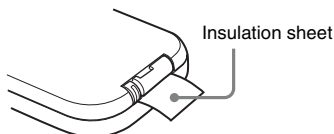

A CR2025 lithium battery is set in the holder at the factory.

## To use the IR Remote Commander

For controlling the camcorder from the IR Remote Commander, activate the remote control function of the camcorder after turning the power on.

Activating/deactivating the remote control function can be achieved using the Setup menu or an assignable button.

### To activate using the menu

Press the MENU button to set the camcorder to Menu mode, select  (the OTHERS menu) and set "IR Remote" to "On."

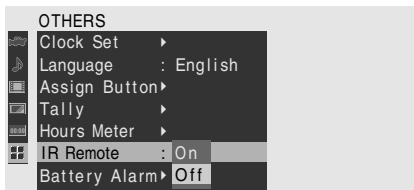

For details on menu operations, see "Basic Menu Operations" on page 115.

### To activate using an assignable button

Assigning "IR Remote" to one of the assignable buttons permits you to activate/deactivate the remote control function by pressing the button.

For the assignable buttons, see "Changing Functions of the Assignable Buttons" on page 69.

## Note

To avoid malfunctions, the remote control function is automatically deactivated when the camcorder is turned off. Activate the function each time when required after you turn the camcorder on.

## Battery lifetime

When the lithium battery's power falls, the IR Remote Commander may not work even if you press the buttons. The average lithium battery's service life is about one year, but this depends on the pattern of use.

If pressing the remote control buttons produces absolutely no effect on the camcorder, replace the battery then check the operation again.

## Replacing the battery in the IR Remote Commander

Use a commercially available CR2025 lithium battery. Do not use any battery other than a CR2025.

- 1 Hold down the lock lever ①, pull out the battery holder ②, and remove the battery.

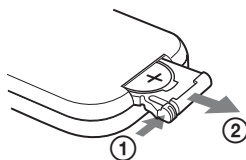

- 2 Place a new battery in the battery holder with the + symbol facing upward ①, then push the battery holder into the IR Remote Commander until it clicks ②.

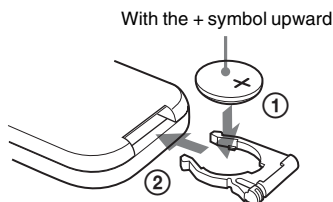

**WARNING**

- Battery may explode if mistreated. Do not recharge, disassemble, or dispose of in fire.
- Batteries shall not be exposed to excessive heat such as sunshine, fire or the like.

**CAUTION**

Danger of explosion if battery is incorrectly replaced. Replace only with the same or equivalent type recommended by the manufacturer.

When you dispose of the battery, you must obey the law in the relative area or country.

**AVERTISSEMENT**

N'exposez pas les batteries à une chaleur excessive, au soleil ou près d'un feu par exemple.

**ATTENTION**

Il y a danger d'explosion s'il y a remplacement incorrect de la batterie. Remplacer uniquement avec une batterie du même type ou d'un type équivalent recommandé par le constructeur.

Lorsque vous mettez la batterie au rebut, vous devez respecter la législation en vigueur dans le pays ou la région où vous vous trouvez.

**WARNUNG**

Akkus dürfen keinesfalls übermäßiger Wärmeeinwirkung ausgesetzt werden, wie z.B. Sonneneinstrahlung, Feuer o. ä.

**VORSICHT**

Explosionsgefahr bei Verwendung falscher Batterien. Batterien nur durch den vom Hersteller empfohlenen oder einen gleichwertigen Typ ersetzen.

Wenn Sie die Batterie entsorgen, müssen Sie die Gesetze der jeweiligen Region und des jeweiligen Landes befolgen.

## Handling SxS Memory Cards

This camcorder records audio and video on SxS memory cards (optional) inserted in the card slots.

### About SxS Memory Cards

#### Usable SxS memory cards

Use the following Sony-made SxS memory cards (SxS PRO or SxS-1) with this camcorder.

Operations are not guaranteed with memory cards other than SxS PRO and SxS-1.

**SxS PRO**

- SBP-8 (8GB)
- SBP-16 (16GB)
- SBP-32 (32GB)

**SxS-1**

- SBS-32G1 (32GB)

These cards comply with the ExpressCard standard.

- SxS, SxS PRO and SxS-1 are trademarks of Sony Corporation.
- The ExpressCard word mark and logo are owned by Personal Computer Memory Card International Association (PCMCIA) and are licensed to Sony Corporation. All other trademarks are the property of their respective owners.

#### Notes on using SxS memory cards

- Recorded data may be damaged or lost in the following situations:
  - If you remove this media or turn off the power while formatting, reading or writing data.
  - If you use this media in locations subject to static electricity or electrical noise.
- Do not use or store this media in the following locations:
  - Where recommended operating conditions are exceeded.
  - Inside a closed car in summer; or in strong sunshine / under direct sunlight / near a heater, etc.
  - Humid or corrosive location

- Verify the correct direction of insertion before use.
- When storing or carrying this media, put this media in the carrying case and lock it firmly.

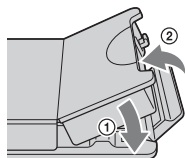

- We recommend that you make a backup copy of important data. Sony accepts no responsibility for any damage or loss of data you recorded.
- Do not apply a label sheet in places other than the label space. When applying the label sheet to this media, do not allow it to protrude from its proper location.

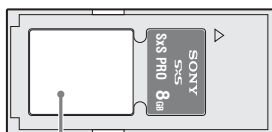

Label space

- SxS memory cards to be used with this camcorder must be formatted using the format function of this camcorder. If a card is formatted using other device, it is regarded as of a different format, requiring repeated format operation on this camcorder.
- Deleting with the function of the camcorder does not completely delete data on this media. When transferring or disposing of this media, use a commercial data deleting software or destroy the actual body at you own responsibility.
- If the available recording time on a card is short, clip operation may be restricted. In such a case, delete unnecessary files by using a PC.
- Remove or reinsert the case card with the case opened properly.

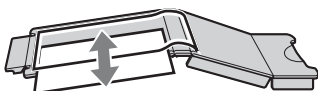

## For write protection

Setting the write-protect switch of the SxS memory card to “WP” disables you to record, edit or delete data.

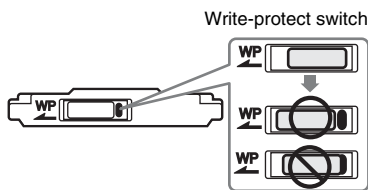

### Note

Do not operate the write-protect switch of an SxS memory card while it is set in the camcorder. Temporarily remove the card from the camcorder before changing the switch setting.

## Inserting/Removing an SxS Memory Card

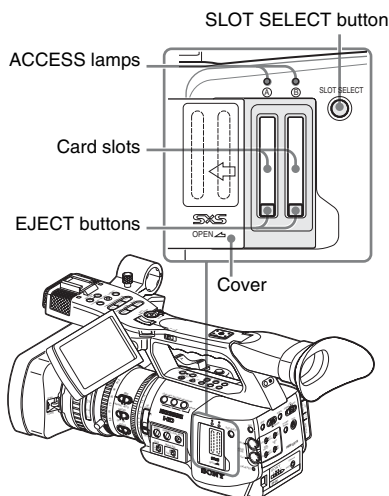

### Inserting an SxS memory card

- 1 Slide the cover to the left to open.
- 2 Insert the SxS memory card into the slot.

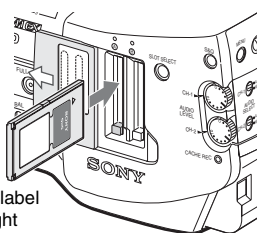

With the label facing right

The ACCESS lamp lights in red then changes to green once the memory card is ready for use.

### 3 Close the cover.

#### Status indications by the ACCESS lamps

Card slots A and B are accompanied by the respective ACCESS lamps to indicate their statuses.

Lamp	Slot statuses
Lights in red	Accessing the loaded SxS memory card (writing/reading data)
Lights in green	Standby (ready for recording or playback using the loaded SxS memory card)
Off	<ul style="list-style-type: none"> <li>No SxS memory card is loaded.</li> <li>The loaded card is invalid.</li> <li>An SxS memory card is loaded, but another slot is active.</li> </ul>

### Removing an SxS memory card

- 1 Open the cover, once press the EJECT button to release the lock, then pull the button out.

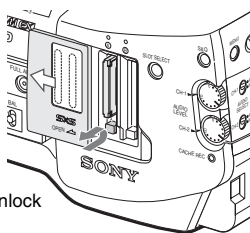

Press and unlock the button.

- 2 Press the EJECT button again to remove the card.

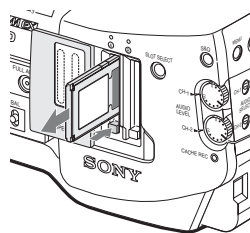

#### Notes

- Data are not guaranteed if the power is turned off or a memory card is removed while the card is being accessed. All data on the card may be destroyed. Be sure that the ACCESS lamps are lit in green or off when you turn off the power or remove memory cards.
- When you turn the camcorder on by setting the power switch to MEDIA (Media mode), a display to show that an SxS memory card is being confirmed appears on the LCD monitor/EVF screen.



The display automatically changes to the thumbnail screen (page 94) when a valid memory card is inside, but it remains on the screen if no valid memory card is loaded.

### Switching Between SxS Memory Cards

When SxS memory cards are loaded in both card slots A and B, press the SLOT SELECT button to select the card you wish to use. If a card becomes full during recording, switching to the other card is automatically executed.

#### Note

The SLOT SELECT button is disabled while playback is in progress. Switching is not executed even if you press the button. The button is enabled on the thumbnail screen (page 94).

### Formatting an SxS Memory Card

Formatting may be required before using an SxS memory card with this camcorder. For an SxS

memory card that is not formatted or that was formatted with another system, the message “Unsupported File System” is displayed on the LCD monitor/EVF screen.  
Format the card as instructed below.

#### Note on formatting

Any SxS memory card formatted with a device other than this camcorder cannot be used with the camcorder.

### To execute formatting

Using “Format Media” (page 133) of the OTHERS menu, specify “Media(A)” (slot A) or “Media(B)” (slot B) then select “Execute.”

Formatting begins.

The in-progress message and status bar (%) are displayed, and the ACCESS lamp lights in red. When formatting is completed, the completion message is displayed for three seconds.

#### Recording/playback during formatting

You can perform recording or playback using the SxS memory card in the other card slot while formatting is in progress.

#### If formatting fails

A write-protected SxS memory card or memory card that cannot be used with this camcorder will not be formatted.

As a warning message is displayed, replace the card with an appropriate SxS memory card, as per the instructions in the message.

#### Notes

- All the data, including recorded pictures and setup files, are erased when a memory card is formatted.
- SxS memory cards to be used with this camcorder must be formatted using the format function of this camcorder. Any card formatted with other device must be formatted again with this camcorder.

### Checking the Remaining Time Available for Recording

In Camera mode, you can check the time remaining for the SxS memory cards loaded in the card slots on the LCD monitor/EVF screen.



The available time for recording with the current video format (recording bit rate) is calculated according to the remaining space of each card and displayed in time units of minutes.

The remaining can also be checked in a meter format on the BATTERY/MEDIA status screen (page 113).

#### Note

A  icon appears if the memory card is write-protected.

### Replacing an SxS memory card

- If the available time on two cards in total becomes less than 5 minutes, a message “Media Near Full,” flashing of the tally lamps, and a beep sound will warn you. Replace the cards with those with sufficient space.
- If you continue recording until the total remaining time reaches zero, the message changes to “Media Full,” and recording stops.

#### Note

Approximately 600 clips can be recorded on one SxS memory card at maximum.

If the number of recorded clips reaches the limit, the remaining time indication becomes “0,” and the message “Media Full” is displayed.

### Restoring an SxS Memory Card

If an error occurs with data in a memory card for some reason, the card must be restored.

If an SxS memory card that needs to be restored is loaded, a message that prompts you to execute a restore operation is displayed on the LCD monitor/EVF screen.

### To restore a card

Select “Execute” by turning the jog dial or tilting the joystick then push the dial or joystick.

The restore operation begins.

During restoration, the in-progress message and status bar (%) are displayed, and the ACCESS lamp is lit in red.

When restoration is completed, the completion message is displayed for three seconds.

### If restoration fails

- A write-protected SxS memory card or one on which an error occurred cannot be restored. For such a card, a warning message is displayed. Release the write protection or replace the card, as per the instructions in the message.
- An SxS memory card on which an error occurred may become usable again through repeated formatting.
- In some cases, only parts of clips cannot be restored. Playback of the restored clips becomes possible again.
- The following operation may restore an SxS memory card for which the message “Could not Restore Some Clips” is repeatedly displayed each time you try the restoration process:

- 1 Copy necessary clips to another SxS memory card, using the copy function (*page 103*) of the camcorder or the XDCAM EX Clip Browsing Software (*page 138*).
- 2 Format the problem SxS memory card, using the format function of this camcorder.
- 3 Return the necessary clips to the SxS memory card by copy operation.

### Recording/playback during restoration

You can perform recording or playback using the SxS memory card in the other card slot while restoration is in progress.

#### Note

For restoration of media recorded with this unit, be sure to use this unit. Media recorded with a device other than this unit or with another unit of different version (even of the same model) may not be restored using this unit.

## Using an External Hard Disk

You can use an optional PHU-60K, PHU-120K, or PHU-120R Professional Hard Disk Unit with this camcorder.

#### Notes

- High-speed playback (*page 98*) may not be properly achieved with the PHU-60K/120K/120R.
- Slow Motion recording by the Slow & Quick Motion recording function (*page 75*) cannot be made with the PHU-60K/120K/120R.

### Attaching/Removing the PHU-60K/120K/120R

Recording/playback can be made using the PHU-60K/120K/120R in the same manner as with SxS memory cards if you connect the PHU connection cable of the PHU-60K/120K/120R to an SxS memory card slot of the camcorder.

### Mounting the hard disk unit on the camcorder

By using the cold shoe kit (an auxiliary shoe, four screws, and a bottom plate) supplied with the camcorder, you can mount the hard disk unit on the rear accessory shoe of the camcorder. Mount the auxiliary shoe on the rear accessory shoe.

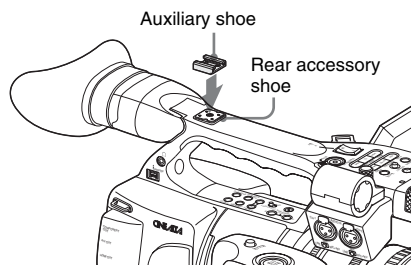

- 1 Place the auxiliary shoe on the rear accessory shoe and secure it with the four screws.

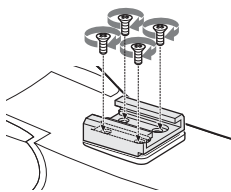

## 2 Fit the bottom plate (spring type) into the auxiliary shoe.

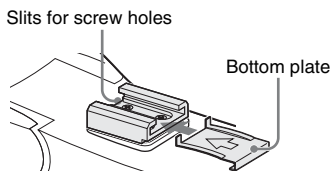

Insert the bottom plate from the end where the slits for the screw holes of the auxiliary shoe are not open.

If you secure the auxiliary shoe in the direction opposite that shown in the above figure with the slit open end forward, insert the bottom plate from the direction opposite to that shown in the figure.

## 3 Attach the shoe adapter (supplied with the PHU-60K/120K/120R) to the hard disk unit, mount the unit to the auxiliary shoe on the camcorder, and secure it with the lock lever of the shoe adapter

*For details, refer to the instructions supplied with the PHU-60K/120K/120R.*

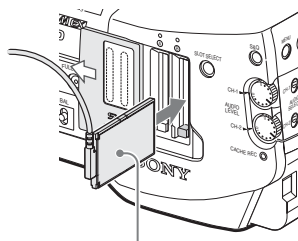

Insert so that the cable extends upward.

## 3 Turn on the PHU-60K/120K/120R.

The POWER indicator of the PHU-60K/120K/120R lights in green. Subsequently, the ACCESS lamp of the camcorder lights in red then changes to green once the unit is ready for use.

### Notes

- The cover of the card slot block cannot be closed with the PHU-60K/120K/120R connected.
- Bundle the cable so that it will not accidentally get on nearby objects.

### To disconnect the PHU connection cable

Operate in the same manner as when you remove an SxS memory card from the slot.

## Formatting the PHU-60K/120K/120R

For a PHU-60K/120K/120R that is not formatted or that was formatted with another system, the message “Unsupported File System” is displayed on the LCD monitor/EVF screen.

Format the PHU-60K/120K/120R as instructed below.

### To execute formatting

Using “Format Media” (page 133) of the OTHERS menu, specify “Media(A)” (slot A) or “Media(B)” (slot B) then select “Execute.”

Formatting begins.

An in-progress message and status bar (%) are displayed, and the ACCESS lamp lights in red. When formatting is completed, a completion message is displayed for three seconds.

## Connecting the PHU connection cable

- 1 Set the power switch of the camcorder to the CAMERA position.
- 2 Open the cover of the card slot block and plug the PHU connection cable into a slot.

**Notes**

- Formatting for the PHU-60K/120K/120R on this camcorder is “Quick Format” with which only the managerial data are erased. To erase the recording data completely, connect the unit to a PC and perform “Full Format.”
- The PHU-60K/120K/120R to be used with this camcorder must be formatted using the format function of this camcorder. Any PHU-60K/120K/120R formatted with another device must be formatted again with this camcorder.

## Checking the Remaining Time Available for Recording

In Camera mode, the remaining capacity (in minutes) of the PHU-60K/120K/120R connected via a card slot is displayed on the LCD monitor/EVF screen.

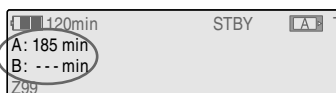

The available time for recording with the current video format (recording bit rate) is calculated according to the remaining space of the hard disk and displayed in time units of minutes.

The remaining capacity can also be checked in a meter format on the BATTERY/MEDIA status screen (*page 113*).

## Restoring the PHU-60K/120K/120R

If an error occurs with data on the PHU-60K/120K/120R for some reason, the hard disk must be restored.

If a PHU-60K/120K/120R that needs to be restored is connected, a message that prompts you to execute restoration is displayed on the LCD monitor/EVF screen.

---

### To restore the hard disk

---

**Select “Execute” by turning the jog dial or tilting the joystick then push the dial or joystick.**

The restoration begins.

During restoration, an in-progress message and status bar (%) are displayed, and the ACCESS lamp is lit in red.

When restoration is completed, a completion message is displayed for three seconds.

### If restoration fails

- A PHU-60K/120K/120R on which an error occurred may become usable again through reformatting.
- In some cases, only parts of clips cannot be restored. Playback of the restored clips becomes possible again.

## Using a Media Adaptor

Use of the optional MEAD-MS01 or MEAD-SD01 Media Adaptor permits you to insert a “Memory Stick” (with MEAD-MS01) or an SDHC card (with MEAD-SD01) to the SxS memory card slot of the camcorder and use it for recording and playback in the same way as with an SxS memory card.

### Usable “Memory Stick”

“Memory Stick PRO-HG Duo HX” series

### Usable SDHC card

Class 10 SDHC card

*For details on use of the MEAD-MS01/SD01 Media Adaptor, refer to the operating instructions of the adaptor.*

#### Notes

- High-speed playback (*page 98*) may not be properly achieved with a “Memory Stick” or an SDHC card.
- Slow Motion recording by the Slow & Quick Motion recording function (*page 75*) cannot be made with a “Memory Stick” or an SDHC card.

## Formatting

When you use a “Memory Stick” or an SDHC card with this camcorder, formatting is required. A “Memory Stick” or an SDHC card to be used with this camcorder must be formatted using the format function of this camcorder.

It is also necessary to format a “Memory Stick” or an SDHC card for use if a caution message is displayed when you mount the “Memory Stick” or SDHC card.

For a “Memory Stick” or an SDHC card that was formatted with another system unsupported by this camcorder, the message “Unsupported File System” is displayed on the LCD monitor/EVF screen.

Format the “Memory Stick” or SDHC card as instructed below.

## To execute formatting

Using “Format Media” (*page 133*) of the OTHERS menu, specify “Media(A)” (slot A) or “Media(B)” (slot B) then select “Execute.”

Formatting begins.

An in-progress message and status bar (%) are displayed, and the ACCESS lamp lights in red. When formatting is completed, a completion message is displayed for three seconds..

#### Note

In formatting, all data in a “Memory Stick” or an SDHC card including protected images, are erased and cannot be restored.

### Connection between the camcorder and a PC

To use a “Memory Stick” or an SDHC card in which data have been recorded with an XDCAM EX-series product, insert it into the slot of the camcorder and connect between the PC and this camcorder using a USB cable.

### To use a “Memory Stick” formatted with this camcorder with other devices having a “Memory Stick” slot

1. First make a backup copy of the data recorded in the “Memory Stick.”
2. When the backup is done, format the “Memory Stick” with the device to be used.

*For details on the formatting method, refer to the operating instructions of the device to be used.*

### To use an SDHC card formatted with this camcorder with other devices having an SDHC card slot

1. First make a backup copy of the data recorded in the SDHC card.
2. When the backup is done, format the SDHC card with the device to be used.

*For details on the formatting method, refer to the operating instructions of the device to be used.*

- “Memory Stick” and  MEMORYSTICK are trademarks of Sony Corporation.
- “Memory Stick PRO-HG Duo” and MEMORYSTICK PRO-HG DUO are trademarks of Sony Corporation.

# Basic Operation Procedure

Basic recording can be performed with the following procedures:

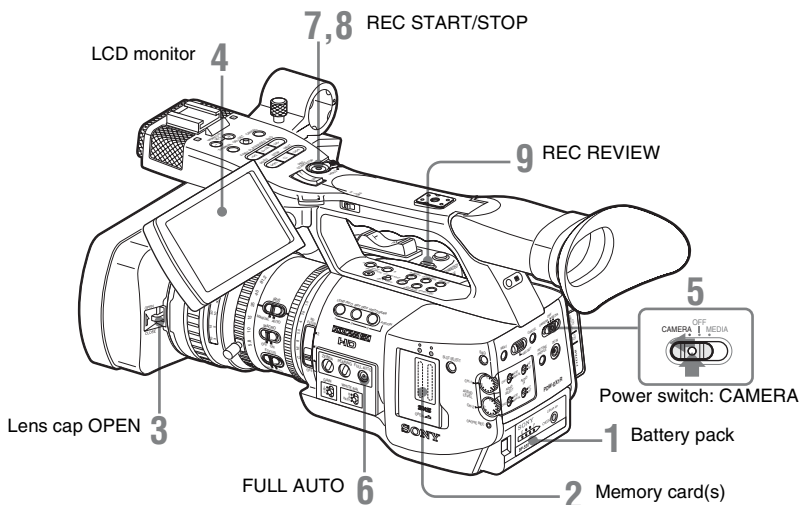

## Preparations

- 1 Mount a fully charged battery pack.**
- 2 Load SxS memory card(s).**  
If you load two cards, recording is continued by automatically switching to the second card when the first card becomes full.
- 3 Pull up on the lens cap open/close lever to open the lens cap built in the lens hood.**
- 4 Adjust the angle of the LCD monitor for the best view.**  
When you wish to use the EVF, fold the LCD monitor to its park position and adjust the angle of the EVF.
- 5 Set the power switch to the CAMERA position.**  
The camcorder is turned on and enters Camera mode.

When using the remote commander, activate the remote control mode (*page 33*).

### Note

When you hold the camcorder by the grip, support it from underneath with your left hand.

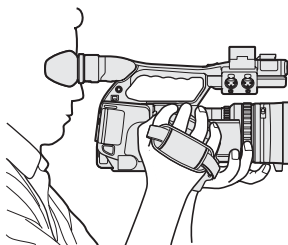

## Recording (Full Auto mode)

- 6 Press the FULL AUTO button so that the button indicator lights.**

Full Auto mode is turned on, activating the TLCS (Total Level Control System) (page 121).

Thus Auto Iris, AGC (Auto Gain Control), Auto Shutter, ATW (Auto Tracing White) are set to ON, whereby the brightness and white balance will be automatically adjusted.

When you wish to adjust them manually, turn Full Auto mode off, and see;

“Adjusting the Iris” on page 54

“Setting the Gain” on page 51

“Setting the Electronic Shutter” on page 52

“Adjusting the White Balance” on page 47

#### Note

AF (Auto Focus) is not activated by setting the camcorder to Full Auto mode.

For information of automatic focus adjustment, see page 59.

## 7 Press the REC START/STOP button.

You can start with either of the REC START/STOP button on the handle or that on the grip.

(If you are using the IR Remote Commander, press the REC button simultaneously with the unmarked button.)

The front and rear tally lamps light and recording begins.

## 8 To stop recording, press the REC START/STOP button again.

(If you are using the IR Remote Commander, press the REC PAUSE button simultaneously with the unmarked button.)

Recording stops and the camcorder enters STBY (recording standby) mode.

#### Note

If you press the REC START/STOP button to start next recording while previous data writing is not completed, the message “Cannot Proceed” may be displayed and recording may not start.

### To prevent a switching error

The REC START/STOP button on the handle is incorporated with the REC HOLD lever. If the REC START/STOP button on the handle will not be used, it is recommended to set the lever to the HOLD position to lock the button.



REC HOLD lever

To unlock the button, return the lever to its original position.

## Checking the last recorded clip (Rec Review)

### 9 Press the REC REVIEW button.

The Rec Review function (page 68) is activated, and the last recorded clip is played back for the specified time on the LCD monitor/EVF screen.

When playback reaches the end of the clip, the camcorder returns to STBY (recording standby) mode.

### To delete clips

You can delete the last recorded clip by using the Last Clip DEL function.

See “Deleting the Last Recorded Clip” on page 92.

Use the All Clips DEL function when you wish to delete all recorded clips from a memory card.

See “Deleting Clips Collectively” on page 92.

To specify a clip to be deleted, operate the camcorder in Media mode.

See “Deleting Clips” on page 104.

**Clip (recording data) and clip name**

When you stop recording, video, audio and subsidiary data from the start to end of the recording are recorded as a single clip on an SxS memory card.

For each clip recorded with this camcorder, a clip name composed of 4 to 46 alphanumeric and 4 numerics is automatically generated.

**Example:** ABCD0001

The block of 4 to 46 alphanumeric can be specified as desired using “Clip” (*page 133*) of the OTHERS menu before you start recording. (It cannot be changed after recording.)

The value of the 4 numerics is automatically counted up in sequence.

**Notes on Clips**

The XDCAM EX-series products limit the maximum file size of an HD clip to 4GB and that of an SD clip to 2GB. If you continue recording for an extended period, recorded materials may be segmented into multiple files, depending on the file size (the maximum number of partitions is 99). The camcorder regards continuous recording as one clip even if it has been segmented into multiple files.

A long clip can be recorded crossing over two memory cards in slot A and B.

When you copy clips to a hard disk drive, etc. using a computer, it is recommended to use the XDCAM EX Clip Browsing Software on the supplied CD-ROM.

**Note**

If copying is done using Explorer (Windows) or Finder (MAC), the continuity and relationships of recorded materials may not be maintained.

**Maximum duration of a clip**

In HD Mode, a clip can be 24 hours long at maximum. If a clip exceeds 24 hours, it is automatically divided.

## Selecting the Video Format

You can select various video formats for recording/playback using “HD/SD Mode” and “Video Format” of the OTHERS menu.

The current format is displayed on the screen when you press the DISPLAY/BATT INFO button.

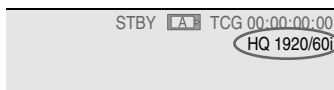

### Selectable Formats

The selectable formats vary depending on the “HD/SD Mode” setting and “Country” (NTSC Area/PAL Area) setting (*page 132*) of the OTHERS menu.

#### HD Mode

When the camcorder is set to HD Mode, the video formats set on this camcorder cover the recording bit rate (HQ/SP), recording picture size (horizontal resolution), recording frame rate, and recording scan system (*i/P*).

The frame rates are indicated with two-digit integers, rounding off the fractional part.

When you select an HQ format, recording is made with the bit rate of 35 Mbps VBR.

When you select an SP format, recording is made with the HDV-compatible bit rate of 25 Mbps CBR.

**With “NTSC Area” selected**

Format	Indication on this camcorder
HQ 1920 × 1080 59.94 interlace	HQ 1920/60i
HQ 1440 × 1080 59.94 interlace	HQ 1440/60i
SP 1440 × 1080 59.94 interlace	SP 1440/60i
HQ 1920 × 1080 29.97 Progressive	HQ 1920/30P

Format	Indication on this camcorder
HQ 1440 × 1080 29.97 Progressive	HQ 1440/30P
HQ 1920 × 1080 23.98 Progressive	HQ 1920/24P
HQ 1440 × 1080 23.98 Progressive	HQ 1440/24P
SP 1440 × 1080 23.98 Progressive	SP 1440/24P
HQ 1280 × 720 59.94 Progressive	HQ 1280/60P
HQ 1280 × 720 29.97 Progressive	HQ 1280/30P
HQ 1280 × 720 23.98 Progressive	HQ 1280/24P

#### With “PAL Area” selected

Format	Indication on this camcorder
HQ 1920 × 1080 50 interlace	HQ 1920/50i
HQ 1440 × 1080 50 interlace	HQ 1440/50i
SP 1440 × 1080 50 interlace	SP 1440/50i
HQ 1920 × 1080 25 Progressive	HQ 1920/25P
HQ 1440 × 1080 25 Progressive	HQ 1440/25P
HQ 1280 × 720 50 Progressive	HQ 1280/50P
HQ 1280 × 720 25 Progressive	HQ 1280/25P

#### SD Mode (DVCAM mode)

When the camcorder is set to SD Mode, the video formats set on this camcorder cover the recording frame rate, recording scan system (i/P), and aspect (SQ/EC).

The frame rates are indicated with two-digit integers, rounding off the fractional part.

When you select SD Mode, recording is made with the bit rate of 25 Mbps CBR.

#### With “NTSC Area” selected

Format	Indication on this camcorder
720 × 480 59.94 interlace, squeeze	DVCAM60i SQ
720 × 480 59.94 interlace, edge crop	DVCAM60i EC

Format	Indication on this camcorder
720 × 480 29.97 Progressive, squeeze	DVCAM30P SQ
720 × 480 29.97 Progressive, edge crop	DVCAM30P EC

#### With “PAL Area” selected

Format	Indication on this camcorder
720 × 576 50 interlace, squeeze	DVCAM50i SQ
720 × 576 50 interlace, edge crop	DVCAM50i EC
720 × 576 25 Progressive, squeeze	DVCAM25P SQ
720 × 576 25 Progressive, edge crop	DVCAM25P EC

### Switching between HD and SD

For HD/SD switching use “HD/SD Mode” of the OTHERS menu.

When you change the menu setting, the camcorder automatically restarts, executing the switching.

#### Note

HD/SD switching is disabled during recording and playback.

- 1 Press the MENU button to set the camcorder to Menu mode, display the OTHERS menu with , and select “HD/SD Mode.”

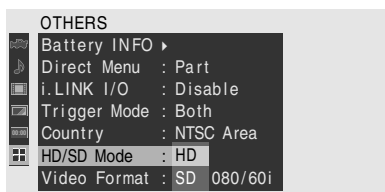

- 2 Select the desired mode.

A confirmation message is displayed.

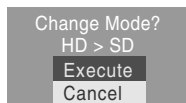

### 3 Select “Execute.”







The camcorder is automatically turned off, then is restarted, activating the menu setting.

For details on menu operations, see “Basic Menu Operations” on page 115.

For the menu items “Video Format,” “Output Select” and “i.LINK I/O” the settings for HD Mode and those for SD Mode are independently stored in memory. When you switch between HD and SD, these items are automatically changed to the conditions corresponding to the selected mode.

## Changing the Format

Press the MENU button to set the camcorder to Menu mode, display the OTHERS menu with , and set “Video Format.”

OTHERS	
	Direct Menu : HQ 1920/60i
	i.LINK I/O : HQ 1440/60i
	Trigger Mode : SP 1440/60i
	Country : HQ 1920/30P
	HD/SD Mode : HQ 1440/30P
	Video Format : HQ 1920/24P
	Clip ▶ HQ 1440/24P

For details on menu operations, see “Basic Menu Operations” on page 115.

Signals from the COMPONENT OUT, SDI OUT, A/V OUT, and HDMI OUT connectors are also output according to the format selected with this menu.

See “Formats and Limitations of Outputs” on page 145.

### Note on recording format in SP 1440/24P mode

When recording in SP 1440 × 1080 mode at 23.98 in Progressive mode (indicated as SP 1440/24P on this camcorder), pictures are recorded at 59.94 in Interlace mode (indicated as SP 1440/60i) by pull-down processing.

## Switching the ND Filters

ND filters are available for keeping the aperture in a proper range.

Set the ND filter switch according to the brightness of the subject.

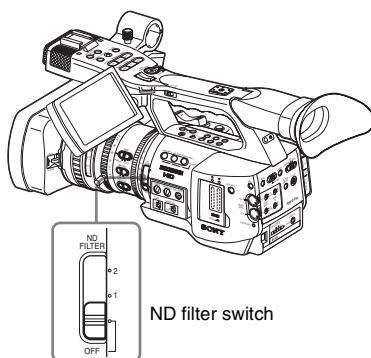

- 2:  $1/64$ ND
- 1:  $1/8$ ND
- OFF: Clear

The ND filter number is displayed on the screen when you press the DISPLAY/BATT INFO button.

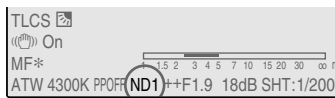

### Note

No indication is obtained if the ND filter switch is set to OFF.

# Adjusting the White Balance

The white balance must be adjusted to suit to the color temperature of the light source. You can select the adjustment mode according to the shooting conditions.

## Preset mode

The color temperature is adjusted to the preset value (factory setting: 3200K) in this mode. Select this mode when there is no time to adjust the white balance or when you wish to fix the white balance to the condition of you set for a Picture Profile.

## Memory A mode, Memory B mode

- The white balance is adjusted to the value stored in memory A or memory B.
- Pressing the WHT BAL button executes auto white balance and stores the adjusted value in memory A or memory B.

## ATW (Auto-Tracing White balance) mode

In this mode, the camcorder automatically adjusts the white balance to the appropriate condition. When the color temperature of the light source changes, the white balance adjustment is automatically executed.

Five steps of adjustment speed can be selected with “ATW Speed” (page 122) of the CAMERA SET menu.

### Holding the ATW value

When the ATW Hold function is assigned to an assignable button, you can momentarily hold the ATW value to fix the white balance, even in ATW mode, by pressing the button.

For details on the assignable buttons, see “Changing Functions of the Assignable Buttons” on page 69.

## Selecting the Adjustment Mode

### Using the switch

You can select Preset mode, Memory A mode, or ATW (Memory B) mode with the WHITE BAL switch.

To the B position of the WHITE BAL switch, ATW mode is assigned at the factory. The setting can be changed with “White Switch <B>” (page 122) of the CAMERA SET menu to select Memory B mode.

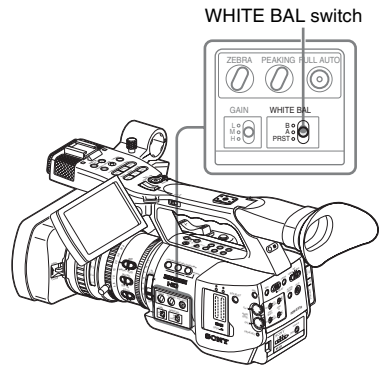

- B:** ATW or Memory B mode
- A:** Memory A mode
- PRST:** Preset mode

- Setting the camcorder to Full Auto mode (page 42) forcibly activates ATW mode.
- Assigning the ATW on/off function to an assignable button permits you to independently activate/deactivate ATW when Full Auto mode is off.

For details on the assignable buttons, see “Changing Functions of the Assignable Buttons” on page 69.

## Using the Direct menu

When you press the DISPLAY/BATT INFO button, the current adjustment mode and color temperature are displayed on the screen.

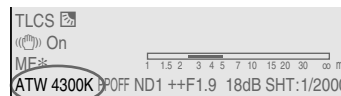

- ATW:** ATW mode
- W:A:** Memory A mode
- W:B:** Memory B mode
- W:P:** Preset mode

When the Direct menu is in All mode, you can select from among ATW, W:A, W:B, and W:P.

When the Direct menu is in Part mode, you can switch between ATW and the mode set with the WHITE BAL switch.

For details on the Direct menu, see “Direct Menu Operation” on page 24.

## Executing Auto White Balance

Execute auto white-balance adjustment according to the color temperature of the light source. The adjustment value can be stored in memory A or B.

### Note

Auto white-balance adjustment cannot be executed in Preset mode.

- 1 To store the adjustment value in memory, select Memory A or Memory B mode.**
- 2 Select the appropriate ND filter according to the lighting condition.**
- 3 Place a white subject under the same lighting condition and zoom in on it so that a white area is obtained on the screen.**

A white object (white cloth, a white wall, etc.) near the subject may be used in place. Be careful not to have any spots of high illumination on the screen.

- 4 Adjust the lens iris opening.**  
Set it to the proper condition if the manual iris adjustment mode is selected.
- 5 Press the WHT BAL button.**  
Auto white-balance adjustment begins.

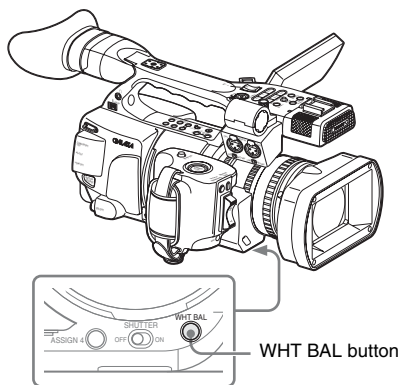

WHT BAL button

During adjustment, an in-progress message is displayed on the screen. When the adjustment is completed successfully, the message changes to a completion message, and the obtained color temperature is displayed.

- When you execute the adjustment in a memory mode, the adjusted value is stored in memory (A or B) selected in step 1.
- When you execute the adjustment in ATW mode, adjustment in ATW is resumed.

### If auto white-balance adjustment fails

An error message is displayed on the screen for approximately three seconds.

If the error message is displayed, try auto white-balance adjustment again.

If the error message continues to be displayed after several attempts, consult your Sony service representative.

# Displaying the Markers and Zebra Patterns

During recording, various markers and zebra patterns can be inserted into the image on the LCD monitor/EVF screen.

This does not affect recording signals.

## Displaying the Markers

Use “Marker” of the LCD/VF SET menu.

Press the MENU button to set the camcorder to Menu mode, display the LCD/VF SET menu with , and select “Marker” from the menu.



## Activating the marker indications

- Set “Setting” to “On” then turn the markers on/off independently.  
No marker is displayed when “Setting” is “Off.”
- Assigning the Marker on/off function to one of the assignable buttons permits you to operate “Setting: On/Off” by pressing the button.

For the assignable buttons, see “Changing Functions of the Assignable Buttons” on page 69.

## Displaying the safety-zone marker

Set “Safety Zone” to “On” to insert the safety-zone marker to the screen.

With “Safety Area” you can select the size of the safety-zone marker from among 80%, 90%, 92.5%, and 95% of the picture area.

Example: 95%

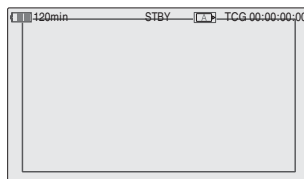

When the aspect marker is on, the safety zone marker shows the effective area within the aspect marker.

## Displaying the center marker

Set “Center Marker” to “On” to insert the center marker into the screen area.

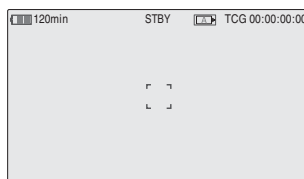

## Displaying the aspect marker

Set “Aspect Marker” to “Line” or “Mask” to insert the aspect marker into the screen area.

**Line:** To show as white lines

**Mask:** To display by lowering the video signal level of areas outside the marker range

You can select the ratio of the aspect marker from among 4:3, 13:9, 14:9, 15:9, 1.66:1, 1.85:1, 2.35:1, and 2.4:1 with “Aspect Select.”

Example: 4:3

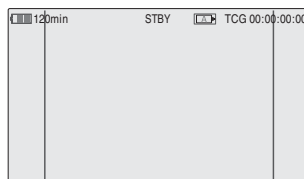

When you set “Aspect Marker” to “Mask,” you can also change the brightness of images outside the aspect marker with “Aspect Mask.” It can be selected in the range of 0% to 90% (10% steps).

### Note

No aspect marker is displayed when a video format of EC (Edge Crop) is selected in SD Mode.

## Displaying the guide frame lines

Set “Guide Frame” to “On” to insert the guide frame lines into the screen area.

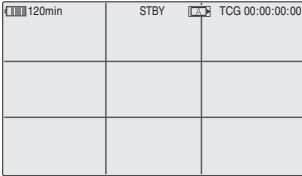

Recording

## Displaying the Zebra Patterns

A zebra pattern(s) can be inserted to the picture on LCD monitor/EVF screen to check the appropriate luminance level.

Factory-set zebras

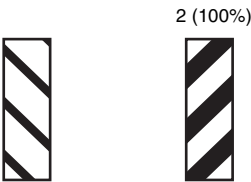

## Turning the zebra-pattern indication on/off

Pressing the ZEBRA button turns the zebra pattern-indication on/off.

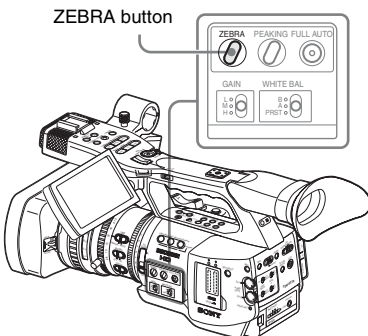

## Changing the zebra pattern

Using “Zebra” of the LCD/VF SET menu, you can change the zebra pattern to be displayed. Press the MENU button to set the camcorder to Menu mode, display the LCD/VF SET menu with , and select “Zebra” from the menu.

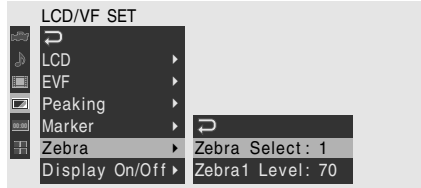

### Zebra Select

Select the zebra pattern(s) to be displayed.

**1 (Zebra1):** To display a zebra pattern in the area of  $\pm 10\%$  centering the video level set with “Zebra1 Level.”

**2 (Zebra2):** To display a zebra pattern for the video level over 100%.

**Both:** To display both Zebra1 and Zebra2.

### Zebra1 Level

Set the center level of Zebra1 in the range of 50 to 107%. The default setting is 70%.

## Setting the Gain

You can set the gain of the video amplifier according to the brightness of the subject. Select the setting mode required by the shooting conditions.

### Fixed gain mode (manual gain adjustment)

Select the gain of the video amplifier, using the switch or a menu operation.

### AGC mode (automatic gain control)

The gain of the video amplifier is automatically adjusted according to the picture brightness.

## Recording With Fixed Gain

### Selecting the gain with the switch

Select the gain, using the GAIN switch.

#### Note

When AGC mode is on, the fixed gain cannot be selected.

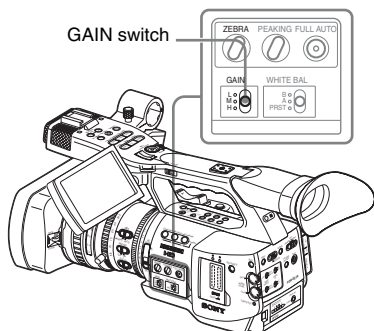

The gain value at each of the switch positions are set at the factory are as follows:

**L:** 0 dB

**M:** 9 dB

**H:** 18 dB

These values can be changed in the range of -3 dB to +18 dB, using the CAMERA SET menu.

### To change

Press the MENU button to set the camcorder to Menu mode, display the CAMERA SET menu with , and select “Gain Setup” from the menu.

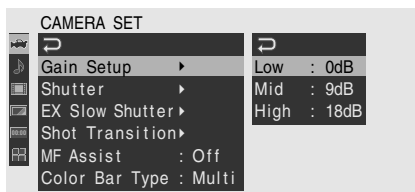

For details on menu operations, see “Basic Menu Operations” on page 115.

### Selecting gain using the Direct menu

When you press the DISPLAY/BATT INFO button, the current gain value is displayed on the screen.

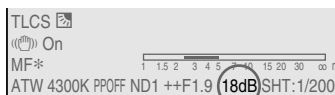

When the Direct menu is in All mode, you can change the gain in steps of 3 dB with the Direct menu by operating the joystick or the jog dial. You can also select AGC mode with the Direct menu.

When the Direct menu is in Part mode, you can switch between AGC and the gain selected with the GAIN switch.

#### Note

When the camcorder is in Full Auto mode (page 42), the Direct menu cannot be selected.

For details on the Direct menu, see “Direct Menu Operation” on page 24.

### Recording in AGC Mode

When you set the camcorder to Full Auto mode (page 42), AGC mode is forcibly selected.

When Full Auto mode is off, you can independently turn AGC mode on by setting “AGC” to “On” with “TLCS” (page 121) of the CAMERA SET menu or selecting AGC with the Direct menu.

## Setting the Electronic Shutter

The electronic shutter of the camcorder permits you to change the shutter speed (the accumulation time per recording frame).

The electronic shutter can be adjusted automatically or manually as required.

### Fixed Shutter (manual adjustment) modes

Recording is made with a specified shutter speed (accumulation time).

#### Standard modes (Speed mode/Angle mode)

These modes may be especially effective when you wish to record a quick-moving subject with little blurring.

You can select Speed mode or Angle mode. In Angle mode, you can specify the shutter speed by setting the shutter angle.

#### ECS (Extended Clear Scan) mode

Specify the shutter speed by frequency. This mode may be used to shoot the monitor screen eliminating horizontal bands.

#### SLS (Slow Shutter) mode

For shooting a subject in low-level lighting conditions. Specify the shutter speed in the number of accumulated frames.

### EX Slow Shutter mode

This is an advanced mode of SLS mode. The shutter speed is specified in the number of accumulated frames. Up to 64 frames can be accumulated in this mode, permitting you to obtain low-noise clear pictures in low light levels or a surreal pictures with afterimages.

### Auto Shutter mode

The shutter speed is automatically adjusted according to the picture brightness.

## Shooting in a Fixed Shutter Mode

When you set the SHUTTER switch to ON, the fixed shutter is turned on in the mode and with the

shutter speed you specified with “Shutter” of the CAMERA SET menu.

### Note

When Auto Shutter mode is ON, the fixed shutter cannot be selected.

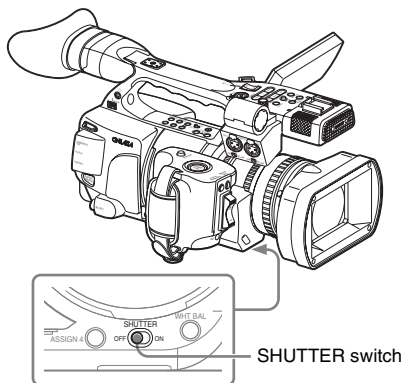

### Setting the fixed shutter with the CAMERA SET menu

The shutter mode and shutter speed can be set with the CAMERA SET menu.

Press the MENU button to set the camcorder to Menu mode, display the CAMERA SET menu with , and select “Shutter.”

CAMERA SET	
Gain Setup ▶	Mode : Speed
Shutter ▶	Shutter Speed: 1/125
EX Slow Shutter ▶	Shutter Angle: 180°
Shot Transition ▶	ECS Frequency: 60.02
MF Assist : Off	SLS Frame : 2
Color Bar Type : Multi	

### Speed (standard speed) mode

Set “Mode” to “Speed,” and specify the time ([ 1/setting value ] sec.) with “Shutter Speed.”

The available setting values vary depending on the current frame rate.

Frame rate	Shutter speed (sec.)
60i, 60P	1/60, 1/100, 1/120, 1/125, 1/250, 1/500
50i, 50P	1/1000, 1/2000
24P	1/32, 1/48, 1/50, 1/60, 1/96, 1/100, 1/120, 1/125, 1/250, 1/500, 1/1000, 1/2000

Frame rate	Shutter speed (sec.)
25P	$1/33$ , $1/50$ , $1/60$ , $1/100$ , $1/120$ , $1/125$ , $1/250$ , $1/500$ , $1/1000$ , $1/2000$
30P	$1/40$ , $1/50$ , $1/60$ , $1/100$ , $1/120$ , $1/125$ , $1/250$ , $1/500$ , $1/1000$ , $1/2000$

### Angle (standard angle) mode

Set “Mode” to “Angle,” and specify the shutter angle with “Shutter Angle.”

You can select from among 180, 90, 45, 22.5, and 11.25 degrees.

### ECS (Extended Clear Scan) mode

Set “Mode” to “ECS,” and specify the frequency with “ECS Frequency.”

The available setting values vary depending on the current frame rate.

### SLS (Slow Shutter) mode

Set “Mode” to “SLS,” and specify the number of accumulated frames with “SLS Frame.”

You can select in the range of 2 to 8 frames.

#### Note

Slow Shutter cannot be used in SP 1440/24P mode or Slow & Quick Motion mode.

## Setting with the Direct menu

When you press the DISPLAY/BATT INFO button, the current shutter mode and the set value are displayed.

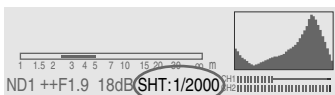

When the Direct menu is in All mode, you can change the shutter mode and speed with the Direct menu by operating the joystick or the jog dial.

#### Notes

- When the Direct menu is in Part mode, you cannot turn the shutter on/off with the Direct menu if the SHUTTER switch is set to ON. If the SHUTTER switch is set to OFF, only switching between Auto Shutter and Shutter OFF.
- The Direct menu cannot be selected when the camcorder is in Full Auto mode (page 42) or when the EX Slow Shutter mode is set to “On.”

For details on the Direct menu, see “Direct Menu Operation” on page 24.

## Shooting in EX Slow Shutter Mode

Select “EX Slow Shutter” from the CAMERA SET menu.

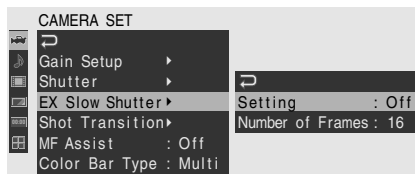

Set “Setting” to “On,” and specify the number of accumulated frames with “Number of Frames.” You can select from among 16, 32, and 64 frames.

#### Notes

- EX Slow Shutter cannot be used in SP 1440/24P mode or Slow & Quick Motion mode.
- The SHUTTER switch has no effect on the EX Slow Shutter setting.
- The EX Slow Shutter On/Off setting cannot be changed during recording.
- You cannot set the camcorder to Full Auto mode (page 42) when the EX Slow Shutter mode is set to “On.”

## Shooting in Auto Shutter Mode

When you set the camcorder to Full Auto mode (page 42), Auto Shutter is forcibly selected. When Full Auto mode is off, you can independently turn Auto Shutter mode on by setting “Auto Shutter” to “On” with “TLCS” (page 121) of the CAMERA SET menu.

## Adjusting the Iris

Adjust the iris opening according to the brightness of the subject. You can adjust it manually or automatically.

### Auto Iris mode

The iris is automatically adjusted according to the brightness of the subject.

### Manual Iris mode

Adjust the iris opening using the iris ring or with a menu operation.

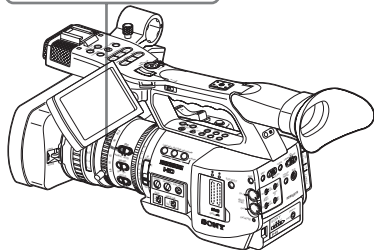
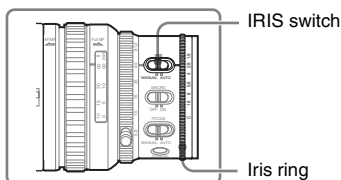

## Recording in Auto Iris Mode

When the camcorder is in Full Auto mode (page 42), Auto Iris mode is forcibly turned on.

When Full Auto mode is off, you can turn it on by setting the IRIS switch to AUTO.

You can select the target level (to make the picture brighter or darker) of the Auto Iris control. (The gain control in AGC mode and the shutter speed control in Auto Shutter mode are adjusted in synchronization.)

### To adjust the target level with the Setup menu

Set "Level" of "TLCS" (page 121) of the CAMERA SET menu.

### To adjust the target level with the Direct menu

The target level can also be selected using the Direct menu.

When you press the DISPLAY/BATT INFO button, the current setting is displayed on the screen.

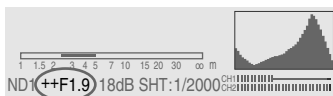

You can change the setting with the Direct menu by operating the joystick or the jog dial.

For details on the Direct menu, see "Direct Menu Operation" on page 24.

## Adjusting the Iris Manually

Set the IRIS switch to MANUAL to adjust the iris manually.

Rotate the iris ring for the desired iris opening.

### To momentarily switch to Auto iris mode

When you press the IRIS button in Manual Iris mode (IRIS switch: MANUAL), Auto Iris control is activated while you hold the button pressed.

Manual Iris mode is restored when you release the button.

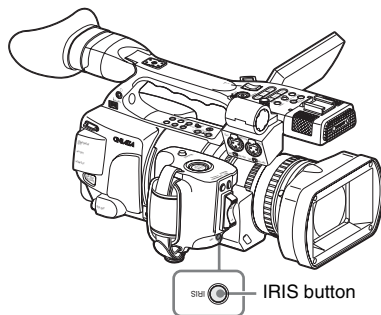

## Adjusting the Zoom

You can adjust the zoom in Manual mode or Power (Servo) mode on this camcorder.

### Manual Zoom mode

Rotate the zoom ring to adjust the zoom.

### Power Zoom (Servo) mode

You can adjust the zoom by pressing the power zoom lever or zoom button on the handle. The supplied IR Remote Commander and optional lens remote control unit can also be used.

The current zoom position is displayed on the screen in the range of 0 (Wide) to 99 (Tele) when you press the DISPLAY/BATT INFO button.

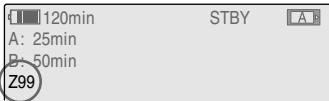

The numerical indication can be changed to that in a bar by changing the “Zoom Position” setting of “Display On/Off” (page 127) of the LCD/VF SET menu.



## Switching the Zoom Mode

Switching between Manual mode and Servo mode is performed with the ZOOM switch located on the bottom of the camcorder.

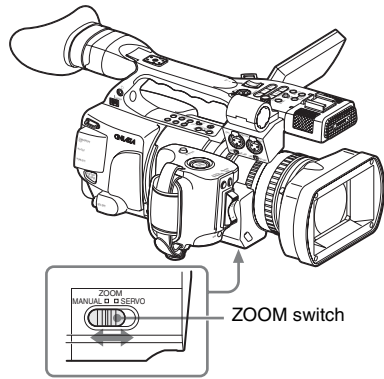

## Operating the Zoom Manually

Setting the ZOOM switch to the MANUAL position for Manual Zoom mode activates the zoom ring.

Rotate the zoom ring to adjust the zoom.

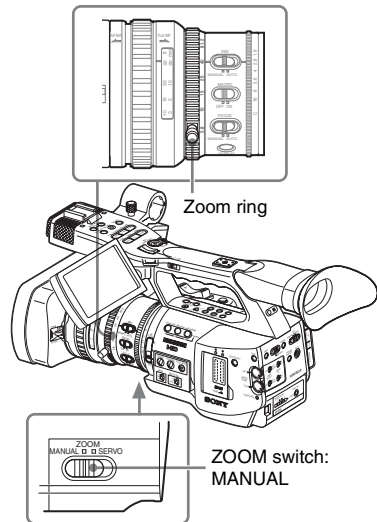

## Using the Power Zoom

Setting the ZOOM switch to the SERVO position for Servo mode activates the power zoom.

In Servo mode, the power zoom lever on the grip and the ZOOM button on the handle are activated.

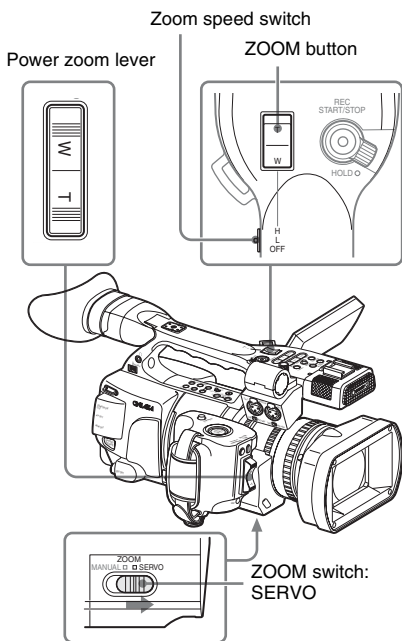

### To adjust with the power zoom lever on the grip

Press the W (wide) side for a wider angle or the T (telephoto) side for a closer angle. Pressing the lever deeper sets zooming faster.

### To adjust with the ZOOM button on the handle

Press the W side for a wider angle or the T side for a closer angle.

Zooming is activated at the speed selected with the speed switch.

The zoom speed assignment can be changed with “Zoom Speed” (page 119) of the CAMERA SET menu.

Speed switch	ZOOM button operation
H	Zoom changes with the speed set by “High” of “Zoom Speed” of CAMERA SET menu. (Default: 70)
L	Zoom changes with the speed set by “Low” of “Zoom Speed” of CAMERA SET menu. (Default: 30)
OFF	Disabled.

#### Note

Zoom operation is guaranteed with the zoom speed settings from 8 to 99.

### To select the operation at the beginning and the end of zooming

You can select Soft mode for zooming, in which the zooming speed is gradually increased at the beginning then gradually decreased for the end. Use “Zoom Trans” (page 120) of the CAMERA SET menu.

Zoom Trans setting	Operation at the beginning and the end of zooming
Linear (Default)	Zooming immediately begins at the specified speed when the ZOOM button is pressed and immediately ends when the button is released.
Soft	Zooming gradually increases the speed up to the specified speed after the ZOOM button is pressed and gradually decreases the speed and ends after the button is released. (1 second at maximum from when the button is released till the operation ends.)

#### Note

If “Zoom Speed” is set to a value less than 20, the operation becomes the same as “Linear,” even when “Soft” is selected.

### When adjusting with the ZOOM button of the IR Remote Commander

The zooming speed depends on the “Remote” setting (default: 50) of “Zoom Speed” of the CAMERA SET menu.

#### Note

Zoom operation is guaranteed with the zoom speed settings from 8 to 99.

To use the IR Remote Commander, see “Using the IR Remote Commander” on page 33.

### When using a lens remote controller

Zooming can also be controlled from an optional lens remote controller connected via the LENS REMOTE connector.

For operation of the optional lens remote controller, refer to the operation guide of the lens remote controller.

# Adjusting the Focus

You can select any of three modes for focus adjustments.

## Full MF (Full Manual Focus) mode

Only adjustment with the focus ring is effective in this mode.

You can adjust the focus from  $\infty$  to the minimum length by rotating the ring. The ring rotates endlessly in the both directions.

## MF (Manual Focus) mode

In this mode, auto focus can be temporarily activated by pushing the PUSH AF button. The MF Assist function can be used for assistance.

## AF (Auto Focus) mode

Auto focus functions continuously in this mode. The focus ring and the PUSH AF button can also be used.

### Note

The infinity position has some margin to compensate for focus change caused by variation in ambient temperature. When shooting an image at infinity in MF or Full MF mode, adjust the focus while observing the image on the LCD monitor/EVF screen.

## Adjusting in Full MF Mode

Pull the focus ring rearward (toward the camcorder body) to set the camcorder to Full MF mode. Focus can only be adjusted with the focus ring manually.

### Note

The focus instantly moves to the range index position when you pull the focus ring rearward.

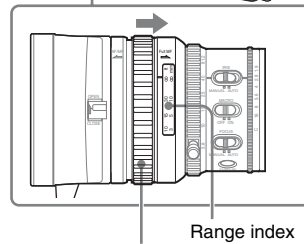
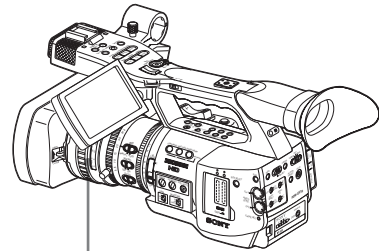

Focus ring: Rearward

Rotate the focus ring for the best focus while observing the picture on the LCD monitor/EVF screen.

The range index of the focus ring is effective in Full MF mode. The distances correspond to the focus ring positions.

## Expanded Focus

When you press the EXPANDED FOCUS button, the center area of the picture is magnified on the LCD monitor/EVF screen, making the focus adjustment easier.

Press the EXPANDED FOCUS button again or leave the focus ring unmoved for 5 seconds to resume the normal angle for recording.

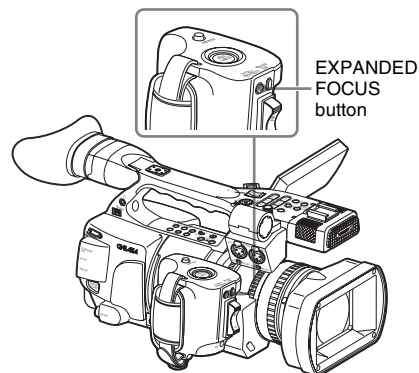

## Peaking

When you press the PEAKING button, the peaking function is activated. This function emphasizes the contours of the images on the LCD monitor/EVF screen, making manual focusing easier.

This function does not affect recording signals. The emphasis level and color of the contours can be set with “Peaking” (page 125) of the LCD/VF SET menu.

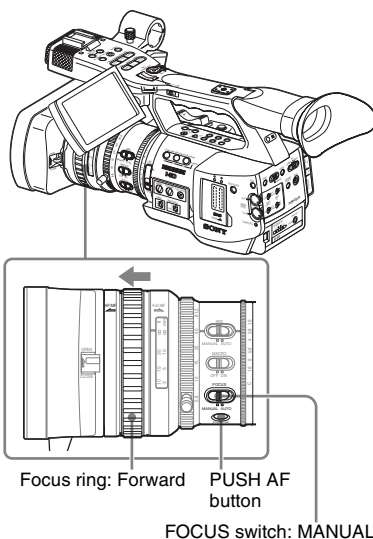
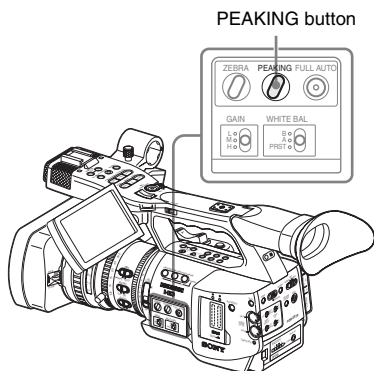

## Adjusting in MF Mode

Slide the focus ring forward (toward the lens hood) and set the FOCUS switch to MANUAL to set the camcorder to MF mode. In this mode, you can activate Auto Focus only when required.

## Adjusting the focus with the focus ring

Rotate the focus ring for the best focus while observing the picture on the LCD monitor/EVF screen.

The range index of the ring is invalid in MF mode.

## One-Push (Momentary) Auto Focusing

Push the PUSH AF button. Auto focusing momentarily activates (One-Push Auto Focusing).

One-Push Auto Focusing is terminated when the subject comes in focus.

## MF Assist function

When you stop rotating the focus ring with the MF Assist function active, auto focusing starts, performing fine focus adjustment for the subject in the center of the screen. When the fine adjustment is completed, automatic focusing with the MF Assist function is terminated.

### Activating the MF Assist function using the CAMERA SET menu

Set “MF Assist” (page 119) of the CAMERA SET menu to “On.”

## Activating the MF Assist function using the Direct menu

The current focus adjustment mode is displayed on the screen when you press the DISPLAY/BATT INFO button.

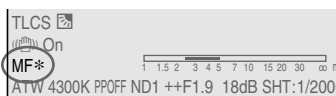

In MF mode, you can activate/deactivate the MF Assist function with the Direct menu by operating the joystick or jog dial.

When the function is active, an asterisk mark is displayed to the right of the mode indication.

### Note

The Direct menu cannot be selected in a mode other than MF mode.

For details on the Direct menu, see “Direct Menu Operation” on page 24.

## Adjusting in AF Mode

Slide the focus ring forward (toward the lens hood) and set the FOCUS switch to AUTO to set the camcorder to AF mode. In this mode, focus is always adjusted automatically.

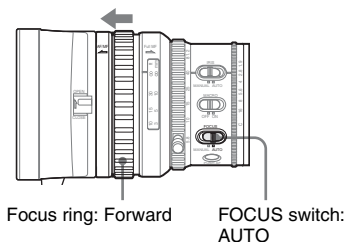

The range index of the ring is invalid in AF mode.

## Focusing in AF mode

In AF mode the camcorder continuously checks changes of images and activates auto focusing each time it detects a change. The auto focus adjustment is terminated when the subject comes into focus, and the camcorder stands by until the next change is detected.

In AF mode, auto focusing is also activated when you press the PUSH AF button or operate the focus ring.

## Using Macro Mode

When you set the MACRO switch to ON in AF or MF mode, Macro mode is activated, permitting you to adjust the focus in a range that includes the micro area.

The Macro mode is invalid in Full MF mode.

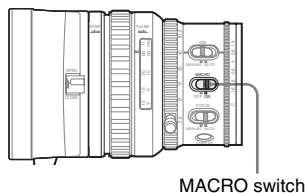

## Eliminating Picture Blurring (Steady Shot)

By activating the Steady Shot function, blurring of images due to camera shaking can be reduced.

### Setting with the CAMERA SET menu

Set “Steady Shot” (*page 122*) of the CAMERA SET menu to “On.”

### Setting with the Direct menu

When you press the DISPLAY/BATT INFO button, the setting of the Steady Shot function is displayed on the screen.

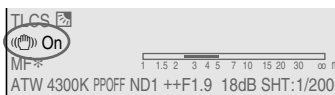

You can turn it on/off with the Direct menu by operating the joystick or the jog dial.

For details on the Direct menu, see “Direct Menu Operation” on *page 24*.

### Note on use of a wide-conversion lens

Two operation modes are provided for Steady Shot: Normal mode and Wide mode (for a wide conversion lens).

When you attach the optional VCL-EX0877 wide conversion lens, be sure to set “Wide Conversion” (*page 122*) of the CAMERA SET menu to “On.”

#### Note

If the camcorder is fixed to a tripod for stable condition, deactivate the Steady Shot function.

## Reducing Flickers

To reduce flickers, try either of the following two methods:

### Setting the shutter speed according to the power-supply frequency

Activate the electronic shutter (*page 52*) and set the shutter speed according to the power supply frequency.

#### When the frequency is 50 Hz

Set the shutter speed to  $1/50$  or  $1/100$  seconds.

#### When the frequency is 60 Hz

Set the shutter speed to  $1/60$  or  $1/120$  seconds.

### Using the Flicker-Reduction function

Set “Mode” of “Flicker Reduce” (*page 119*) of the CAMERA SET menu to “Auto” or “On” and set “Frequency” to the power-supply frequency (50 Hz or 60 Hz).

#### Note

If the frame rate selected for recording is close to the power-supply frequency, flicker may not be reduced sufficiently even if you activate the Flicker-Reduction function. In such cases, use the electronic shutter.

### Recommended settings for flicker reduction

#### Frequency

Always set “Frequency” to the power-supply frequency value appropriate for the shooting area.

#### Mode

- It is recommended to set “Mode” to “Off” when shooting outdoors or under lighting that does not cause flicker. (It can be also “Auto,” but the compensation may not be done properly.)
- It is recommended to set “Mode” to “Auto” when shooting indoors or under various lighting that may cause flicker, such as fluorescent, sodium, or mercury-vapor lamps. (If continuously shooting under lighting that may cause flicker, “Mode” should be set to “On.”)

The recommended “Mode” settings are shown below.

Flicker Reduce/Mode	Environments	
	Under lighting that may cause flicker	Under lighting that does not cause flicker
Auto	Recommended	Acceptable
On	Acceptable	Not recommended
Off	Not recommended	Recommended

## Setting the Time Data

Time data, such as the timecodes, user bits, and the clock time, are recorded with pictures.

### Running Modes of the Timecode

For the timecode, three running modes and Clock mode can be selected.

#### Rec Run mode

The timecode advances during recording only. The continuity of the timecode is maintained between clips in the sequence of recording as long as the SxS memory card is not changed. If you remove the memory card and record on another card, the timecode will not continue when you return the first card to the slot again.

#### Free Run mode

The timecode keeps advancing regardless of recording.

#### Regen mode

The timecode advances during recording only. When you insert another memory card, the camcorder starts next recording so that the timecode continues to the last recorded timecode on the card.

#### Clock mode

The current clock time is recorded for the timecode.

#### Note

- In Interval Recording, Frame Recording, Slow & Quick Motion Recording, the timecode advances in Rec Run mode regardless of the “Run” setting if you set “Mode” of “Timecode” to “Preset” with the TC/UB SET menu. If you set it to “Clock,” the timecode advances in Regen mode.
- When the Picture Cache function is active (P.Cache Rec Setting: On), the timecode always advances in Free Run mode. When the Picture Cache Rec function is deactivated, the running

mode selected with the TC/UB SET menu is restored.

## Setting the Timecode

Specify the timecode to be recorded with “Timecode” and “TC Format” of the TC/UB SET menu.

For details on menu operations, see “Basic Menu Operations” on page 115.

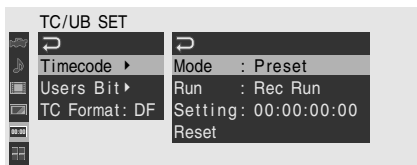

### Setting the timecode to a desired value

- 1 Set “Mode” of “Timecode” to “Preset.”
- 2 Specify the timecode value on the Setting line and select “SET.”

### Resetting the timecode

You can reset the timecode to be recorded in running modes to “00:00:00:00.”

- 1 Select “Reset” of “Timecode.”
- 2 Select “Execute.”

### Using the actual time as the timecode

#### Set “Mode” of “Time Code” to “Clock.”

The time of the built-in clock is recorded as the timecode.

### Switching between DF and NDF of the timecode

Using “TC Format” of the TC/UB SET menu, DF (drop-frame mode) and NDF (non-drop frame mode) of the timecode can be switched.

Note, however, that the mode is fixed either to DF or NDF regardless of the TC Format setting, depending on the current frame-rate setting.

## Restrictions on the timecode

The timecode setting is restricted by the current video format.

Video formats	Frame setting	TC Format
HQ 1920/60i	00 to 29	DF/NDF switchable
HQ 1440/60i		(Fixed to DF in
SP 1440/60i		Clock mode)
HQ 1920/30P		
HQ 1440/30P		
DVCAM60i SQ		
DVCAM60i EC		
DVCAM30P SQ		
DVCAM30P EC		
HQ 1920/50i	00 to 24	Fixed to NDF
HQ 1440/50i		
SP 1440/50i		
HQ 1920/25P		
HQ 1440/25P		
DVCAM50i SQ		
DVCAM50i EC		
DVCAM25P SQ		
DVCAM25P EC		
HQ 1920/24P	00 to 23 <sup>1)</sup>	Fixed to NDF <sup>2)</sup>
HQ 1440/24P		
HQ 1280/24P		
SP 1440/24P	00 to 29 <sup>3)</sup>	DF/NDF switchable
		(Fixed to DF in
		Clock mode)
HQ 1280/60P	00 to 29	DF/NDF switchable
(double		(Fixed to DF in
count)		Clock mode)
HQ 1280/50P	00 to 24	Fixed to NDF
(double		
count)		
HQ 1280/30P	00 to 29	DF/NDF switchable
		(Fixed to DF in
		Clock mode)
HQ 1280/25P	00 to 24	Fixed to NDF

1)The frame digits in “Setting” is limited to 00, 04, 08, 12, 16, and 20.

The frame at the beginning of recording is limited to 00, 04, 08, 12, 16, or 20.

As the SDI OUT connector output becomes 60i because of the 2-3 pull-down process except when “24P System” (page 125) is set to “24PsF” for 1920/24P in Camera mode, the frame digits of the timecode added to the SDI OUT connector output are changed to values in the range of 00 to 29.

2)Even in Clock mode, the timecode is gradually shifted, because it is counted by NDF.

As any output becomes 2-3 pulled-down video except those from the SDI OUT and COMPONENT OUT connectors with “24P System” (page 125) set to

“24PsF” for 1920/24P in Camera mode, there may be a field that has dual timecodes on the display.

3) With DF, the frame digits can be set as desired in the range of 00 to 29.

With NDF, the frame at the beginning of recording is limited to 00, 05, 10, 15, 20, or 25.

Display	Contents
TCG **.*.***.***	Timecode
CLK **.*.***.***	Timecode (Clock mode)
UBG **.*.***.***	User bits
DUR **.*.***.***	Duration from the beginning of recording

## Setting the User Bits

You can add a hexadecimal number of 8 digits for pictures as the user bits.

The user bits can also be set to the current date.

Use “Users Bit” of the TC/UB SET menu.

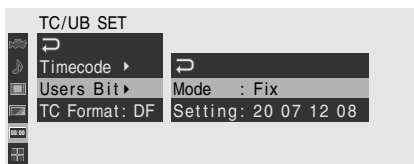

### Setting eight digits as desired

- 1 Set “Mode” of “Users Bit” to “Fix.”
- 2 Specify the values on the Setting line and select “SET.”

You can set hexadecimal digits A to F with the corresponding alphabets.

### Recording the current date as the user bits

Set “Mode” of “Users Bit” to “Date.”

The current date is displayed on the Setting line.

## Displaying the Time Data

In Camera mode, pressing the DISPLAY/BATT INFO button displays the time data on the screen.

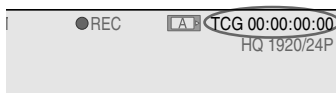

The indication is switched among the timecode, user bits, and recording duration each time you press the TC/U-BIT/DURATION button.

# Recording Audio Signals

Two channels (CH-1/CH-2) of audio can be recorded (Linear PCM recording) in synchronization with video recording. You can use the built-in stereo microphones (omni-directional electret condenser microphones) or 2-channel external audio inputs to the AUDIO IN connectors by switching with the AUDIO IN switches.

Recording

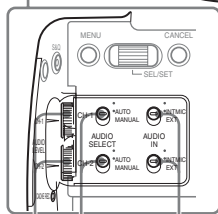
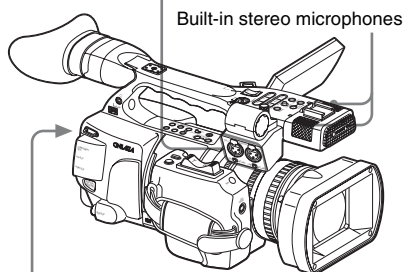
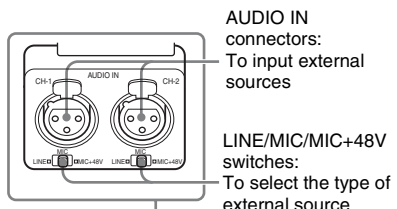

AUDIO LEVEL controls:  
To adjust the recording levels

## Using the Built-in Stereo Microphones

Set the AUDIO IN switches, both CH-1 and CH-2, to INT.

## Using External Inputs

- 1 Set the AUDIO IN switches CH-1 and CH-2 to EXT.
- 2 Connect external audio sources to the AUDIO IN connectors CH-1 and CH-2.
- 3 Set the LINE/MIC/MIC+48V switches CH-1 and CH-2 to LINE (line level: +4 dBu).

## Using an External Microphone

You can use an external microphone for recording, such as the ECM-673 Electret Condenser Microphone.

- 1 Loosen the screw of the microphone holder and open the cover.

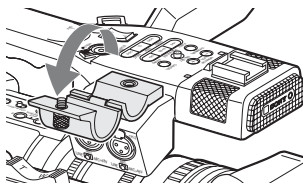

- 2 Attach a microphone, close the microphone holder cover for the original condition to secure, then connect the microphone cable to either of the AUDIO IN connectors (CH-1 or CH-2).

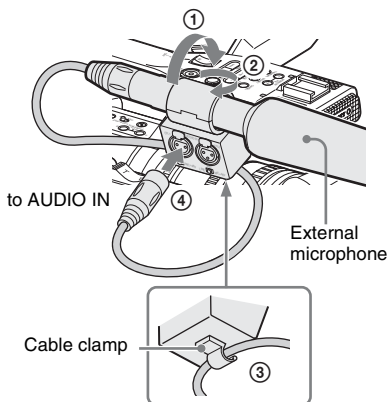

- 3 Set the corresponding **AUDIO IN switch (CH-1 or CH-2) to EXT.**
- 4 Set the corresponding **LINE/MIC/+48V switch (CH-1 or CH-2) according to the connected microphone.**

**MIC:** For a microphone that requires no power supply

**MIC +48V:** For a microphone that requires +48V power supply (such as the ECM-673)

#### Note

Even when recording CH-1 for 2-channel monaural by setting “EXT CH Select” of “Audio Input” (page 123) of the AUDIO SET menu to “CH-1,” set the LINE/MIC/MIC+48V switch for CH-2 to the same position as that for CH-1.

## Adjusting the Audio Recording Levels

You can select automatic or manual adjustment mode independently for each channel.

### To adjust the levels automatically (AGC)

When the AUDIO SELECT switches CH-1 and CH-2 are set to AUTO, the audio recording levels are automatically adjusted.

### To adjust the levels manually

Set the AUDIO SELECT switches CH-1 and CH-2 to MANUAL and adjust the audio recording levels by turning the AUDIO LEVEL controls. Set the controls to 5 for the reference setting (0 dB). Setting to 10 maximizes the level (+12 dB), and setting to 0 minimizes it ( $-\infty$ ). The input levels are displayed on the screen when you press the DISPLAY/BATT INFO button.

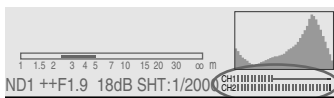

When you perform fine adjustment using “TRIM CH-1” and “TRIM CH-2” of “Audio Input” (page 123) of the AUDIO SET menu, set the AUDIO LEVEL controls to 5 and adjust the microphone sensitivity so that the appropriate meter indications are obtained.

### Audio recording in special recording modes

- No audio recording is made in Interval Recording or Frame Recording.
- No audio recording is made in Slow & Quick recording if the recording frame rate is set to a value different from the playback frame rate.

## Monitoring the Audio

You can monitor the sounds being recorded with the headphones connected to the headphone connector (stereo mini jack).

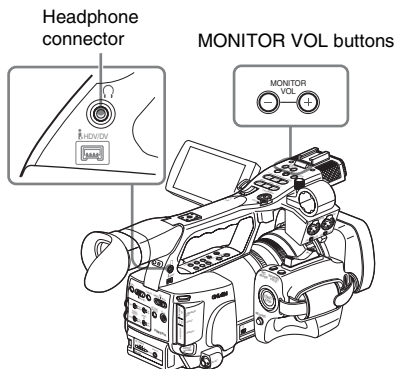

## Note

The built-in speaker is disabled in Camera mode.

### To adjust the audio monitoring volume

Use the MONITOR VOL buttons.

Pressing the + button increases the volume, and pressing the – button decreases it. To muffle the sound, set it to the minimum level.

While you adjust the volume, the level is displayed as a bar on the screen.

## Outputting the Color Bars and Reference Tone

The camcorder can output a color-bar signal in place of the camera picture.

A 1-kHz reference tone is output with the color bar signal if “1kHz Tone” of “Audio Input” (page 123) is set to “On” with the AUDIO SET menu. The color-bar signal and reference-tone signal are also fed out from the SDI OUT, COMPONENT OUT (color bars only), and A/V OUT connectors.

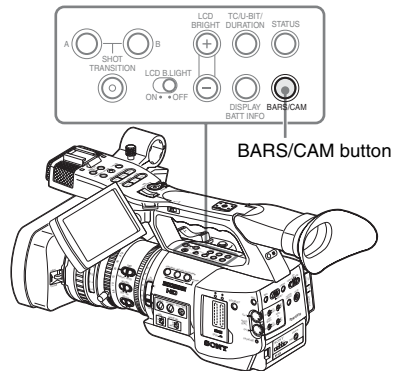

### Press the BARS/CAM button.

The camera picture is switched to color bars. To return to the camera picture, press the button again.

You can select the type of color bars with “Color Bar Type” (page 119) of the CAMERA SET menu.

**Multi:** ARIB multiformat color bars

**75%:** Vertical stripes of 75% luminance

**100%:** Vertical stripes of 100% luminance

## Notes

- When recording of the camera image is in progress, it cannot be switched to the color-bar picture even if you press the BARS/CAM button. (You can switch the color-bar picture to the camera picture.)
- The color bar mode cannot be selected in Slow & Quick Motion mode and EX Slow Shutter mode.

## Recording Shot Marks

When you record shot marks for important scenes of a clip recorded in HD Mode as subsidiary data, you can access the marked points easily on a Shot Mark screen, which only displays scenes with shot marks only. This increases editing efficiency.

For the Shot Mark screen, see “Displaying the SHOT MARK Screen (HD Mode Only)” on page 106.

The camcorder permits you to record two types of shot marks: shot mark 1 and shot mark 2. Shot marks can be recorded as needed during recording or can be added after recording while checking the playback pictures.

### Note

Shot marks cannot be recorded for clips recorded in SD Mode.

## Inserting a shot mark during recording

Activate the IR Remote Commander (page 33), and use the SHOTMARK 1 or 2 button.

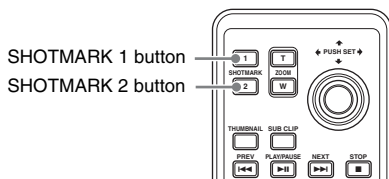

**Press the SHOTMARK 1 or 2 button where you wish to insert a mark.**

If the Shot Mark1 or Shot Mark2 function is assigned to an assignable button, you can also use it instead (page 69).

A shot mark of the type corresponding to the button you press is recorded.

For operations to add shot marks after recording, see “Adding Shot Marks During Playback (HD Mode)” on page 99 and “Adding/Deleting Shot Marks (HD Mode Only)” on page 107.

## Adding the OK Mark

By adding the OK mark to a clip recorded in HD Mode, you can prevent the clip from being deleted or divided inadvertently.

The OK mark is also used to obtain a thumbnail screen of only the marked clips (OK-Clip thumbnail screen) when you press the THUMBNAIL button.

For the OK-Clip thumbnail screen, see “Displaying the OK-Clip thumbnail screen (HD Mode)” on page 96.

### Note

The OK mark cannot be added to clips recorded in SD Mode.

To add the OK mark in Camera mode, assign the OK Mark function to an assignable button.

For function assignment, see “Changing Functions of the Assignable Buttons” on page 69.

## Adding the OK mark

In Camera mode, you can add the OK mark to the last clip recorded on the SxS memory card currently selected.

**When recording of a clip ends, press the assignable button to which you assigned the OK Mark function.**

The message “OK Mark” is displayed on the screen for three seconds.

## Deleting the OK mark

In Camera mode, you can delete the OK mark added to the last clip on the SxS memory card currently selected.

- 1 Press the assignable button to which you assigned the OK Mark function.**  
The confirmation message “Execute/Cancel” is displayed.
- 2 Select “Execute.”**  
The OK mark of the last clip is deleted.

## To add or delete the OK mark to or from clips before the last one

Operate in Media mode

See “Adding/Deleting the OK Mark to/from a Clip (HD Mode Only)” on page 103.

## Rec Review

You can review the last recorded clip on the screen (Rec Review).

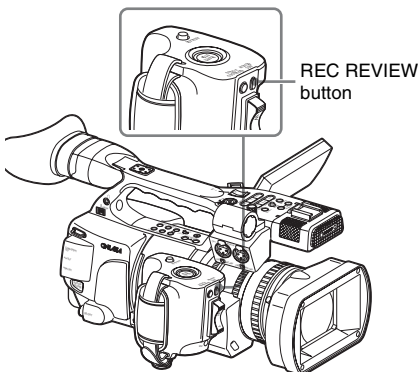

### Press the REC REVIEW button after recording is finished.

You can assign the Rec Review function to an assignable button to use it instead (*page 69*).

Playback of the specified block of the clip begins. In Rec Review, the last 3 seconds, 10 seconds, or the entire part of the clip is displayed, depending on the “Rec Review” setting (*page 120*) of the CAMERA SET menu. It is set to 3 seconds at the factory.

Rec Review is terminated at the end of the clip, resuming STBY (recording standby) status.

### To interrupt Rec Review

Press the REC REVIEW or STOP button or the assignable button to which you assigned the Rec Review function.

Rec Review is canceled, resuming STBY (recording standby) status.

### Notes

- If the duration of the last recorded clip is less than the time (3 or 10 seconds) specified for Rec Review, the clip is played back from the beginning to the end.  
If the clip was recorded in SD Mode and

segmented into multiple files because the file size exceeded 2GB, only the last file is played.

- During Rec Review playback, the playback control buttons other than the STOP button are disabled.
- If the video format was changed after recording, Rec Review cannot be performed (except when the change was from SP 1440/24P to SP 1440/60i).
- The Setup and PICTURE PROFILE menus cannot be operated during Rec Review.

## Changing Functions of the Assignable Buttons

The camcorder has four assignable buttons to which you can assign various functions for convenience.

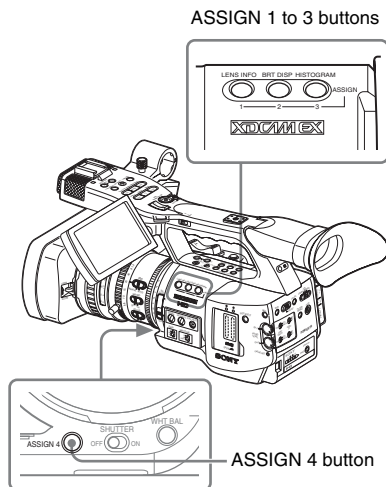

The following functions are assigned at the factory:

### **ASSIGN 1 button (LENS INFO)**

Depth-of-field indication on/off

### **ASSIGN 2 button (BRT DISP)**

Brightness-level indication on/off

### **ASSIGN 3 button (HISTOGRAM)**

Histogram indication on/off

### **ASSIGN 4 button**

No function is assigned (Off).

## Changing Functions

Use “Assign Button” of the OTHERS menu.

For details on menu operations, see “Basic Menu Operations” on page 115.

- 1 Select “Assign Button” from the OTHERS menu.**

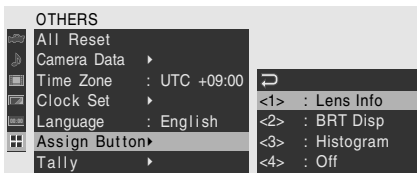

**2 Select the button to which you wish to assign a function.**

**3 Select the function to be assigned.**

Function	Contents
Marker	All marker indications (safety-zone marker, center marker, aspect marker, guide frames) on/off
Last Clip DEL	Last clip delete
ATW	ATW function on/off
ATW Hold	ATW Hold function on/off
Rec Review	Rec Review start/stop
Rec	Recording start/stop
Picture Cache	Picture Cache mode on/off
Freeze Mix	Freeze Mix start/stop
Expanded Focus	Expanded Focus function on/off
Spotlight	TLCS Spotlight mode on/off
Backlight	TLCS Backlight mode on/off
IR Remote	IR Remote Commander enable/disable
Shot Mark1 <sup>1)</sup>	Shot mark 1 insert
Shot Mark2 <sup>1)</sup>	Shot mark 2 insert
Fader	Fader on/off
EVF Mode	EVF screen mode (color/monochrome) switching
BRT Disp	Brightness level indication on/off
Histogram	Histogram indication on/off
Lens Info	Depth-of-Field indication on/off
OK Mark <sup>1)</sup>	OK Mark add/delete

<sup>1)</sup>Valid in HD Mode only

**4 Exit the menu.**

The assigned functions can be viewed on the **BUTTON/REMOTE** status screen (page 112).

## Interval Recording

The Interval Recording (time-lapse recording) function is especially effective for shooting objects that move very slowly.

The specified number of frames are automatically recorded at the specified intervals.

Recording interval (Interval Time)

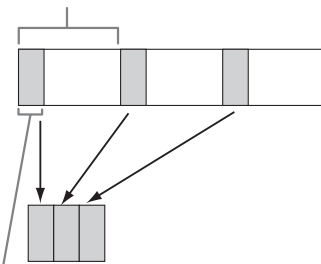

Number of frames for one recording session (Number of Frames)

It is recommended to fix the camcorder to a tripod or equivalent and use the IR Remote Commander to start/stop recording rather than pressing the **REC START/STOP** button of the camcorder.

### Notes

- Interval Recording cannot be set to “On” simultaneously with Frame Recording, Picture Cache Recording, or Slow & Quick Motion. When you set Interval Recording to “On,” Frame Recording, Picture Cache Recording and Slow & Quick Motion are forcibly set to “Off.”
- No audio recording is executed in Interval Recording.
- Interval Recording cannot be performed if an HD SP or SD video format is selected with “Video Format” and “i.LINK I/O” is set to “HDV” or “DVCAM” with the **OTHERS** menu.
- Interval Recording cannot be performed if “Video Format” of the **OTHERS** menu is set to SP 1440/24P.

## Preparatory Settings

Before starting Interval Recording, make the necessary settings on the CAMERA SET menu in advance.

For details on menu operations, see “Basic Menu Operations” on page 115.

### 1 Select “Interval Rec” of the CAMERA SET menu.

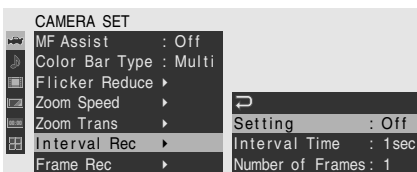

### 2 Set “Setting” to “On.”

The camcorder enters Interval Recording mode.

When the special recording mode indication on the screen is active, “Interval Rec” flashes on the screen.

### 3 Set the time between recordings with “Interval Time.”

You can select the time from among 1 to 10/15/20/30/40/50 seconds, 1 to 10/15/20/30/40/50 minutes, and 1 to 4/6/12/24 hours by scrolling the display.

### 4 Set the number of frames to be recorded at a time with “Number of Frames.”

When “Video Format” (page 132) is set to “HQ 1280/60P” or “HQ 1280/50P,” you can select from among 2, 6, and 12 frames. With other settings, you can select from among 1, 3, 6, and 9 frames.

### 5 Exit the menu.

## Performing Interval Recording

When the preparatory settings are completed, you can start recording.

### Press the REC START/STOP button.

Interval Recording begins.

The flashing “Interval Rec” on the screen is now steadily lit.

### Notes

- You cannot change the “Interval Time” and “Number of Frames” settings while Interval Recording is in progress. To change them, pause recording.
- After starting Interval Recording, Rec Review operation is disabled, even during an interval.
- The timecode is recorded in Rec Run mode (page 62) during Interval Recording.
- Some extra frames may be recorded if you stop recording or switch the card slot while recording is halted in Interval Recording mode.

## Stopping Interval Recording

### Press the REC START/STOP button.

Interval Recording stops.

To restart Interval Recording, press the button again.

## Canceling Interval Recording mode

Set “Setting” of “Interval Rec” of the CAMERA SET menu to “Off.”

### Note

It automatically returns to “Off” when you set the power switch to OFF, while the “Interval Time” and “Number of Frames” settings are maintained.

# Frame Recording

The Frame Recording function is especially effective for clay animation recording. The specified number of frames are recorded intermittently when you press the REC START/STOP button.

It is recommended to fix the camcorder to a tripod or equivalent and use the IR Remote Commander to start/stop recording rather than pressing the REC START/STOP button of the camcorder.

## Notes

- Frame Recording cannot be set to “On” simultaneously with Interval Recording, Picture Cache Recording or Slow & Quick Motion. When you set Frame Recording to “On,” Interval Recording, Picture Cache Recording and Slow & Quick Motion are forcibly set to “Off.”
- No audio recording is executed in Frame Recording.
- Frame Recording cannot be performed if an HD SP or SD video format is selected with “Video Format” and “i.LINK I/O” is set to “HDV” or “DVCAM” with the OTHERS menu.
- Frame Recording cannot be performed if “Video Format” of the OTHERS menu is set to SP 1440/24P.

## Preparatory Settings

Before starting Frame Recording, make the necessary settings on the CAMERA SET menu in advance.

For details on menu operations, see “Basic Menu Operations” on page 115.

### 1 Select “Frame Rec” of the CAMERA SET menu.



### 2 Set “Setting” to “On.”

The camcorder enters Frame Recording mode.

When the special recording mode indication on the screen is active, “Frame Rec” flashes on the screen.

### 3 Select the “Number of Frames” value for one recording session.

You can select from among 2, 6, and 12 when “Video Format” (page 46) is set to 720/60P or 720/50P.

With other video formats, you can select from among 1, 3, 6, and 9.

### 4 Exit the menu.

## Performing Frame Recording

When the preparatory settings are completed, you can start recording.

### 1 Press the REC START/STOP button.

Recording in Frame Rec mode begins. The “Frame Rec” indication stops flashing. When the number of frames you specified with the menu are recorded, the camcorder automatically enters FRM STBY (Frame Rec Standby) status.

### 2 Press the REC START/STOP button again.

Each time you press the REC START/STOP button, the camcorder records the specified number of frames then enters FRM STBY status.

## Notes

- Recording cannot be stopped until the specified number of frames are recorded. If the power switch is set to OFF during recording, the power is only shut off after the specified number of frames are recorded.
- The Rec Review function cannot be used while recording in Frame Rec mode is in progress.
- You cannot change the “Number of Frames” setting while recording in Frame Rec mode is in progress. To change it, pause the recording.
- The timecode is recorded in Rec Run mode (page 62) during Frame Recording.

- Some extra frames may be recorded if you stop recording or switch the card slot while recording is paused in Frame Rec mode.

## Stopping Frame Recording

### Set “Setting” of “Frame Rec” of the CAMERA SET menu to “Off.”

Recording stops and Frame Rec mode is canceled.

#### Note

It automatically returns to “Off” when you set the power switch to OFF, while the “Number of Frames” setting is maintained.

## Picture Cache Recording

When the Picture Cache function is active, the camcorder stores the last few seconds of video captured in the built-in cache memory to permit you to start recording video on an SxS memory card from a point before you press the REC START/STOP button.

The maximum picture cache time is 15 seconds.

#### Notes

- Picture Cache Recording cannot be set to “On” simultaneously with Frame Recording, Interval Recording, or Slow & Quick Motion. When you set Picture Cache Recording to “On,” Frame Recording, Interval Recording and Slow & Quick Motion are forcibly set to “Off.”
- The following operations set Picture Cache Recording to “Off.”
  - Setting Interval Recording to “On”
  - Setting Frame Recording to “On”
  - Setting Slow & Quick Motion to “On”
  - Changing the recording format
- When Picture Cache Recording is “On,” the time code is always recorded in Free Run mode regardless of the TC/UB SET menu settings (*page 61*).

## Preparatory Settings

Before starting Picture Cache Recording, make the necessary settings on the CAMERA SET menu in advance.

*For details on menu operations, see “Basic Menu Operations” on page 115.*

### 1 Select “P.Cache Rec” of the CAMERA SET menu.



### 2 Set “Setting” to “On.”

The Picture Cache Recording is enabled and the CACHE REC lamp lights.

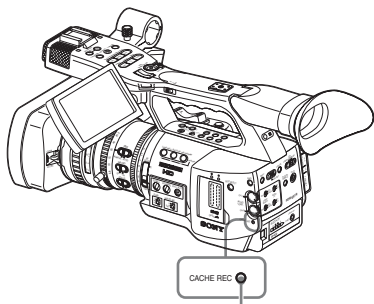

CACHE REC lamp

The Setting On/Off operation can be alternatively made by using an assignable button if you assign the Picture Cache function to the button.

*For function assignment, see “Changing Functions of the Assignable Buttons” on page 69.*

### 3 Set the time to cache video with “P.Cache Rec Time.”

You can select the time from among 0-2 sec, 2-4 sec, 4-6 sec, 6-8 sec, 8-10 sec, and 13-15 sec.

(The actual time to trace back to start recording may vary within the selected time range depending on conditions.)

### 4 Exit the menu.

The special recording/operation status indication block on the screen shows “●CACHE.” (● in green).

## Performing Picture Cache Recording

### Starting Picture Cache Recording

**Check that the CACHE REC lamp is lit and press the REC START/STOP button.**

Recording begins, and stored video in the cache memory is written first to the SxS memory card. The on-screen “●CACHE” indication changes the color of ● to red.

### Stopping Picture Cache Recording

**Press the REC START/STOP button.**

### Canceling Picture Cache function

Set “Setting” of “P.Cache Rec” of the CAMERA SET menu to “Off” or press the assignable button to which you assigned the Picture Cache function.

#### Notes

- If you change the recording format, the cached data are cleared and caching is newly started. Therefore, data cached before you changed the format cannot be recorded if you start Picture Cache Recording immediately after changing the format.
- If you start/stop Picture Cache Recording immediately after you insert an SxS memory card, data may not be recorded on the card.
- Picture caching starts when you activate the Picture Cache function. Therefore, video before the function is activated cannot be recorded with Picture Cache Recording.
- Picture Cache Recording is invalid for external input signal (HDV).
- As picture caching is disabled while an SxS memory card is being accessed, such as during playback, Rec Review, or thumbnail screen display, Picture Cache Recording of such a period cannot be made.
- Although you can change the “P.Cache Rec Time” setting on the menu even while recording is in progress, any new value becomes valid in such a case only after recording is stopped.

# Slow & Quick Motion Recording

When the camcorder is in HD Mode and one of the following video formats is selected (*page 44*), you can set a frame rate for recording different from that for playback:

## NTSC Area

HQ 1920/30P, HQ 1920/24P, HQ 1280/60P, HQ 1280/30P, HQ 1280/24P

## PAL Area

HQ 1920/25P, HQ 1280/50P, HQ 1280/25P

By recording at a different frame rate, you can obtain a smoother slow-motion or quick-motion effect than with slow-speed or fast-speed playback of a material recorded at the normal recording speed.

## Example

When the video format is HQ 1280/24P, recording with a frame rate between 1 and 23 fps provides a quick-motion effect in playback, and recording with a frame rate between 25 and 60 fps provides a slow-motion effect in playback.

## Notes

- Slow & Quick Motion cannot be activated in SD Mode.
- Slow & Quick Motion mode cannot be used if “i.LINK I/O” is set to “HDV” or “DVCAM” with the OTHERS menu.
- When you set Slow & Quick Motion to “On,” Frame Recording, Interval Recording, and Picture Cache Recording are forcibly set to “Off.” However, Slow & Quick Motion cannot be activated while Frame Recording, Interval Recording, or Picture Cache Recording is in progress.
- No audio recording is made if the recording frame rate is set to a value different from the playback frame rate.

## Preparatory Settings

Before starting Slow & Quick Motion recording, make the necessary settings with the CAMERA SET menu in advance.

For details on menu operations, see “Basic Menu Operations” on *page 115*.

- 1 Select “S&Q Motion” from the CAMERA SET menu.



- 2 Select the video for Slow & Quick Motion recording with “On Format.”
- 3 Select the frame rate for recording with “Frame Rate.”

The setting range varies depending on the current video format.

**With a format of 1920 horizontal**

**resolution:** 1 to 30 fps

**With a format of 1280 horizontal**

**resolution:** 1 to 60 fps

- 4 Exit the menu.
- 5 Press the S&Q button.

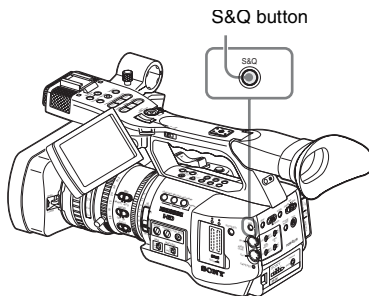

The camcorder enters Slow & Quick Motion mode.

When the special recording mode indication on the screen is active, “S&Q Motion” is displayed on the screen.

## Setting the recording frame rate with the Direct menu

When the special recording mode indication on the screen is active, [Recording frame rate/

[Playback frame rate] fps is displayed under “S&Q Motion.”

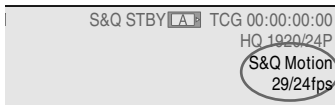

You can change the recording frame rate with the Direct menu by operating the joystick or the jog dial.

For details on the Direct menu, see “Direct Menu Operation” on page 24.

## Recording in Slow & Quick Motion Mode

### Starting recording

When the preparatory settings are completed, you can start recording.

#### Press the REC START/STOP button.

Slow & Quick Motion recording begins. Recording is made with the video format (On Format) and the frame rate (Frame Rate) set on the S&Q Motion menu.

#### Notes

- You cannot change the On Format and Frame Rate settings while Slow & Quick Motion recording is in progress. To change them, pause the recording.
- The timecode is recorded in Rec Run mode during Slow & Quick Motion recording (*page 61*).

### Stopping recording

#### Press the REC START/STOP button.

Slow & Quick Motion recording stops.

#### Note

When recording at a low-speed frame rate, it may take time until recording stops after you press the REC START/STOP button.

### Canceling Slow & Quick Motion mode

Press the S&Q button.

#### Note

Slow & Quick Motion mode is automatically canceled when you set the power switch to OFF, while the “On Format” and “Frame Rate” settings are maintained.

## Freeze Mix: Image Alignment

Using the Freeze Mix function, an image (still picture) of a clip recorded in HD Mode can be temporarily superimposed on the current camera picture, permitting you to easily align images for next recording.

---

### To use the Freeze Mix function

---

Assign the Freeze Mix function to one of the assignable buttons.

*For details, see “Changing Functions of the Assignable Buttons” on page 69.*

---

### Superimposing a Freeze Mix image

---

- 1 Stop recording to set the camcorder to STBY (recording standby) status.**
- 2 Press the REC REVIEW button to review the recorded images, or press the ASSIGN button to which you assigned “Freeze Mix.”**
- 3 Press the ASSIGN button to which you assigned “Freeze Mix” at the image with which you want align.**

The image where you pressed the ASSIGN button in step **3** is displayed as a still picture over the current camera picture.

---

### Canceling Freeze Mix status

---

You can cancel it with the ASSIGN button to which you assigned “Freeze Mix” or the REC START/STOP button.

- When you cancel Freeze Mix status by pressing the ASSIGN button, the normal camera picture is restored.
- When you cancel Freeze Mix status by pressing the REC START/STOP button, normal recording begins.

#### Notes

- The Freeze Mix function cannot be used in SD Mode.

- If the recorded picture and the current camera picture differ in video format, the Freeze Mix display cannot be achieved.
- The Freeze Mix function cannot be used if the recording video format is SP 1440/24P.
- The Freeze Mix display cannot be obtained in Slow & Quick Motion mode or Slow Shutter mode.
- You cannot operate the Setup menus and PICTURE PROFILE menu in Freeze Mix status.

## Shot Transition

The Shot Transition function helps you to easily obtain complex picture effects by registering camera settings or conditions as a “shot” to be reproduced in a recording sequence.

Your settings for focus, zoom, iris, gain, shutter speed, white balance, color matrix, and detail level can be registered in combination in one shot, and you can change the current camera settings to those of the shot, or the settings reproduced from one shot to those of another Shot, resulting in a smooth transition of scenes.

For example, you can shift the focus from a closer object to a farther object, or change the depth of field by adjusting the iris. In addition, you can develop scenes under different recording conditions smoothly. If you register the manual adjustment function for white balance, the scenes will develop smoothly between objects indoors and those outdoors.

### Notes

- Shot transition cannot be activated in combination with any of the EX Slow Shutter, Interval Recording, Frame Recording, and Slow & Quick Motion functions.
- If you wish to shift the focus in a shot transition, set the focus adjustment mode to MF or AF (see page 57). The focus will not be shifted if Full MF mode is selected.
- If you wish to shift the zoom in a shot transition, set the ZOOM switch to SERVO (see page 55). The zoom will not be shifted with the MANUAL setting.
- If you register a focus position in a macro area with the MACRO switch ON, the focus may not be shifted to the registered position if a shot transition is executed with the MACRO switch set to OFF.

### Shot-transition operation buttons and indications

For shot-transition operations, use the three TRANSITION operation buttons on the upper panel.

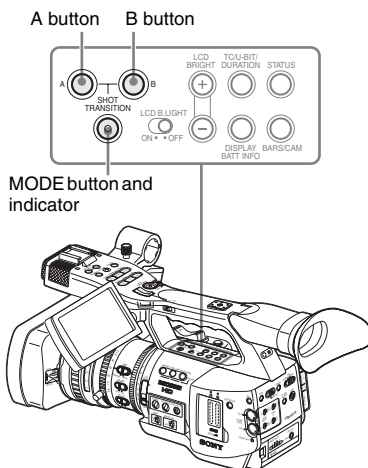

### A button and B button

You can register a Shot to each of the buttons.

### MODE button and indicator

When you press this button, the camcorder enters Shot Transition operation mode, and the indicator of the button lights.

The shot transition operation area is displayed on the screen.

Each time you press the button, the shot-transition operation mode cycles among Store, Check, Execute, and Off (normal Camera mode).

In Execute mode, the shot transition information area appears.

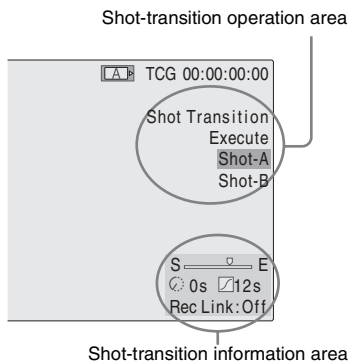

### Note

Camera operations are disabled when the shot transition operation mode is Check or Execute.

When adjustments are required, set the mode to Store.

## Preparatory Settings

Before you start recording using the Shot Transition function, make the necessary settings with the CAMERA SET menu in advance.

The conditions you set are indicated in the shot transition information area on the screen when you set the shot-transition operation mode to “Execute.”

### Shot-transition information area

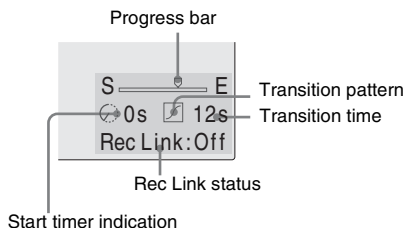

### Setting procedure

- 1 Select “Shot Transition” from the CAMERA SET menu.

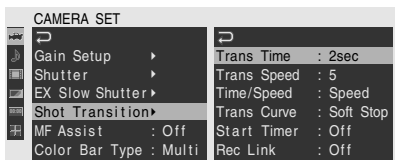

- 2 Specify the conditions for a shot transition.

#### Trans Time

After you set “Time/Speed” to “Time,” set the duration of a transition in the range of 2 to 15 sec in steps of 1 second.

#### Trans Speed

After you set “Time/Speed” to “Speed,” set the zoom transition speed (specifying the time to be taken for the zoom moving from the TELE end to the WIDE end at a certain speed).

The setting range is from 1 to 10. The larger the number you set, the higher speed.

### Time/Speed

Set whether to specify the duration of a transition by time or by speed of zoom transition.

Setting	Contents
Time	The “Transition Time” setting is valid.
Speed	The “Transition Speed” setting is valid.

### Trans Curve

Select the transition pattern.

The corresponding icon is displayed in the shot transition information area.

Setting and icon	Contents
------------------	----------

Linear  To make the transition linearly.

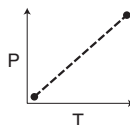

Soft Trans  To make the transition slowly at the beginning and end but linearly in between.

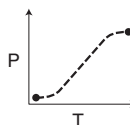

Soft Stop  To make the transition slowly near the end.

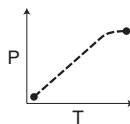

P: Parameter level T: Transition of time

### Start Timer

Set the time from start of recording to start of the shot transition.

The countdown indication is displayed in the shot-transition information area until the shot transition is started by the Start Timer.

### Rec Link

Set whether to link shot-transition start and target shot selection to recording start.

The setting status is displayed in the shot transition information area.

**Off:** Not to link to recording start

(To use the A or B button to start the transition and specify the target shot)

**Shot-A:** To start the transition to Shot A in synchronization with recording start

**Shot-B:** To start the transition to Shot B in synchronization with recording start

### 3 Exit the menu to finish the settings.

## Registering a shot

You can register two kinds of shots: A and B.

- 1 Press the **MODE** button to display “Store” in the shot-transition operation area.
- 2 Adjust the camera settings to obtain an image you wish to register.
- 3 When adjustment is finished, press the **Shot A** or **Shot B** button.

The camera settings are registered to the pressed button.

The registered camera settings are maintained until you register them next.

## Checking the Registered Settings (Shot)

- 1 Press the **MODE** button to display “Check” in the shot-transition operation area.
- 2 Press the **A** or **B** button, whichever you assigned to the shot you wish to check.

The selected shot (camera settings or conditions) takes effect on the picture on the screen.

With this operation, you cannot check the conditions of the transition.

## Recording with a Shot Transition

When the preparatory settings are completed, you can start recording.

Operations differ depending the “Rec Link” setting.

## Making a transition from the current picture to a registered shot

- 1 Adjust the camera settings to obtain an image with which you wish to start recording.
- 2 Press the **MODE** button to display “Execute” in the shot-transition operation area.
- 3 Press the **REC START/STOP** button.  
Recording begins.
- 4 When “Rec Link” is “Off,” press the button of the target shot (A or B) when you wish to start the shot transition.  
The current camera settings are gradually shifted to those registered to the specified shot.  
**When “Rec Link” is “Shot-A” or “Shot-B,”** the camcorder automatically performs the shot transition to the camera settings registered to Shot A or Shot B, respectively.  
You need not press the button.

### Notes

- You cannot return to the status in step 1 once after you start the shot transition. If the status must be resumed, register it as a shot.
- When you perform recording on an external device connected via the i.LINK(HDV/DV) connector in synchronization with REC START/STOP operations on this camcorder, recording start on the external device and shot-transition start may not be synchronized even if “Rec Link” has been set to “Shot-A” or “Shot-B,” depending on the performance of the external device.

## Making a transition from Shot A to Shot B

When “Rec Link” is set to “Off” or “Shot-B,” a shot transition from Shot A to Shot B is possible.

- 1 Press the **MODE** button to display “Check” in the shot-transition operation area.
- 2 Press the **A** button.  
The picture is adjusted according to the camera settings registered for Shot A.

- 3 Press the MODE button to display “Execute” in the shot-transition operation area.**
- 4 Press the REC START/STOP button.**  
Recording begins with the camera settings registered for Shot A.
- 5 When “Rec Link” is “Off,” press the B button when you wish to start the shot transition.**  
**When “Rec Link” is “Shot-B,”** the camcorder automatically performs the shot transition to the camera settings registered for Shot B. It is not necessary to press the B button.

---

### Making a transition from Shot B to Shot A

---

When “Rec Link” is set to “Off” or “Shot-A,” a shot transition from Shot B to Shot A is possible.

- 1 Press the MODE button to display “Check” in the shot-transition operation area.**
- 2 Press the B button.**  
The picture is adjusted according to the camera settings registered for Shot B.
- 3 Press the MODE button to display “Execute” in the shot-transition operation area.**
- 4 Press the REC START/STOP button.**  
Recording begins with the camera settings registered for Shot B.
- 5 When “Rec Link” is “Off,” press the A button when you wish to start the shot transition.**  
**When “Rec Link” is “Shot-A,”** the camcorder automatically performs the shot transition to the camera settings registered for Shot A. It is not necessary to press the A button.

---

### Ending recording

---

When recording is completed, press the REC START/STOP button.

### To cancel recording while a transition is in progress

If you press the REC START/STOP button during recording, the recording stops, even when a shot transition is in progress.

The E-E picture of the settings where the recording stops is displayed.

---

### Releasing a Shot Transition

---

Press the MODE button so that the button indicator goes dark.

The LCD monitor/EVF screen resumes the normal condition.

## Fader Function

Using the Fader function, you can start a recording by fading in a scene or end a recording by fading out of a scene.

The fader function can be assigned to an assignable button.

For function assignment, see “Changing Functions of the Assignable Buttons” on page 69.

### Notes

- The fader function cannot be used in combination with the Slow & Quick Motion, Interval Recording, Frame Recording, or EX Slow Shutter function.
- When a clip is recorded using the fade-in function, a white or black screen becomes the thumbnail image on the thumbnail screen (page 94). In HD Mode, changing the index frame may be useful for easier identification.
- When you perform recording on an external device connected via the i.LINK(HDV/DV) connector in synchronization with REC START/STOP operations on this camcorder, recording start/stop on the external device and fade-in start/fade-out end may not be synchronized, depending on the performance of the external device.

## Preparatory Settings

Specify the conditions to activate the Fader function in advance with the following procedure:

### 1 Select “Fader” of the CAMERA SET menu.



### 2 Specify the fade-in conditions.

#### Fade In

Set this to “On” to start recording with fade in.

(When you operate the function using an assignable button, it is not necessary to set “Fade In” to “On” with the menu.)

#### Fade In Type

Select the initial status of the fade-in.

**White:** To fade in from a white screen

**Black:** To fade in from a black screen

#### Fade In Time

Set the duration (1/2/3/5/10 sec) of fade-in.

### 3 Specify the fade-out conditions.

#### Fade Out

Set this to “On” to end recording with fade out.

(When you operate the function using an assignable button, it is not necessary to set “Fade Out” to “On” with the menu.)

#### Fade Out Type

Select the final status of the fade-out.

**White:** To fade out to a white screen

**Black:** To fade out to a black screen

#### Fade Out Time

Set the duration (1/2/3/5/10 sec) of fade-out.

### 4 Exit the menu.

- If you set “Fade In” to “On” with the menu, the camcorder enters Fade-in standby status when you exit the menu.
- When the Fader indication on the screen is active, the initial status (“White Fader” or “Black Fader”) you set with “Fade In Type” flashes.

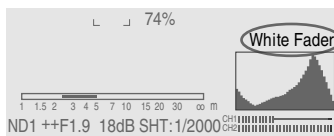

## When using an assignable button

If you assigned the Fader function to an assignable button, the Fade In/Fade Out On/Off settings can be made using the button.

### For fading in a scene

Press the ASSIGN button to which you assigned the Fader function in STBY (recording standby) status.

The fade-in function is turned on.

### For fading out

Press the ASSIGN button to which you assigned the Fader function during recording.

The camcorder enters in the fade-out standby status.

### Note

The Fade In/Fade Out settings automatically return to “Off” when you turn off the camcorder, while the Type and Time settings set with the menu are maintained.

## Starting Recording with a Fade In

When the preparatory settings are completed, you can start recording.

### Press the REC START/STOP button.

Recording begins by fading in the camera picture.

When the fade-in process you specified is completed, the camcorder enters Normal Recording mode.

The Fade-In Type indication flashes during the fade-in process and goes off when the process ends.

## Ending Recording with a Fade Out

- If you set “Fade Out” to “On” with the menu, the camcorder automatically enters Fade-out standby status when it is set to Recording mode.
- When you press the ASSIGN button to which you assigned the Fader function after starting recording, the camcorder enters fade-out standby status.

### Press the REC START/STOP button to start fading out of the camera picture.

The fading-out process begins.

When the fading-out process you specified is completed, recording simultaneously stops.

The Fade-Out Type indication flashes during the fade-out process and goes off when the process ends.

---

## Canceling the Fader function

---

Set “Fade In” and “Fade Out” to “Off” with the menu.

Or press the ASSIGN button again.

## Picture Profiles

You can customize the picture quality, depending on the conditions or circumstances of recording, and store them as a picture profile, enabling the picture quality to be resumed just by your selecting the picture profile.

Six different picture profiles (PP1 to PP6) can be stored in memory.

The same standard (reference) values are registered to six picture profiles at the factory as those specified for the Picture Profile Off status. The PICTURE PROFILE menu is available for picture-profile operations.

### Note

The picture profiles can be operated only in Camera mode. They cannot be operated in Media mode.

## Registering the Customized Settings as a Picture Profile

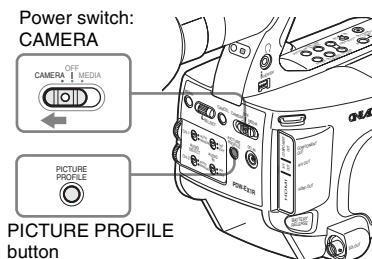

- 1 Set the power switch to **CAMERA** to turn the camcorder on in **Camera mode**.
- 2 Press the **PICTURE PROFILE** button. The **PICTURE PROFILE** menu is displayed.
- 3 Operating the jog dial or the joystick, select “**SEL**” from the **PICTURE PROFILE** menu then select the picture profile number (**PP1** to **PP6**) to operate.

PICTURE PROFILE	
SEL	OFF
SET	PP1: STANDARD
	PP2: STANDARD
	PP3: STANDARD
	PP4: STANDARD
	PP5: STANDARD
	PP6: STANDARD

- 4 Operating the jog dial or the joystick, select “**SET**” and make the settings of the picture profile items.

PICTURE PROFILE	
SEL	PP1:STANDARD
SET	⏪
	Profile Name
	Matrix ▶
	Color Correction ▶
	White ▶
	Detail ▶

For details on the setting items, see “Picture Profile Items” on page 87.

- 5 When the settings are completed, press the **PICTURE PROFILE** button to exit the menu.

## Selecting a Picture Profile

### Selecting a Picture Profile using the PICTURE PROFILE menu

Once you store a picture profile, you can call the picture quality registered in the picture profile as follows:

- 1 Set the power switch to **CAMERA** to turn the camcorder on in **Camera mode**.
- 2 Press the **PICTURE PROFILE** button. The **PICTURE PROFILE** menu is displayed.
- 3 Operating the jog dial or the joystick, select “**SEL**” then the desired picture profile from the list.

**Example:**

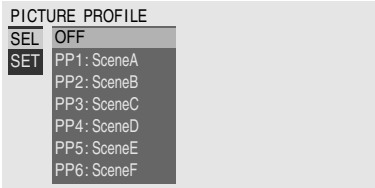

The camcorder is adjusted to the picture quality specified by the selected Profile. (If you select “OFF,” the camcorder will be fixed at the standard picture quality, and no picture adjustment is allowed.)

- 4 Press the PICTURE PROFILE button to exit the menu.**

### Selecting a Picture Profile using the Direct menu

The picture profile being selected is displayed when you press the DISPLAY/BATT INFO button.

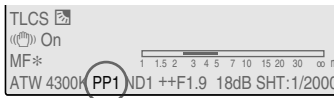

You can select picture profiles with the Direct menu by operating the joystick or the jog dial.

For details on the Direct menu, see “Direct Menu Operation” on page 24.

### Copying the Settings of a Picture Profile

You can copy the settings of a selected picture profile to another picture profile.

- 1 Select the source picture profile by proceeding from step 1 to 3 of “Selecting a Picture Profile using the PICTURE PROFILE menu” on page 84.**
- 2 Select “Copy” from “SET” of the PICTURE PROFILE menu.**

The picture profile numbers are listed on the screen.

- 3 Specify the target picture profile.**  
“Execute” and “Cancel” are displayed.
- 4 Select “Execute.”**  
Copying begins.

When copying ends, the completion message is displayed for three seconds, and the original screen display is restored.

### Resetting a Picture Profile

You can reset a selected picture profile to the factory settings (standard status).

- 1 Select the picture profile you wish to reset by proceeding from step 1 to 3 of “Selecting a Picture Profile using the PICTURE PROFILE menu” on page 84.**
- 2 Select “Reset” from “SET” of the PICTURE PROFILE menu.**  
“Execute” and “Cancel” are displayed.
- 3 Select “Execute.”**  
Resetting begins.

When resetting ends, the completion message is displayed for three seconds, and the original screen display is restored.

### Storing a Picture Profile on an SxS Memory Card

A picture profile can be sent to and stored on an SxS memory card as a file (filename: PPDATA.SUF).

Only one picture profile can be stored on the same memory card. The stored picture profile can be immediately reproduced by reading from the memory card.

### Storing a Picture Profile

- 1 Set the power switch to CAMERA.**  
The camcorder is turned on in Camera mode.
- 2 Insert a recordable SxS memory card into a slot.**

Confirm that the corresponding ACCESS lamp is lit in green.

### 3 Select the picture profile to be stored.

The selected picture profile number is displayed at the bottom of the screen.

See “Selecting a Picture Profile using the PICTURE PROFILE menu” on page 84.

### 4 Select “SET” of the PICTURE PROFILE menu.

### 5 Select “Store” of “PP Data.”

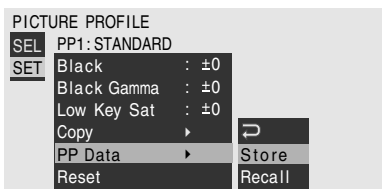

The message “PP Data Store Execute/Cancel” is displayed at the bottom of the screen.

### 6 Select “Execute.”

Writing of the selected picture profile to the memory card begins.

When writing ends, the completion message is displayed for three seconds, and the original screen display is restored.

#### Note

After you start writing, do not remove the SxS memory card until the completion message is displayed.

## Loading a Picture Profile

### 1 Set the power switch to CAMERA.

The camcorder is turned on in Camera mode.

### 2 Insert the SxS memory card that contains the picture profile to be loaded into a slot.

Confirm that the corresponding ACCESS lamp is lit in green.

### 3 Select the picture profile for which the picture profile is to be loaded from the memory card.

The selected picture profile number is displayed at the bottom of the screen.

See “Selecting a Picture Profile using the PICTURE PROFILE menu” on page 84.

### 4 Select “SET” of the PICTURE PROFILE menu.

### 5 Select “Recall” of “PP Data.”

The message “PP Data Recall Execute/Cancel” is displayed at the bottom of the screen.

### 6 Select “Execute.”

Loading of the picture profile from the memory card begins.

When overwriting to the picture profile you specified in step 3 ends, the completion message is displayed for three seconds, and the loaded settings are immediately reflected.

#### Note

After you start loading, do not remove the SxS memory card until the completion message is displayed.

## Picture Profile Items

The values when “Off” is selected at “SEL” of the PICTURE PROFILE menu are shown in bold face (example: **Standard**).

PICTURE PROFILE SET		
Items	Subitems and setting values	Contents
<b>Profile Name</b> Changing the picture profile name	Profile name	Set the profile name in 8 characters at maximum. You can use upper- and lowercase alphabets, numerics 0 to 9, - (hyphen), _ (underscore) and space.
	<b>Matrix</b> Adjusting the color phase over the entire area with matrix operations	Setting <b>On / Off</b>
	Select <b>Standard</b> /High SAT / FL Light / Cinema	Select the built-in preset matrix provided for convenience.
	Level -99 to +99 ( <b>±0</b> )	Adjust the color saturation for the entire picture area.
	Phase -99 to +99 ( <b>±0</b> )	Adjust the hue for the entire picture area.
	R-G, R-B, G-R, G-B, B-R, B-G -99 to +99 ( <b>±0</b> )	Finely adjust the color phase for the entire picture area by independently setting each of the factors.
<b>Color Correction</b> Adjusting the color phase in a specific area	Setting <b>On / Off</b>	Set to “On” to enable the color phase adjustment for a specific area. (Simultaneous adjustment of multiple areas is not allowed. You can adjust it for one area only.)
	Area Detection <sup>1)</sup> Execute/Cancel	Execute to detect the color in the center of the screen. The area centering around the detected color of the range specified by “Target Width” becomes the target area of Color Correction.
	Area Indication <sup>2)</sup> <b>On / Off</b>	Set to “On” to display the Zebra 1 pattern for the target area of Color Correction.
	Target Phase 0 to 359 ( <b>130</b> )	Manually adjust the center color for the target area for Color Correction.  <b>Note</b> When Area Detection is executed, this setting is overwritten by the Area Detection result. Perform fine adjustment with this item as required.
	Target Width 0 to 90 ( <b>40</b> )	Set the width of color phase for the target area for Color Correction.
	Level -99 to +99 ( <b>±0</b> )	Set the saturation for the color in the target area.
	Phase -99 to +99 ( <b>±0</b> )	Adjust the hue for the color in the target area.

**PICTURE PROFILE SET**

<b>Items</b>	<b>Subitems and setting values</b>	<b>Contents</b>
<b>White</b> Setting the white balance offset and the color temperature of the preset white	Offset White <b>On / Off</b>	Set to "On" to shift the conversion value for auto white balance in Memory A or B mode and that for auto tracing white in ATW mode to a lower color temperature or a higher color temperature.
	Offset<A> -99 to +99 ( <b>±0</b> )	Adjust the volume of the offset white (shifting volumes) of the conversion value in Memory A, Memory B, or ATW mode, respectively.
	Offset<B> -99 to +99 ( <b>±0</b> )	
	Offset<ATW> -99 to +99 ( <b>±0</b> )	
Preset White 2100 to 10000 ( <b>3200</b> )	Adjust the preset color temperature when Preset white balance mode is selected in steps of 100K.	
<b>Notes</b>		
<ul style="list-style-type: none"> <li>• Except when the white balance is in Memory A or B mode or when ATW is active, you cannot confirm the result of changing the Offset White and Offset settings on the screen.</li> <li>• Except when Preset white balance mode is selected, you cannot confirm the result of changing the Preset White settings on the screen.</li> </ul>		
<b>Detail</b> Adjusting the details to be applied to the picture in HD Mode	Setting <b>On / Off</b>	Set to "On" to apply the details to the video signal.
	Level -99 to +99 ( <b>±0</b> )	Adjust the detail level.
	Frequency -99 to +99 ( <b>±0</b> )	Set the center frequency of the details. Setting the center frequency higher decreases the details, and setting it lower increases the details.
	Crispening -99 to +99 ( <b>±0</b> )	Adjust the noise-suppression level. When you set it to a higher level, less noise may be seen, as fine elements of details are deleted leaving only high-level elements. When you set it to a lower level, fine elements are applied while increasing noise.
	H/V Ratio -99 to +99 ( <b>±0</b> )	Adjust the horizontal-to-vertical ratio of detail elements. A higher value makes the vertical elements increased with respect to the horizontal elements.
	White Limiter -99 to +99 ( <b>±0</b> )	Limit the white details.
	Black Limiter -99 to +99 ( <b>±0</b> )	Limit the black details.
	V DTL Creation NAM / Y / G / G+R	Select the source signal to generate vertical details from among NAM (G or R whichever is higher), Y, G, and G+R.
	Knee APT Level -99 to +99 ( <b>±0</b> )	Adjust the knee aperture level (level of details to be applied to the sections above the knee point).

**PICTURE PROFILE SET**

<b>Items</b>	<b>Subitems and setting values</b>	<b>Contents</b>
<b>SD Detail</b> Adjusting the details to be applied to the picture in SD Mode	Setting <b>On / Off</b>	Set to “On” to apply the details to the video signal.
	Level –99 to +99 ( <b>±0</b> )	Adjust the detail level.
	Frequency –99 to +99 ( <b>±0</b> )	Set the center frequency of the details. Setting the center frequency higher decreases the details, and setting it lower increases the details.
	Crispensing –99 to +99 ( <b>±0</b> )	Adjust the noise-suppression level. When you set it to a higher level, less noise may be seen, as fine elements of details are deleted leaving only high-level elements. When you set it to a lower level, fine elements are applied while increasing noise.
	H/V Ratio –99 to +99 ( <b>±0</b> )	Adjust the horizontal-to-vertical ratio of detail elements. A higher value makes the vertical elements increased with respect to the horizontal elements.
	White Limiter –99 to +99 ( <b>±0</b> )	Limit the white details.
	Black Limiter –99 to +99 ( <b>±0</b> )	Limit the black details.
	V DTL Creation NAM / <b>Y</b> / G / G+R	Select the source signal to generate vertical details from among NAM (G or R whichever is higher), Y, G, and G+R.
	Knee APT Level –99 to +99 ( <b>±0</b> )	Adjust the knee aperture level (level of details to be applied to the sections above the knee point).

PICTURE PROFILE SET		
Items	Subitems and setting values	Contents
<b>Skin Tone Detail</b> Adjusting the details to be applied to the areas of a specific color phase	Setting On / <b>Off</b>	Set to "On" to enable the detail level adjustment for specific color-phase areas. The detail level is uniform over the entire picture with the Off setting.
	Level -99 to +99 ( <b>±0</b> )	Adjust the skin-tone detail level.
	Area Detection <sup>1)</sup> Execute/Cancel	Execute to detect the color in the center of the screen. The area centering around the detected color becomes the target area for Skin Tone Detail control.
	Area Indication <sup>2)</sup> On / <b>Off</b>	Set to "On" to display the Zebra 1 pattern for the target area for Skin Tone Detail control.
	Saturation -99 to +99 ( <b>±0</b> )	Adjust the color (saturation) level for Skin Tone Detail control.  <b>Note</b> When Area Detection is executed, this setting is automatically returned to 0.
	Phase 0 to 359 ( <b>130</b> )	Adjust the center color-phase value for the target area for Skin Tone Detail control.  <b>Note</b> When Area Detection is executed, this setting is automatically changed to the value equivalent to that of the detected color.
	Width 0 to 90 ( <b>40</b> )	Adjust the width of the color phase of the target area for Skin Tone Detail control.  <b>Note</b> When Area Detection is executed, the Width setting automatically returns to 40.
<b>Knee</b> Adjusting the knee level	Setting On / <b>Off</b>	Set to "On" to compress the high-luminance area of the picture.  <b>Note</b> Knee is fixed and cannot be changed in the following cases: • When Gamma is set to CINE1 to 4 • When the electronic shutter is in SLS mode • When EX Slow Shutter is active
	Auto Knee On / <b>Off</b>	Set to "On" to automatically set the best knee conditions according to the luminance level of the picture. With "Off" the knee conditions can be manually adjusted independently of the luminance level of the picture.
	Point 50 to 109 ( <b>90</b> )	Set the knee point when Auto Knee is "Off."
	Slope -99 to +99 ( <b>±0</b> )	Set the knee slope (volume of compression) when Auto Knee is "Off."
	Knee SAT Level 0 to 99 ( <b>50</b> )	Adjust the knee saturation level for the area over the knee point.

PICTURE PROFILE SET		
Items	Subitems and setting values	Contents
<b>Gamma</b> Adjusting the gamma compensation level and selecting the gamma curve	Level –99 to +99 ( $\pm 0$ )	Adjust the gamma compensation level.
	Select <sup>3)</sup> STD1 / STD2 / <b>STD3</b> / STD4 / CINE1 / CINE2 / CINE3 / CINE4	Select the type of reference curve for gamma compensation.
<b>Black</b> Adjusting the black	–99 to +99 ( $\pm 0$ )	Adjust the master black level.
<b>Black Gamma</b> Adjusting the black gamma level	–99 to +99 ( $\pm 0$ )	Adjust the level of black gamma function that emphasizes only the dark areas of the picture to clear the tones or on the contrary de-emphasizes it to reduce noise.
<b>Low Key SAT</b> Adjusting the low key saturation	–99 to +99 ( $\pm 0$ )	Adjust the level of the low key saturation to heighten the colors only in the dark areas of the picture or pale them to reduce noise.
<b>Copy</b> Copying a picture profile	Execute / Cancel	Select “Execute” to copy.
<b>PP Data</b> Writing/loading a picture profile	Store	To store a picture profile on an SxS memory card.
	Recall	To load a picture profile from an SxS memory card.
<b>Reset</b> Resetting a picture profile	Execute / Cancel	Select “Execute” to reset.

1) To execute “Area Detection”

### 1. Select “Area Detection.”

A square marker that indicates the detection area appears in the center of the screen, and “Execute” and “Cancel” are displayed below.

### 2. Select “Execute.”

Color-phase detection in the marker area is performed.

When detection successfully ends, a completion message is displayed. Then the screen is restored, on which the target area for the Color Correction or Skin Tone Detail adjustment is changed to the area centering around the color detected by “Area Detection,” and the Area Indication (zebra pattern) appears.

If detection fails, an error message appears, then the precious screen is restored.

2) The Area Indication setting is common to all picture profiles PP1 to PP6.

3) Available gamma curves

STD1: This deemphasizes the contrast in dark areas more than STD2 and emphasizes the contrast in intermediate areas.

STD2: This deemphasizes the contrast in dark areas more than STD3.

STD3: Standard (factory setting)

STD4: This emphasizes the contrast in dark areas more than STD3.

CINE1: This smoothes the contrast in darker areas and accentuates gradation changes in brighter areas, for a calm and quiet effect.

CINE2: This gives almost the same results as CINE1. Select this when you wish to obtain 100% video signals for editing or other purposes.

CINE3: This emphasizes the contrast between light and dark more than CINE1 and CINE2, and also accentuates gradation changes on the black side.

CINE4: This emphasizes the contrast in dark areas more than CINE3. Contrast in dark areas is weaker and contrast in bright areas is stronger than STD curves.

## Deleting Clips

In Camera mode, the Last Clip DEL function for deleting the last recorded clip and the All Clips DEL function for deleting all clips from an SxS memory card are available.

For clip deletion in Media mode, see “Deleting Clips” on page 104.

### Deleting the Last Recorded Clip

Using the assignable button to which you assigned the Last Clip DEL function or the Setup menu, the last recorded clip is easily deleted.

#### To delete using the assignable button

Assign the Last Clip DEL function to one of the assignable buttons (see page 69) in advance.

- 1 **Press the assignable button to which you have assigned “Last Clip DEL.”**

A confirmation message is displayed.

- 2 **Operating the joystick or the jog dial, select “Execute.”**

The last recorded clip is deleted from the memory card.

#### To delete using the Setup menu

- 1 **Select “Last Clip DEL” from “Clip” of the OTHERS menu.**

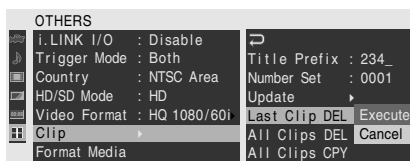

- 2 **Select “Execute.”**

A confirmation message is displayed.

- 3 **Select “Execute” again.**

The last recorded clip is deleted from the memory card.

For details on menu operations, see “Basic Menu Operations” on page 115.

### Deleting Clips Collectively

Using the Setup menu, you can delete the recorded clips collectively from the SxS memory card in the selected card slot.

- 1 **Select “All Clips DEL” from “Clip” of the OTHERS menu.**

- 2 **Select “Execute.”**

A confirmation message is displayed.

- 3 **Select “Execute” again.**

All the clips are deleted from the memory card.

#### Notes

- If the SxS memory card contains clips of both of HD Mode and SD Mode, only the clips of the currently selected mode are deleted.
- Clips with the OK mark applied cannot be deleted.

For details on the OK mark, see “Adding/Deleting the OK Mark to/from a Clip (HD Mode Only)” on page 103.

# Storing/Retrieving the Setting Data

You can store all the menu settings (including picture profiles) as a setup file on an SxS memory card.

By retrieving the stored setup file, the proper setup condition can be immediately obtained. For the setup file operations, use “Camera Data” of the OTHERS menu.

## Note

The Clock Set, Time Zone, Hours Meter (page 130) values are excluded.

## Storing the Setup File

Only one setup file can be stored on one SxS memory card.

### 1 Insert a memory card on which you wish to store the setup file to a card slot.

Check that the corresponding memory card icon is displayed on the screen. If a memory card in the other slot is selected, press the SLOT SELECT button to switch.

### 2 Select “Camera Data” from the OTHERS menu.

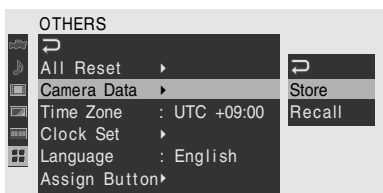

### 3 Select “Store.”

“Cancel” and “Execute” appear to the right.

### 4 Select “Execute.”

Writing of data to the memory card begins. An in-progress message is displayed during writing. When writing is completed, a completion message is displayed.

## Notes

- If a setup file already exists on the memory card you specified in Step 1, a message to confirm whether to overwrite the file is displayed.
- If there is not sufficient space on the memory card, an error message is displayed.

## Retrieving the Setup File

When you retrieve the stored setup file, the camcorder settings are changed according to the file.

### 1 Insert the memory card on which you stored the setup file into a card slot.

Check that the corresponding memory card icon is displayed on the screen. If a memory card in the other slot is selected, press the SLOT SELECT button to switch.

### 2 Select “Camera Data” from the OTHERS menu.

### 3 Select “Recall.”

“Cancel” and “Execute” appear to the right.

### 4 Select “Execute.”

Reading of data from the memory card begins. An in-progress message is displayed during data reading. When the read-out is completed, a completion message is displayed, indicating that the camcorder settings have been changed according to the setup file.

## Resetting to the Standard Values

The current camcorder settings you made through various menu and button operations can be collectively returned to the standard statuses (factory settings) by executing “All Reset” of the OTHERS menu.

# Thumbnail Screens

Turning the camcorder on with the power switch set to MEDIA sets it to Media mode, and the clips recorded on the SxS memory card are displayed as thumbnails on the screen. (If no clips are recorded on the card, a no-clip message is displayed.)

You can start playback from the clip selected on the thumbnail screen.

The playback picture can be seen on the LCD monitor/EVF and external monitors.

For connection of external monitors, see “Connecting External Monitors” on page 135.

**Note**

Even if the SxS memory card contains clips of both HD and SD Modes, the normal thumbnail screen shows only clips of the mode being selected at “HD/SD Mode” of the OTHERS menu (page 45).

To display all recorded clips regardless of the mode, switch the screen to the All-Clip thumbnail screen (page 96). Note that you cannot start playback from the All-Clip thumbnail screen.

## Configuration of the Thumbnail Screen

### HD Mode

The icon of the current SxS memory card is highlighted, shading the nonselected one. (If the card is write-protected, a lock icon is displayed to the left.)



The index frame images of the clips are displayed as thumbnails.

The first frame is automatically specified as the index frame of a clip when recorded. You can change it to another one as required (see page 108).

The recording date and starting time are displayed below the index image of each clip. (The OK mark symbol is displayed if the clip is marked.)

Data for the clip at the cursor are displayed in 1 to 8.

**1. Date and starting time of recording**

## 2. Clip name

## 3. OK mark

Displayed only if the selected clip is marked OK (page 103).

## 4. AV independent file icon

Displayed if the selected clip is an AV independent file. This indicates that the clip is an AV independent file, such as those added to the memory card using a computer. Not all operations and indications may be available for such clips.

## 5. Recording video format

## 6. Duration of the clip

## 7. Timecode

The timecode of the index frame is displayed.

## 8. Special recording information

If the selected clip was recorded in a special recording mode (S&Q Motion, Interval Rec, or Frame Rec), the mode is displayed.

For a clip recorded in S&Q Motion mode, [recording frame rate/playback frame rate] fps is displayed to the right.

## SD Mode

The icon of the current SxS memory card is highlighted, shading the nonselected one. (If the card is write-protected, a lock icon is displayed to the left.)

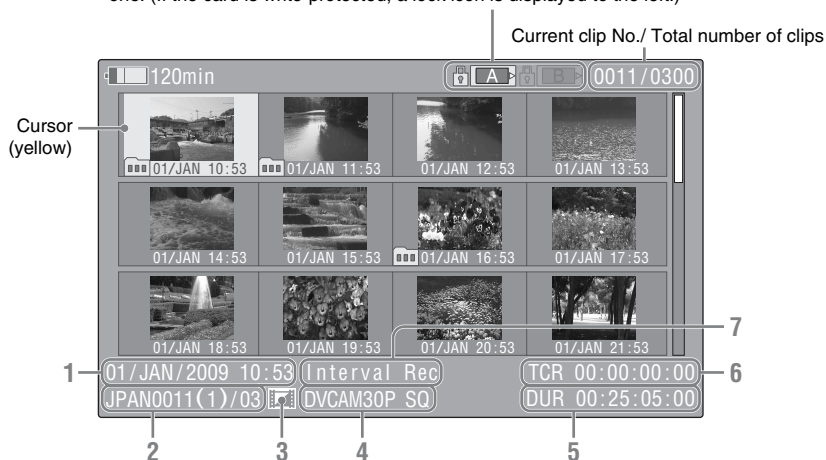

The top frame images of the clips are displayed as thumbnails.

The recording date and starting time are displayed below the top frame image of each clip.

For the clips segmented into multiple files because their file size exceeded 2GB, a  symbol is displayed.

You can check the segment files on the EXPAND CLIP screen (page 106).

Data for the clip at the cursor are displayed in 1 to 7.

### 1. Date and starting time of recording

### 2. Clip name

Only if the selected clip is a segmented one as its file size is over 2GB, the number of

partitions is displayed after the name, separated with a slash.

### 3. AV independent file icon

Displayed if the selected clip is an AV independent file. This indicates that the clip is an AV independent file, such as those added to the memory card using a computer. Not all operations and indications may be available for such clips.

### 4. Recording video format

### 5. Duration of the clip

### 6. Timecode

The timecode of the index frame is displayed.

### 7. Special recording information

If the selected clip was recorded in a special recording mode (Interval Rec or Frame Rec), the mode is displayed.

## Changing the Type of Thumbnail Screen

The type of thumbnail screen can be changed by pressing the THUMBNAIL button.

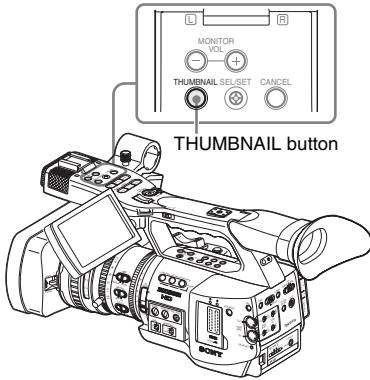

### In HD Mode

Each time you press the button, the normal thumbnail screen, OK-Clip thumbnail screen, and All-Clip thumbnail screen are cyclically displayed.

### In SD Mode

Each time you press the button, the normal thumbnail screen and All-Clip thumbnail screen are alternately displayed.

## Displaying the OK-Clip thumbnail screen (HD Mode)

The OK-Clip thumbnail screen shows only the clips marked OK among the clips on the current SxS memory card.

Pressing the THUMBNAIL button with the normal thumbnail screen displayed displays the OK-Clip thumbnail screen.

*For operations of the OK mark in Camera mode, see "Adding the OK Mark" on page 67.*

*For operations of the OK mark in Media mode, see "Adding/Deleting the OK Mark to/from a Clip (HD Mode Only)" on page 103.*

## Displaying the All-Clip thumbnail screen

The All-Clip thumbnail screen shows all clips both of HD and SD Modes recorded on the current SxS memory card, permitting you to

check whether the card contains any clips of another mode than that currently selected.

In HD Mode, pressing the THUMBNAIL button with the OK-Clip thumbnail screen displayed displays the All-Clip thumbnail screen.

In SD Mode, pressing the THUMBNAIL button with the normal thumbnail screen displayed displays the All-Clip thumbnail screen.

### Note

You cannot start playback from the All-Clip thumbnail screen.

Press the THUMBNAIL button again to return to the normal thumbnail screen, and playback and clip operations are enabled.

## Switching the SxS memory cards

When two memory cards are loaded, press the SLOT SELECT button to switch memory cards.

### Note

In Media mode, card switching is enabled only when the thumbnail screen is displayed or when an external input picture is displayed by pressing the STOP button.

You cannot switch memory cards during playback.

Continuous playback of cards in slots A and B is not possible.

## Playing Back Clips

For playback operations, use the playback control buttons on the handle.

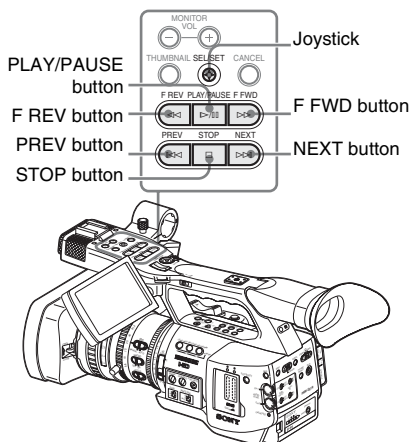

- When the IR Remote Commander is enabled, you can use its playback control buttons instead (see page 33).
- Functions of the playback control buttons are occasionally assigned to the joystick (see page 98).
- The jog dial is also valid when you move the cursor on the thumbnail screen or proceed to the next step of operations.

### Playing Back the Selected and Subsequent Clips in Sequence

- 1 Operating the joystick or jog dial, move the cursor to the thumbnail image of the clip with which you wish to start playback.**
- 2 Press the PLAY/PAUSE button.**  
Playback starts from the beginning of the selected clip.

The clips after the selected clips are played back in sequence.

When playback of the last clip ends, the camcorder enters PAUSE (still picture) mode at the last frame of the last clip.

Press the THUMBNAIL button to return to the thumbnail screen.

#### Notes

- The playback picture may be momentarily distorted or frozen between clips. The playback control buttons and THUMBNAIL button do not function during this condition.
- When you select a clip on the thumbnail screen and start playback, the playback picture at the beginning of the clip may be distorted. To start playback without distortion, once pause playback after starting it, press the PREV button to return to the top of the clip, then restart playback.

#### Information displayed on the playback screen

The following information is superimposed on the playback picture.

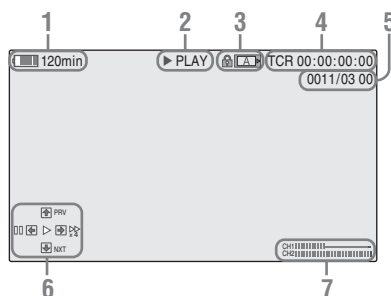

- 1. Battery remaining/DC IN voltage**
- 2. Playback mode**
- 3. SxS memory card in use**  
A mark appears if the memory card is write-protected.
- 4. Time data**  
The time data for the playback picture are displayed. Each time you press the TC/U-BIT/DURATION button, the indication is switched between timecode (TCR) and user-bit (UB) data.

## 5. Clip no./total number of clips on the memory card

## 6. Joystick operation guidance area

The functions assigned to the joystick in the current condition are displayed.

**Display example (Playback mode):**

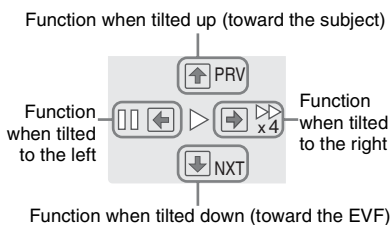

Guide marks	Functions
▶▶	High-speed playback in forward direction (×4, ×15, ×24)
◀◀	High-speed playback in reverse direction (×4, ×15, ×24)
▶	Normal playback
⏸	Pause
PRV	Jump to the top of the current clip
NXT	Jump to the top of the next clip

## 7. Audio levels

The audio levels in recording are displayed.

### Pausing the playback

Press the PLAY/PAUSE button.

The playback is restarted by pressing the button again.

### Stopping playback

You can stop playback with either of the following operations:

#### Press the THUMBNAIL button.

Playback mode is canceled, restoring the thumbnail screen.

#### Press the STOP button.

Playback mode is canceled, showing any external input or a blue screen.

To display the thumbnail screen, press the THUMBNAIL button.

## Monitoring Audio

In Normal playback mode, you can monitor the recorded audio signals through the built-in speaker or connected headphones.

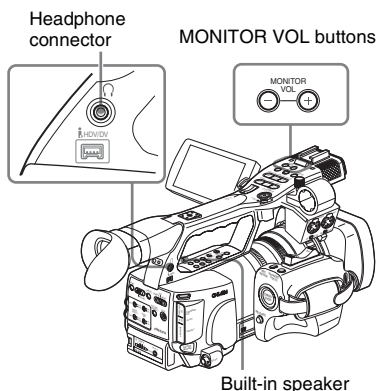

With the headphones connected to the headphone jack, the built-in speaker is turned off.

Press the MONITOR VOL buttons to adjust the sound volume.

The level bar is displayed during adjustment.

You can select audio channel(s) to be monitored with “Audio Output” (page 123) of the AUDIO SET menu.

## Switching to High-Speed Playback

The camcorder permits you to play clips at 4 times, 15 times or 24 times normal speed in the forward or reverse direction. Audio is muffled in 15-time or 24-time high-speed playback.

#### To play at a high speed in the forward direction

Press the F FWD button.

Each time you press the button, the playback speed switches among 4 times, 15 times and 24-times normal speed.

#### To play at a high speed in the reverse direction

Press the F REV button.

Each time you press the button, the playback speed switches between 4 times, 15 times and 24 times normal speed.

#### To return to normal playback

Press the PLAY/PAUSE button.

## Cueing Up

### To return to the top of the current clip

Press the PREV button.

- When you press the button in normal or fast-forward playback, the top of the current clip is cued up then playback begins.
- When you press the button in fast-reverse playback or in Pause mode, the top of the current clip is cued up, then the still picture is displayed.
- Repeated pressing of the button cues up the previous clips one by one.

### To start playback from the top of the first clip

Press the PREV button and F REV button simultaneously. The top of the first-recorded clip on the memory card is cued up.

### To jump to the top of the next clip

Press the NEXT button.

- When you press the button in normal or fast-forward playback, the top of the next clip is cued up then playback begins.
- When you press the button in fast-reverse playback or in Pause mode, the top of the next clip is cued up, then the still picture is displayed.
- Repeated pressing of the button cues up the subsequent clips one by one.

### To start playback from the top of the last clip

Press the F FWD button and NEXT button simultaneously. The top of the last-recorded clip on the memory card is cued up.

## Adding Shot Marks During Playback (HD Mode)

In the same manner as in recording, you can add shot marks to the clip during playback.

**At the point where you wish to add a shot mark, press the “Shot Mark1” or “Shot Mark2” assigned button, or the SHOTMARK 1 or 2 button on the IR Remote Commander.**

### Notes

- No shot mark can be added if the memory card is write-protected.
- No shot mark can be added to the first or last frame of a clip.

# Clip Operations

In Media mode, you can operate the clips or confirm and change the subsidiary data for clips using the Clip Operation menus.

The corresponding Clip Operation menu pops up on the screens as shown below.

## Clip Operation Menus

### Thumbnail screen (page 101)

- CANCEL
- DISP CLIP INFO
- OK MARK ADD
- OK MARK DEL
- COPY CLIP
- DELETE CLIP
- SHOT MARK
- SHOT MARK1
- SHOT MARK2
- EXPAND CLIP

### Still picture in Pause mode (page 101)

- CANCEL
- DISP CLIP INFO
- OK MARK ADD
- SHOT MARK1 ADD
- SHOT MARK2 ADD
- EXPAND CLIP

### EXPAND CLIP screen (page 106)

- CANCEL
- EXPAND (COARSE)
- EXPAND (FINE)
- PAUSE
- SET INDEX PIC
- SHOT MARK1 ADD
- SHOT MARK2 ADD
- SHOT MARK1 DEL
- SHOT MARK2 DEL
- DIVIDE CLIP

### SHOT MARK screen (page 107)

- CANCEL
- PAUSE
- SET INDEX PIC
- SHOT MARK1 DEL
- SHOT MARK2 DEL
- DIVIDE CLIP

#### Note

Selectable menu items are limited in SD Mode.

## Basic Operations of the Clip Operation Menus

### Displaying a Clip Operation menu

Press the joystick or the jog dial.  
The Clip Operation menu for the current display pops up.

### Selecting a Clip Operation menu item

Turn the jog dial or tilt the joystick to select a menu item then press the jog dial or the joystick. Pressing the CANCEL button restores the previous condition.

Selecting “CANCEL” from a Clip Operation menu turns the Clip Operation menu off.

#### Notes

- When the SxS memory card is write-protected, you cannot copy/delete/divide clips, change the index frames, and add/delete the OK and shot marks.
- There may be items that cannot be selected depending on the status when the menu is displayed.

### Clip Operation menu on the thumbnail screen

Pressing the joystick or the jog dial with the thumbnail screen (page 94) displayed calls the Clip Operation menu for the clip at the cursor.

Item	Function
DISP CLIP INFO	To display the CLIP INFO screen for the clip (page 102)
OK MARK ADD <sup>1)</sup>	To add the OK mark to the clip (page 103)
OK MARK DELETE <sup>1)</sup>	To delete the OK mark from the clip (page 103)
COPY CLIP	To copy the clip to another SxS memory card (page 103)
DELETE CLIP	To delete the clip (page 104)
SHOT MARK <sup>1)</sup>	To display thumbnails only of the frames with shot mark 1 and/or shot mark 2 recorded (page 106)
SHOT MARK <sup>1)</sup>	To display thumbnails only of the frames with shot mark 1 recorded (page 106)

Item	Function
SHOT MARK <sup>2)</sup>	To display thumbnails only of the frames with shot mark 2 recorded (page 106)
EXPAND CLIP	To display the EXPAND CLIP screen (page 105) for the clip

<sup>1)</sup>Effective in HD Mode only. You cannot select in SD Mode.

### Clip Operation menu in Pause mode

Pressing the joystick or the jog dial with a still picture displayed in Pause mode calls the Clip Operation menu for the clip in Pause mode.

Item	Function
DISP CLIP INFO	To display the CLIP INFO screen for the clip (page 102)
OK MARK ADD <sup>1)</sup>	To add the OK mark to the clip (page 103)
SHOT MARK1 ADD <sup>1)</sup>	To add shot mark 1 (page 106)
SHOT MARK2 ADD <sup>1)</sup>	To add shot mark 2 (page 106)
EXPAND CLIP	To display the EXPAND CLIP screen (page 105) for the clip

<sup>1)</sup>Effective in HD Mode only. You cannot select in SD Mode.

## Displaying the Detailed Information of a Clip

When you select “DISP CLIP INFO” from a Clip Operation menu, the CLIP INFO screen appears.

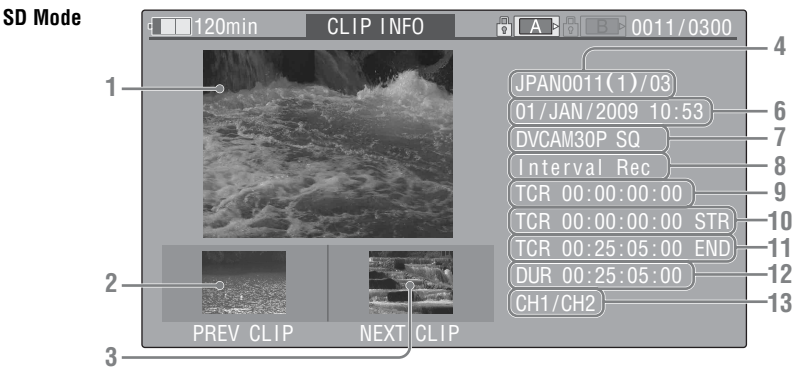

### 1. Image of the current clip

### 2. Image of the previous clip

Press the PREV button to switch to the CLIP INFO screen of the previous clip.

### 3. Image of the next clip

Press the NEXT button to switch to the CLIP INFO screen of the next clip.

### 4. Clip name

In SD Mode, the number of partitions is displayed after the name only if the selected clip is a segmented one because its file size is over 2GB.

For a clip name of 12 characters or longer, only the first 5 and last 5 characters of the name are displayed. To check the non-displayed block of the name, press the jog dial or joystick to display

the entire clip name (Long-Display mode). Press the jog dial or the joystick again to cancel Long-Display mode. Long-Display mode is also canceled by switching to the previous or next clip with the PREV or NEXT button.

### 5. OK mark (HD Mode only)

Displayed only when the selected clip is marked OK.

### 6. Date and starting time of recording

### 7. Recording format

### 8. Special recording information

If the selected clip was recorded in a special recording mode, S&Q Motion (HD Mode only), Interval Rec, or Frame Rec, the mode is displayed.

For a clip recorded in S&Q Motion mode, [recording frame rate/playback frame rate] fps is displayed to the right.

9. **Timecode of the displayed frame**
10. **Timecode at the recording starting point**
11. **Timecode at the recording ending point**
12. **Duration of the clip**
13. **Recorded audio channels**

## Adding/Deleting the OK Mark to/from a Clip (HD Mode Only)

By adding the OK mark to clips, you can obtain a thumbnail screen of only the marked clips when you press the THUMBNAIL button. Clips with the OK mark cannot be deleted or divided. To delete or divide the clip, remove the OK mark.

### Adding the OK mark

#### 1 Select “OK MARK ADD” from the Clip Operation menu.

The CLIP INFO screen for the clip appears and a confirmation message appears below the index frame.

#### 2 Select “Execute,” and press the jog dial or the joystick.

The OK mark is applied to the selected clip.

### Deleting the OK mark

For a clip already marked with OK, the Clip Operation menu of the thumbnail screen permits you to select “OK MARK DEL.”

#### 1 Select “OK MARK DEL” from the Clip Operation menu.

The information screen for the selected clip appears, and a confirmation message is displayed below the index frame image.

#### 2 To delete, select “Execute” then press the jog dial or the joystick.

The OK mark is deleted from the selected clip.

## Copying Clips

You can copy clips on an SxS memory card to another SxS memory card. Each clip is copied with the same name to the destination SxS memory card.

### Notes

- If there is another clip having the same name on the destination SxS memory card, the clip is copied under a name adding a single-digit number in parentheses to the end of the original clip name. The parenthetical number is the minimum value that does not exist in the destination memory card.  
**Examples:**  
ABCD0002(1) if ABCD0002 exists  
ABCD0002(2) if ABCD0002(1) exists  
ABCD0005(4) if ABCD0005(3) exists
- If parenthetical numbers (1) to (9) already exist as the result of repeated copying, copying to that card cannot be done any more.
- A warning message is displayed if there is not sufficient space on the destination SxS memory card. Replace the SxS memory card with one with sufficient space.
- When copying an SxS memory card on which multiple clips have been recorded, copying all clips to the end may not be achieved, even if the destination card has the same capacity as the source card, depending on usage conditions, memory characteristics, etc.

### Copying a specified clip

You can copy a clip selected on the thumbnail screen to another SxS memory card.

#### 1 On the thumbnail screen of the current memory card, select the clip you wish to copy then press the joystick or the jog dial.

The Clip Operation menu of the thumbnail screen pops up.

#### 2 Select “COPY CLIP” from the Clip Operation menu.

The information screen of the selected clip appears, and a confirmation message is displayed below the index frame image.

### 3 To copy, select “Execute” then press the jog dial or the joystick.

Copying begins.

An execution message and an in-progress bar are displayed during copying.

When copying ends, the thumbnail screen is restored.

#### To cancel copying on the way

Press the CANCEL button.

Copying is canceled and the thumbnail screen is restored.

### Copying clips collectively

By using the Setup menu, you can copy clips on an SxS memory card collectively to another SxS memory card.

If the memory card contains clips of both HD and SD Mode, only the clips of the currently selected mode are copied. This may be convenient when you wish to extract clips of the same mode only.

- 1 Press the MENU button when the normal thumbnail screen is displayed or in the Stop status.
- 2 Select “All Clips CPY” from “Clip” of the OTHERS menu.

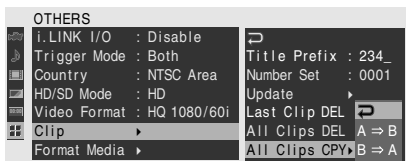

### 3 Specify the direction of copying.

A ⇔ B: To copy from the card in slot A to that in slot B

B ⇔ A: To copy from the card in slot B to that in slot A

A confirmation message is displayed.

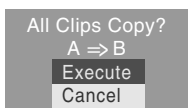

### 4 Select “Execute.”

Copying begins.

The status of progress is displayed during copying.

In HD Mode, only the clips of HD Mode are copied.

In SD Mode, only the clips of SD Mode are copied.

#### To cancel copying in progress

Press the CANCEL button.

Copying is canceled, and the OTHERS menu screen is restored.

#### When copying is completed

The completion message displayed. When the OTHERS menu screen is restored, press the MENU button to exit Menu mode.

### Deleting Clips

You can delete clips from the SxS memory card.

#### Note

An HD-mode clip marked OK cannot be deleted. To delete the clip, first remove the OK mark (*see page 103*).

### Deleting a specified clip

You can delete a clip selected on the thumbnail screen.

### 1 Select the clip you wish to delete on the thumbnail screen then press the joystick or the jog dial.

The Clip Operation menu of the thumbnail screen pops up.

### 2 Select “DELETE CLIP” from the Clip Operation menu.

The information screen for the selected clip appears, and a confirmation message is displayed below the index frame image.

### 3 To delete, select “Execute” then press the jog dial or the joystick.

The clip is deleted.

The subsequent clips are shifted by one on the thumbnail screen.

## Deleting clips collectively

By using the Setup menu, you can delete clips from an SxS memory card collectively.

### Notes

- If the memory card contains clips of both HD and SD Mode, only the clips of the currently selected mode are deleted.
- HD-mode clips marked OK are not deleted.

- 1 Press the MENU button when the normal thumbnail screen is displayed or in the Stop status.**
- 2 Select “All Clips DEL” from “Clip” of the OTHERS menu.**
- 3 Select “Execute.”**  
A confirmation message is displayed.
- 4 Select “Execute” again.**  
Deleting begins.

The status of progress is displayed during deleting.

In HD Mode, only the clips of HD Mode are deleted.

In SD Mode, only the clips of SD Mode are deleted.

### To cancel deleting in progress

Press the CANCEL button.

Deleting is canceled, and the OTHERS menu screen is restored.

### When deleting is completed

The completion message displayed. When the OTHERS menu screen is restored, press the MENU button to exit Menu mode.

## Displaying the EXPAND CLIP Screen

In HD Mode, the EXPAND CLIP screen permits you to divide a clip into 12 blocks of equal duration and show a thumbnail image of the first frame of each block on the screen.

In SD Mode, the EXPAND CLIP screen shows the thumbnail images of the first frames of the segment files only for a clip segmented because its file size exceeded 2GB.

This helps you to quickly cue up to a desired scene in a clip of long duration.

You can display the EXPAND CLIP screen by selecting the clip on the thumbnail screen or on the still picture of the clip in Pause mode.

- 1 Pause the playback or select a clip on the thumbnail screen then press the joystick or the jog dial.**  
The corresponding Clip Operation menu pops up.
- 2 Select “EXPAND CLIP” from the Clip Operation menu.**

The EXPAND CLIP screen appears for the clip in Pause mode or that you selected on the thumbnail screen.

## EXPAND CLIP screen in HD Mode

In HD Mode, thumbnail images of the first frames of 12 blocks equal in duration of a clip are displayed on the EXPAND CLIP screen.

On the EXPAND CLIP screen in HD mode displayed by using the Clip Operation menu in Pause mode, the clip is displayed with the finest possible partitions.

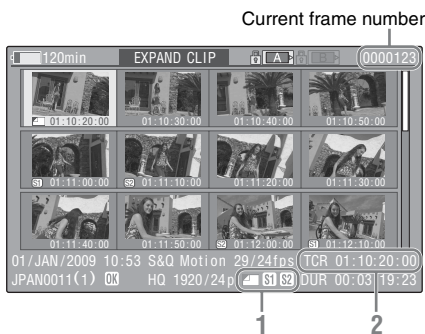

Detailed information for the clip is displayed at the bottom of the screen.

The items other than the following are the same as those on the normal thumbnail screen:

### 1. Frame information

The following icons show the marking for the frame at the cursor.

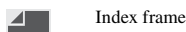

Index frame

<b>S1</b>	Frame with shot mark 1 added
<b>S2</b>	Frame with shot mark 2 added

The same icons may also be displayed below the thumbnail image of each frame. If the frame has multiple markings, one of the icons is displayed, in the priority order of index frame, shot mark 1, and shot mark 2.

## 2. Timecode indication

The timecode of the frame at the cursor is displayed.

## EXPAND CLIP screen in SD Mode

In SD Mode, the thumbnail images of the first frames of segment files are displayed for a clip segmented because its file size exceeded 2GB on the EXPAND CLIP screen.

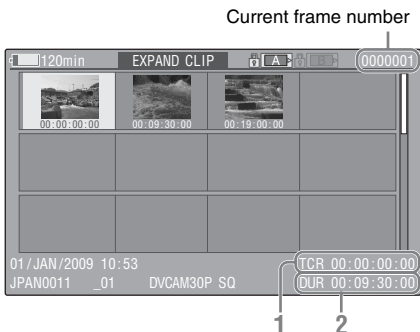

Detailed information for the clip is displayed at the bottom of the screen.

The items other than the following are the same as those on the normal thumbnail screen:

### 1. Timecode indication

The timecode of the segmentation file at the cursor is displayed.

### 2. Duration

The duration of the segmentation file at the cursor is displayed.

## Clip Operation menu on the EXPAND CLIP screen

### HD Mode

When you select a frame on the EXPAND CLIP screen and press the joystick or the jog dial, the

Clip Operation menu pops up to enable further operations.

Item	Function
EXPAND (COARSE)	To decrease the number of partitions of the clip
EXPAND (FINE)	To increase the number of partitions of the clip
PAUSE	To set to Pause mode at the selected frame
SET INDEX PIC	To specify the selected frame for the index frame of the clip ( <i>page 108</i> )
SHOT MARK1 ADD	To add shot mark 1 to the selected frame ( <i>page 107</i> )
SHOT MARK2 ADD	To add shot mark 2 to the selected frame ( <i>page 107</i> )
SHOT MARK1 DEL	To delete shot mark 1 from the selected frame ( <i>page 107</i> )
SHOT MARK2 DEL	To delete shot mark 2 from the selected frame ( <i>page 107</i> )
DIVIDE CLIP	To divide the clip into two clips at the selected frame ( <i>page 108</i> )

### SD Mode

You can select “PAUSE” only on the EXPAND CLIP screen in SD Mode.

## Displaying the SHOT MARK Screen (HD Mode Only)

When one or more shot marks are recorded for a single clip in HD Mode, the SHOT MARK screen permits you to display only the marked frames as the thumbnail images on the screen.

### 1 Select a clip on the thumbnail screen.

### 2 Press the joystick or the jog dial.

The Clip Operation menu pops up.

### 3 Select “SHOT MARK,” “SHOT MARK1,” or “SHOT MARK2.”

**SHOT MARK:** To display thumbnails only of the frames marked with shot mark 1 and/or shot mark 2 recorded

**SHOT MARK1:** To display thumbnails only of the frames marked with shot mark 1

**SHOT MARK2:** To display thumbnails only of the frames marked with shot mark 2

## SHOT MARK screen example



The detailed information of the clip is displayed at the bottom of the screen. The items other than the following are the same as those on the EXPAND CLIP screen:

### 1. Timecode indication

The timecode of the frame at the cursor on the SHOT MARK screen is displayed.

## Clip Operation menu on the SHOT MARK screen

When you select a frame on the SHOT MARK screen and press the joystick or the jog dial, the Clip Operation menu pops up to permit you further operations.

Item	Function
PAUSE	To set to Pause mode at the selected frame
SET INDEX PIC	To specify the selected frame for the index frame of the clip ( <i>page 108</i> )
SHOT MARK1 DEL	To delete the shot mark 1 from the selected frame ( <i>page 107</i> )
SHOT MARK2 DEL	To delete the shot mark 2 from the selected frame ( <i>page 107</i> )
DIVIDE CLIP	To divide the clip into two clips at the selected frame ( <i>page 108</i> )

## Adding/Deleting Shot Marks (HD Mode Only)

In HD Mode, you can add shot marks to the clips after recording or delete the recorded shot marks.

## Adding a shot mark in Pause mode

- 1 **Pause the playback at the frame to which you wish to add a shot mark then press the joystick or the jog dial.**

The Clip Operation menu pops up.

- 2 **Select “SHOT MARK1 ADD” or “SHOT MARK2 ADD” from the Clip Operation menu.**

The information screen for the selected frame appears, and a confirmation message is displayed below the image.

- 3 **Select “Execute.”**

## Adding a shot mark on the EXPAND CLIP screen

- 1 **Select the frame to which you wish to add a shot mark on the EXPAND CLIP screen then press the joystick or the jog dial.**

The Clip Operation menu pops up.

- 2 **Select “SHOT MARK1 ADD” or “SHOT MARK2 ADD” from the Clip Operation menu.**

The information screen for the selected frame appears, and a confirmation message is displayed below the image.

- 3 **Select “Execute.”**

## Deleting a shot mark

You can delete shot marks on the EXPAND CLIP screen (*page 105*) or on the SHOT MARK screen (*page 106*).

- 1 **Select a frame from which you wish to delete the shot mark on the EXPAND CLIP screen or the SHOT MARK screen then press the joystick or the jog dial.**

The Clip Operation menu pops up.

- 2 **Select the “SHOT MARK1 DEL” or “SHOT MARK2 DEL” from the Clip Operation menu.**

The information screen for the selected frame appears and a confirmation message is displayed below the image.

### 3 Select “Execute.”

## Changing the Index Frame (HD Mode Only)

In HD Mode, you can change the index frame of a clip to another frame you selected on the EXPAND CLIP screen (*page 105*) or the SHOT MARK screen (*page 106*).

**1 Select a frame to be the index frame on the EXPAND CLIP screen or the SHOT MARK screen then press the joystick or the jog dial.**

**2 Select “SET INDEX PIC” from the Clip Operation menu.**

The information screen of the selected frame appears and a confirmation message is displayed below the image.

### 3 Select “Execute.”

#### Note

Even if you specify a frame other than the top frame for the index frame, playback always begins from the top frame when you start it from the thumbnail screen.

## Dividing a Clip (HD Mode Only)

In HD Mode, you can divide a clip into two different clips at the frame you select on the EXPAND CLIP screen (*page 105*) or the SHOT MARK screen (*page 106*).

**1 Select the frame at which the clip is to be divided on the EXPAND CLIP screen or the SHOT MARK screen then press the joystick or the jog dial.**

The Clip Operation menu pops up.

**2 Select “DIVIDE CLIP” from the Clip Operation menu.**

The information screen for the selected frame appears, and a confirmation message is displayed below the image.

### 3 Select “Execute.”

The selected and subsequent frames are divided, creating two clips having different names.

The first 4 characters of the original clip name are carried on, continuing to the last number on the memory card by the second 4 numerics.

**Example:** If you divide a clip named ABCD0002 into two clips under the condition where a new clip will be named EFGH0100, clip ABCD0100 and clip ABCD0101 are created.

#### Note

If the remaining space on the memory card is insufficient for divided clips, a message informing you of it appears.

# Showing the Status Screens

This camcorder provides status screens of five kinds in Camera mode and four kinds in Media mode, permitting you to check the various settings and statuses of this unit.

The status screens can also be displayed on an external monitor.

For connections of an external monitor, see “Connecting External Monitors” on page 135.

## Available status screens

- CAMERA status screen (displayed only in Camera mode) (page 110)
- AUDIO status screen (page 111)
- VIDEO status screen (page 112)
- BUTTON/REMOTE status screen (page 112)
- BATTERY/MEDIA status screen (page 113)

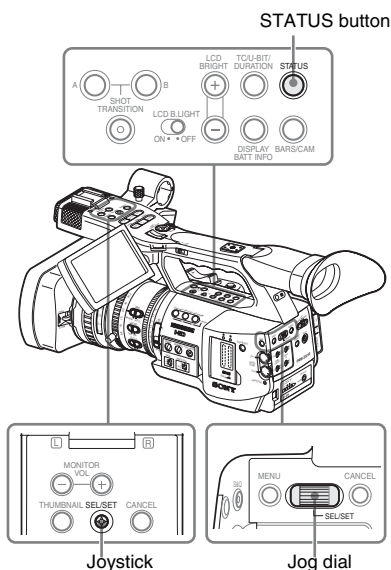

## Activating the status screen display

Press the **STATUS** button.

## Switching the status screens

Operating the joystick or the jog dial switches the screens in sequence.

## Canceling the status screen display

Press the **STATUS** button again. The status screen display is canceled.

# CAMERA Status Screen

The settings and statuses related to image shooting are displayed.  
The CAMERA status screen is obtained only in Camera mode. It is not displayed in Media mode.

CAMERA		1/5	
White Bal B:	12000K	Gain L:	0dB
A:	4700K	M:	9dB
PRST:	3200K	H:	18dB
Handle Zoom Speed H:	70	Zebra1:	On 70%
L:	30	2:	Off
Skin Tone Detail:	Off		
Picture Profile:	PP1 STANDARD		

## White Bal: White balance status

Display	Contents
B	The color temperature stored in white memory B is indicated. The color temperature of white memory B is detected/stored when you execute the auto white balance operation in Memory B mode.
A	The color temperature stored in white memory A is indicated. The color temperature of white memory A is detected/stored when you execute the auto white balance operation in Memory A mode.
PRST	The color temperature set as the preset white is indicated. The color temperature of preset white can be changed using the PICTURE PROFILE menu.

## Gain: GAIN switch settings

The gain values of the positions L, M, and H of the GAIN switch assigned with the CAMERA SET menu are displayed.

## Handle Zoom Speed: Handle zoom speed settings

The speed values assigned to the on-handle ZOOM button on the CAMERA SET menu are displayed.

Display	Contents
H	Speed obtained when the speed switch is set to the H position
L	Speed obtained when the speed switch is set to the L position

## Zebra: Zebra status

Display	Contents
1	This indication becomes "On" if you turn zebra on with the ZEBRA button when "1" or "Both" is selected for "Zebra Select" of the LCD/VF SET menu. The setting value of "Zebra1 Level" of the LCD/VF SET menu is displayed at the right. It shows "Off" when zebra is off or "2" is selected for "Zebra Select."
2	This indication becomes "On" if you turn zebra on with the ZEBRA button when "2" or "Both" is selected for "Zebra Select" of the LCD/VF SET menu. It shows "Off" when zebra is off or "1" is selected for "Zebra Select."

## Skin Tone Detail: Skin-tone detail status

The current status (On or Off) of "Setting" of "Skin Tone Detail" of the PICTURE PROFILE menu is displayed.

## Picture Profile: Picture Profile selection status

The selected Picture Profile number and name are displayed. (If Picture Profile is off, "Off" is displayed.)

# AUDIO Status Screen

Information regarding audio signals is displayed. The display configuration varies between Camera mode and Media mode.

## In Camera Mode

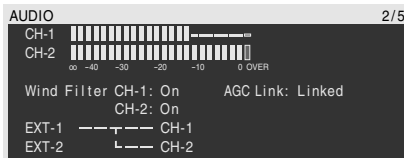

### CH-1/CH-2: Audio level meters

The levels of the CH-1 and CH-2 audio inputs (E-E audio levels) are displayed.

### Wind Filter: Wind filter settings

The current settings of “Wind Filter CH-1” and “Wind Filter CH-2” of the AUDIO SET menu are displayed.

### AGC Link: AGC link status

The “AGC Link” status (Linked or Separate) of the AUDIO SET menu is displayed.

### INT/EXT-CH-1/CH-2: Audio input settings

The inputs to CH-1 and CH-2 according to the “EXT CH Select” setting of the AUDIO SET menu and the AUDIO IN switch status are displayed.

AUDIO IN switch	EXT CH Select	Display
CH-1: INT	—	INT-L ——— CH-1
CH-2: INT	—	INT-R ——— CH-2
CH-1: EXT	—	EXT-1 ——— CH-1
CH-2: INT	—	INT-R ——— CH-2
CH-1: INT	—	INT-L ——— CH-1
CH-2: EXT	—	EXT-2 ——— CH-2
CH-1: EXT	CH-1/CH-2	EXT-1 ——— CH-1
CH-2: EXT	CH-1/CH-2	EXT-2 ——— CH-2
CH-1: EXT	CH-1	EXT-1 ——— CH-1
CH-2: EXT	CH-1	EXT-2 ——— CH-2

## In Media Mode



### CH-1/CH-2/CH-3/CH-4: Audio level meters

The playback audio levels of CH-1/CH-2 or CH-3/CH-4 are displayed according to the “Output CH” setting of the AUDIO SET menu.

If audio input is fed in via the i.LINK connector in STOP status or in external input recording, the input audio levels are indicated. In this case, the channel indications at the left of the meters are CH-1 and CH-2 regardless of the “Output CH” setting of the AUDIO SET menu.

In other conditions, the meters do not function.

### Output CH: Output channel setting

The “Output CH” setting of the AUDIO SET menu is displayed.

### Headphones: Headphone output

The output audio channel(s) for the headphones is(are) displayed. The “Monitor CH” setting of the AUDIO SET menu is valid as-is.

### Speaker: Speaker output

The output audio channel(s) for the built-in speaker is(are) displayed. As the speaker is monaural, the outputs are CH-1+CH2 or CH-3+CH4 even in stereo mode.

With nonstereo settings, the “Monitor CH” setting of the AUDIO SET menu is valid as-is.

## VIDEO Status Screen

The information on video formats and settings for the COMPONENT OUT, SDI OUT, HDMI OUT, A/V OUT and i.LINK connectors is displayed.

VIDEO		3/5
Video Format	: 1920/60i	
Rec Mode	: HQ	
Output Select	: 1920/60i	
A/V Out	: Off	
Down Converter	: Squeeze	
i.LINK I/O	: Disable	

### Video Format: Video format setting

The video format set in “Video Format” of the OTHERS menu is displayed.

In HD Mode, the horizontal resolution, frame rate, and scan format are displayed.

In SD Mode, the frame rate, scan format, and aspect (SQ/EC) are displayed.

### Rec Mode: Recording bit rate (HD Mode only)

The bit rate (HQ or SP) of the video format set in “Video Format” of the OTHERS menu is displayed.

### Output Select: Component and digital output status

The video format of the signal being fed from the COMPONENT OUT, SDI OUT, and HDMI OUT connectors according to the “Output Select” setting of the VIDEO SET menu is displayed.

### Video Out: Output status of the A/V OUT connector

The format (NTSC or PAL) of the analog composite signal being fed from the A/V OUT connector is displayed when “Output Select” of the VIDEO SET menu is set to “Composite.”

When the “Output Select” setting is other than “Composite,” “Off” is displayed.

### Down Converter: Down-converter setting of the SD output (HD Mode only)

The “Down Converter” setting (Squeeze, Edge Crop, Letterbox) of the VIDEO SET menu is displayed.

### i.LINK I/O: i.LINK I/O status

The i.LINK I/O setting (HDV/DVCAM/Disable) of the OTHERS menu is displayed.

## BUTTON/REMOTE Status Screen

The functions assigned to the assignable buttons and the status of the IR Remote Commander are displayed.

BUTTON/REMOTE		4/5
Assign Button 1:	Freeze Mix	
2:	Off	
3:	Off	
4:	Rec Review	
IR Remote	: On	

### Assign Button: Assignable button statuses

The functions assigned with the “Assign Button” of the OTHERS menu to the respective assignable buttons are displayed.

### IR Remote: IR Remote Commander status

The status (On: enabled, Off: disabled) of the IR Remote Commander is displayed

# BATTERY/MEDIA Status Screen

The information on the battery pack and SxS memory cards is displayed.

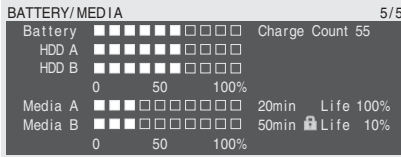

## Battery: Battery charge remaining

The remaining charge level of the mounted battery pack is displayed.

## Charge Count: Repeated charge times

The number of times that the mounted battery pack has been charged is displayed.

## HDD A/HDD B: Battery remaining of PHU-60K/120K/120R units

When PHU-60K/120K/120R Professional Hard Disk units are connected, the remaining power levels of the batteries of the PHU-60K/120K/120R units connected via the respective card slots are displayed.

## Media A/Media B: Remaining space, available recording time, and estimated service life (rewriting limit)

The remaining space of the SxS memory cards in the respective card slots is indicated on the meters.

At the right, the available time for recording if done at the current bit rate is displayed, in minutes.

The time indication will be “- - min” if no SxS memory card or an invalid card is in the slot.

If the card is write-protected, a  icon is shown to the right of the time indication.

The Life value is displayed only for an SxS memory card which supports the life value indication. It indicates the estimated remaining usable period of the card (virgin status as 100%).

If an alarm is generated, make a backup of the card as soon as possible and replace it with a new card.

# Overview of the Setup Menus

This camcorder permits you to make various settings for recording and playback with Setup menus on the LCD monitor/EVF screen.

The Setup menus can also be displayed on an external monitor.

For connections of an external monitor, see "Connecting External Monitors" on page 135.

## Setup Menu Configuration

The following menu icons are displayed when you press the MENU button, permitting you to select the corresponding menus.



### CAMERA SET menu

For setting the items related to recording other than those on picture quality (page 118).

The picture-quality items are set with the PICTURE PROFILE menu (page 87).



### AUDIO SET menu

For setting the audio-related items (page 123).



### VIDEO SET menu

For setting the items related to video outputs (page 124).



### LCD/VF SET menu

For setting the items related to the displays on the LCD monitor /EVF (page 125).



### TC/UB SET menu

For setting the items related to timecodes and user bits (page 128).



### OTHERS menu

For setting the other items (page 129).

## Setup Menu Layers

### MENU

CAMERA SET	<ul style="list-style-type: none"> <li>Gain Setup</li> <li>Shutter</li> <li>EX Slow Shutter</li> <li>Shot Transition</li> <li>MF Assist</li> <li>Color Bar Type</li> <li>Flicker Reduce</li> <li>Zoom Speed</li> <li>Zoom Trans</li> <li>Interval Rec</li> <li>Frame Rec</li> <li>P.Cache Rec</li> <li>S&amp;Q Motion</li> <li>Rec Review</li> <li>Fader</li> <li>TLCS</li> <li>Shockless White</li> <li>White Switch&lt;B&gt;</li> <li>ATW Speed</li> <li>Wide Conversion</li> <li>Steady Shot</li> <li>Image Inversion</li> </ul>
AUDIO SET	<ul style="list-style-type: none"> <li>Audio Input</li> <li>Audio Output</li> </ul>
VIDEO SET	<ul style="list-style-type: none"> <li>Output Select</li> <li>YPbPr/Digital Out Display</li> <li>Video Out Display</li> <li>Setup</li> <li>Down Converter</li> <li>24P System</li> </ul>
LCD/VF SET	<ul style="list-style-type: none"> <li>LCD</li> <li>EVF</li> <li>Peaking</li> <li>Marker</li> <li>Zebra</li> <li>Display On/Off</li> </ul>

(continues)

TC/UB SET	Timecode
	Users Bit
	TC Format
OTHERS	All Reset
	Camera Data
	Time Zone
	Clock Set
	Language
	Assign Button
	Tally
	Hours Meter
	IR Remote
	Battery Alarm
	Battery INFO
	Direct Menu
	i.LINK I/O
	Trigger Mode
	Country
	HD/SD Mode
	Video Format
	Clip
	Format Media
	Version
	Version Up

## Basic Menu Operations

This section covers basic operations for setting the Setup menu items.

### Menu controls

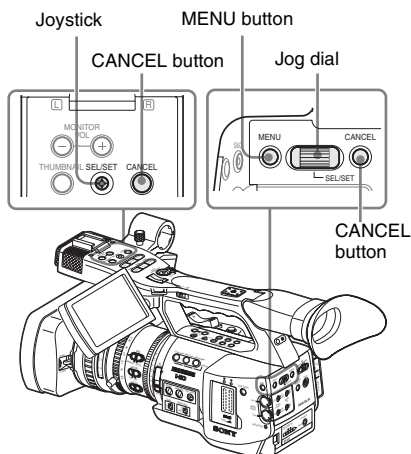

#### MENU button

To turn Menu mode to use Setup menus on/off.

#### Joystick (SEL/SET button)

When you tilt it, the cursor moves in the corresponding direction, permitting you to select menu items or setting values.

#### Jog dial (SEL/SET dial)

When you turn the dial, the cursor moves up or down, permitting you to select menu items or setting values.

#### CANCEL button

To return to the previous layer of the menu. An uncompleted change is canceled.

### Displaying the Setup menu

#### Press the MENU button.

The menu icons appear on the screen.

The cursor is displayed on the icon of the menu used last, and the corresponding menu item selection area is displayed to the right.

**Example: When the cursor is located at (CAMERA SET menu icon)**

Menu icon



Menu item selection area

**Note**

When the camcorder is in EXPAND FOCUS mode (page 57), the Setup menus cannot be operated. Press the EXPAND FOCUS button to release the mode.

**Setting the Setup menus**

**1 Rotate the jog dial or tilt the joystick back or forth to set the cursor to the icon of the menu you wish to set.**

The selectable menu items are displayed in the menu item selection area to the right of the icon.

**2 Press the jog dial or the joystick.**

The cursor moves to the menu item selection area.

You can also move the cursor to the menu item selection area by tilting the joystick to the right.

- The menu item selection area can show 7 lines at maximum. When all the selectable items cannot be displayed at one time, you can scroll the display up or down by moving the cursor.

A triangle appears at the upper or lower right corner of the menu item selection area to indicate that scrolling is enabled.

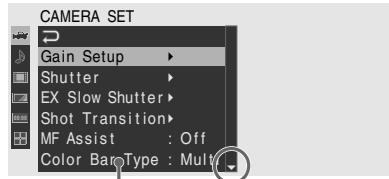

Displayed when there are more menu items beneath. (▲ shown at the top indicates that there are more menu items above.)

**Menu item selection area**

- A ► symbol is displayed to the right of any item that has subitems.
- The current setting value is displayed to the right of an item that has no subitems.
- To return to the previous layer, select ◀ or tilt the joystick to the left.

**3 Turn the jog dial or tilt the joystick back or forth to set the cursor to the menu item you wish to set then press the dial or the joystick to proceed.**

The setting area appears to the right of the menu item selection area, and the cursor moves to the top of its subitems.



**Setting area**

- The subitems and their current values are displayed.
- To return to the previous layer, select ◀, tilt the joystick to the left, or press the CANCEL button.

When you select an item that has no subitems and to be only On /Off or switched, the choices are displayed to the right of the item. In this case, proceed to step 5.

## Example

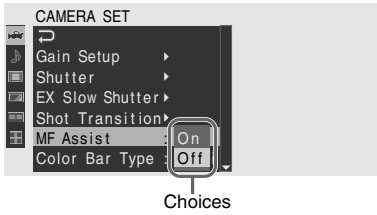

- 4 For the item that has subitems, turn the jog dial or tilt the joystick back or forth to set the cursor to the subitem you wish to set then press the dial or the joystick to proceed.**

The available values of the selected subitems are displayed, and the cursor moves to the current value.

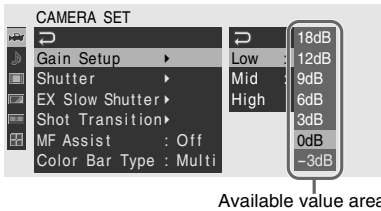

- The available value area can show 7 lines at maximum. When all the selectable values cannot be displayed at one time, you can scroll the display up or down by moving the cursor.

A triangle appears at the upper or lower right corner of the available value area to indicate that scrolling is enabled.

- For items having a wide range of available values (example: -99 to +99), the available value area is not displayed. The current setting is highlighted instead, indicating that the setting is ready for change.

- 5 Select the desired value by turning the jog dial or tilting the joystick back or forth then press the dial or the joystick to make the setting.**

The setting is changed, and the new setting is displayed.

When you select “Execute” for an execution item, the corresponding function is executed.

## For an item that requires your confirmation

When you select an item that you must confirm before execution in step 3, the menu display temporarily disappears, and a confirmation message is displayed. Following the instructions of message, specify whether to execute or cancel.

---

## Entering a character string

---

When you select an item for which a character string, such as a time value or filename, is to be specified, the input area for the character string is highlighted, and “SET” appears at the right end.

- 1 Select characters by turning the jog dial or tilting the joystick back and forth then press the dial or joystick to proceed.**

The cursor moves to the next column.

To return to the previous column, tilt the joystick to the left.

- 2 Perform setting in the same manner up to the last column/digit.**

The cursor moves to “SET.”

- 3 Press the jog dial or the joystick.**

The setting is completed.

---

## Terminating the menu operation

---

**Press the MENU button.**

The normal camera picture is resumed.

# Setup Menu List

The functions and available settings of menus are listed below.

The default settings set at the factory are shown in bold face (example: **Speed**).

The items marked with **[M]** in the Menu items column cannot be set in Media mode.

## CAMERA SET Menu

CAMERA SET		
Menu items	Subitems and setting values	Contents
<b>Gain Setup</b> Assigning gain levels to the three GAIN switch positions	Low -3 / <b>0</b> / 3 / 6 / 9 / 12 / 18 dB	Set the gain level to be used when the switch is set to the L position.
	Mid -3 / 0 / 3 / 6 / <b>9</b> / 12 / 18 dB	Set the gain level to be used when the switch is set to the M position.
	High -3 / 0 / 3 / 6 / 9 / 12 / <b>18</b> dB	Set the gain level to be used when the switch is set to the H position.
<b>Shutter</b> Specifying operating conditions of the electrical shutter (unselectable when “Setting” of “EX Slow Shutter” is “On”)	Mode <b>Speed</b> / Angle / ECS / SLS	Select modes of the Electronic Shutter.
	Shutter Speed <b>1/100</b>	Set the shutter speed when Speed mode is selected. <i>The available setting values vary depending on the video format being selected (see page 52).</i>
	Shutter Angle <b>180°</b> / 90° / 45° / 22.5° / 11.25°	Set the shutter angle when Angle mode is selected.
	ECS Frequency <b>60.02</b>	Set the ECS frequency when ECS mode is selected. <i>The available setting values vary depending on the frame rate of the video format selected.</i>
	SLS Frame <b>2</b> to 8 (Off)	Set the number of frames to accumulate when SLS mode is selected. (Off): For S&Q Motion or the SP 24P format (The setting cannot be changed.)
<b>EX Slow Shutter</b> Setting the Supersensitized Slow Shutter mode	Setting On / <b>Off</b>	Turn EX Slow Shutter mode on/off.
	Number of Frames <b>16</b> / 32 / 64	Set the number of frames to accumulate.

CAMERA SET		
Menu items	Subitems and setting values	Contents
<b>Shot Transition</b> Setting the operating conditions of Shot Transition	Trans Time 2 to 15 sec ( <b>4 sec</b> )	Set the time it takes to make a shot transition.
	Trans Speed 1 to 10 ( <b>5</b> )	Set the speed of the transition.
	Time / Speed Time / <b>Speed</b>	Determine whether to specify the transition by time or speed.
	Trans Curve Linear / Soft Trans / <b>Soft Stop</b>	Select the transition pattern. Linear: To make the transition linearly Soft Trans: To make the transition slowly at the beginning and end, but linearly in between Soft Stop: To make the transition slow down near the end
	Start Timer <b>Off</b> / 5 sec / 10 sec / 20 sec	Set the waiting time until the shot transition begins.
	Rec Link <b>Off</b> / Shot-A / Shot-B	Set the function to start a shot transition linked to recording start. Off: To start the transition using a button without linked to recording start Shot-A: To start a transition to Shot-A linked to recording start Shot-B: To start a transition to Shot-B linked to recording start
	<b>MF Assist</b> Turning the MF Assist Function on/off	On / <b>Off</b>
<b>Color Bar Type</b> Selecting the types of color bar	<b>Multi</b> / 75% / 100%	Select the type of color bars displayed when you press the BARS/CAM button. Multi: To output multiformat color bars 75%: To output 75% color bars 100%: To output 100% color bars
<b>Flicker Reduce</b> Setting Flicker Compensation	Mode Auto / On / <b>Off</b>	Set the operation of the Flicker-Reduction function. On: To always activate it Auto: To automatically activate it when flicker is detected. Off: To not activate it
	Frequency 50 Hz / 60 Hz <b>60 Hz</b> : UC model <b>50 Hz</b> : Other models	Set to the power supply frequency of the light source causing flicker.
<b>Zoom Speed</b> Setting the zoom speed	High 8 to 99 ( <b>70</b> )	Set the speed of zooming to be executed when you press the on-handle ZOOM button with the zoom speed switch set to H.
	Low 8 to 99 ( <b>30</b> )	Set the speed of zooming to be executed when you press the on-handle ZOOM button with the zoom speed switch set to L.
	Remote 8 to 99 ( <b>50</b> )	Set the speed of zooming to be executed when you press the ZOOM button of the IR Remote Commander.
		<b>Note</b> If the infrared line from the Remote Commander is not received properly, zooming may not operate smoothly.

## CAMERA SET

Menu items	Subitems and setting values	Contents
<b>Zoom Trans</b> Setting the zoom operation mode	<b>Linear</b> / Soft	Set the operation mode at the beginning and end of zooming with the on-handle ZOOM button.
<b>Interval Rec</b> Setting the Interval Recording function	Setting <b>On / Off</b>  Interval Time <b>1</b> to 10/15/20/30/40/50 sec 1 to 10/15/20/30/40/50 min 1 to 4/6/12/24 hour	Turn the Interval Recording function on/off.  Set the interval of recording in Interval Recording.
<b>Frame Rec</b> Setting the Frame Recording function	Setting <b>On / Off</b>  Number of Frames <b>1</b> / 3 / 6 / 9 or 2 / 6 / 12 (HQ 1280/60P, HQ 1280/50P)	Turn the Frame Recording function on/off.  Set the number of frames to be recorded at a time in Interval Recording.
<b>P.Cache Rec</b> Setting the Picture Cache Recording function	Setting <b>On / Off</b>  P.Cache Rec TTime <b>0-2sec</b> / 2-4sec / 4-6sec / 6-8sec / 8-10sec /13-15rec	Turn the Picture Cache Recording function on/off.  Set the time to cache video in the picture cache memory (the time to a point where recording is to start when you press the REC START/STOP button in Picture Cache Recording.
<b>S&amp;Q Motion</b> Setting the S&Q Motion function	On Format Country: NTSC Area HQ 1920/30P HQ 1920/24P HQ 1280/60P HQ 1280/30P <b>HQ 1280/24P</b> Country: PAL Area HQ 1920/25P HQ 1280/50P <b>HQ 1280/25P</b>	Set the recording video format in Slow & Quick Motion recording.
	Frame Rate On Format: HQ 1280/60P, HQ 1280/30P, HQ 1280/24P (NTSC) 1 to 60 ( <b>30</b> ) On Format: HQ 1920/30P, HQ 1920/24P (NTSC) 1 to 30 On Format: HQ 1280/50P, HQ 1280/25P (PAL) 1 to 60 ( <b>25</b> ) On Format: HQ 1920/25P (PAL) 1 to 30	Set the recording frame rate in Slow & Quick Motion recording.
<b>Rec Review</b> Setting the playback time for Rec-Review	<b>3 sec</b> / 10 sec / Clip	Set the time to play the last recorded clip using the Rec-Review function. 3 sec: Last 3 seconds 10 sec: Last 10 seconds Clip: Entire duration of the clip

**CAMERA SET**

Menu items	Subitems and setting values	Contents
<b>Fader</b> Setting the fade-in/ fade-out functions	Fade In On / <b>Off</b>	Turn the fade-in function on/off.
	Fade In Type White / <b>Black</b>	Select the fade-in mode. White: To fade in from a white screen Black: To face in from a black screen
	Fade In Time 1 sec / <b>2 sec</b> / 3 sec / 5 sec / 10 sec	Set the duration of the fade in.
	Fade Out On / <b>Off</b>	Turn the fade-out function on/off.
	Fade Out Type White / <b>Black</b>	Select the fade-out mode. White: To fade out to a white screen Black: To face out to a black screen
	Fade Out Time 1 sec / <b>2 sec</b> / 3 sec / 5 sec / 10 sec	Set the duration of the fade out.
	<b>TLCS</b> Setting the Total Level Control System (auto adjustment system of gain, iris and shutter)	Level +1.0 / +0.5 / <b>±0</b> / -0.5 / -1.0
Mode Backlight / <b>Standard</b> / Spotlight		Set the auto iris control mode in TLCS. Backlight: Backlight mode to reduce darkening of the center subject against lights Standard: Standard mode Spotlight: Spotlight mode to reduce blown-out highlights on the center subject in the spotlight
Speed -99 to +99 ( <b>+50</b> )		Set the tracing speed of TLCS control.
AGC On / <b>Off</b>		Turn the AGC (Auto Gain Control) function on/off.
AGC Limit 3 / 6 / 9 / <b>12</b> / 18 dB		Set the maximum gain in AGC.
AGC Point F5.6 / F4 / <b>F2.8</b>		Set the iris point for switching to auto-iris and auto-shutter control when AGC is on.
Auto Shutter On / <b>Off</b>		Turn the Auto Shutter control function on/off.
A.SHT Limit 1/100 1/150 1/200 <b>1/250</b>		Set the maximum shutter speed in Auto Shutter control.
A.SHT Point F5.6 / F8 / F11 / <b>F16</b>		Set the iris point for switching auto-iris and auto-shutter control when Auto Shutter is on.

**CAMERA SET**

<b>Menu items</b>	<b>Subitems and setting values</b>	<b>Contents</b>
<b>Shockless White</b> Setting the shockless white balance	Off / 1 / 2 / 3	Select the speed of change in white balance when the white balance mode is switched. Set to "Off" to instantly change the white balance. Select a larger number to change the white balance more slowly through interpolation.
<b>White Switch &lt;B&gt;</b> Setting for the WHITE BAL switch	<b>ATW</b> / MEM	Select the mode (ATW or Memory B) selected at the B position of the WHITE BAL switch.
<b>ATW Speed</b> Setting for Auto Tracing White Balance	1 / 2 / <b>3</b> / 4 / 5	Set the tracing speed of ATW. The larger the number you set, the speed becomes faster.
<b>Wide Conversion</b> Setting for use of a wide conversion lens	On / <b>Off</b>	Set to "On" when a wide conversion lens is attached.
<b>Steady Shot</b> Setting the image stabilizer	<b>On</b> / Off	Turn the Steady Shot (image stabilizer) function on/off.
<b>Image Inversion</b> Setting the image inversion function	<b>Normal</b> / H INV / V INV / H+V	Normal: Normal image direction H INV: To horizontally invert the image V INV: To vertically invert the image H+V: To horizontally and vertically invert the image Select "Execute" to invert. (The screen is black during the inversion process.)

## AUDIO SET Menu

### AUDIO SET

Menu items	Subitems and setting values	Contents
<b>Audio Input</b> Setting for audio inputs 	TRIM CH-1 -20 dBu to -65 dBu ( <b>-41 dBu</b> )	Finely adjust the sensitivity of channel 1 of external microphone input in steps of 3 dB in Manual audio adjustment mode.
	TRIM CH-2 -20 dBu to -65 dBu ( <b>-41 dBu</b> )	Finely adjust the sensitivity of channel 2 of external microphone input in steps of 3 dB in Manual audio adjustment mode.
	INT MIC Level -12 dB / -6 dB / <b>-0 dB</b> / +6 dB / +12 dB	Select the built-in microphone level in Manual audio adjustment mode.
	Limiter <b>On / Off</b>	Turn the audio limiter on/off.
	MIC AGC <b>High / Low</b>	Select the sensitivity of the microphone inputs.
	AGC Link <b>Linked / Separated</b>	Select the gain link condition when the audio level adjustment is in AGC mode. Linked: To vary the CH-1 gain and the CH-2 gain in synchronization. Separated: To vary the CH-1 gain and the CH-2 gain independently according to the respective levels.
	1KHz Tone <b>On / Off</b>	Turn the 1-kHz reference tone signal on/off.
	Wind Filter CH-1 <b>On / Off</b>	Turn the wind filter for channel 1 on/off.
	Wind Filter CH-2 <b>On / Off</b>	Turn the wind filter for channel 2 on/off.
	EXT CH Select CH-1 <b>CH-1/CH-2</b>	CH-1: To record channel 1 audio input on both channels 1 and 2. It is recommended to set the AUDIO SELECT (AUTO/MANUAL) switch and AUDIO LEVEL control for CH-2 (page 65) as well as the above TRIM CH-2 to the same conditions as those for CH-1. CH-1/CH-2: To record channel 1 and channel 2 inputs on the respective channels.
	<b>Audio Output</b> Setting for audio outputs	Monitor CH <b>CH-1/CH-2</b> (CH-3/CH-4) CH-1+CH-2 (CH-3+CH-4) CH-1 (CH-3) CH-2 (CH-4)
Output CH <b>CH-1/CH-2</b> CH-3/CH-4		Select audio output channels from either channels 1 and 2 or channels 3 and 4.
Alarm Level 0 to 7 ( <b>4</b> )		Set the alarm sound volume.
Beep <b>On / Off</b>		Select whether or not to sound a beep upon each operation.

# VIDEO SET Menu

## VIDEO SET

Menu items	Setting values	Contents
<b>Output Select</b> Setting the output signals	HD Mode <b>HD SDI Component</b> SD SDI Component HD HDMI SD HDMI Interlace SD HDMI Progressive Composite SD Mode <b>SD SDI Component</b> SD HDMI Interlace Composite	HD SDI Component: To output an HD analog component signal from the COMPONENT OUT connector and an HD SDI signal from the SDI OUT connector SD SDI Component: To output an SD analog component signal from the COMPONENT OUT connector and an SD SDI signal from the SDI OUT connector HD HDMI: To output an HD HDMI signal from the HDMI OUT connector SD HDMI Interlace: To output an SD HDMI interlace signal from the HDMI OUT connector SD HDMI Progressive: To output an SD HDMI Progressive signal from the HDMI OUT connector Composite: To output a composite signal from the A/V OUT connector
<b>YPbPr/Digital Out Display</b> Setting the character information for the component and digital outputs	On / Off	Set whether to add the same menus and status indications as those on the LCD monitor/EVF screen to the output signals from the COMPONENT OUT, SDI OUT and HDMI OUT connectors. (This setting cannot be changed if "Output Select" is "Composite.") <b>Note</b> On the thumbnail, EXPAND CLIP and SHOT MARK screens, the same menus and status indications as those on the LCD monitor/EVF screen are displayed regardless of the setting of this item.
<b>Video Out Display</b> Setting the character information for the composite output	On / Off	Set whether to add the same menus and status indications as those on the LCD monitor/EVF screen to the output signal from the A/V OUT connector. (This setting cannot be changed if "Output Select" is other than "Composite.") <b>Note</b> On the thumbnail, EXPAND CLIP and SHOT MARK screens, the same menus and status indications as those on the LCD monitor/EVF screen are displayed regardless of the setting of this item.
<b>Setup</b> Setting 7.5% setup for the composite signal	On / Off	Set whether to add 7.5% setup to the output signal from the A/V OUT connector when a format of NTSC is selected (Invalid when a format of PAL is selected). <b>Note</b> The default setting is different among the sales areas. United States and Canada: On Other areas: Off



VIDEO SET		
Menu items	Setting values	Contents
<b>Down Converter</b> Selecting the operation mode of the down converter	<b>Squeeze</b> / Letterbox / Edge Crop	Set the output mode (aspect) when outputting from the A/V OUT connector, or when outputting SD signals in HD Mode from the COMPONENT OUT and SDI OUT connectors. (The setting cannot be changed when an SD format is selected with "Output Select.") <b>Squeeze:</b> To horizontally reduce a 16:9 picture to output a 4:3 picture <b>Letterbox:</b> To mask the upper and lower areas of a 4:3 picture to display a 16:9 picture in the center of the screen <b>Edge Crop:</b> To cut the both sides of a 16:9 picture to output a 4:3 picture
<b>24P System</b> Selecting 24P mode	<b>60i</b> / 24PsF	Select the video output format when the video format is HQ 1920/24P or HQ 1440/24P (invalid with video formats other than HQ 1920/24P and HQ 1440/24P).

## LCD/VF SET Menu

LCD/VF SET		
Menu items	Subitems and setting values	Contents
<b>LCD</b> Adjusting the LCD monitor	<b>Color</b> -99 to +99 ( $\pm 0$ )	Adjust the color of pictures on the LCD monitor.
	<b>Contrast</b> -99 to +99 ( $\pm 0$ )	Adjust the contrast of pictures on the LCD monitor.
	<b>Brightness</b> -99 to +99 ( $\pm 0$ )	Adjust the brightness of pictures on the LCD monitor.
<b>EVF</b> Setting the viewfinder	<b>Backlight</b> <b>High</b> / Low	Select the brightness of the EVF backlight.
	<b>Mode</b> <b>Color</b> / B&W	Select the display mode of the EVF in Camera mode. Color: Color mode B&W: Monochrome mode
	<b>Contrast</b> -99 to +99 ( $\pm 0$ )	Adjust the contrast of pictures on the EVF screen.
	<b>Brightness</b> -99 to +99 ( $\pm 0$ )	Adjust the brightness of pictures on the EVF screen.
	<b>Power</b> <b>Auto</b> / On	Set the condition to turn the EVF on. Auto: To turn it on when the LCD monitor is closed or rotated to the upside-down position. On: To keep it on regardless of the status of the LCD monitor
<b>Peaking</b> Setting the peaking function for the LCD monitor/EVF	<b>Color</b> <b>White</b> / Red / Yellow / Blue	Select the color of the peaking signal.
	<b>Level</b> High / <b>Mid</b> / Low	Set the level of the peaking signal.



**LCD/VF SET**

<b>Menu items</b>	<b>Subitems and setting values</b>	<b>Contents</b>	
<b>Marker</b> Setting the markers added to pictures on the LCD monitor/EVF screen 	Setting <b>On / Off</b>	Turn all marker indications on/off in combination.	
	Safety Zone <b>On / Off</b>	Turn the safety marker on/off.	
	Safety Area 80% / <b>90%</b> / 92.5% / 95%	Select the size (ratio to the entire screen) of the safety zone marker.	
	Center Marker <b>On / Off</b>	Turn the center marker on/off.	
	Aspect Marker Line / Mask / <b>Off</b>	Select the aspect marker. Line: To show white lines Mask: To lower the video signal level of areas outside the marker range. Off: To not display	
	Aspect Select <b>4:3</b> / 13:9 / 14:9 / 15:9 / 1.66:1 / 1.85:1 / 2.35:1 / 2.4:1	Select the ratio of the aspect marker.	
	Aspect Mask 90% / 80% / 70% / 60% / 50% / 40% / 30% / 20% / 10% / <b>0%</b>	When "Aspect Marker" is "Mask," select the brightness of images outside the aspect marker.	
	Guide Frame <b>On / Off</b>	Turn the guide frame marker on/off.	
	<b>Zebra</b> Setting the zebra pattern 	Zebra Select <b>1</b> / 2 / Both	Select the zebra pattern(s) to be displayed. 1: To display zebra 1 only 2: To display zebra 2 only Both: To display both zebra 1 and zebra 2
		Zebra1 Level 50 to 107 ( <b>70</b> )	Set the display level of zebra 1.

## LCD/VF SET

Menu items	Subitems and setting values	Contents
<b>Display On/Off</b> Selecting the items to be displayed on the LCD monitor/EVF screen [M]	Video Level Warnings On / <b>Off</b>	Turn the warning indication to be displayed when the picture is too bright or too dark on/off.
	Brightness Display On / <b>Off</b>	Turn the numeric indication to show the picture brightness on/off.
	Histogram Display On / <b>Off</b>	Turn the histogram indication to show the level distribution of the picture on/off.
	Lens Info Meter / Feet / <b>Off</b>	Select the depth-of-field indication. Meter: To indicate in meters Feet: To indicate in feet Off: To not indicate
	Zoom Position <b>Number</b> / Bar / Off	Select the type of zoom position indication. Number: Indication with a number Bar: Indication with a bar Off: To not display
	Audio Level Meter <b>On</b> / Off	Turn the audio level meter indication on/off.
	Timecode <b>On</b> / Off	Turn the time data (timecode, user bits, duration) indication on/off.
	Battery Remain <b>On</b> / Off	Turn the battery remaining/DC input voltage indication on/off.
	Media Remain <b>On</b> / Off	Turn the media remaining indication on/off.
	TLCS Mode <b>On</b> / Off	Turn the TLCS mode indication on/off.
	Steady Shot <b>On</b> / Off	Turn the Steady Shot indication on/off.
	Focus Mode <b>On</b> / Off	Turn the focus operation mode indication on/off.
	White Balance Mode <b>On</b> / Off	Turn the white balance mode indication on/off.
	Picture Profile <b>On</b> / Off	Turn the Picture Profile indication on/off.
	Filter Position <b>On</b> / Off	Turn the ND filter setting indication on/off.
	Iris Position <b>On</b> / Off	Turn the iris setting indication on/off.
	Gain Setting <b>On</b> / Off	Turn the gain setting indication on/off.
	Shutter Setting <b>On</b> / Off	Turn the shutter mode and speed indication on/off.
	Fader Status <b>On</b> / Off	Turn the fader operation mode indication on/off.
	Rec Mode <b>On</b> / Off	Turn the special recording mode (Frame Rec, Interval Rec, S&Q Motion) indication on/off.
Video Format <b>On</b> / Off	Turn the video format indication on/off.	

## TC/UB SET Menu

### TC/UB SET

Menu items	Subitems and setting values	Contents
<b>Timecode</b> Setting the timecode	Mode <b>Preset</b> / Regen / Clock	Set the timecode mode. Preset: To start the timecode from the specified value Regen (regeneration): To continue the timecode from that of the previous clip Clock: To use the current clock time as the timecode
	Run <b>Rec Run</b> / Free Run	Set the running mode when the timecode mode is set to "Preset." Rec Run: The timecode advances only in recording mode. Free Run: The timecode keeps advancing regardless of recording.
	Setting	Set the timecode to a desired value. Select "SET" to finish the setting.
	Reset Execute / Cancel	Select "Execute" to reset the timecode to 00:00:00:00.
<b>Users Bit</b> Setting the user bits	Mode <b>Fix</b> / Date	Set the user bit mode. Fix: To use a desired fixed value as the user bits Date: To use the current date
	Setting	Set the user bits to a desired value.
<b>TC Format</b> Setting the time code format	<b>DF</b> / NDF	Set the timecode format. DF: Drop frame NDF: Non drop frame



## OTHERS Menu

### OTHERS

Menu items	Subitems and setting values	Contents
<b>All Reset</b> Resetting to the factory status	Execute/Cancel	Select "Execute" to reset the camcorder to the factory status.
<b>Camera Data</b> Storing/recalling the menu settings	Store Execute/Cancel	Select "Execute" to store the setting values in an SxS memory card.
	Recall Execute/Cancel	Select "Execute" to retrieve the setting values from an SxS memory card.
<b>Time Zone</b> Setting the time difference	UTC -12:00 to +14:00	Set the time-zone difference from UTC in steps of 30 minutes.  <b>Note</b> The default setting is different among the sales areas. United States and Canada: -5:00 Europe area: 0:00 Oceania: +10:00
<b>Clock Set</b> Setting the built-in clock	Date/Time	Set the current time and date.
	12H/24H 12H / <b>24H</b>	Select the display mode of time. 12H: 12-hour mode 24H: 24-hour mode
	Date Mode <b>YYMMDD</b> / MMDDYY / DDMMYY	Select the display mode of the date. YYMMDD: In sequence of year, month, day MMDDYY: In sequence of month, day, year DDMMYY: In sequence of day, month, year
<b>Language</b> Selecting the language for menus and messages	<b>English</b> / Chinese / Japanese	English: To display in English Chinese: To display in Chinese Japanese: To display in Japanese  <b>Note</b> "Japanese" is effective only on messages for warning and caution. The menus and status indications do not change.

## OTHERS

Menu items	Subitems and setting values	Contents
<b>Assign Button</b> Assigning functions to the assignable buttons	<1> Off / Marker / Last Clip DEL / ATW / ATW Hold / Rec Review / Rec / Picture Cache / Freeze Mix / Expanded Focus / Spotlight / Backlight / IR Remote / Shot Mark1 / Shot Mark2 / Fader / EVF Mode / BRT Disp / Histogram / <b>Lens</b> Info / OK Mark	Assign a function to the ASSIGN button of the corresponding number. The selectable functions are common. Marker: For turning the markers on/off Last Clip DEL: For deleting the last recorded clip ATW: For turning ATW on/off ATW Hold: For holding the ATW value Rec Review: For starting a Rec Review Rec: For starting/stopping recording Picture Cache: For turning picture caching on/off Freeze Mix: For executing Freeze Mix
	<2> Off / Marker / Last Clip DEL / ATW / ATW Hold / Rec Review / Rec / Picture Cache / Freeze Mix / Expanded Focus / Spotlight / Backlight / IR Remote / Shot Mark1 / Shot Mark2 / Fader / EVF Mode / <b>BRT Disp</b> / Histogram / Lens Info / OK Mark	Expanded Focus: For turning Expanded Focus on/off Spotlight: For selecting TLCS Spotlight mode Backlight: For selecting TLCS Backlight mode IR Remote: For activating/deactivating the IR Remote Commander Shot Mark1: For adding shot mark 1 (HD Mode only) Shot Mark2: For adding shot mark 2 (HD Mode only) Fader: For turning the Fader function on/off EVF Mode: For switching between color and monochrome modes of the EVF
	<3> Off / Marker / Last Clip DEL / ATW / ATW Hold / Rec Review / Rec / Picture Cache / Freeze Mix / Expanded Focus / Spotlight / Backlight / IR Remote / Shot Mark1 / Shot Mark2 / Fader / EVF Mode / BRT Disp / <b>Histogram</b> / Lens Info / OK Mark	BRT Disp: For turning the brightness level indication on/off Histogram: For turning the histogram indication on/off Lens Info: For turning the depth-of-field indication on/off OK Mark: For adding an OK mark (HD Mode only, not valid in Media mode) Off: No function
	<4> <b>Off</b> / Marker / Last Clip DEL / ATW / ATW Hold / Rec Review / Rec / Picture Cache / Freeze Mix / Expanded Focus / Spotlight / Backlight / IR Remote / Shot Mark1 / Shot Mark2 / Fader / EVF Mode / BRT Disp / Histogram / Lens Info / OK Mark	
<b>Tally</b> Setting the tally lamps	Front <b>High</b> / Low / Off	Set the brightness of the tally lamp on the front. High: To brighten the lamp Low: To dim the lamp Off: To not light the lamp
	Rear <b>On</b> / Off	Turn the tally lamp on the rear on/off.
<b>Hours Meter</b> Displaying the hours meter	Hours (Sys)	The non-resettable accumulated time of use is displayed.
	Hours (Reset)	The resettable accumulated time of use is displayed.
	Reset Execute/Cancel	Select "Execute" to reset the Hours (Reset) value to 0.

OTHERS		
Menu items	Subitems and setting values	Contents
<b>IR Remote</b> Activating/ deactivating the Remote Commander	On / <b>Off</b>	Set to "On" to activate remote control operations from the supplied IR Remote Commander.  <b>Note</b> The setting automatically returns to "Off" when the camcorder is turned off.
	<b>Battery Alarm</b> Setting the low power alarm	Low BATT 5% / <b>10%</b> / 15% / ... / 45% / 50% BATT Empty 3% to 7% ( <b>3%</b> ) DC Low Volt1 11.5 V to 17.0 V ( <b>11.5 V</b> ) DC Low Volt2 11.0 V to 14.0 V ( <b>11.0 V</b> )
<b>Battery INFO</b> Showing information regarding the battery pack (display only)	Type	The type (product name) is displayed.
	MFG Date	The date of manufacture is displayed.
	Charge Count	The accumulated number of times of charge/discharge is displayed.
	Capacity	The estimated total capacity of full charge is displayed.
	Voltage	The current output voltage is displayed.
	Remaining	The current remaining level is displayed.
<b>Direct Menu</b> Setting the Direct menu function 	All / <b>Part</b> / Off	All: All Direct menu operations are permitted. Part: A part of Direct menu operations is permitted. The operation is limited depending on the GAIN, SHUTTER, or WHITE BAL switch setting. Off: No Direct menu operation is permitted.
	<b>i.LINK I/O</b> Setting for input/ output at the i.LINK connector	HDV / DVCAM / <b>Disable</b>  <b>Notes</b> <ul style="list-style-type: none"> <li>When you set this item to "HDV" or "DVCAM," no signal is fed out from the SDI OUT connector.</li> <li>When you set this item to "HDV" or "DVCAM," Slow&amp;Quick Motion mode cannot be used.</li> <li>No HDV stream can be input/output when the video format is not HD SP mode.</li> </ul>
<b>Trigger Mode</b> Setting whether to trigger recording start/stop for an external device connected to via the i.LINK connector 	Internal / <b>Both</b> / External	Internal: To activate recording start/stop operations only for an SxS memory card in a built-in slot. Both: To activate recording start/stop operations both for an SxS memory card in a built-in slot and the external recording device connected via the i.LINK connector. External: To activate recording start/stop operations only for the external recording device connected via the i.LINK connector.

**OTHERS**

Menu items	Subitems and setting values	Contents
<b>Country</b> Setting the area for use	NTSC Area / PAL Area	Select the color system for the area where you will use the camcorder.  <b>Note</b> The default setting is different among the sales areas. United States and Canada: NTSC Area Other areas: PAL Area
<b>HD/SD Mode</b>	HD / SD	Switch between HD Mode and SD Mode for recording/playback. Select "Execute" to switch.
<b>Video Format</b> Selecting the video format	<b>HD Mode</b> Country: NTSC Area HQ 1920/60i HQ 1440/60i SP 1440/60i HQ 1920/30P HQ 1440/30P HQ 1920/24P HQ 1440/24P SP 1440/24P HQ 1280/60P HQ 1280/30P HQ 1280/24P Country: PAL Area HQ 1920/50i HQ 1440/50i SP 1440/50i HQ 1920/25P HQ 1440/25P HQ 1280/50P HQ 1280/25P <b>SD Mode</b> Country: NTSC Area DVCAM60i SQ DVCAM60i EC DVCAM30P SQ DVCAM30P EC Country: PAL Area DVCAM50i SQ DVCAM50i EC DVCAM25P SQ DVCAM25P EC	Select the video format for recording. <b>HD Mode</b> <ul style="list-style-type: none"> <li>• Bit rate HQ or SP</li> <li>• Horizontal resolution 1920, 1440, or 1280</li> <li>• Frame rate 24, 25, 30, 50, or 60</li> <li>• Scan system i (interlace) or P (progressive)</li> </ul> <b>SD Mode</b> <ul style="list-style-type: none"> <li>• Frame rate 25, 30, 50, or 60</li> <li>• Scan system i (interlace) or P (progressive)</li> <li>• Aspect SQ (Squeeze) or EC (Edge Crop)</li> </ul> <b>Note</b> The default setting is different among the sales areas. United States and Canada: HQ 1920/60i Other areas: HQ 1920/50i

**OTHERS**

Menu items	Subitems and setting values	Contents	
<b>Clip</b> Setting for clip name or deletion	Title Prefix	Call the Character Set screen to set the title part (4 to 46 characters) of the clip names.	
	<b>nnn_</b> (nnn=least three digits of the serial number) (Max. 7 characters displayed)	<b>Configuration of the Character Set screen</b> Character selection area (3 lines): To select a character to insert in the cursor position of the Title Prefix area. !#\$%()+,-.=@[ ]^_~0123456789 abcdefghijklmnopqrstuvwxyz ABCDEFGHIJKLMNOPQRSTUVWXYZ Cursor operation area (1 line): Space: To change the character in the cursor position to a space INS: To insert a space in the cursor position DEL: To delete a character in the cursor position ←: To move the cursor to the left →: To move the cursor to the right ESC: To cancel the change and exit the Character Set screen END: To validate the change and exit the Character Set screen	
		Title Prefix area (1 line): For entering the title <b>To set the title</b> <b>1</b> Using the joystick, select (highlight) a character in the character selection area to be entered in the cursor position of the Title Prefix area. Then press the joystick or jog dial. (The selected character is entered and the cursor moves to the right.) <b>2</b> Repeat step 1 for setting the title. (Use Space, INS, and DEL as required.) <b>3</b> When the title setting is completed, select END to exit the Character Set screen.	
		Number Set 0001 to 9999	Set the second 4-numeric part of the clip name.
		Update Media(A)/Media(B) Execute / Cancel	Select "Execute" to update the managerial file on the SxS memory card in the selected slot. <sup>1)</sup>
		Last Clip DEL Execute / Cancel	Select "Execute" to delete the last recorded clip.
		All Clips DEL Execute / Cancel	Select "Execute" to delete all clips on the active SxS memory card.
			<b>Note</b> Clips to which you applied OK mark cannot be deleted.
		All Clips CPY A⇒B B⇒A	To copy all clips on an SxS memory card to the other. Select "Execute" to begin.
	<b>Format Media</b> Formatting SxS memory cards	Media (A) Execute / Cancel	Select "Execute" to format the SxS memory card in slot A.
Media (B) Execute / Cancel		Select "Execute" to format the SxS memory card in slot B.	
<b>Version</b> Showing the version of this unit	Vx.xx	The current software version of the camcorder is displayed.	

**OTHERS**

<b>Menu items</b>	<b>Subitems and setting values</b>	<b>Contents</b>
<b>Version Up</b> Updating this unit	Execute / Cancel	Use when updating of the camcorder is required. Select "Execute" to begin.. <b>Note</b> This item cannot be selected when no SxS memory card has been loaded.

1)If recording/playback cannot be made with an SxS memory card because it has been operated with a device other than this camcorder, or for some other reason, updating the managerial file on the card may improve the situation.

# Connecting External Monitors

To display recording/playback pictures on an external monitor, select the output signal and use

an appropriate cable for the monitor to be connected.

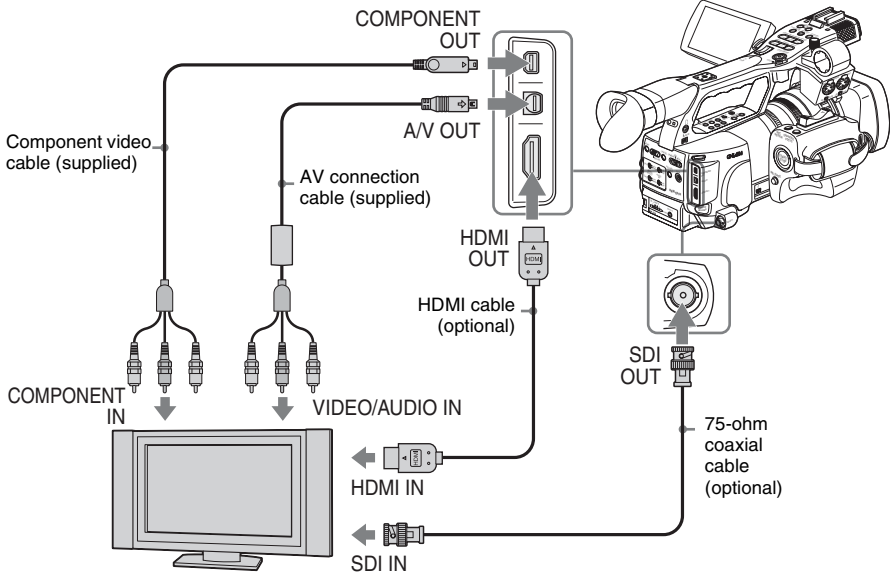

Regardless of whether the signal is HD or SD, the same status information and menus can be displayed on the external monitor as those on the LCD monitor/EVF screen.

According to the signal fed to the monitor, set “YPbPr/Digital Out Display” or “Video Out Display” of the VIDEO SET menu (page 124) to “On.”

When outputting SD signals in HD Mode, select in advance the output mode (Squeeze, Letterbox, or Edge Crop) with “Down Converter” of the VIDEO SET menu.

**Note**

SD signals down-converted for output have the following restrictions:  
 Images of 50P/50i/25P are output as PAL signals, those of 59.94P/59.94i/29.97P are output as NTSC signals, and those of 23.98P are output as 2-3 pulled-down NTSC signals.

## SDI OUT connector (BNC)

The connector is set at the factory to output an HD SDI signal.

When you set the camcorder to SD Mode, the connector outputs an SD SDI signal. Using “Output Select” (page 124) of the VIDEO SET menu, you can change the setting so that it outputs down-converted SD SDI signal for monitoring even in HD Mode. (The HD/SD switching becomes valid also on the COMPONENT OUT connector in synchronization.)

Use a commercially available 75-ohm coaxial cable for connection.

### To display the menus and status information on the connected monitor

Set “YPbPr/Digital Out Display” (page 124) of the VIDEO SET menu to “On.”

**Note**

If input/output at the i.LINK (HDV/DV) connector are enabled (*page 139*), no signal is fed out from the SDI OUT connector.

---

**COMPONENT OUT connector (mini-D connector)**

---

The connector is set at the factory to output HD analog component signals for monitoring.

When you set the camcorder to SD Mode, the connector outputs SD analog component signals. Using “Output Select” (*page 124*) of the VIDEO SET menu, you can change the setting so that it outputs down-converted SD analog component signals for monitoring even in HD Mode. (The HD/SD switching becomes valid also on the SDI OUT connector in synchronization.)

Use the supplied component video cable for connection.

**To display the menus and status information on the connected monitor**

Set “YPbPr/Digital Out Display” (*page 124*) of the VIDEO SET menu to “On.”

---

**HDMI OUT connector (Type A connector)**

---

Signal output from this connector is enabled by setting “Output Select” (*page 124*) of the VIDEO SET menu.

In HD Mode, you can select HD HDMI, SD HDMI interlace, or SD HDMI Progressive output.

In SD Mode, only an SD HDMI interlace signal can be output.

Use a commercially available HDMI cable for connection.

**To display the menus and status information on the connected monitor**

Set “YPbPr/Digital Out Display” (*page 124*) of the VIDEO SET menu to “On.”

---

**A/V OUT connector (audio/video composite multiconnector)**

---

When “Output Select” (*page 124*) of the VIDEO SET menu is set to “Composite,” the connector outputs 2-channel audio and down-converted SD analog composite signals for monitoring.

Use the supplied AV connection cable for connection.

**To display the menus and status information on the connected monitor**

Set “Video Out Display” (*page 124*) of the VIDEO SET menu to “On.”

# Operating Clips With a Computer

The clips recorded on SxS memory cards with this camcorder can be controlled on a computer or edited using the optional nonlinear editing software.

For these purposes, the clips on an SxS memory card can be operated by directly loading the card in a computer or by connecting the camcorder or the optional SBAC-US10 SxS Memory Card USB Reader/Writer to the computer, using an USB cable as shown below.

## Preparations

### To use the ExpressCard slot of a computer

If the computer is equipped with an ExpressCard/34 or ExpressCard/54 slot, you can directly insert the SxS memory card containing clips recorded with this camcorder and access to the files.

For the operating requirements for the computer, see "Using the Software" on page 16.

#### Note

The SxS Device Driver Software on the CD-ROM supplied with the camcorder must be installed on your computer. Before installation, be sure to read the enclosed SxS Device Driver Software End-User License Agreement.

For information on installation of the driver, refer to the *ReadMe* on the supplied CD-ROM.

For support information for the driver, visit the following URL:

<http://www.sony.net/SxS-Support/>

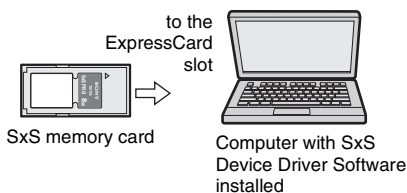

With a Windows computer, check that a Removable Disk appears in My Computer. This indicates normal status.

With a Macintosh computer, an icon is displayed on the menu bar.

### To connect with a USB cable

When you connect the camcorder or the SBAC-US10 SxS Memory Card USB Reader/Writer (optional) using the supplied USB cable, the memory card in the slot is acknowledged as an extended drive by the computer.

When two memory cards are mounted in this camcorder, they are acknowledged as two independent extended drives by the computer.

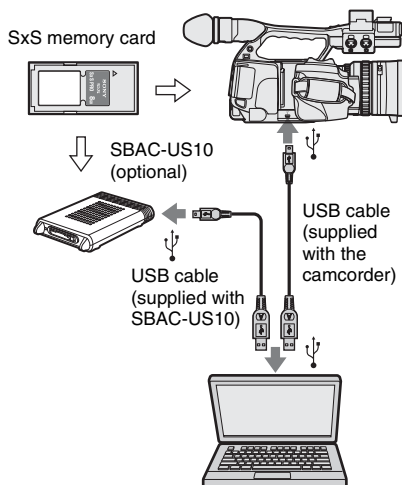

#### Notes

- When connecting the USB cable to the computer, be careful to check the form and direction of the USB connector.
- The camcorder and the SBAC-US10 do not work on the bus power from the computer. Supply the operating power independently.

### To check the connection to the camcorder

#### 1 Turn the camcorder on by setting the power switch to CAMERA or MEDIA.

A message prompting you to confirm that you wish to enable the USB connection is displayed on the LCD monitor/EVF screen.

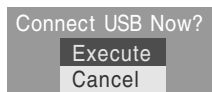

#### Note

This message will not be displayed while another confirmation message or in-progress

message (e.g., for formatting or restoration of an SxS memory card) is shown on the screen. It appears when formatting or restoration is completed.

The message is also not displayed while the CLIP INFO screen is shown on the screen. It appears when an operation on the CLIP INFO screen is completed or you return to the thumbnail screen.

## 2 Select “Execute” by operating the jog dial or the joystick.

The screen displays the following:



## 3 With Windows, check that the memory card is displayed as a removable disk in My Computer.

**With Macintosh, check that a “NO NAME” or “Untitled” folder was created on the desktop.**

This indicates that the connection is active. (The folder name on the desktop of the Macintosh computer can be changed as needed.)

### Note

The following operations must be eliminated when the access lamp is lit in red.

- Turning the power off or disconnecting the power cord
- Removing the SxS memory card
- Disconnecting the USB cable

When using the SBAC-US10, refer to the operating instructions of the SBAC-US10.

---

## Removing an SxS memory card

---

### Windows

1. Click on the icon of “Safely Remove Hardware” on the task bar of the computer.
2. Select “Safely remove SxS Memory Card - Drive(X:)” from the displayed menu.
3. Check that the Safe To Remove Hardware message appears then remove the card.

### Macintosh

Drag the SxS memory card icon on the desktop to Trash.

If the SxS memory card icon is located on Finder, click on the eject icon on its side.

### Note

Do not select “Card Power Off” from the SxS memory card icon displayed on the menu bar.

---

## Using the XDCAM EX Clip Browsing Software

---

To copy clips to the local disk of a computer, the XDCAM EX Clip Browsing Software must be used.

Install the XDCAM EX Clip Browsing Software on the supplied CD-ROM to your computer.

Although the data regarding recorded materials are stored over multiple files and folders, you can easily handle the clips without considering such data and directory structure by using the XDCAM EX Clip Browsing Software.

### Note

If you operate, e.g. copy the clips on the SxS memory card by using the Explorer (Windows) or Finder (Macintosh), the subsidiary data contained by the clips may not be maintained. To avoid such a problem, use the XDCAM EX Clip Browsing Software.

*For the operating requirements, installation and operations, visit the web sites shown in “XDCAM EX web sites” on page 15 or refer to the User’s Guide contained in the CD-ROM.*

*For support information on the XDCAM EX Clip Browsing Software, visit the web sites shown in “XDCAM EX web sites” on page 15 or on the cover page of the supplied CD-ROM.*

---

## Using a nonlinear editing system

---

For a nonlinear editing system, optional editing software that corresponds to the recording formats used with this camcorder is required.

Store the clips to be edited on the HDD of your computer in advance, using the supplied XDCAM EX Clip Browsing Software.

Some editing software may not operate properly. Be sure to confirm before use that it conforms to the recording formats used with this camcorder.

## To use Final Cut Pro of Apple Inc.

It is necessary to convert the clips to files that can be edited with the Final Cut Pro, using XDCAM Transfer.

*For information on XDCAM Transfer or Log & Transfer, visit the web sites shown in "XDCAM EX web sites" on page 15 or on the cover page of the supplied CD-ROM.*

---

## Notes on use of applications

---

When using any of the following application programs, be sure to use the latest version that supports this camcorder.

- XDCAM EX Clip Browsing Software
- XDCAM Transfer (PDZK-P1)
- Log & Transfer (PDZK-LT1)

If you use the XDCAM EX Clip Browsing Software V2.5.1 or earlier to view clips, clips recorded in SD Mode become invisible.

In such a case, proceed by either of the following methods:

- Execute "Update Media" of "Clip" of the OTHERS menu (*see page 133*).
- Use the latest version of the XDCAM EX Clip Browsing Software to view the clips in the respective card (or folder).

## Connecting an External Device (i.LINK Connection)

When an HDV-compatible video format (SP 1440/60i, SP 1440/50i, or SP 1440/24P) or a DVCAM-compatible video format (format of SD Mode) is selected, setting the "i.LINK I/O" of the OTHERS menu to "HDV" or "DVCAM" enables signal inputs/outputs via the i.LINK(HDV/DV) connector.

You can record the same images as those recorded on an SxS memory card in this camcorder on an external device connected to the i.LINK(HDV/DV) connector, or record playback pictures (HDV streams) of the external device on the memory card in the camcorder.

For playback, DVCAM streams of 16-bit 2-channel lock audio are acceptable.

Nonlinear editing conforming to the HDV format is also enabled.

### Notes

- DVCAM streams cannot be recorded with the camcorder.
- When you set "i.LINK I/O" of the OTHERS menu to "HDV" or "DVCAM," no signal is output from the SDI OUT connector. And Slow&Quick Motion mode cannot be used with "i.LINK I/O" set to "HDV" or "DVCAM."
- Use the i.LINK(HDV/DV) connector only for one-to-one i.LINK connection.
- When you change a setting which affects output signals from the i.LINK(HDV/DV) connector, such as "i.LINK I/O," "HD/SD Mode," "Video Format" of the OTHERS menu, "Output Select," or "Down Converter" of the VIDEO SET menu, disconnect the i.LINK cable then change the setting. Changing such a setting with the i.LINK cable connected may cause improper operation of the connected i.LINK device.

## Recording the Camcorder Picture on an External Device

When you set the camcorder to Camera mode, the picture being shot with this camcorder is output as

an HDV or DVCAM stream via the i.LINK(HDV/DV) connector. It can be recorded on a connected HDV or DVCAM recorder in synchronization with the REC START/STOP operation on this camcorder.

## 1 Perform the preparatory settings of the camcorder.

- Set “i.LINK I/O” (page 131) of the OTHERS menu to “HDV” or “DVCAM.”  
**HDV:** To output an HDV stream when you set the video format to SP 1440/60i, SP 1440/50i, or SP 1440/24P in HD Mode  
**DVCAM:** To output a DVCAM stream in SD Mode
- Set “Trigger Mode” (page 131) of the OTHERS menu to “Both” or “External.”  
**Both:** To record both on the memory card in the camcorder and on the external device  
**External:** To record only on the external device

## 2 Set the external device to recording standby status.





For operations of the external device, refer to the operation manual of that device.

## 3 Set the camcorder to Camera mode by setting the power switch to CAMERA.

## 4 Press the REC START/STOP button.

The external device starts recording in synchronization.

The status of the external device is displayed in the i.LINK status indication area (page 23) on the LCD monitor/EVF screen.

Indication	Status of the external device
STBY 	In HDV recording standby
●REC 	In HDV recording
STBY 	In DV recording standby
●REC 	In DV recording

### Notes

- Operation may be different depending on the type of external device.
- There is some time lag from when you press the REC START/STOP button of this camcorder until the i.LINK status indication changes. Recording does not start on the connected

i.LINK device before it enters synchronization even if “Trigger Mode” is set to “Both.”

- While you can record shot marks on the memory card during recording, they are not added to the pictures recorded on the external device.

## Nonlinear Editing

You can transfer an HDV stream to a nonlinear editing system connected via the i.LINK(HDV/DV) connector.

### Notes

- The i.LINK(HDV/DV) connector of this camcorder is a 4-pin connector. Check the number of pins of the i.LINK connector on your computer and use an appropriate i.LINK cable.
- In searching pictures of this camcorder on the computer, it may take some time until the display is reflected on the computer.
- If the playback clip is short or the playback starting point is near the end of the clip, the i.LINK signal may be interrupted between the clip and the next clip. When you try to capture such a signal using the nonlinear editing system, a malfunction may occur, depending on the nonlinear editing software in use.
- If you specify a search speed other than 4, 15, or 24 times normal with the nonlinear editing system, no i.LINK signal is fed out. In such a case, the picture on the LCD monitor may stay frozen.
- High-speed playback picture may not be displayed on the computer screen, depending on the nonlinear editing software in use.

### Setting on this camcorder

Set “i.LINK I/O” of the OTHERS menu to “HDV” or “DVCAM.”

For operations of the nonlinear editing software, refer to the operation manual of the software.

## Recording External Input Signals

The HDV stream input from a device connected via the i.LINK connector can be recorded on an SxS memory card in this camcorder. The timecodes superimposed on the i.LINK input are recorded regardless of the settings of the camcorder.

**Note**

DVCAM streams cannot be recorded.

restarted, incrementing the clip number on the memory card.

**1 Set the external signal to a format that can be recorded on the camcorder.**

Signals of 1440 × 1080/59.94i can be recorded when “Video Format” (*page 132*) is set to SP 1440/60i or SP 1440/24P. Signals of 1440 × 1080/50i can be recorded when set to SP 1440/50i.

Recording is not allowed with other combinations of “Video Format” and input signals.

**2 Set “i.LINK I/O” (*page 131*) of the OTHERS menu to “HDV.”**

**3 Set the camcorder to Media mode.**

**4 Press the STOP button to set the camcorder to STOP mode.**

The input image is displayed on the LCD monitor/EVF screen and the monitor connected via the COMPONENT OUT connector or A/V OUT connector.

The audio signal is output from the built-in speaker (or headphones connected to the headphone jack) and the speaker of the monitor connected to the A/V OUT connector.

**5 Press the REC START/STOP button on the handle.**

Recording begins.

**Notes**

- The REC START/STOP button on the grip does not function.
- An error is generated in the following cases. In such a case, cancel Recording mode by pressing the REC START/STOP button.
  - The video format of input signal does not match that specified on the camcorder.
  - A copy-protected stream is being fed in.
- If the input to the camcorder becomes no signal during recording, the tally lamps and the i.LINK ●REC status indication on the LCD monitor/EVF screen flash, indicating that no signal is being recorded on the SxS memory card.

When an input signal is resumed, recording is

## About i.LINK

This section explains the specifications and features of i.LINK.

### What is i.LINK?

i.LINK is a digital serial interface designed to integrate devices equipped with i.LINK connectors. i.LINK allows your device to:

- Perform two-way transmission and reception of data such as digital audio and digital video signals.
- Control other i.LINK devices.
- Easily connect multiple devices with a single i.LINK cable.

Your i.LINK device is capable of connecting to a wide range of digital AV devices for data transfer and other operations.

Other advantages include the following feature.

When connected to multiple i.LINK devices, your i.LINK device can perform data transfer and other operations not only

with the directly connected devices but also with any of the devices that are connected to those devices. Therefore, you do not need to be concerned with device connection order.

However, depending on the features and specifications of the connected devices, you may need to use certain functions differently, and you may not be able to transfer data or perform certain operations.

i.LINK, a nickname for IEEE 1394 proposed by Sony, is a trademark supported by many companies worldwide.

IEEE 1394 is an international standard defined by IEEE, the Institute of Electrical and Electronics Engineers, Inc.

#### Note

The camcorder can be connected to one device with the i.LINK cable (DV cable). When you connect with a device that has two or more i.LINK connectors, refer to the operating instructions supplied with the connected device.

### About data transfer speed of i.LINK

i.LINK defines a maximum data transfer speed of approximately 100, 200 and 400 Mbps<sup>1)</sup> that are described as S100, S200 and S400 respectively. For i.LINK devices, a maximum data transfer speed that the device supports is identified on “Specifications” page of the operating instructions supplied with the device or near its i.LINK connector.

<sup>1)</sup>When connecting with the device that support different data transfer speed, the actual data transfer speed may be different from those described on the i.LINK connectors.

### What is Mbps?

Mega bits per second. A measure of the rate at which data is transmitted per second. In case of 100 Mbps, 100 Mega bits of data can be transmitted per second.

### i.LINK operation with your camcorder

For details on operation when other equipment with i.LINK (HDV) connector is connected, *see page 139*.

For details on connection with i.LINK cable and necessary software, refer to the operating instructions supplied with the connected device.

### About the required i.LINK cable

Use the Sony 6-pin-to-4-pin or 4-pin-to-4-pin i.LINK cable (for HDV dubbing) to connect the i.LINK devices.

i.LINK and  are trademarks.

## Important Notes on Operation

### Use and Storage

#### Do not subject the unit to severe shock

- The internal mechanism may be damaged or the body warped.
- If an accessory mounted on the accessory shoe is subjected to severe shock, the accessory shoe may be damaged. In such a case, stop using it and contact your dealer or a Sony service representative.

#### Do not cover the unit while operating

Putting a cloth, for example, over the unit can cause excessive internal heat build-up.

#### After use

Always set the power switch to OFF.

#### Before storing the unit for a long period

Remove the battery pack.

#### Grip the handle when carrying

Grip the handle to carry. If you carry it by other parts, such as the front microphone block or the LCD monitor block, the camcorder may drop, causing injury.

#### Do not leave the camcorder with the lenses facing the sun

Direct sunlight can enter through the lenses, be focused in the camcorder, and cause fire.

### Shipping

- Remove the memory cards before transporting the unit.
- If sending the unit by truck, ship, air or other transportation service, pack it in the shipping carton of the unit.

### Care of the unit

Remove dust and dirt from the surfaces of the lens using a blower.

If the body of the unit is dirty, clean it with a soft, dry cloth. In extreme cases, use a cloth steeped in a little neutral detergent, then wipe dry. Do not use organic solvents such as alcohol or thinner, as these may cause discoloration or other damage to the finish of the unit.

To remove dust from inside the viewfinder remove the viewfinder by sliding it while holding the viewfinder release lever downward.

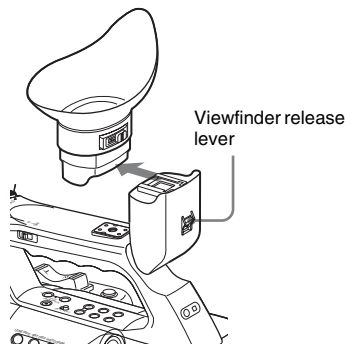

#### In the event of operating problems

If you should experience problems with the unit, contact your Sony dealer.

### Note about the battery terminal

The battery terminal of this unit (the connector for battery packs and AC adaptors) is a consumable part.

Power may not be supplied to the unit properly if the pins of the battery terminal are bent or deformed by shock or vibrations, or if they become corroded due to prolonged outdoor use. Periodic inspections are recommended to keep the unit working properly and to prolong its usable lifetime.

Contact a Sony service or sales representative for more information about inspections.

### Use and storage locations

Store in a level, ventilated place. Avoid using or storing the unit in the following places:

- In excessive heat or cold (operating temperature range: 0°C to 40°C or 32°F to 104°F)  
Remember that in summer in warm climates the temperature inside a car with the windows closed can easily exceed 50°C (122°F).
- In damp or dusty locations
- Locations where the unit may be exposed to rain
- Locations subject to violent vibration

- Near strong magnetic fields
- Close to radio or TV transmitters producing strong electromagnetic fields.
- In direct sunlight or close to heaters for extended periods

### To prevent electromagnetic interference from portable communications devices

The use of portable telephones and other communications devices near this unit can result in malfunctions and interference with audio and video signals.

It is recommended that the portable communications devices near this unit be powered off.

### Note on laser beams

Laser beams may damage the CMOS image sensors. If you shoot a scene that includes a laser beam, be careful not to let the laser beam be directed into the lens of the camcorder.

---

## About the LCD panels

---

The LCD panels are manufactured with extremely high-precision technology that yields effective pixel rates of 99.99% or higher.

However, very rarely, one or more pixels may be permanently dark or permanently lit in white, red, blue, or green.

This phenomenon is not a malfunction. Such pixels have no effect on the recorded data, and the unit may be used with confidence even if they are present.

---

## Phenomena specific to CMOS image sensors

---

The following phenomena that may appear in images are specific to CMOS (Complementary Metal Oxide Semiconductor) image sensors. They do not indicate malfunctions.

### White flecks

Although the CMOS image sensors are produced with high-precision technologies, fine white flecks may be generated on the screen in rare cases, caused by cosmic rays, etc.

This is related to the principle of CMOS image sensors and is not a malfunction.

The white flecks especially tend to be seen in the following cases:

- when operating at a high environmental temperature

- when you have raised the master gain (sensitivity)
- when operating in Slow-Shutter mode

### Aliasing

When fine patterns, stripes, or lines are shot, they may appear jagged or flicker.

### Flicker

If recording is made under lighting produced by discharge tubes, such as fluorescent, sodium, or mercury-vapor lamps, the screen may flicker, colors may vary, or horizontal stripes may appear distorted.

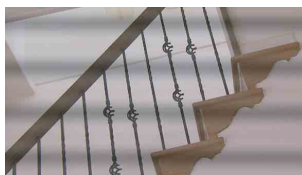

In such cases, set the Flicker-Reduction function to Auto mode (*see page 60*).

In some cases, such phenomena may not be improved with the Flicker-Reduction function.

It is recommend to set the electronic shutter speed to  $1/100$  sec. in 50-Hz areas and to  $1/60$  in 60-Hz areas.

### Focal plane

Owing to the characteristics of the pickup elements (CMOS sensors) for reading video signals, subjects that quickly move across the screen may appear slightly skewed.

### Flash band

The luminance at the top and bottom of the screen may change when shooting a flashlight beam or a light source that quickly flashes.

---

## Note on the viewfinder display

---

- Pictures on the LCD monitor and EVF screen may be distorted by the following operations:
  - Changing the video format
  - Rec Review
  - Starting playback from the Thumbnail screen
  - Reversing the LCD panel
  - Switching the Expanded Focus display
- When you change the eye direction in the EVF, you may see primary colors red, green, and blue, but this is not a defect of the camcorder.

These primary colors are not recorded on any recording media.

---

### Notes on data compatibility with other XDCAM EX-series products

---

- When you use a PMW-EX1/EX3/EX30 to play materials recorded on the PMW-EX1R, any media in which clips of formats not supported by the PMW-EX1/EX3/EX30 have been recorded cannot be used.
- The setting data (*page 93*) including picture profiles of the PMW-EX1R cannot be used on the PMW-EX1/EX3/EX30, PMW-10MD, or PMW-350 and vice versa.
- The setting data for the PMW-EX30, PMW-10MD, or PMW-350 cannot be used on the PMW-EX1R.
- The setting data for the PMW-EX1/EX3 can be used on the PMW-EX1R, but the settings for the following items are not reflected:
  - Color Correction (*page 87*)
  - Knee (*page 90*)The same picture quality as that with the PMW-EX1/EX3 is not reproduced.

---

### Fragmentation

---

If pictures cannot be recorded/reproduced properly, try formatting the recording medium. While repeating picture recording/playback with a certain recording medium for an extended period, files in the medium may be fragmented, disabling proper recording/storage. In such a case, make a backup of clips in the medium then perform formatting of the medium using “Format Media” (*page 133*) of the OTHERS menu.

## Formats and Limitations of Outputs

### Video Formats and Output Formats

The format of output signals from the COMPONENT OUT, SDI OUT, and HDMI OUT connectors varies according to the HD/SD Mode setting, recording/playback video formats and the kind of the output signal (the setting of “Output Select” of the VIDEO SET menu).

#### Notes

- While the COMPONENT OUT connector and SDI OUT connectors can be enabled at the same time, the HDMI OUT connector and the A/V OUT connector cannot be simultaneously enabled with another output connector.
- When “i.LINK I/O” of the OTHERS menu is set to “HDV” or “DVCAM,” no signal is output from the SDI OUT connector.

## Output formats in E-E (recording standby) status/recording (Camera mode)

Analog component signals from the COMPONENT OUT connector are output in the format shown below according to the “Video Format” setting of the OTHERS menu and the “Output Select” setting of the VIDEO SET menu.

The SDI OUT connector outputs serial digital signals of the same format as that of the analog component signals fed from the COMPONENT OUT connector.

“Video Format” setting	Output format		
	“Output Select” setting: HD SDI/Component HD HDMI	“Output Select” setting: SD SDI/Component SD HDMI Interlace Composite	“Output Select” setting: SD HDMI Progressive
HQ 1920/60i	1920×1080/59.94i	720×480/59.94i	720×480/59.94P
HQ 1440/60i			
SP 1440/60i			
HQ 1920/30P	1920×1080/29.97PsF	720×480/29.97PsF	
HQ 1440/30P			
HQ 1920/24P (24P System: 60i)	1920×1080/59.94i <sup>1)</sup>	720×480/59.94i <sup>1)</sup>	
HQ 1920/24P (24P System: 24PsF)	1920×1080/23.98PsF <sup>2)</sup>		
HQ 1440/24P (24P System: 60i)	1920×1080/59.94i <sup>1)</sup>		
HQ 1440/24P (24P System: 24PsF)	1920×1080/23.98PsF <sup>2)</sup>		
SP 1440/24P	1920×1080/59.94i <sup>1)</sup>		
HQ 1280/60P	1280×720/59.94P	720×480/59.94i <sup>3)</sup>	
HQ 1280/30P	1280×720/59.94P <sup>4)</sup>	720×480/29.97PsF <sup>5)</sup>	
HQ 1280/24P	1280×720/59.94P <sup>9)</sup>	720×480/59.94i <sup>1)</sup>	
DVCAM/60i SQ	Unselectable	720×480/59.94i SQ	
DVCAM/60i EC		720×480/59.94i EC	
DVCAM/30P SQ		720×480/29.97PsF SQ	
DVCAM/30P EC		720×480/29.97PsF EC	
HQ 1920/50i	1920×1080/50i	720×576/50i	720×576/50P
HQ 1440/50i			
SP 1440/50i			
HQ 1920/25P	1920×1080/25PsF	720×576/25PsF	
HQ 1440/25P			
HQ 1280/50P	1280×720/50P	720×576/50i <sup>6)</sup>	
HQ 1280/25P	1280×720/50P <sup>7)</sup>	720×576/25PsF <sup>8)</sup>	
DVCAM/50i SQ	Unselectable	720×576/50i SQ	
DVCAM/50i EC		720×576/50i EC	
DVCAM/25P SQ		720×576/25PsF SQ	
DVCAM/25P EC		720×576/25PsF EC	

1) 59.94i provided through 2-3 pulldown of 23.98P

2) If “Output Select” is “HD HDMI,” this setting is ignored and a 2-3 pulldown 1920/60i signal is output.

3) 59.94i provided through conversion from 59.94P

4) 59.94P provided by outputting each frame of 29.97P two times

5) 29.97PsF provided through conversion from 29.97P

6) 50i provided through conversion from 50P

7) 50P provided by outputting each frame of 25P two times

8) 25PsF provided through conversion from 25P

9) 59.94P provided by repeating each frame of 23.98P two or three times

## Output formats when a thumbnail screen is displayed (Media mode)

Analog component signals from the COMPONENT OUT connector are output in the format shown below according to the “Video Format” setting of the OTHERS menu and the “Output Select” setting of the VIDEO SET menu.

The SDI OUT connector outputs serial digital signals of the same format as that of the analog component signals fed from the COMPONENT OUT connector.

“Video Format” setting	Output format		
	“Output Select” setting: HD SDI/Component HD HDMI	“Output Select” setting: SD SDI/Component SD HDMI Interlace Composite	“Output Select” setting: SD HDMI Progressive
HQ 1920/60i	1920×1080/59.94i	720×480/59.94i	720×480/59.94P
HQ 1440/60i			
SP 1440/60i			
HQ 1920/30P			
HQ 1440/30P			
HQ 1920/24P			
HQ 1440/24P			
SP 1440/24P			
HQ 1280/60P			
HQ 1280/30P			
HQ 1280/24P			
DVCAM/60i SQ	Unselectable		Unselectable
DVCAM/60i EC			
DVCAM/30P SQ			
DVCAM/30P EC			
HQ 1920/50i	1920×1080/50i	720×576/50i	720×576/50P
HQ 1440/50i			
SP 1440/50i			
HQ 1920/25P			
HQ 1440/25P			
HQ 1280/50P			
HQ 1280/25P			
DVCAM/50i SQ			
DVCAM/50i EC			
DVCAM/25P SQ			
DVCAM/25P EC			
DVCAM/50i SQ	Unselectable		Unselectable
DVCAM/50i EC			
DVCAM/25P SQ			
DVCAM/25P EC			

## Output formats in clip playback mode (Media mode)

Analog component signals from the COMPONENT OUT connector are output in the format shown below according to the video format of the playback clip and the “Output Select” setting (HD or SD) of the VIDEO SET menu.

The SDI OUT connector outputs serial digital signals of the same format as that of the analog component signals fed from the COMPONENT OUT connector.

### When the frame rate setting of the video format is 60i/60P/30P/24P

Video format of playback clip	Output format			
	“Output Select” setting: HD SDI/Component HD HDMI	“Output Select” setting: SD SDI/Component SD HDMI Interlace Composite	“Output Select” setting: SD HDMI Progressive	
HQ 1920/60i	1920×1080/59.94i	720×480/59.94i	720×480/59.94P	
HQ 1440/60i				
SP 1440/60i				
HQ 1920/30P	1920×1080/29.97PsF	720×480/29.97PsF		
HQ 1440/30P				
HQ 1920/24P (24P System: 60i)	1920×1080/59.94i <sup>1)</sup>	720×480/59.94i <sup>1)</sup>		
HQ 1920/24P (24P System: 24PsF)				
HQ 1440/24P (24P System: 60i)				
HQ 1440/24P (24P System: 24PsF)				
SP 1440/24P				
HQ 1280/60P			1280×720/59.94P	720×480/59.94i <sup>3)</sup>
HQ 1280/30P			1280×720/59.94P <sup>4)</sup>	720×480/29.97PsF <sup>5)</sup>
HQ 1280/24P			1280×720/59.94P <sup>6)</sup>	720×480/59.94i <sup>1)</sup>
DVCAM/60i SQ	Unselectable	720×480/59.94i SQ	Unselectable	
DVCAM/60i EC		720×480/59.94i EC		
DVCAM/30P SQ		720×480/30PsF SQ		
DVCAM/30P EC		720×480/30PsF EC		
HQ 1920/50i	1920×1080/59.94i <sup>7)</sup>	720×480/59.94i <sup>7)</sup>	None	
HQ 1440/50i				
SP 1440/50i				
HQ 1920/25P	1920×1080/29.97PsF <sup>7)</sup>	720×480/29.97PsF <sup>7)</sup>		
HQ 1440/25P				
HQ 1280/50P	1280×720/60P <sup>7)</sup>	720×480/59.94i <sup>7)</sup>		
HQ 1280/25P		720×480/29.97PsF <sup>7)</sup>		
DVCAM/50i SQ	Unselectable	None		Unselectable
DVCAM/50i EC				
DVCAM/25P SQ				
DVCAM/25P EC				

1) 59.94i provided through 2-3 pulldown of 23.98P

2) If “Output Select” is set to “HD HDMI,” this setting is ignored and a 2-3 pulldown 1920/60i signal is output.

3) 59.94i provided through conversion from 59.94P

4) 59.94P provided by outputting each frame of 29.97P two times

5) 29.97PsF provided through conversion from 29.97P

6) 59.94P provided by repeating each frame of 23.98P two or three times.

7) Simplified playback, component signals only. The actual frame rate of the output signal is 1.001 times of the value shown in the table. Some frame may be

repeated when converting the frame rate. SDI and HDMI are not output.

### When the frame rate setting of the video format is 50i/50P/25P

Video format of playback clip	Output format			
	“Output Select” setting: HD SDI/Component HD HDMI	“Output Select” setting: SD SDI/Component SD HDMI Interlace Composite	“Output Select” setting: SD HDMI Progressive	
HQ 1920/60i	1920×1080/50i <sup>1)</sup>	720×576/50i <sup>1)</sup>	None	
HQ 1440/60i				
SP 1440/60i				
HQ 1920/30P	1920×1080/25PsF <sup>1)</sup>	720×576/25PsF <sup>1)</sup>		
HQ 1440/30P				
HQ 1920/24P	1920×1080/50i <sup>2)</sup>	720×576/50i <sup>1)</sup>		
HQ 1440/24P				
SP 1440/24P				
HQ 1280/60P				
HQ 1280/30P	1280×720/50P <sup>1)</sup>			
HQ 1280/24P	1280×720/50P <sup>3)</sup>	720×576/50i <sup>2)</sup>		
DVCAM/60i SQ	Unselectable	None	Unselectable	
DVCAM/60i EC				
DVCAM/30P SQ				
DVCAM/30P EC				
HQ 1920/50i	1920×1080/50i	720×576/50i	720×576/50P	
HQ 1440/50i				
SP 1440/50i				
HQ 1920/25P	1920×1080/25PsF	720×576/25PsF		
HQ 1440/25P				
HQ 1280/50P	1280×720/50P	720×576/50i <sup>4)</sup>		
HQ 1280/25P	1280×720/50P <sup>5)</sup>	720×576/25PsF <sup>6)</sup>		
DVCAM/50i SQ	Unselectable	720×576/50i SQ		Unselectable
DVCAM/50i EC		720×576/50i EC		
DVCAM/25P SQ		720×576/25PsF SQ		
DVCAM/25P EC		720×576/25PsF EC		

1) Simplified playback, component signals only. The actual frame rate of the output signal is 1/1.001 of the value shown in the table. Some frame may be deleted when converting the frame rate.

2) Simplified playback after 2-3 pulldown. Some frame may be deleted when converting the frame rate.

3) Simplified playback after repeating each frame of 23.98P two or three times. Some frame may be deleted when converting the frame rate.

4) 50i provided through conversion from 50P

5) 50P provided by outputting each frame of 25P two times

6) 25PsF provided through conversion from 25P

## Limitations of Outputs

The outputs from the camcorder are limited by the menu settings as follows:

### In Camera mode and during playback in Media mode

blank: no signal

Menu setting			Output								
HD/SD Mode	Video Format	i.LINK I/O	Output Select	SDI OUT	HDMI OUT	COMPONENT OUT	A/V OUT	i.LINK			
HD	HQ	Disable	HD SDI/Component	HD		HD					
			SD SDI/Component	SD		SD					
			HD HDMI		HD						
			SD HDMI Progressive		SD P						
			SD HDMI Interlace		SD i						
			Composite				SD				
	SP			HD SDI/Component	HD		HD				
				SD SDI/Component	SD		SD				
				HD HDMI		HD					
				SD HDMI Progressive		SD P					
				SD HDMI Interlace		SD i					
				Composite				SD			
				SD	SD	SD SDI/Component	SD		SD		
						SD HDMI Progressive					
SD HDMI Interlace		SD i									
Composite						SD					

Menu setting				Output						
HD/SD Mode	Video Format	i.LINK I/O	Output Select	SDI OUT	HDMI OUT	COMPONENT OUT	A/V OUT	i.LINK		
HD	HQ	HDV	HD SDI/Component			HD				
			SD SDI/Component							
			HD HDMI		HD					
			SD HDMI Progressive		SD P					
			SD HDMI Interlace		SD i					
			Composite					SD		
		DVCAM <sup>1)</sup>	HD SDI/Component						DV	
			SD SDI/Component				SD		DV	
			HD HDMI						DV	
			SD HDMI Progressive						DV	
			SD HDMI Interlace		SD i				DV	
			Composite					SD	DV	
	SP	HDV	HDV	HD SDI/Component			HD		HDV	
				SD SDI/Component			SD		HDV	
				HD HDMI		HD			HDV	
				SD HDMI Progressive		SD P			HDV	
				SD HDMI Interlace		SD i			HDV	
				Composite					SD	HDV
		DVCAM	DVCAM	DVCAM	HD SDI/Component					DV
					SD SDI/Component			SD		DV
					HD HDMI					DV
SD HDMI Progressive									DV	
SD HDMI Interlace						SD i			DV	
Composite									SD	DV
SD	SD	DVCAM	SD SDI/Component			SD		DV		
			SD HDMI Progressive					DV		
			SD HDMI Interlace		SD i			DV		
			Composite					SD	DV	

<sup>1)</sup>No DVCAM stream is output with HQ 1920/24P, HQ 1440/24P and HQ 1280/24P

**With an i.LINK input in Media mode**

- No signal is output from the SDI OUT and HDMI OUT connectors with an i.LINK input.
- DV and HDV inputs can be displayed on the LCD monitor/EVF screen even if the recording operation and/or output are limited.
- When “i.LINK I/O” is set to “Disabled,” i.LINK input is refused.
- If i.LINK input is refused, the screen becomes blue.

blank: no signal

Menu setting				Input	Output			
HD/SD Mode	Video Format	i.LINK I/O	Output Select	i.LINK	SDI OUT	HDMI OUT	COMPONENT OUT	A/V OUT
HD	HQ	HDV	HD SDI/Component	Refused			HD	
			SD SDI/Component	Refused			SD	
			HD HDMI	Refused				
			SD HDMI Progressive	Refused				
			SD HDMI Interlace	Refused				
			Composite	Refused				SD
		DVCAM	HD SDI/Component	DV				
			SD SDI/Component	DV				SD
			HD HDMI	DV				
			SD HDMI Progressive	DV				
			SD HDMI Interlace	DV				
			Composite	DV				SD
	SP	HDV	HD SDI/Component	HDV				HD
			SD SDI/Component	HDV			SD	
			HD HDMI	HDV				
			SD HDMI Progressive	HDV				
			SD HDMI Interlace	HDV				
			Composite	HDV				SD
		DVCAM	HD SDI/Component	DV				
			SD SDI/Component	DV				SD
			HD HDMI	DV				
SD HDMI Progressive			DV					
SD HDMI Interlace			DV					
Composite			DV				SD	

Menu setting				Input	Output			
HD/SD Mode	Video Format	i.LINK I/O	Output Select	i.LINK	SDI OUT	HDMI OUT	COMPONENT OUT	A/V OUT
SD	SD	DVCAM	SD SDI/Component	DV			SD	
			SD HDMI Progressive	DV				
			SD HDMI Interlace	DV				
			Composite	DV				SD

# Backup Battery

This camcorder uses a backup battery to retain various setting data.

A lithium battery (CR2032) for backup is mounted in the camcorder at the factory. The backup battery retains the date, time, and timecode in Free Run mode even when no operating power is being supplied.

## Service life of the backup battery

When the backup battery's voltage falls, the backup battery low-voltage warning appears on the LCD monitor/viewfinder screen. If this warning appears, replace the battery as soon as possible.

### WARNING

- Battery may explode if mistreated. Do not recharge, disassemble, or dispose of in fire.
- Batteries shall not be exposed to excessive heat such as sunshine, fire or the like.

### CAUTION

Danger of explosion if battery is incorrectly replaced. Replace only with the same or equivalent type recommended by the manufacturer.

When you dispose of the battery, you must obey the law in the relative area or country.

### AVERTISSEMENT

N'exposez pas les batteries à une chaleur excessive, au soleil ou près d'un feu par exemple.

### ATTENTION

Il y a danger d'explosion s'il y a remplacement incorrect de la batterie. Remplacer uniquement avec une batterie du même type ou d'un type équivalent recommandé par le constructeur. Lorsque vous mettez la batterie au rebut, vous devez respecter la législation en vigueur dans le pays ou la région où vous vous trouvez.

### WARNUNG

Akkus dürfen keinesfalls übermäßiger Wärmeeinwirkung ausgesetzt werden, wie z.B. Sonneneinstrahlung, Feuer o. ä.

### VORSICHT

Explosionsgefahr bei Verwendung falscher Batterien. Batterien nur durch den vom Hersteller empfohlenen oder einen gleichwertigen Typ ersetzen.

Wenn Sie die Batterie entsorgen, müssen Sie die Gesetze der jeweiligen Region und des jeweiligen Landes befolgen.

## Replacing the backup battery

### Notes

- Be sure to set the power switch to OFF when replacing the backup battery.
- Be careful not to drop the removed screw into the camcorder.

- 1 **Open the cover of the backup battery holder on the bottom by loosening the screw, and remove the battery.**

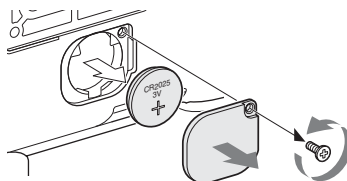

- 2 **Insert a new backup battery (CR2032) with the + symbol on the battery facing outside.**

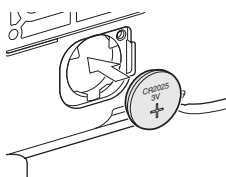

- 3 **Attach the cover in the original position.**

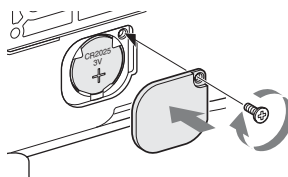

# Troubleshooting

## Operating Power

Symptoms	Cause	Remedy
The camcorder does not power on when you set the power switch either to CAMERA or MEDIA.	No battery pack is mounted and no power is supplied to the DC IN connector.	Mount a battery pack ( <i>page 26</i> ) or connect an AC power using the BC-U1/U2 ( <i>page 27</i> ).
	The battery pack is completely exhausted.	Replace the battery pack with a fully charged one ( <i>page 26</i> ).
The power supply cuts while operating.	The battery pack becomes exhausted.	Replace the battery pack with a fully charged one ( <i>page 26</i> ).
The battery pack becomes exhausted very quickly.	The ambient temperature is very low.	This owes to the battery characteristics and is not a defect.
	The battery pack is inadequately charged.	Recharge the battery pack ( <i>page 26</i> ). If the battery pack is soon exhausted even after you charged it fully, it may come to the end of its life. Replace it with a new one.

## Recording/Playback

Symptoms	Cause	Remedy
Recording does not start when you press the REC START/STOP button.	The power switch is set to OFF or MEDIA.	Set the power switch to CAMERA.
	The SxS memory card is write-protected.	Release the write protection ( <i>page 35</i> ), or replace the card with a non-protected SxS memory card.
	The SxS memory card is full.	Replace the card with one having sufficient space.
	The SxS memory card needs restoration.	Restore the memory card ( <i>page 37</i> ).
Playback does not start when you press the PLAY button.	The power switch is set to OFF or CAMERA.	Set the power switch to MEDIA.
The supplied IR Remote Commander does not work.	Remote control operation is disabled.	Enable remote control operation ( <i>page 33</i> ).
	The battery of the IR Remote Commander is exhausted.	Replace the battery with a new one.
Audio recording is not possible.	The AUDIO LEVEL (CH-1/CH-2) controls are set to the minimum level.	Adjust the audio recording levels with the AUDIO LEVEL (CH-1/CH-2) controls ( <i>page 65</i> ).
The recorded sound is distorted.	The audio level is too high.	Adjust the audio recording levels with the AUDIO LEVEL (CH-1/CH-2) controls ( <i>page 65</i> ), and record again.
The recorded sound has a high noise level.	The audio level is too low.	Adjust the audio recording levels with the AUDIO LEVEL (CH-1/CH-2) controls ( <i>page 65</i> ), and record again.

## External Devices

Symptoms	Cause	Remedy
The equipment connected to the camcorder via an i.LINK connection does not react as expected, for example, no picture appears on its screen.	It sometimes takes time for the connected equipment to recognize the operation.	Wait for about 15 seconds. If the connected equipment still does not react, do the following: <ul style="list-style-type: none"><li>• Check the i.LINK cable, for example, by re-plugging it.</li><li>• Turn the power off, and connect the cable again.</li><li>• Change the i.LINK cable.</li></ul>

# Error/Warning Indications

The camcorder informs you of situations where warning, caution, or an operation check is required, through messages on the LCD monitor/EVF screen, the tally lamps, and a buzzer.

The buzzer is output to the built-in speaker or to the headphones connected via the headphone connector. The buzzer volume can be adjusted with “Alarm Level” in “Audio Output” of the AUDIO SET menu.

## Error Indications

The camcorder stops operation after the following indications.

Error indication on LCD/EVF	Buzzer	Tally lamps	Cause and measures
E + Error code	Continuous	Rapidly flashing	The camcorder may be defective. Turn off the power and consult Sony service personnel. (If power cannot be turned off by setting the power switch to OFF, remove both the battery pack and the DC IN source.)

## Warning Indications

When one of the following indications is generated, follow the message to clear the problem.

Warning indication on LCD/EVF	Buzzer	Tally lamps	Cause and measures
Media Near Full	Intermittent	Flashing	Free space on the SxS memory card has become insufficient. Replace it with another at the earliest opportunity.
Media Full	Continuous	Rapidly flashing	No space is left on the SxS memory card. Recording, clip copying and clip division cannot be performed. Replace it with another.
Battery Near End	Intermittent	Flashing	The battery power will be exhausted soon. Charge the battery pack at the earliest opportunity.
Battery End	Continuous	Rapidly flashing	The battery pack is exhausted. Recording cannot be performed. Connect a power source via the DC IN connector or stop operation to charge the battery pack.
Temperature High	Intermittent	Flashing	The internal temperature has risen above a safe operation limit. Suspend operation, turn off the power, and wait until the temperature falls.
Voltage Low	Intermittent	Flashing	The DC IN voltage has become low (stage 1). Check the power supply.
Insufficient Voltage	Continuous	Rapidly flashing	The DC IN voltage is too low (stage 2). Recording cannot be performed. Connect other power source.
Battery Error Please Change Battery.			An error was detected with the battery pack. Replace the battery pack with a normal one.
Backup Battery End Please Change.			The remaining power of the backup battery is insufficient. Replace the battery with a new one.

<b>Warning indication on LCD/EVF</b>	<b>Buzzer</b>	<b>Tally lamps</b>	<b>Cause and measures</b>
Unknown Media(A) <sup>1</sup> Please Change.			A partitioned memory card or one that contains recorded clips exceeding the number permitted with this camcorder is loaded. This card cannot be used with this camcorder. Remove it and load a compatible card.
Media Error Media(A) <sup>1</sup> Needs to be Restored			An error occurred with the memory card. The card requires restoration. Remove the card, load it again, and restore it.
Reached Clip Number Limit Cannot Record on Media(A) <sup>1</sup>			The maximum number of clips for a single memory card is reached. No more clip can be recorded on the card. Replace it with another card.
Media Error Cannot Record to Media(A) <sup>1</sup>			Recording cannot be done, as the memory card is defective. As playback may be possible, it is recommended to replace it with another card after copying the clips, as required.
Media Error Cannot Use Media(A) <sup>1</sup>			Neither recording nor playback can be done, as the memory card is defective. It cannot be operated with this camcorder. Replace it with another card.
Cannot Use Media(A) <sup>1</sup> Unsupported File System			A card of a different file system or an unformatted card was inserted. It cannot be used with this camcorder. Replace it with another card or format it with this camcorder.
Video Format Mismatch			The external signal input via the i.LINK connection cannot be recorded, as the Video Format setting is different from the signal format of the external input signal. Change "Video Format" of the OTHERS menu to match it to that of the external signal.
Copy Protected Input Cannot Record			The external signal input via the i.LINK connection cannot be recorded, as the stream is copy-protected. Check the input signal.
DVCAM Input Signal! Cannot Record			The external signal input via the i.LINK connection cannot be recorded, as it is a DVCAM stream.
Media Error Playback Halted			An error occurred in reading data from the memory card, and playback cannot be continued. If this frequently occurs, change the memory card after copying the clips, as required.
Media(A) <sup>1</sup> Error			Recording cannot be done, as an error occurred with the memory card. If this frequently occurs, change the memory card.
HDD A <sup>2</sup> Battery Near End	Intermittent	Flashing	The battery power of the connected HDD will be exhausted soon. Change the battery at the earliest opportunity.
HDD A <sup>2</sup> Battery End	Continuous	Rapidly flashing	The battery of the connected HDD is exhausted. Recording cannot be performed. Stop operation to change the battery.
Not Enough Capacity Change Media (A) <sup>1</sup>			There is not enough capacity for copying. Replace the card with another one.
Reached Duplication Limit Change Media (A) <sup>1</sup>			The card have already ten clips having the same name as that you tried to duplicate. Replace the card with another one.

Warning indication on LCD/EVF	Buzzer	Tally lamps	Cause and measures
Not Enough Capacity Cannot Divide			There is not enough capacity for dividing a clip.
Media Reached Rewriting Limit Change Media (A) <sup>1)</sup>			The memory card comes to the end of its service life. Make a backup copy and replace the card with another one as soon as possible. Recording/playback may not be performed properly if you continue to use the card.  <i>For details, refer to the operating instructions of the memory card.</i>

1) (B) for the card in slot B

2) B for a HDD connected to slot B



# MPEG-2 Video Patent Portfolio License

ANY USE OF THIS PRODUCT OTHER THAN CONSUMER PERSONAL USE IN ANY MANNER THAT COMPLIES WITH THE MPEG-2 STANDARD FOR ENCODING VIDEO INFORMATION FOR PACKAGED MEDIA IS EXPRESSLY PROHIBITED WITHOUT A LICENSE UNDER APPLICABLE PATENTS IN THE MPEG-2 PATENT PORTFOLIO, WHICH LICENSE IS AVAILABLE FROM MPEG LA, L.L.C., 250 STEELE STREET, SUITE 300, DENVER, COLORADO 80206.

“PACKAGED MEDIA” means any storage media storing MPEG-2 video information such as DVD movie which are sold/distributed to general consumers. Disc replicators or sellers of the PACKAGED MEDIA need to obtain licenses for their own business from MPEG LA. Please contact MPEG LA for any further information. MPEG LA, L.L.C., 250 STEELE STREET, SUITE 300, DENVER, COLORADO 80206 <http://www.mpegla.com>

# Specifications

## General

### Power requirements

DC 12 V (10.5 V to 17.0 V)

### Power consumption

Approx. 12.5 W (Typical) (Recording, EVF On, LCD monitor Off)

Max. 14 W (Typical) (Recording, EVF On, LCD monitor On)

### Peak inrush current

(1) Power ON, current probe method:

15 A (240V)

(2) Hot switching inrush current, measured in accordance with European standard EN55103-1:

62 A (230V)

### Operating temperature

0°C to +40°C (32°F to 104°F)

### Storage temperature

-20°C to +60°C (-4°F to 140°F)

### Recording/playback formats

#### Video

HD HQ Mode: MPEG-2 MP@HL,  
35 Mbps / VBR

1920 × 1080/59.94i, 50i, 29.97P, 25P,  
23.98P

1440 × 720/59.94P, 50P, 29.97P, 25P,  
23.98P

1280 × 720/59.94P, 50P, 29.97P, 25P,  
23.98P

HD SP Mode: MPEG-2 MP@H-14,  
25 Mbps /CBR

1440 × 1080 /59.94i, 50i (23.98P is  
converted to 59.94i in 2-3 pull-  
down processing.)

SD Mode: DVCAM

720× 480/59.94i, 29.97P

720× 576/50i, 25P

**Audio**

LPCM (16 bits, 48 kHz, 2 channels)

**Recording/playback time**

With one SBP-8

SP or DVCAM mode: Approx. 35 min.

HQ mode: Approx. 25 min.

With one SBP-16

SP or DVCAM mode: Approx. 70 min.

HQ mode: Approx. 50 min.

With one SBP-32 or SBS-32G1

SP or DVCAM mode: Approx.

140 min.

HQ mode: Approx. 100 min.

**Note**

The actual recording/playback time may differ slightly from the values shown here, depending on usage conditions, memory characteristics, etc.

**Continuous operation time**

(Recording, EVF On, LCD monitor Off)

With the BP-U60

Approx. 4 hours

With the BP-U30

Approx. 2 hours

**Mass**

Camcorder: 2.4 kg (5 lb 4.7 oz)

With the supplied lens hood, eyecup,

BP-U30 battery pack and one SxS memory card: 2.8 kg (6 lb 2.8 oz)

**Dimensions**

See page 163.

**Supplied accessories**

See page 12.

**Camera Block****Lens****Focal length**

5.8 mm to 81.2 mm (equivalent to

31.4 mm to 439 mm on 35 mm lens)

**Zoom**

Servo/Manual selectable

**Zoom ratio**

14x

**Maximum relative aperture**

1:1.9

**Iris**

Auto/Manual selectable

F1.9 to F16 and C (close)

**Focus**

Auto/Manual selectable

Ranges:

800 mm to ∞ (Macro OFF)

50 mm to ∞ (Macro ON, Wide)

735 mm to ∞ (Macro ON, Tele)

**Picture stabilizing function**

SteadyShot ON/OFF possible, shift-lens system

**Filter thread**

M77 mm, pitch 0.75 mm

**Macro**

ON/OFF switchable

**Camera****Pickup device**

1/2-inch type, CMOS image sensor

Effective picture elements:

1920 (H) × 1080 (V)

**Format**

3-chip RGB

**Optical system**

F1.6 prism system

**Built-in filters**

ND filters

OFF: Clear

1: 1/8ND

2: 1/64ND

**Sensitivity**

F10 (Typical) (With 1920/60i, 89.9% reflection, 2000 lx)

**Minimum illumination**

0.14 lx (F1.9, +18 dB, 64-frame accumulation)

**Video S/N**

54 dB (Y) (Typical)

### Horizontal resolution

1000TV lines or more (with HQ 1920,  
HD SDI output)

### Gain

-3, 0, 3, 6, 9, 12, 18 dB, AGC

### Shutter speed

$\frac{1}{32}$  to  $\frac{1}{2000}$  sec.

### Slow shutter

2 to 8 frames

EX Slow Shutter: 16, 32, 64 frames

## Audio Block

### Built-in microphones

Stereo electret condenser microphones

Directivity: Omnidirectional

Frequency response: 50 Hz to 15 kHz

### Built-in speaker

Monaural

Output: 250 mW

## Displays

### LCD monitor

#### Screen size

8.8 cm diagonal (3.5-inch)

#### Aspect ratio

16:9

#### Picture size

640 (H) × 3 (RGB) × 480 (V) delta  
sequence

#### Transmission

Hybrid (semi-transmissive) type

### Viewfinder

#### Screen size

1.148 cm diagonal (0.452-inch)

#### Aspect ratio

16:9

#### Picture elements

852 (H) × 480 (V)

## Media Block

### Card slots

Type: Express Card34

Number of slots: 2

Connector: Conforming to PCMCIA  
Express Card

### Writing rate

50 Mbps or more

### Reading rate

50 Mbps or more

## Inputs/Outputs

### Input connectors

#### AUDIO IN CH1/CH2 connectors

XLR 3-pin (2), female

LINE: +4 dBu

MIC: -20 dBu to -65 dBu (3-dB steps)  
(Reference level: 0 dBu=0.775 Vrms)

#### DC IN connector

DC jack (1)

### Output connectors

#### A/V OUT connector

AV multiconnector (1)

Audio: -10 dBu (47kΩ load, reference  
level)

Analog composite: NTSC or PAL

#### COMPONENT OUT connector

Mini D connector (1)

Y: 1.0 Vp-p, 75Ω

Pb / Pr: 0.7 Vp-p, 75Ω

#### Headphone connector

Stereo mini jack (1), -18 dBu (reference  
level output, 16Ω load)

#### SDI OUT connector

BNC type (1), conforming to

SMPTE 292M/259M standards

#### HDMI OUT connector

Type A (1)

## Computer connectors

### i.LINK (HDV/DV) connector

i.LINK, IEEE1394, 4-pin connector (1), S400

### USB connector

mini-B/USB2.0 Hi-Speed (1)

## Optional Accessories

### Battery pack

BP-U30, BP-U60

### Battery charger

BC-U1, BC-U2

### SxS memory card

SxS PRO SBP-8 (8 GB)

SxS PRO SBP-16 (16 GB)

SxS PRO SBP-32 (32 GB)

SxS-1 SBS-32G1 (32 GB)

SxS memory card USB reader/writer  
SBAC-US10

Mobile storage unit

PXU-MS240

Media Adaptor

MEAD-MS01 (for “Memory Stick PRO-HG Duo HX” series)

MEAD-SD01 (for SDHC card)

Electret condenser microphone

ECM-673, ECM-680S

Wireless microphone

UWP-V1

Wide conversion lens

VCL-EX0877

Professional hard disk unit

PHU-60K, PHU-120K, PHU-120R

Design and specifications are subject to change without notice.

## Dimensions

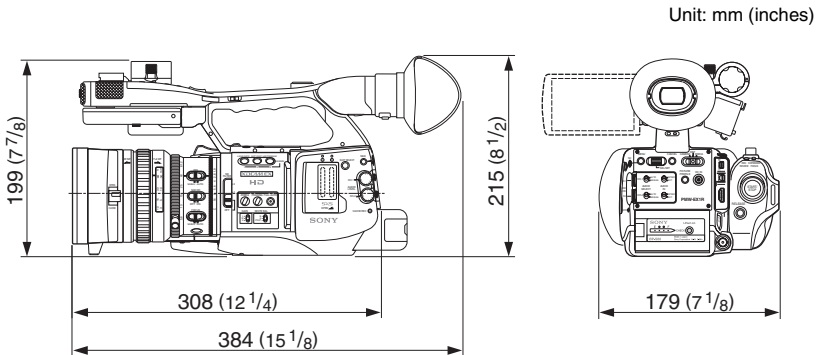

### Notes

- Always make a test recording, and verify that it was recorded successfully. SONY WILL NOT BE LIABLE FOR DAMAGES OF ANY KIND INCLUDING, BUT NOT LIMITED TO, COMPENSATION OR REIMBURSEMENT ON ACCOUNT OF FAILURE OF THIS UNIT OR ITS RECORDING MEDIA, EXTERNAL STORAGE SYSTEMS OR ANY OTHER MEDIA OR STORAGE SYSTEMS TO RECORD CONTENT OF ANY TYPE.
- Always verify that the unit is operating properly before use. SONY WILL NOT BE LIABLE FOR DAMAGES OF ANY KIND INCLUDING, BUT NOT LIMITED TO, COMPENSATION OR REIMBURSEMENT ON ACCOUNT OF THE LOSS OF PRESENT OR PROSPECTIVE PROFITS DUE TO FAILURE OF THIS UNIT, EITHER DURING THE WARRANTY PERIOD OR AFTER EXPIRATION OF THE WARRANTY, OR FOR ANY OTHER REASON WHATSOEVER.

# Index

## Numerics

24P System 125

## A

A/V OUT connector 136  
AC adaptor 27  
AC power source 27  
ACCESS lamps 35, 36  
accessory shoe 19, 38  
add shot marks 107  
AF mode 59  
AGC mode 51  
All Clips CPY 104  
All Clips DEL 92  
All Reset 93, 129  
All-Clip thumbnail screen 96  
Angle mode 52  
Area Detection 91  
Aspect Marker 49  
Aspect Mask 49  
Aspect Select 49  
Assign Button 69, 130  
assignable buttons 69  
ATW 47, 70  
ATW Hold 70  
ATW Speed 122  
Audio 64  
AUDIO IN connectors 64  
AUDIO IN switches 64  
Audio Input 123  
AUDIO LEVEL controls 64  
audio monitoring 66  
Audio Output 123  
audio recording levels 65  
AUDIO SELECT switches 64  
AUDIO SET Menu 123  
AUDIO Status 111  
Auto Focus 57  
Auto Iris mode 54  
Auto Shutter 53  
Auto Shutter mode 52  
Auto Tracing White 47

Auto White Balance 48

## B

Backlight 70  
backlight (EVF) 31  
backlight (LCD) 30  
backup battery 154  
BARS/CAM button 66  
Battery Alarm 131  
Battery INFO 131  
BATTERY INFO display 27  
Battery Pack 26  
BATTERY RELEASE button 26  
BATTERY/MEDIA Status 113  
BC-U1 Battery Charger 26  
BC-U1/U2 28  
Black 91  
Black Gamma 91  
BP-U30 26  
BP-U60 26  
BRT DISP 69  
BRT Disp 70  
built-in clock 29  
Built-in microphones 64  
Built-in speaker 98  
BUTTON/REMOTE Status 112  
Buzzer 157

## C

CACHE REC lamp 74  
Camera Data 93, 129  
Camera mode 28  
CAMERA SET Menu 118  
CAMERA Status 110  
CANCEL button 101, 115  
Card slots 35  
Center Marker 49  
Clip 44, 133  
CLIP INFO screen 102  
clip name 44  
Clip Operation menu 100, 101  
Clock mode 61  
Clock Set 129  
CMOS Image Sensors 144  
color bar 66  
Color Bar Type 119  
Color Correction 87

COMPONENT OUT connector 136  
copy a clip 103  
COPY CLIP 103  
Country 132  
Cueing up 99

## D

Date/Time 29  
DC IN connector 28  
DC IN Power 27  
delete a clip 104  
DELETE CLIP 104  
delete shot marks 107  
Deleting Clips 92  
Detail 88  
DF 62  
diopter compensation 31  
Direct Menu 131  
Direct menu 24, 47, 51, 54, 59, 60, 75,  
85  
DISP CLIP INFO 102  
Display On/Off 127  
DISPLAY/BATT INFO button 23, 27  
divide a clip 108  
DIVIDE CLIP 108  
Down Converter 125

## E

ECS 52  
ECS Frequency 53  
EJECT buttons 35  
electronic shutter 52  
Electronic Viewfinder 31  
Entering a character string 117  
Error Indications 157  
EVF 31, 125  
EVF Mode 70  
EX Slow Shutter 52, 53, 118  
EXPAND CLIP 105  
EXPAND CLIP screen 105  
EXPAND FOCUS button 57  
Expanded Focus 70  
ExpressCard slot of a computer 137  
Extended Clear Scan 52  
External Hard Disk 38  
external microphone 64  
external monitor 135

eyecup 32  
Eyepiece focusing knob 31

## F

F FWD button 98  
F REV button 98  
Fade In 82, 83  
Fade Out 82, 83  
Fader 70, 82, 121  
Fixed gain mode 51  
Fixed Shutter mode 52  
Flicker Reduce 60, 119  
focus 57  
Focus ring 57  
Format Media 37, 39, 41, 133  
Formatting 36  
Frame Rec 120  
Frame Recording 72  
Free Run mode 61  
Freeze Mix 70, 77  
FULL AUTO button 42  
Full Auto mode 42  
Full Manual Focus 57  
Full MF mode 57

## G

gain 51  
Gain Setup 51, 118  
GAIN switch 51  
Gamma 91  
Grip 32  
Guide Frame 50

## H

HD/SD Mode 44, 132  
HDMI OUT connector 136  
Headphone connector 65, 98  
high-speed playback 98  
HISTOGRAM 69  
Histogram 70  
Hooks for the shoulder strap 19  
Hours Meter 130

## I

i.LINK 142  
i.LINK cable 142  
i.LINK I/O 131, 139

i.LINK(HDV/DV) connector 139  
Image Inversion 122  
index frame 108  
index frame image 94  
Interval Rec 120  
Interval Recording 70  
IR Remote 33, 70, 131  
IR Remote Commander 33  
iris 54  
IRIS button 54  
iris opening 54  
Iris ring 54  
IRIS switch 54

## J

Jog dial 21, 115  
Joystick 20, 115

## K

Knee 90

## L

Language 129  
Last Clip DEL 70, 92  
LCD 30, 125  
LCD B.LIGHT switch 30  
LCD BRIGHT buttons 30  
LCD monitor 30  
LCD/VF SET Menu 125  
lens cap 42  
Lens hood 18  
LENS INFO 69  
Lens Info 70  
LENS REMOTE connector 56  
LINE/MIC/MIC+48V switches 64  
Low Key SAT 91

## M

Macro mode 59  
MACRO switch 59  
Manual Focus 57  
Manual Iris mode 54  
Manual Zoom mode 55  
Marker 49, 70, 126  
Matrix 87  
MEAD-MS01 41  
MEAD-SD01 41

MEDIA 94  
Media Adaptor 41  
Media Full 37  
Media mode 28  
Media Near Full 37  
Memory Stick 41  
MENU button 115  
Menu controls 115  
MF Assist 58, 119  
MF mode 58  
microphone holder 64  
MONITOR VOL buttons 65, 98

## N

ND filter switch 46  
ND filters 46  
NDF 62  
NEXT button 99  
NTSC Area 44

## O

OK mark 67, 103  
OK MARK ADD 103  
OK MARK DEL 103  
OK-Clip thumbnail screen 96  
One-Push Auto Focusing 58  
OTHERS Menu 129  
Output Formats 145  
Output Select 124, 135, 136

## P

P.Cache Rec 73, 120  
PAL Area 45  
Pausing 98  
Peaking 58, 125  
PEAKING button 58  
PHU-60K/120K/120R 38  
Picture Cache 70  
Picture Cache Recording 73  
PICTURE FROFILE menu 84, 87  
PICTURE PROFILE button 84  
Picture Profiles 84  
PLAY/PAUSE button 97  
Power switch 28  
Power Zoom 55  
Power Zoom (Servo) mode 55  
Power zoom lever 56

PREV button 99  
Profile Name 87  
PUSH AF button 58

## R

Range index 57  
Rec 70  
REC HOLD lever 43  
Rec Review 43, 68, 70, 120  
REC REVIEW button 43, 68  
Rec Run mode 61  
REC START/STOP button 43  
Recall 93  
reference tone 66  
Regen mode 61  
RELEASE button 32  
restoration 38

## S

S&Q Motion 75, 120  
Safety Area 49  
Safety Zone 49  
SBAC-US10 137  
SD Detail 89  
SDHC card 41  
SDI OUT connector 135  
SEL/SET button 115  
SEL/SET dial 115  
SET INDEX PIC 108  
Setup 124  
setup file 93  
Setup menus 114  
Shockless White 122  
SHOT MARK 106  
SHOT MARK screen 106  
SHOT MARK1 106  
Shot Mark1 70  
SHOT MARK1 ADD 107  
SHOT MARK1 DEL 107  
SHOT MARK2 106  
Shot Mark2 70  
SHOT MARK2 ADD 107  
SHOT MARK2 DEL 107  
shot marks 67, 99  
Shot Transition 78, 119  
Shutter 52, 118  
SHUTTER switch 52

Skin Tone Detail 90  
SLOT SELECT button 35, 96  
Slow & Quick Motion 75  
Slow Shutter 52  
SLS 52  
Speed mode 52  
Spotlight 70  
STATUS button 109  
status screens 109  
Steady Shot 60, 122  
STOP button 98  
Store 93  
SxS Device Driver Software 16, 137  
SxS memory card 34

## T

Tally 130  
Tally lamps 157  
TC Format 62, 128  
TC/UB SET Menu 128  
TC/U-BIT/DURATION button 63, 97  
THUMBNAIL button 96, 98  
Time Zone 29, 129  
Timecode 128  
TLCS 24, 43, 121  
TRANSITION operation buttons 78  
Trigger Mode 131  
Tripod receptacle 22  
Troubleshooting 155

## U

USB cable 137  
user bits 63  
Users Bit 128  
UTC 29

## V

Version 133  
Version Up 134  
Video Format 44, 132  
Video Out Display 124, 136  
VIDEO SET Menu 124  
VIDEO Status 112  
Viewfinder 31  
Viewfinder release lever 143

## **W**

Warning Indications 157  
White 88  
WHITE BAL switch 47  
white balance 47  
White Switch 122  
WHT BAL button 48  
Wide Conversion 60, 122  
wide-conversion lens 60  
write protection 35

## **X**

XDCAM EX Clip Browsing Software 16,  
138  
XDCAM Transfer 139

## **Y**

YPbPr/Digital Out Display 124, 135, 136

## **Z**

Zebra 50, 126  
ZEBRA button 50  
zebra patterns 50  
Zebra Select 50  
Zebra1 Level 50  
zoom 55  
ZOOM button 56  
Zoom Position 55  
Zoom ring 55  
Zoom Speed 119  
Zoom speed switch 56  
ZOOM switch 55  
Zoom Trans 56, 120





