

The following features are available in this PDF document.



### **Quick Keyword Search**

Enter the keyword in the search box and hit the search button



### **Quick Jump between Chapters**

Click the title of a specific chapter on the Contents to jump to it

\*Reading software such as Adobe Reader is needed to support the functions above.



# CRANE 2S

User Guide

# Contents

■ Packing list	
Packing list.....	1
■ Get to know the CRANE 2S	
Get to know the CRANE 2S.....	2
Port introduction.....	3
■ Charging and Battery	
Charger and battery description.....	4
Charging Procedure.....	5
■ Installation and Balance Adjustment	
Installing the battery.....	6
Installing the tripod.....	6
Installing the quick release base plate.....	6
Installing the camera.....	7
Connecting the control cable.....	8
Balance adjustment.....	9
■ Using the CRANE 2S	
Quick Release Plate Adjustment Module.....	12
How to use the hex wrench.....	13
Control panel description.....	13
Display screen description.....	15
Menu options description.....	17
Motor Torque Adjustment.....	19
Operation Modes.....	20
Manual Repositioning.....	24

■ How to Use the App	
App Download .....	25
Connect and activate.....	25
■ APP Operations	
Main App Features .....	26
■ Calibration and firmware upgrade	
When is Calibration Required .....	27
How to initialize.....	27
How to perform six-side calibration.....	28
Motor Fine-tuning .....	30
CRANE 2S firmware upgrade.....	30
■ Product Specifications	
■ Disclaimer and Warnings	
Reading Tips.....	33
Warnings.....	33
Safe Operation Guidelines .....	34
■ Warranty Terms	
Warranty Period .....	37
Warranty Exclusions.....	37
Warranty Claim Procedure.....	37
■ Contact Card	

## Packing list

The product package comes with the following items. If there are any missing items, please contact ZHIYUN or your local distributor.

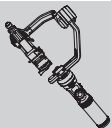

CRANE 2S x 1



Quick release plate x 1



Camera Backing Base x 1



Tripod x 1

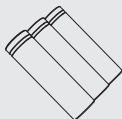

18650 lithium battery x 3



Charger x 1



Wrench x 3



1/4-20 screw x 3

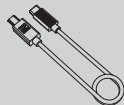

Type-C to Micro USB camera control cable x 1

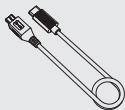

Type-C to Mini USB camera control cable x 1

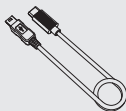

Type-C to Type-C camera control cable x 1

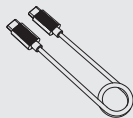

Type-C to Multi-USB camera control cable x 1

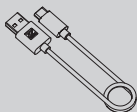

USB Type-C Cable x 1



Quick Start Guide x 1

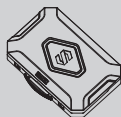

Storage case x 1

## Get to know the CRANE 2S

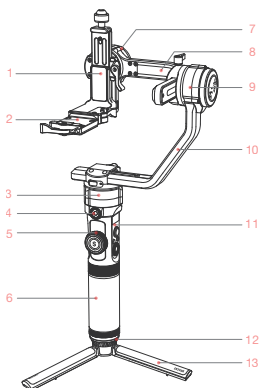

1. Tilt axis
2. Quick release base
3. Pan axis motor
4. 1/4" screw thread with crown gear
5. Follow focus wheel
6. Handle
7. Tilt axis motor
8. Roll axis
9. Roll axis motor
10. Pan axis
11. Control panel
12. 1/4 threaded hole (compatible with 3/8)
13. Tripod

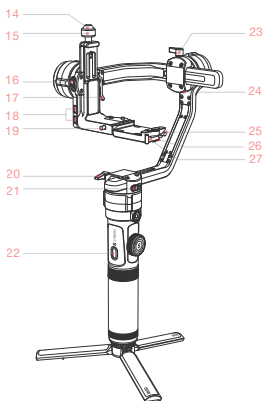

14. Vertical shooting safety lock
15. Vertical shooting locking screw
16. Tilt axis locking switch
17. Tilt axis locking latch
18. Type-C port for TransMount Follow Focus Motor × 2
19. Quick release base safety lock
20. Pan axis locking screw
21. Pan axis locking switch
22. Trigger button
23. Roll axis locking screw
24. Roll axis locking switch
25. Quick release plate safety lock
26. Quick release plate adjustment module
27. Quick release plate locking latch

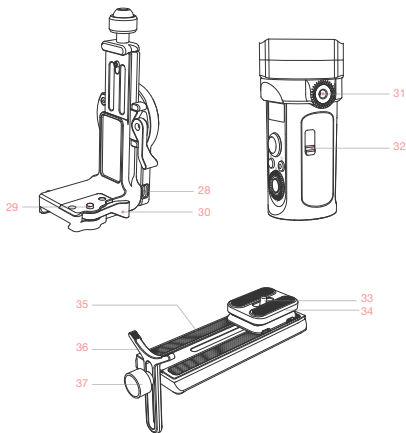

- 28. Type-C camera control port
- 29. Quick release base adjustment module
- 30. Quick release base locking latch
- 31. 1/4" screw thread with crown gear
- 32. Type-C firmware update port
- 33. 1/4 camera locking screw
- 34. Camera backing base
- 35. Quick release plate
- 36. Lens support
- 37. Locking screw for lens support

### Port introduction

Serial No.	Port type	Function	Output	Input
1	Type-C camera control port	Camera connection and control	5V1A	NA
2	Type-C port for TransMount Follow Focus Motor	TransMount Zoom or Focus Motors connection and control	8.7V2A	NA
3	firmware update port	Connect to the computer to upgrade the CRANE 2S firmware	/	/

Before using the CRANE 2S for the first time, use the charging device provided in the package to fully charge the batteries so as to activate them and ensure the smooth use of the product.

### Charger and battery description

#### Charger specifications

Name: 18650 Li-ion battery (three slots)

Model: CH18650-3B

Input: 5V=2400mA

Output: 4.2V=800mA × 3

● The LED indicator shines solid red when charging.

● The LED indicators shines solid blue when fully charged.

#### Battery specifications

Name: 18650 Li-ion battery

Model: INR 18650-26EC

Capacity: 2600mAh

Voltage: 3.7V

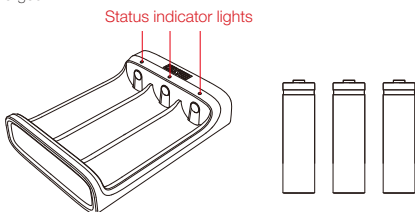

- ⚠** ① The stabilizer is equipped with batteries of high energy density, which may cause fire, economic loss or personal injury when improperly stored or handled. Please read the disclaimer and warning herein as well as the description on the battery label carefully before using the batteries.
- ② Please use batteries provided or approved by ZHIYUN only. ZHIYUN will not take any responsibility for explosion, fire and/or accidents caused by non-ZHIYUN batteries.

When the batteries are not in use, please make sure to put them in the battery slot of the package or in plastic storage cases (the storage case needs to be purchased separately).

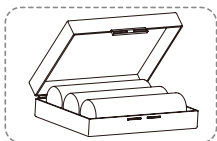
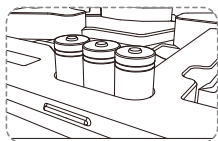

## Charging Procedure

1. Insert the batteries into the charger in the right direction(positive/negative end) accordingly.
2. Connect the charger to the adapter via the USB Type-C cable.
3. Plug the adapter into a power outlet to start charging.

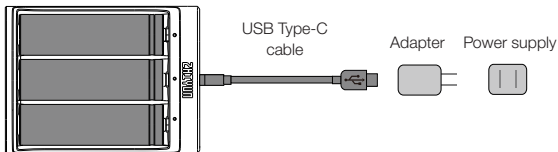

- ① Due to the differences of the charger itself, charging the batteries may fail when the power supply is insufficient (for instance, when the current of the adapter is lower than 500mA). Conditions may vary depending on the specific chargers used. It is recommended to use an adapter with a higher current capacity.
  - ② The battery cannot be charged through the Type-C port on the stabilizer.
- !**
- ① Please use a qualified standard 5V/  $\geq 2000\text{mA}$  adapter for battery charging; charging time depends on the maximum input current of the adapter.
  - ② This stabilizer comes standard with three high-discharge-rate ZHIYUN batteries. Use ZHIYUN batteries only.
  - ③ Please make sure the three batteries are fully charged. Undercharged batteries can cause stabilizer malfunction.

## Installing the battery

Unscrew the rear cover of the handle and install three original 18650 Li-ion batteries (note the direction of the positive and negative poles of the batteries). Then, tighten the rear cover of the handle.

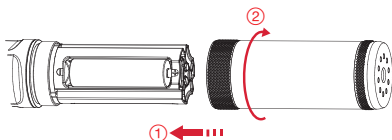

## Installing the tripod

Screw the tripod to the base of the CRANE 2S handle, then unfold the tripod and place the CRANE 2S on a flat surface.

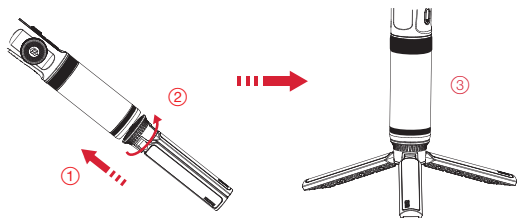

## Installing the quick release base plate

Take out the quick release base and push the quick release base into the CRANE 2S tilt arm. The detachable design means that you can quickly dismount the camera from the CRANE 2S. The rear of the quick release base contains three 1/4 screw holes making it easy for you to mount the entire quick release base to other devices.

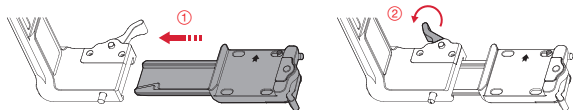

## Installing the camera

1. Mount the camera on the camera backing base and quick release plate, and tighten the bottom screw. Mount the lens support to the front end of the quick release plate and tighten the screw.

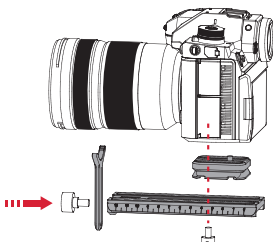

 You may decide whether or not to use the camera backing base depending on your camera-lens combo. You will need the camera backing base in the following situations:

- ① When using smaller and lighter cameras, such as the Sony 6000 series cameras.
  - ② When using lenses with larger diameters, such as the Canon RF28-70mm F2 L USM lens.
  - ③ When installing the TransMount Follow Focus Motor.
  - ④ If it is difficult to balance the roll axis when the camera is mounted vertically.
2. Adjust the lens support on the quick release plate so that it can hold the lens. Ensure that the lens is stable.
  3. Install the quick release plate with the mounted camera onto the gimbal, and lock the quick release plate.

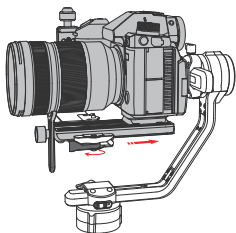

Horizontal mount

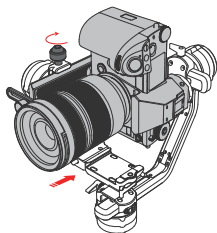

Vertical mount

 To avoid mechanical noises from the gimbal, tighten the vertical locking screw when mounting in horizontal mode; when mounting in vertical mode, tighten the quick release base locking latch; and you may choose whether or not to install the quick release base depending on the shooting conditions.

## Connecting the control cable

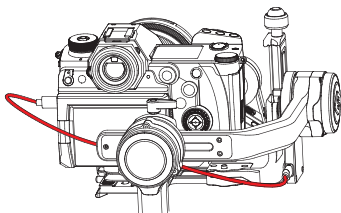

Control cable name	Type-C to Micro USB LN-MBUC-A01		Type-C to Mini USB LN-NBUC-A01		Type-C to Type-C LN-UCUC-A01		Type-C to Multi USB LN-UCUS-A01
Camera interface type	Micro USB		Mini USB		Type-C		Multi USB
Camera brand and model	Nikon		Canon		Panasonic	Nikon	Sony
	D850	5D Mark IV	6D Mark II	EOS R	GH5	Z6	A7RM3
Take photo	√	√	√	√	√	√	√
Take video	√	√	√	√	√	√	√
Live Preview	√	√	√	×	×	×	×
AV	√	√	√	√	√	√	×
TV	√	√	√	√	√	√	×
ISO	√	√	√	√	√	√	×
EV	√	√	√	√	√	√	×
Electronic Focus	√	√	√	√	√	√	×
Digital zoom	×	×	×	×	×	×	√

Method to select a camera manufacturer:

Press the menu button, turn the dial to "Camera Settings", and press the right button once to access camera settings. Turn the dial again to select the corresponding camera brand, and press the right button once to confirm.

- ① The table uses only some camera models as examples, and should only be taken as a reference. For the full and latest list of camera models supported by the CRANE 2S, check out the "CRANE 2S Camera Compatibility List" on ZHIYUN's official website at [www.zhiyun-tech.com](http://www.zhiyun-tech.com).
- ② When using the CRANE 2S with a Sony camera, connect the control cable and turn on the CRANE 2S before turning on the camera. Ensure that the camera has sufficient power. You may use a motorized lens that supports optical zoom, or a non-motorized lens that supports digital zoom. The lens type can be set in the camera menu.

## Balance adjustment

- ① The CRANE 2S has three lock switches corresponding to each of the three motor shafts. You can lock the CRANE 2S in the mounting or storage position for your convenience. Make sure that the three lock switches are unlocked when powering on to increase stability. Before balance adjustment, you can lock the CRANE 2S in the mounting position and release the locks of each axis in stages to facilitate balance adjustment.

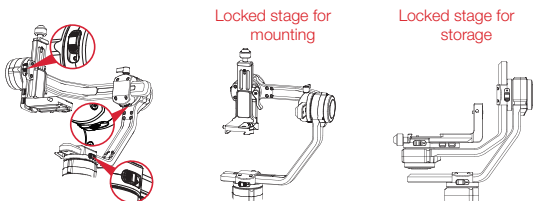

- ② Place the camera handle close to the tilt axis motor for optimal stability. Loosen the quick release base locking latch and push the entire quick release base so that the camera handle is close to the tilt axis motor before locking the latch.

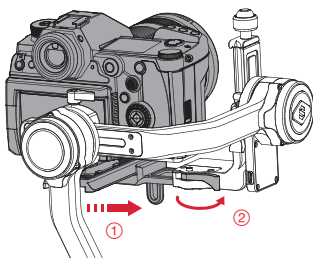

- 1. Tilt axis horizontal balance adjustment.** Unlock the tilt axis and Quick Release Plate Latch, push the camera to move forward or backward until the camera can stay still and almost level with its lens facing front (as shown below). Complete this step by tightening up Quick Release Plate Latch.

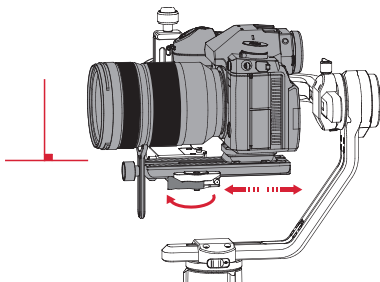

- 2. Tilt axis vertical balance adjustment.** Make the lens face up, slightly loosen the thumb screw of the tilt axis, and push the camera to move upward or downward until the camera can stay still with the lens facing up. Complete this step by tightening up the thumb screw.

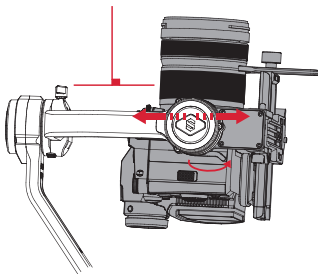

- 3. Roll axis balance adjustment.** Unlock the roll axis, and slightly loosen the roll axis thumb screw under the quick release plate, push the camera to move left or right until the camera can stay still and horizontal to the ground. Complete this step by tightening up thumb screw.

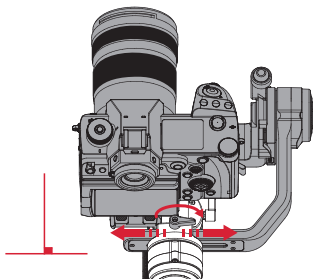

- 4. Pan axis balance adjustment.** Unlock the pan axis, slightly loosen the thumb screw on it, then adjust the pan axis until it stays still and horizontal to the ground. Complete this step by tightening up thumb screw.

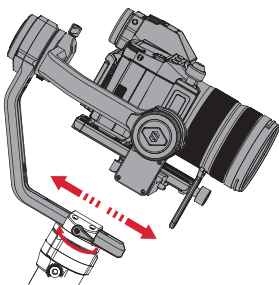

## Quick Release Plate Adjustment Module

1. Due to mechanical friction wear after a long time of use, the quick release plate locking latch (quick release base locking latch) can still move back and forth (left and right) after has been locked.

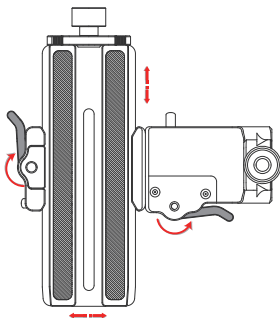

2. Now, you can keep pushing the adjustment module as shown in ①, adjust the latch until it is loosened as shown in ②, then let go of the adjustment module as shown in ①. Then, tighten the latch to ensure that the quick release plate (quick release base) is properly locked. If it fails to lock the first time, you may repeat the process several times until it is locked

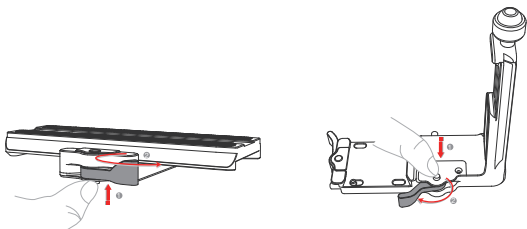

### How to use the hex wrench

This product comes with hex wrenches in three sizes. The M1.5 and M2 wrenches can be used for routine maintenance of the CRANE 2S. Tighten the screws as necessary when they become loose. The M4 wrench can be used to lock the 1/4 screw of the quick release plate.

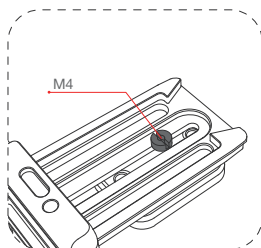
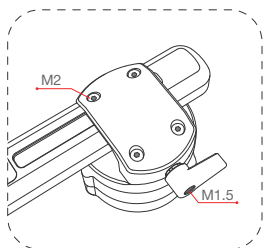

### Control panel description

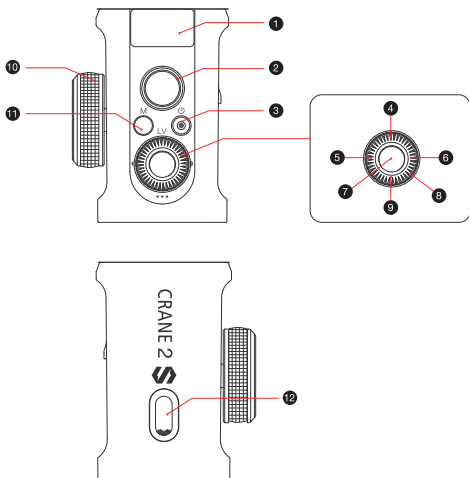

### ① Display screen

- Displays status information and camera control parameters for the CRANE 2S (see display screen description for details).

### ② Stabilizer joystick

- Push the joystick up and down, and left and right to control the stabilizer movement (does not work in PhoneGo mode or Point of View mode).

### ③ Power button/record button

- Long press the power button for three seconds to turn the CRANE 2S on or off.
- Press once to start/stop recording.

### ④ LV button

- Press once to access/exit live view mode on the DSLR.

### ⑤ Left selection button

- Press to switch to the previous control item in the main interface.
- Press to return to the previous menu level in the menu interface.
- Controls the camera's electronic zoom when mounted with a Sony camera.

### ⑥ Right selection button

- Press to switch to the next control item in the main interface.
- Press to confirm selection in the menu interface.
- Controls the camera's electronic zoom when mounted with a Sony camera.

### ⑦ Photo button

- Half press this button to activate auto camera focus.
- Full press this button to take a photo.

### ⑧ Dial

- Turn the dial to adjust camera parameters

in the main interface.

- Rotate the dial to move up and down in the menu interface.

### ⑨ Menu button

- Press to access or exit menu options.

### ⑩ Follow focus wheel

- The dial either controls the rotation of the electronic follow focus or TransFollow Focus Motor - you can select one in the menu.

### ⑪ M button

- Press the M button and the CRANE 2S will switch between Pan Following mode and Locking mode (Pan Following mode is the default mode after powering on).
- Press the M button twice and the CRANE 2S will switch between Point of View mode and Vortex mode. Press the M button again to return to Pan Following mode.
- Press the M button thrice and the CRANE 2S will enter Phone Go mode. Press the M button again to return to Pan Following mode.
- Long press the M button and the CRANE 2S will enter or exit Standby mode.

### ⑫ Trigger button

- Press or press and hold to enter Following mode (you can select this in the menu). Press again or release the button to return to the previous mode.
- Press twice and the motor will return to the initial point of the current mode (this will not work in Phone Go mode or Point of View mode).
- Press thrice to rotate the pan axis motor 180°. The current mode remains unchanged (this does not work in Locking mode).

 \*For installation instructions for TransMount Follow Focus Motor, refer to the instruction manual that comes with TransMount Follow Focus Motor.

- ① When starting the CRANE 2S, hold the camera gently to prevent possible malfunctions of the CRANE 2S, which may cause it to turn randomly, resulting in damage to the camera.
- ② When starting the CRANE 2S, hold the handle or place the CRANE 2S on a desktop. Shaking the CRANE 2S during startup may cause startup failure; do not leave the handle suspended in the air.

## Display screen description



Camera parameters are not adjustable



Camera parameters are adjustable



Sony camera connection control interface

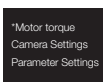

Menu interface



Activation prompt interface









Standby interface



Axis lock prompt interface

## Icon description:

	Camera successfully connected to gimbal
	Camera is in video mode
	Camera is in photo mode
	Current battery level
 axis lock	Indicates that the locks on the three axes have not been released and an alarm will sound (release the locks, and press and hold the M button to resume operation)
	Standby icon, displayed when the motor is in sleep mode
PF	You are in Pan Following mode
L	You are in Locking mode
POV	You are in Point of View mode
V	You are in Vortex mode
F	You are in Following mode
GO	You are in Go mode
AV	Current aperture
TV	Current shutter speed
ISO	Current ISO
	Current EV

## Menu options description

Motor Torque	Automatic parameter tuning		
	Custom	Tilt axis	
		Roll axis	
		Pan axis	
	Level	Low torque	
		Medium torque	
High torque			
Camera Settings	Close (Close port)		
	Canon camera		
	Sony camera	Power supply off	
		Power supply on	
	Panasonic camera		
	Nikon camera		
	ccs (extension)		
	Fuji camera		
	Olympus		
	zcam		
	bmpcc		
sigma			
Parameter Settings	Speed	Control speed of joystick	Tilt axis
			Roll axis
			Pan axis
		Follow speed of motor	Tilt axis
			Roll axis
			Pan axis
	Smoothness	Tilt axis	
		Roll axis	
		Pan axis	
	Deadband	Tilt axis	
		Roll axis	
		Pan axis	
Restore default settings	Confirm		
	Cancel		
TransMount Follow Focus Motor Settings	lite/focus	Sensitivity	Low
			Medium
			High
		AB point	Set point A
			Set point B
			Clear AB point
		Reverse (control in reverse direction)	Disable
			Enable
Firmware Upgrade		Start upgrade	
	Force upgrade		

TransMount Follow Focus Motor Settings	max/zoom	Sensitivity	Low
			Medium
			High
		AB point	Set point A
			Set point B
			Clear AB point
		Reverse (control in reverse direction)	Disable
Enable			
Firmware Upgrade	Start upgrade		
	Force upgrade		
Wheel Settings	Wheel Functions	lite/focus	
		max/zoom	
		Electronic follow focus	
		Disable wheel	
	Priority	Handle control	
		External control	
	Reverse (control the wheel in reverse direction)	Disable	
Enable			
Button settings	Trigger button	Hold to trigger	
		Press to trigger	
		Press or press and hold	
Joystick settings	Reverse (control the joystick in reverse direction)	Vertical direction	Disable
			Enable
		Horizontal direction	Disable
			Enable
Calibration settings	Enter		
	Exit		
Angle (fine-tuning on motor angle)	Tilt axis		
	Roll axis		
language	Simplified Chinese		
	English		
About	Product name, firmware version number, Bluetooth name		

## Motor Torque Adjustment

When using the CRANE 2S, you have to adjust the appropriate motor velocity parameters according to the weight of your camera and lens, so that the CRANE 2S can be used in its ideal state. We recommend using automatic tuning first. The definitions and operation methods of the three motor torque methods are as follows:

**Auto torque adjustment:** Automatically adjusts the power of the motor according to the weight of the camera and lens.

**Operation method:** Press the menu button, turn the dial to "Motor Torque", and press the right button once to select it. Turn the dial again to select "auto", and press the right button once to confirm. The gimbal will now enter auto torque adjustment. Do not interfere with the gimbal. After the gimbal vibrates for a short while, the display panel will show the "√" icon, indicating that the auto torque adjustment is complete.

**Custom:** The power determines the torque of the motor, and needs to be adjusted according to the load on the gimbal. The power should be proportional to the weight of the load. A high power value will cause the gimbal itself to vibrate, while a value that is too low will affect the stability of the gimbal.

**Operation method:** Press the menu button, turn the dial to "Motor", and press the right button once to select it. Turn the dial again to "custom" and press the right button to select it. Then, press the right button again to select the corresponding axis and rotate the dial to set the corresponding parameter. After setting the parameter, press the left button to exit. The gimbal will then save the parameter and display the "√" icon on the display panel to indicate that the the auto parameter adjustment is complete.

**Level:** Three motor torque levels from low to high are provided based on the combined weight of mainstream camera lenses available on the market. Users can select the corresponding motor torque level according to the weight of their camera and lens.

**Operation method:** Press the menu button, turn the dial to "motor", and press the right button once to select it. Turn the dial again to select the strength "level", and press the right button once to enter the strength level menu. Select the corresponding strength level and press the right button to confirm. When the display screen shows the "√" icon, it means the level selection is complete.

- ① When adjusting the motor power parameters, make sure that the lock switches of the three axes on the gimbal are turned on, and the gimbal is upright and placed on level ground.
- ② If a load is changed, please readjust the balance and adjust the power parameters using the method mentioned above.
- ③ It is recommended to use auto torque adjustment first. If auto-tuning fails to meet your requirements, you can use custom settings to fine-tune the motor parameters. If the above two methods still do not meet your requirements, use the level adjustment to select the power parameters.

## Operation Modes

-  The red circle indicates that the motor will rotate along with the grip movement. The gray circle means the motor is locked and cannot move along with the grip movement.

### Pan Following mode (PF): Press the M button

The tilt axis and roll axis motors are locked, and the camera rotates with the handle while panning horizontally. Push the joystick up/down to control the tilt axis angle, and push it left/right to control the pan axis of the camera.

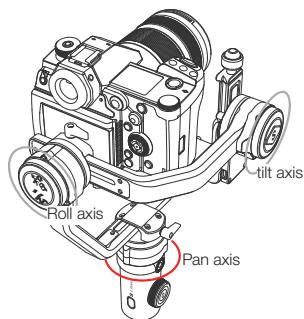

### Locking mode (L): press the M button

All three motor angles are locked, and the camera orientation will not move with the rotation of the handle. Push the joystick up/down to change the tilt angle of the camera and left/right to change the horizontal orientation of the camera.

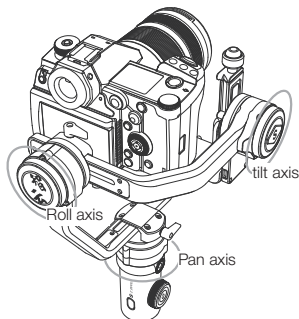

**Point of View mode (POV):** Press the M button twice  
All three motors move when the handle is rotated.

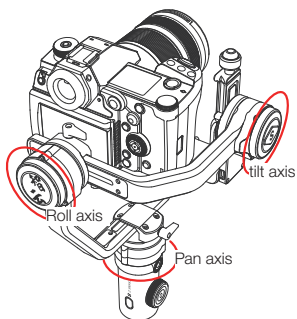

**Vortex mode (V):** Press the M button twice  
The tilt axis motor rotates upward by 90 ° , and the tilt axis, roll axis and pan axis motors follow the rotation of the handle. Push the joystick to the left/right to control the rotation of the pan axis.

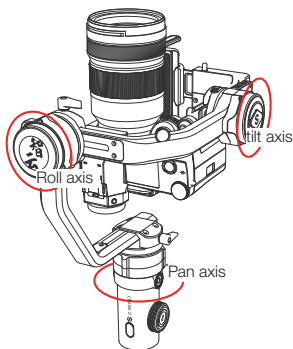

**Go mode (GO):** Press the M button thrice

The roll axis motor is locked, and the tilt axis and pan axis motors quickly follow the rotation of the handle.

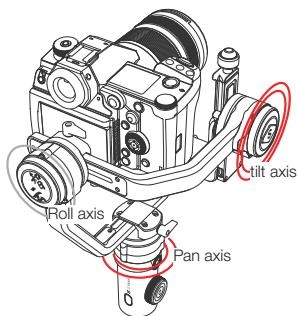

**Following mode (F):** Press or press and hold the trigger button

The roll axis motor is locked, and the tilt axis and pan axis motors follow the rotation of the handle. Push the joystick up/down to change the roll angle.

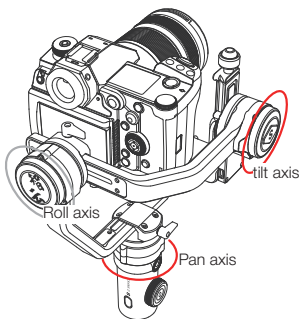

**Portrait Mode:** Mount the camera on the tilt arm for Portrait Mode; refer to the Landscape Mode for the leveling sequence steps in Portrait Mode.

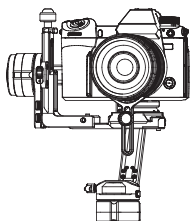

Landscape Mode

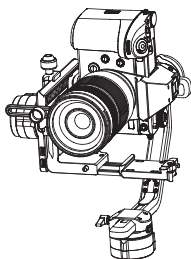

Portrait Mode

**Inverted mode:** Rotate the handle 180 degrees for inverted mode.

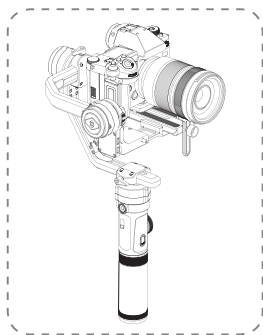

Upright mode

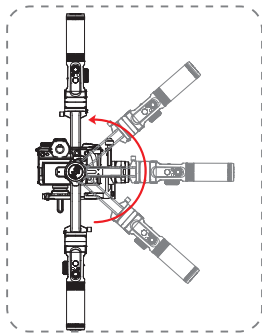

Inverted mode

 If the handle cannot be rotated directly, you can mount it upside down and level it before turning the device on.

## Manual Repositioning

In Pan Following mode (PF) and Locking mode (L), the camera can be rotated by a certain angle by hand, and the camera angle will be fixed at that angle after you release the camera. The angle of the tilt axis can be manually adjusted in Pan Following mode (PF), and the angles of the tilt axis and pan axis can be manually adjusted in Locking mode (L).

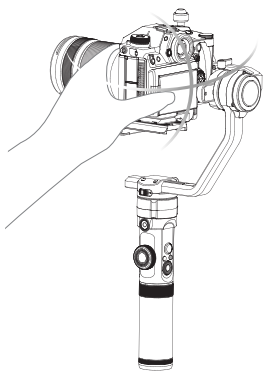

## App Download



Search for the “ZY Play” app in the app store or use your mobile device to scan the QR code on the left to download and install the app (Android 5.0 or higher; iOS 9.0 or higher).

- ⚠️ ① Users can make better use of the various functions of the CRANE 2S with the dedicated “ZY Play” app.
- ② ZY Cami is subject to updates without notice. Please always refer to the latest version.

## Connect and activate

1. Power on the CRANE 2S and turn on Bluetooth on your smartphone.
2. Open the “ZY Play” app and select the product page corresponding to CRANE 2S. Tap “Connect now”, and select the CRANE 2S with the corresponding Bluetooth name. The CRANE 2S Bluetooth name is shown on the tilt arm (USER ID: XXXX).
3. Activation on the “ZY Play” app is required if the CRANE 2S is being used for the first time, otherwise the motor will not work. Activating the CRANE 2S requires registration or login with a ZHIYUN account, and a network connection.
4. After the device is successfully activated, press and hold the M button and the motor will start working again.

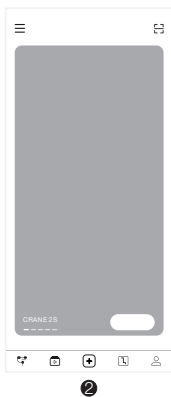
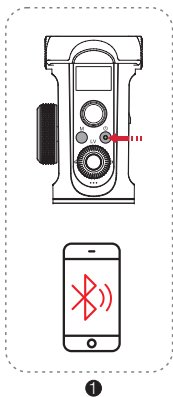

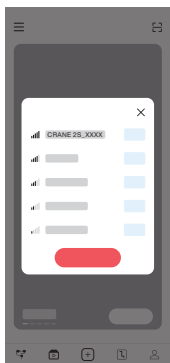

③

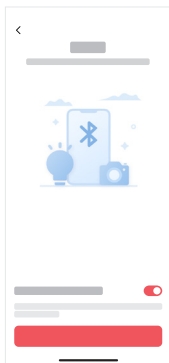

④

### Main App Features



### When is Calibration Required

Calibrate the CRANE 2S as needed.

When to calibrate	How to calibrate
<ol style="list-style-type: none"> <li>1. Slight deviation is found in the tilt angle of the camera in level position after turning on.</li> <li>2. Slight deviation is found in the roll angle of the camera in level position after turning on.</li> <li>3. Frequent small angle correction is found when the camera is in level position while the stabilizer stays still.</li> </ol>	Initialization
<ol style="list-style-type: none"> <li>1. Slight deviation is found in the level position after the initialization of the stabilizer.</li> <li>2. The stabilizer has not been used for a long time.</li> <li>3. The stabilizer undergoes significant temperature difference in operation environments.</li> </ol>	Six-sided calibration
Slight deviation is found in the tilt or roll angle of the camera in level position after initialization and six-side calibration of the stabilizer.	Fine angle adjustment

### How to initialize

After starting the CRANE 2S and entering standby mode, place the CRANE 2S on a flat surface and keep the CRANE 2S still for about 30 seconds. The CRANE 2S will automatically initialize.

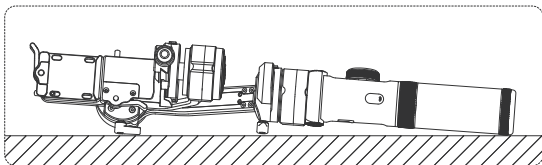

## How to perform six-side calibration

### 1. Six-side calibration via APP:

According to the method introduced in "APP Operations", please connect the stabilizer with APP, and enter "Calibration", then conduct the six-side calibration according to the prompt.

### 2. Six-side calibration via "Zhiyun Gimbal Tools"

Power on the stabilizer and turn it to standby mode. Connect the Type-C port on the stabilizer with a computer via a Type-C USB cable. Launch Zhiyun Gimbal Tools, click "open" on the top and click "calibration" on the bottom. Please conduct the process according to the following steps. A "√" mark will appear after the calibration is completed.

### 3. Six-side calibration via OLED display guide

Power on the stabilizer and enter standby mode, then press menu and rotate the dial to "calibration" option. Single press Right to confirm the selection, and single press "yes" to start. Conduct the steps appearing on the stabilizer display screen. After the calibration is completed, a "√" mark will appear on the display screen.

- ① Refer to the figure below for the steps to complete six-side calibration.  
After completing the calibration, restart the CRANE 2S and it can be used normally.
- ② The six-side calibration operation can be understood simply as making the six planes of the quick release plate perpendicular to the horizontal plane.
- ③ Six-side calibration can be performed without mounting a camera.

STEP 1

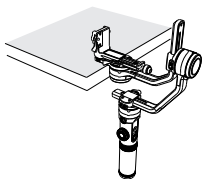

STEP 2

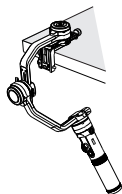

STEP 3

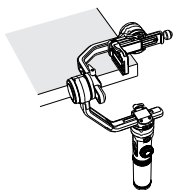

STEP 4

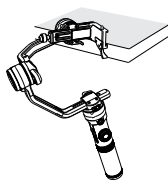

STEP 5

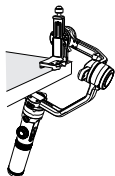

STEP 6

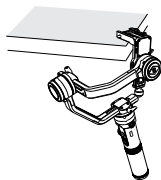

## Motor Fine-tuning

Start the CRANE 2S, click the menu button, rotate the dial to "angle", and press the right button to select it. Then, rotate the dial again to the axis you wish to adjust, and press the right button to select it. Rotate the wheel to adjust to an appropriate value. Finally, press the left button to exit and save the changes. When the display panel shows the "√" icon, it means that the fine angle adjustment has been completed.

## CRANE 2S firmware upgrade

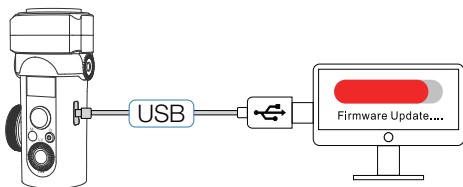

Method 1: Connect the Type-C port on the stabilizer with a computer via a Type-C USB cable to conduct the stabilizer firmware update and online calibration.

1. Open ZHIYUN official website [www.zhiyun-tech.com](http://www.zhiyun-tech.com). Click "Download"- "Firmware" on the homepage. Find and download the USB driver and the latest firmware for your stabilizer model. (For Mac and WIN10, you don't need to download USB driver.)
2. Install the downloaded driver.
3. Power on the stabilizer and enter standby mode.
4. Open "Zhiyun Gimbal Tools". Click [Open] > [Firmware Upgrade] > [Browse]. Choose [firmware.ptz]. Click "Upgrade" and wait until the firmware update is complete.

Method 2: Update via APP. According to the method introduced in "APP Operations", connect the stabilizer to APP. If a firmware update prompt pops up on APP, please tap to update.

- ① When upgrading using method one, wait for the "√" icon on the display panel before unplugging the USB Type-C data cable.
- ② Before upgrading the firmware, please ensure that the CRANE 2S has more than 50% power remaining. You will not be able to exit the app interface or access the back-end during the upgrade process. Pay attention to the prompts on the app.

Product model: CR113

Specifications				
Item	Minimum	Standard	Maximum	Notes
Operating voltage	9.8V	11.1V	12.6V	
Operating current	160mA	-	6000mA	
Power output voltage	-	5V	-	
Power output current	-	1A	-	Camera control interface
Tilt mechanical range	-91°	-	+155°	
Roll Mechanical Range	-57.5°	-	+237.5°	
Pan Mechanical Range	-	360°	-	Infinite rotation
Tilt axis controllable angle	-80°	-	+135°	
Roll axis controllable angle	-35°	-	+35°	
Pan axis controllable angle	-180°	-	+180°	
Working temperature	-10°C	25°C	45°C	
Battery Capacity	-	2600mAh	-	3 18650 lithium batteries
Operation Time	-	12h	-	Lab Data 1
Charging Time	-	4h	-	Lab Data 2
Product Net Weight	-	1880g	-	Excluding tripod and batteries
Bluetooth	Bluetooth 5.0			
Effective Isotropic Radiated Power (EIRP)	<10dBm			
Operation Frequency	2.4GHz			
Camera charging	Supports 5V 1A camera charging			
Bearing Range of 1/4" Screw Thread with Crown Gear	Load ≤ 1000g, moment arm ≤ 100mm Simultaneously			

Laboratory data 1: The battery life was tested to be 12h in an environment with ambient temperature of 25° C; CRANE 2S + fully charged 18650-2600mAh 3.7v 9.62Wh batteries; Canon EOS R+28-70mm F2 mounted and leveled with static placement.

Laboratory data 2: The charging time was tested to be 4h in an environment with ambient temperature of 25° C and using a 5V/2.4A power adapter. The charging time varies according to different environments, and actual results may be different. In addition, the lower the temperature of the charging environment, the smaller the charging current, and the longer the charging time.

All the data in this guide was gathered from internal experiments from ZHIYUN's laboratories. The data may differ to some extent under different scenarios so please refer to the actual use of the CRANE 2S.

Thank you for purchasing the CRANE 2S. The information contained herein relates to your safety and your legal rights and responsibilities. Read this entire document carefully to ensure proper configuration before use. Failure to read and follow the instructions and warnings herein may result in serious injury to you or bystanders, or damage to the CRANE 2S or other property. ZHIYUN reserves the right of final interpretation of this document and all relevant documents relating to the SCRANE 2S, and the right to make changes at any time without notice. This document is subject to update without notice. Please visit [www.zhiyun-tech.com](http://www.zhiyun-tech.com) for the latest product information.

By using this product, you hereby signify that you have read this document carefully and that you understand and agree to abide by the terms and conditions herein. You agree that you are solely responsible for your own conduct while using this product, and for any consequences thereof. You agree to use this product only for purposes that are proper and in accordance with all terms, precautions, practices, policies and guidelines ZHIYUN has made and may make available.

Except for what is mandated by the laws and regulations of the People's Republic of China, ZHIYUN accepts no liability for damage, injury or any legal responsibility incurred directly or indirectly from the use of this product. Users shall observe safe and lawful practices including, but not limited to, those set forth herein.

ZHIYUN™, TransMount™ are the trademark of Guilin Zhishen Information Technology Co., Ltd. (hereinafter referred to as "ZHIYUN" or "ZHIYUN TECH") and its affiliates. All product names or marks referred to herein are trademarks or registered trademarks of their respective holders.

### Reading Tips

Symbol Descriptions:  Operation and Use Tips  Important Notes

### Warnings

The CRANE 2S is a high-precision device. Users should be equipped with basic hands-on skills and common safety knowledge, and the device should be used with care. Read the entire CRANE 2S user guide to become familiar with the features of this product before operating it. Failure to operate the product correctly can result in damage to the product or personal property, or cause serious injury. This product is not intended for use by children. Do not use the CRANE 2S with components that are not provided or recommended by ZHIYUN or in any way that does not follow the safety guidelines in the product documentation provided by ZHIYUN. The safety guidelines herein contain instructions for safety, operation and maintenance. It is essential to read and follow all of the instructions and warnings in the user guide prior to assembly, setup or use of the CRANE 2S in order to operate the product correctly and avoid damage or serious injury.

## Safe Operation Guidelines

### Note:

1. The CRANE 2S is a high-precision control device. Damage may be caused to the CRANE 2S if it is dropped or subject to external force, and this may result in the device malfunctioning.
2. Make sure the rotation of the gimbal axes are not blocked by external force when CRANE 2S is turned on.
3. The CRANE 2S is not waterproof. Do not let the CRANE 2S come into contact with any kind of liquid, including cleaning liquids. It is recommended to use a dry soft cloth to clean the CRANE 2S.
4. Protect the CRANE 2S from dust and sand during use.

### WARNING

To avoid fire, serious injury, and property damage, observe the following safety guidelines when using, charging, or storing your batteries.

### Battery Use

1. Prevent the batteries to come into contact with any kind of liquid. Do not leave batteries out in the rain or near a source of moisture. Do not drop the battery into water. If the inside of the battery comes into contact with water, chemical decomposition may occur, potentially resulting in the battery catching on fire, and may even lead to an explosion.
2. If the battery falls into water with the stabilizer during use, take it out immediately and put it in a safe and open area. Maintain a safe distance from the battery until it is completely dry. Never use the battery again, and dispose of the battery properly as described in the Battery Disposal section below.
3. If the battery catches fire, use water, water spray, sand, fire blanket, dry powder, or carbon dioxide fire extinguisher immediately to put out the fire. Battery-caused fire may lead to explosion. Please extinct the fire by applying the methods recommended above according to the actual situation.
4. Never use non-ZHIYUN batteries. If replacement or backup is needed, please purchase new batteries from ZHIYUN's official website or authorized channels. ZHIYUN takes no responsibility for any damage caused by non-ZHIYUN batteries.
5. Never use or charge swollen, leaky, or damaged batteries. Never use or charge if the battery smells, or overheats (exceeding maximum temperature of 160 ° F/71 ° C). If your batteries are abnormal, contact ZHIYUN or a ZHIYUN authorized dealer for further assistance.
6. The battery should be used within the temperature range from -10° C to 60° C. Use of battery in environments above 60° C may lead to a fire or explosion. Use of battery below -10° C may lead to serious battery damage.
7. Do not use the battery in strong electrostatic or electromagnetic environments. Otherwise, the battery protection board may malfunction.

8. Do not disassemble or use any sharp object to puncture the battery in any way. Otherwise, the battery may leak, catch fire or explode.
9. Do not mechanically strike, crush, or throw the battery. Do not place heavy objects on the battery or charger.
10. Electrolytes inside the battery are highly corrosive. In case of accidental contact of any electrolytes with your skin or eyes, rinse immediately with water for at least 15 minutes and seek medical advice as soon as possible.
11. Do not use the battery if it has been involved in a crash or heavy impact.
12. Do not heat the battery and never put the battery in a microwave oven or in a pressurized container.
13. Do not place the battery on a conductive surface (such as a metal desk surface, eye-glasses, watch, jewelry, etc.)
14. Prevent use of wires or other metal objects that could cause positive and negative short-circuit to the battery.
15. If the battery terminal is dirty, wipe it with a clean, dry cloth. Otherwise it will cause a bad battery connection, which may result in energy loss or charging failure.

### **Battery Charging**

1. The battery will automatically stop charging once it is full. Please disconnect the battery and the charger when fully charged.
2. Do not attach the batteries to a wall outlet or car charger socket directly. Always use a ZHIYUN approved adapter for charging. ZHIYUN takes no responsibility if the battery is charged using a non-ZHIYUN charger.
3. Do not put the battery and charger near flammable materials or on flammable surfaces (such as carpet or wood). Never leave the battery unattended during charging to prevent any accident.
4. Do not charge the battery immediately after use, because the battery temperature may be too high. Do not charge the battery until it cools down to normal room temperature. Charging the battery with its temperature over 45° C or lower than 0° C may lead to leakage, overheating, or damage.
5. Examine the charger before use, make sure there is no damage to the enclosure, cord, plug, or other parts. Never use a damaged charger. Do not clean the charger with any liquid containing alcohol or other flammable solvents. Disconnect the charger when not in use.

### **Battery Storage**

1. Keep batteries out of the reach of children and pets.
2. Do not leave the battery near heat sources such as a furnace or heater, or inside of a vehicle on hot days. Never expose the battery in any environment with temperature of over 60° C. The ideal storage temperature is 22° C-28° C.
3. Store batteries in a dry environment.
4. Do not leave the battery unused for too long after it has been completely discharged to prevent over-discharge of battery which may result in battery damage and permanent failure.

### **Battery Maintenance**

1. Do not over-charge or over-discharge the battery, which will damage the battery;
2. The battery performance will be affected for not being used for a long time;
3. Never use the battery when the temperature is too high or too low;
4. Do not store the battery in any environment with a temperature of over 60°C .

### **Battery Disposal**

1. Please fully discharge the battery before putting it in the designated recycling bin. Batteries contain hazardous constituents and it is forbidden to put the battery in general waste bin. For related details please abide by the local laws and regulations on battery recycling and disposal.
2. If the battery cannot be fully discharged, never put it in battery recycling bin. Please contact battery recycling companies for a proper solution.

### Warranty Period

1. Customers are entitled to replacement or free repair service in case of quality defect(s) found in the product within 15 days upon receipt of the product.
2. Customers are entitled to free repair service from ZHIYUN for any product proven defective in material or workmanship that results in product failure during normal consumer usage and conditions within the valid warranty period, which is 12 months counting from the date of selling. However, warranty period varies by product component and country of purchase. Please contact our after-sales service team on ZHIYUN official website or your place of purchase for detailed warranty information.

### Warranty Exclusions

1. Products subjected to unauthorized repair, misuse, collision, neglect, mishandling, soaking, accident, and unauthorized alteration.
2. Products subjected to improper use or whose labels or security tags have been torn off or altered.
3. Products whose warranty has expired.
4. Products damaged due to force majeure, such as fire, flood, lightning, etc.

### Warranty Claim Procedure

1. If failure or any problem occurs to your product after purchase, please contact a local agent for assistant, or you can always contact ZHIYUN's customer service through email at [service@zhiyun-tech.com](mailto:service@zhiyun-tech.com) or website at [www.zhiyun-tech.com](http://www.zhiyun-tech.com).
2. Your local agent or ZHIYUN's customer service will guide you through the whole service procedure regarding any product issue or problem you have encountered. ZHIYUN reserves the right to reexamine damaged or returned products.

#### Customer information

Customer Name : Contact No :

Address :

#### Sales Information

Sales Date : Prod. Serial No :

Dealer :

Contact No ::

#### #1 Maintenance Record

Service Date : Signature of Repairman :

Cause of Problem :

Service Result :  Solved  Unsolved  Refunded (Replaced)



Website



Weibo



Vimeo



Google+



Facebook  
(Zhiyun Support)



Facebook  
(Zhiyun Tech)



Youku



Youtube



Wechat



Instagram

Tel: +86 400 900 6868

USA Hotline: +1 808-319-6137,9:00-18:00 GMT-7,Mon-Fri

Europe Hotline: +49 (0) 61018132180,10:00-17:00 GMT+1,Mon-Fri

Web: [www.zhiyun-tech.com](http://www.zhiyun-tech.com)

E-mail: [service@zhiyun-tech.com](mailto:service@zhiyun-tech.com)

Address: 09 Huangtong Road, Tieshan Industrial Zone, Qixing District, Guilin, 541004, Guangxi, China.

## Certificate of Quality

This product is confirmed to meet quality standards and permitted for sale after strict inspection.

QC Inspector: \_\_\_\_\_



Please download the latest version from [www.zhiyun-tech.com](http://www.zhiyun-tech.com)

This document is subject to change without notice.

ZHIYUN™ is a trademark of ZHISHEN.

All other trademarks cited herein are the property of their respective owners.

Copyright © 2020 ZHISHEN. All rights reserved.

ZHIYUN-TECH.COM