

Perfecting the moment

zhiyun-tech.com



CRANE 2













User Guide

V1.01

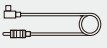
Contents

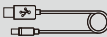
■ Packing List.....	1
■ Disclaimer and Warning.....	2
■ Get to Know CRANE 2	7
■ Preparing and Charging the Batteries	8
■ Installation.....	10
■ Balance Adjustment	13
■ How to Use	16
■ APP Operations.....	23
■ Calibration and Firmware Upgrade.....	25
■ Usage of Main Accessories	29
■ Product Specifications.....	33
■ Warranty Terms.....	34
■ Contact Card	36

The product package comes with the following items. In case that any item is found missing, please contact ZHIYUN or your local selling agent.

	Crane 2 Three-axis Gimbal Stabilizer	1		Tripod	1
	18650 Li-ion Battery	3		Battery Charger	1
	Canon Camera Control Cable ZW-Mini-002	1		Canon Camera Control Cable ZW-Micro-002	1
	Panasonic Camera Control Cable ZW-CTIA-002	1		Sony Camera Control Cable ZW-MULTI-002	1
	Micro USB Cable	1		Storage Case	1
	Shoulder Strap	1		User Guide	1

Thank you for using ZHIYUN CRANE 2. The information contains herein affects your safety and your legal rights and responsibilities. Read this entire document carefully to ensure proper configuration before use. Failure to read and follow the instructions and warnings herein may result in serious injury to you or bystanders, or damage to your device or property.

ZHIYUN reserves the right of final explanation for this document and all relevant documents relating to CRANE 2, and the right to make changes at any time without notice. Please visit www.ZHIYUN-TECH.com for the latest product information.

By using this product, you hereby signify that you have read this document carefully and that you understand and agree to abide by the terms and conditions herein. You agree that you are solely responsible for your own conduct while using this product, and for any consequences thereof. You agree to use this product only for purposes that are proper and in accordance with all terms, precautions, practices, policies and guidelines ZHIYUN has made and may make available.

ZHIYUN™ accepts no liability for damage, injury or any legal responsibility incurred directly or indirectly from the use of this product. Users shall observe safe and lawful practices including, but not limited to, those set forth herein.

ZHIYUN™ is the trademark of Guilin Zhishen Information Technology Co., Ltd. (hereinafter referred to as "ZHIYUN" or "ZHIYUN TECH") and its affiliates. All product names or marks referred to hereunder are trademarks or registered trademarks of their respective holders.

Glossary

The following terms are used throughout the product literature to indicate various levels of potential harm when operating this product.

WARNING: Procedures, which if not properly followed, may incur property damage, grave accident, or serious injury.

CAUTION: Procedures, which if not properly followed, may incur property damage and serious injury.

NOTICE: Procedures, which if not properly followed, may incur property damage or minor injury.

Warning

Read the ENTIRE User Guide to become familiar with the features of this product before operating. Failure to operate the product correctly can result in damage to the product or personal property and cause serious injury. This is a sophisticated product. It must be operated with caution and common sense and requires some basic mechanical ability. Failure to operate this product in a safe and responsible manner could result in injury or damage to the product or other property. This product is not intended for use by children without direct adult supervision. DO NOT use with incompatible components or in any way otherwise as mentioned or instructed in the product documents provided by ZHIYUN. The safety guidelines herein contain instructions for safety, operation and maintenance. It is essential to read and follow all of the instructions and warnings in the User Guide, prior to assembly, setup or use, in order to operate the product correctly and avoid damage or serious injury.

Safe Operation Guidelines

■ CAUTION:

1. CRANE 2 is a high-precision control device. Damage may be caused to CRANE 2 if it is dropped or subject to external force, and this may result in malfunction.
2. Make sure the rotation of the gimbal axes is not blocked by external force when CRANE 2 is turned on.
3. CRANE 2 is not waterproof. Prevent contacts of any kind of liquid or cleaner with CRANE 2. It is recommended to use dry cloth for cleaning.
4. Protect CRANE 2 from dust and sand during use.

■ WARNING

To avoid fire, serious injury, and property damage, observe the following safety guidelines when using, charging, or storing your batteries.

Battery Safety Guidelines

1. Prevent the batteries to come into contact with any kind of liquid. Do not leave batteries out in the rain or near a source of moisture. Do not drop the battery into water. If the inside of the battery comes into contact with water, chemical decomposition may occur, potentially resulting in the battery catching on fire, and may even lead to an explosion.
2. If the battery falls into water with the stabilizer during use, take it out immediately and put it in a safe and open area. Maintain a safe distance from the battery until it is completely dry. Never use the battery again, and dispose of the battery properly as described in the Battery Disposal section below.
3. If the battery catches fire, use water, water spray, sand, fire blanket, dry powder, or carbon dioxide fire extinguisher immediately to put out the fire. Please extinct the fire by applying the methods recommended above according to the actual situation.
4. Never use non-ZHIYUN batteries. If replacement or backup is needed, please purchase new batteries from ZHIYUN's official website or authorized channels. ZHIYUN takes no responsibility for any damage caused by non-ZHIYUN batteries.
5. Never use or charge swollen, leaky, or damaged batteries. Never use or charge if the battery smells, or overheats (exceeding maximum temperature of 160°F / 71°C). If your batteries are abnormal, contact ZHIYUN or a ZHIYUN authorized dealer for further assistance.
6. The battery should be used within the temperature range from -10° C to 50° C. Use the battery in environments above 50° C can lead to a fire or explosion. Use of battery below -10° C can lead to serious battery damage.
7. Do not use the battery in strong electrostatic or electromagnetic environments. Otherwise, the battery protection board may malfunction.
8. Do not disassemble or use any sharp object to puncture the battery in any way. Otherwise, the battery may leak, catch fire or explode.
9. Do not mechanically strike, crush, or throw the battery. Do not place heavy objects on the battery or charger.
10. Electrolytes inside the battery are highly corrosive. In case of accidental contact of any electrolytes with your skin or eyes, rinse immediately with water for at least 15 minutes and seek medical advice as soon as possible.
11. Do not use the battery if it has been involved in a crash or heavy impact.
12. Do not heat the battery and never put the battery in a microwave oven or in a pressurized container.

13. Do not place the battery cell on a conductive surface (such as a metal desk surface).
14. Prevent use of wires or other metal objects that could cause positive and negative short-circuit to the battery.
15. If the battery terminal is dirty, wipe it with a clean, dry cloth. Otherwise it will cause a bad battery connection, which may result in energy loss or charging failure.

Battery Charging

1. Do not attach the batteries to a wall outlet or car charger socket directly. Always use a ZHIYUN approved adapter for charging. ZHIYUN takes no responsibility if the battery is charged using a non-ZHIYUN charger.
2. Do not put the battery and charger near flammable materials or on flammable surfaces (such as carpet or wood). Never leave the battery unattended during charging to prevent any accident.
3. Do not charge the battery immediately after use, because the battery temperature may be too high. Do not charge the battery until it cools down to normal room temperature. Charging the battery with its temperature over 40°C or lower than 15°C may lead to leakage, overheating, or damage.
4. Examine the charger before use, make sure there is no damage to the enclosure, cord, plug, or other parts. Never use a damaged charger. Do not clean the charger with any liquid containing alcohol or other flammable solvents. Disconnect the charger when not in use.

Battery Storage

1. Keep batteries out of the reach of children and pets.
2. Do not leave the battery near heat sources such as a furnace or heater, or inside of a vehicle on hot days. Never expose the battery in any environment with temperature of over 60°C. The ideal storage temperature is 22°C-28°C.
3. Store batteries in a dry environment.
4. Do not leave the battery unused for too long after it has been completely discharged to prevent over-discharge of battery which may result in battery damage and permanent failure.

Battery Maintenance

1. Never use the battery when the temperature is too high or too low.
2. Do not store the battery in any environment with a temperature of over 60°C.

Transportation Notice

1. Discharge the battery power to 5% or lower before carrying the battery on an airline flight. Only discharge the battery in a fireproof location, ideally in a dry and open area.
2. Do not store or transport batteries together with metal objects such as eyeglasses, watch, and jewelries, etc.
3. Do not transport damaged batteries. When transporting, be sure to discharge the battery to less than 50%.

Battery Disposal

Dispose of the battery in specific recycling boxes only after a complete discharge. Do not put away the battery in regular trash containers. Strictly follow your local regulations regarding the disposal and recycling of batteries.

■ NOTICE

Battery Use

Make sure the batteries are fully charged before each time of use.

Battery Charging

The battery will stop charging automatically when it is full. Disconnect the batteries from the charger when fully charged.

Battery Storage

1. Discharge the battery to 40%-65% if it will NOT be used for over 10 days. This can greatly extend the battery life.
2. The battery enters hibernation mode when voltage gets too low. Charge the battery will bring it out of hibernation.
3. Remove batteries from the stabilizer when not in use and store them in a specialized container.

Battery Disposal

If the battery cannot be fully discharged, do not leave it in the recycling box, but contact a professional battery disposal/recycling agent for further assistance.

This document is subject to change.
ZHIYUN™ is a trademark of ZHIYUN TECH.
Copyright©2017 ZHIYUN TECH. All rights reserved.

Get to Know CRANE 2

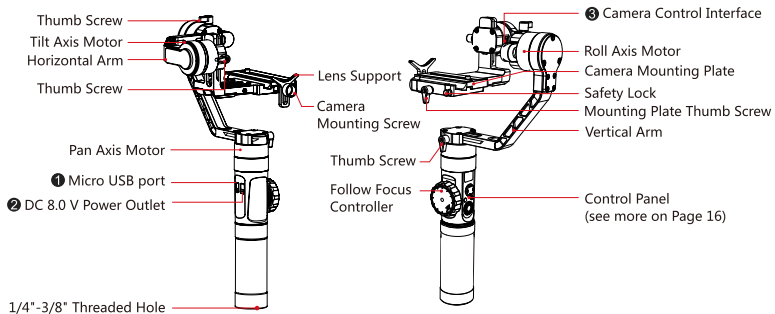

Crane 2 Interface Description

①				
②				
③				

For the first use of Crane 2, please use the dedicated charging device contained in the package to fully charge and activate the batteries to ensure the normal use of the product.

Charger & Battery Description

Charger Specifications

Name: 18650*3 Li-ion battery charger
 Model: ZC-18650-3
 Input: 5V = 2400mA
 Output: 4.2V = 800mA*3

- Shines solid RED light when charging.
- Shines BLUE light when fully charged.

Battery Specifications

Name: 18650 Li-ion battery
 Model: IMR 18650
 Capacity: 2000mAh
 Voltage: 3.7V

- Notice:
 1. Please read the disclaimer and warning herein as well as the description on the battery label carefully before using the batteries.
 2. The ZC-18650-3 charger is for charging ZHIYUN's IMR 18650 Li-ion Battery only. Do not charge batteries of other models or brands, otherwise it may lead to accident.

⚠ Please use and charge batteries provided or approved by ZHIYUN only. ZHIYUN will not take any responsibility for explosion, fire and/or accidents caused by non-ZHIYUN batteries.

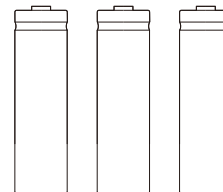
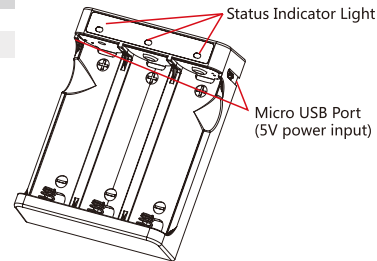

Charging Procedure

1. Insert the batteries into the charger in the right direction (positive/negative end) accordingly.
2. Connect the charger to the adapter via the Micro USB cable.
3. Plug the adapter into the power outlet to start charging.

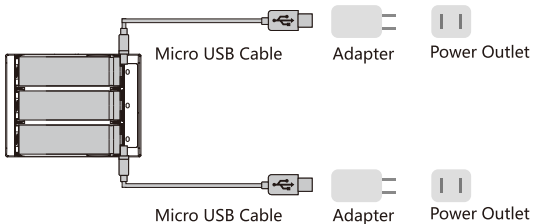

- ⚠ There is a Micro USB 5V power input port on both sides of the charger, which supports one adapter or two adapters charging simultaneously (faster).
- 2. The simultaneous charging with two adapters may fail when the power is under charged (like when the current of adapter is below 1000mA); Adapter with higher current capacity is recommended;
- 3. The USB Port along side the stabilizer does not support charging to batteries.

- ⚠ 1. Please use qualified standard 5V/≥2000mA adapter for battery charging; Charging time depends on the maximum input current of the adapter.
- 2. The stabilizer comes standard with three high-discharge-rate dedicated batteries. Please use and charge batteries provided or approved by ZHIYUN only.
- 3. Please make sure all three batteries are fully charged. Either under charged battery can lead to the failure of the stabilizer.

Battery Installation

Unscrew the battery compartment and insert the three IMR 18650 batteries in the right direction (positive/negative end), then tighten the battery compartment.

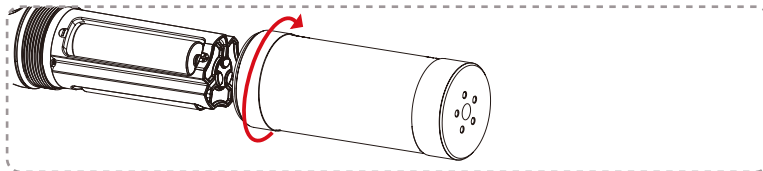

- ⚠ Please use and charge batteries provided or approved by ZHIYUN only, in case of accidents.

Tripod

Get the tripod ready and tighten it to the 1/4"-3/8" threaded hole at the bottom of the stabilizer, then unfold the tripod on a flat surface.

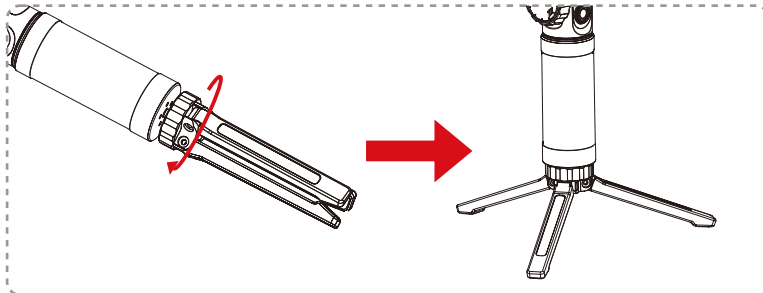

Installing Camera

1. Loosen the mounting plate thumb screw, press and hold the safety lock while sliding out the quick release plate (to the opposite direction of the arrow mark on it).

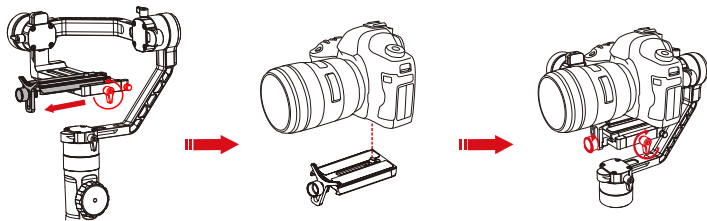

2. Install the lens to quick release plate, then tighten the 1/4" screw at its bottom (as shown above).

3. Slide in the quick release plate installed with the camera following the direction of the arrow mark on camera mounting plate, then tighten the thumb screw to finish the installation of the quick release plate.

4. Loosen the screw on lens support and adjust the support to keep the lens firm and stabilized.

⚠ Note: Do not power on stabilizer before finishing the camera installation. Please hold the camera stable during the whole process in case of any malfunctioned rotation.

Connecting Camera Control Cable

In the case of Canon camera, connect the control cable to the port on the tilt motor axis with the Micro USB end, and then the other end to the left-side port on the camera.

⚠ Please make sure the stabilizer is powered off or in standby mode when connecting the camera control cable in case of malfunctioned rotation.

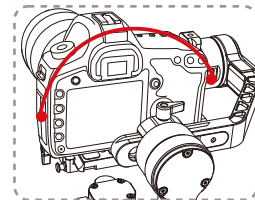

Zhiyun Camera Control Cable Function Table

Camera brand	Canon		Sony		Panasonic
	5D2/5D3	5D4	Sony camera with MULTI interface		GH3/GH4
Camera model	ZW-Mini-002	ZW-Micro-002	ZW-MULTI-001	ZW-MULTI-002	ZW-CTIA-002
Camera control cable interface	Micro USB to Mini USB	Micro USB to Micro USB	Micro USB to MULTI USB		Micro USB to CTIA
Photo	√	√	√	√	√
Video	√	√	√	√	√
Real-time preview	√	√	×	×	×
AV	√	√	×	×	×
TV	√	√	×	×	×
ISO	√	√	×	×	×
EV	√	√	×	×	×
Zoom	×	×	√	√	×
Focus	√	√	×	×	×
Camera charging	×	×	×	√	×
Standard camera control cable	√	√	×	√	√

⚠ Please make sure the camera is properly mounted and balanced, otherwise the stabilizer may fail to start or operate normally.

Level Adjustment on Tilt Axis

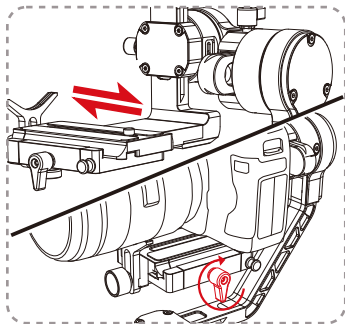

Loosen the thumb screw on the quick release plate so that it can slide forward or backward.

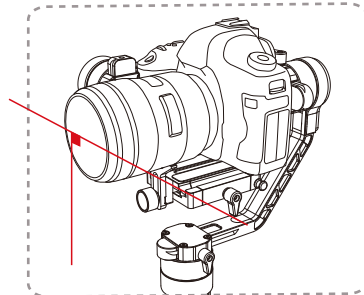

Hold the horizontal arm on the tilt axis with one hand and adjust the position of the camera to find a level balance where the camera can stay still and almost level with its lens facing front, complete this step by tightening up the camera mounting thumb screw.

⚠ The balance status of the stabilizer will greatly affect the run time.

Balance Adjustment on Tilt Axis

Loosen the thumb screw (rotate about 3 times); Adjust the tilt axis until the camera can stay still with the lens facing up (i.e. the camera stays still and vertical to the ground), complete this step by tightening up thumb screw.

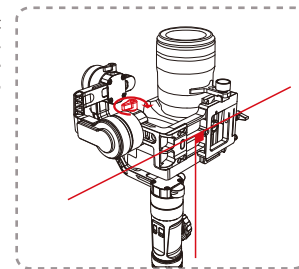

Balance Adjustment on Roll Axis

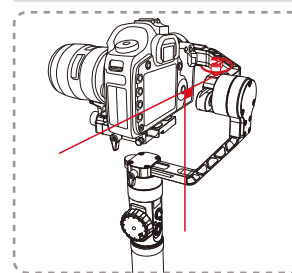

Loosen the thumb screw (rotate about 3 times); Adjust the tilt axis until the camera can stay still with the lens facing up (i.e. the camera stays still and vertical to the ground), complete this step by tightening up thumb screw.

Balance Adjustment on Pan Axis

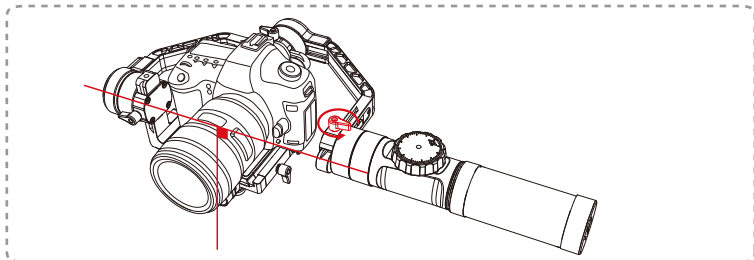

Loosen the thumb screw on the pan axis. Adjust the pan axis until the camera can stay still while keeping the vertical arm level when turned to the right/left side. Complete balance adjustment by tightening up all thumb screws.

💡 If the camera installed is too light that it's impossible to achieve balanced adjustment, please purchase the dedicated counterweight (100g) provided by ZHIYUN and install it under the camera mounting plate to finish balance installation.

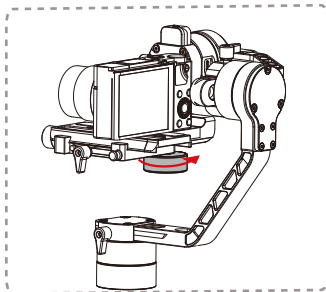

Control Panel Description

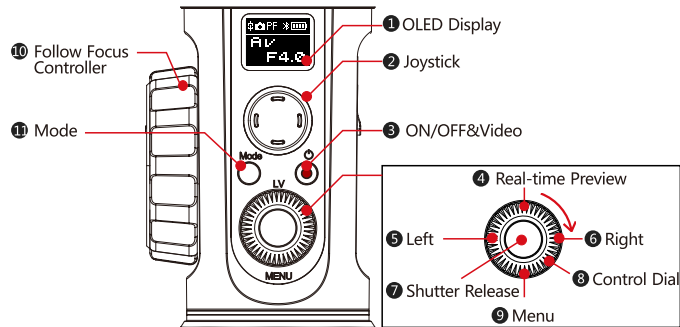

- ① **OLED Display**
Stabilizer status and camera parameters display (see more on page 18).
- ② **Joystick**
Four-way direction control of the camera/lens.
- ③ **ON/OFF&Video***
 - Long press for 3 seconds to power on/off.
 - Single press to start/end video recording.
- ④ **Real-time Preview***
Single press the button to enter the real-time preview mode.
- ⑤ **Left***
 - In main screen, single press to return to previous option.
 - In menu screen, single press to return to previous screen.
- ⑥ **Right***
 - In main screen, single press to move to next option.
 - In menu screen, single press to confirm selection.
- ⑦ **Shutter Release***
 - Halfway press the button to activate auto focus.
 - Full press the button to take single shots.
- ⑧ **Dial***
 - In main screen, rotate the dial to adjust camera parameters.
 - In menu screen, rotate the dial to switch between options.

9 Menu

Single press to enter or exit the menu.

10 Follow Focus Controller*

Rotate the controller to adjust the focal length in real time and realize follow focus control.

11 Mode

- Press for 1 second to enter or exit standby mode.
- Single press to switch between pan-following and lock mode.
- Quick double press to enter the following mode.
- Quick triple press to enter the selfie mode (180° rotation on pan axis)

* marked functions are only available for Canon cameras properly connected to the stabilizer. See more at Zhiyun Camera Control Cable Function Table on page 12.

ZHIYUN - Panasonic Camera Control Function Description

Please refer to the instruction on Camera Control Cable Configuration on page 19 to choose the right option for your camera.

1. Shutter release: Halfway press ⑦ "Shutter Release" button to realize auto focus and take single shots.
2. Video recording: Single press ③ "ON/OFF&Video" button to start or end video recording.

ZHIYUN - Sony Camera Control Function Description

Please refer to the instruction on Camera Control Cable Configuration on page 19 to choose the right option for your camera.

1. Shutter release: Fully press ⑦ "Shutter Release" button to realize auto focus and take single shots.
2. Video recording: Single press ③ "ON/OFF&Video" button to start or end video recording.
3. Zooming: Press ⑤ "Left" button or ⑥ "Right" button to control the focal length.

Note: The non-motor-driven lens does not support optical zoom (recommended motor-driven lens: E PZ 18-105mm F4 GOSS, E PZ 16-50mm F3.6-5.6 OSS).

1. For Sony and Panasonic mirrorless camera with EVF, Real-time Preview is not needed.
2. When mounting a Sony camera to the stabilizer, make sure to power on the stabilizer before the camera, otherwise the stabilizer may fail to control the camera.
3. When powering on the stabilizer, please hold the camera with one hand in case of malfunctioned rotation.
4. When powering on, avoid shaking of the stabilizer which may lead to start-up failure.

OLED Display Description

Display screen for camera params setting



Display screen for stabilizer modes (camera params setting unavailable)



Menu screen



1. Icon Description

PF	

F	
L	
AV	
TV	
ISO	

2. Menu Description

Sensi: Camera focus sensitivity control; with 3 adjustable options: low, medium and high;
 Motor: Stabilizer motor force adjustment; with 3 adjustable options: low, medium and high;
 Camera: Extension interface configuration to adapt different camera models;
 Options: Close, Sony, Panaso (Panasonic), Canon
 Calibration: Six-side calibration for stabilizer; See more on page 25.
 Angle: Fine tunes the motor angle on the tilt/roll axis; See more on page 27.
 Reverse : The sub-menu includes "Joystick" and "Wheel" (FF control), press the right side of the dial to enter either selected item, then choose "Yes" or "No" to enable or disable reverse control of the Joystick or Wheel. The default setting is set to No.
 About: Displays software version and stabilizer model information.

Crane 2 - Canon Controllability Table

Options Camera Mode	Photo	Video	AV	TV	ISO	EV
AV	√	√	√	x	√	√
TV	√	√	x	√	√	√
M	√	√	√	√	√	√
P	√	√	x	x	√	√

Note: For Canon 5D4, the EV can be adjusted by setting iso "AUTO" while the Mode Dial is set to "M". Canon cameras, under real-time preview, can realize focus control.

Motor Force Adjustment

The motor force of the stabilizer needs to be adjusted (3 levels) to adapt the stabilizer to cameras and lens of different weight for ideal use.

- | | | | |
|----------------------------|---|-------------------------|--|
| sensi
◆ motor
camera | 1. Single press Menu and rotate the dial to "motor", then press right to enter the "motor" setting. | • low
medium
high | 2. Rotate the dial to choose the appropriate motor force (3 levels), press right to confirm the option, then restart the stabilizer to finish. |
|----------------------------|---|-------------------------|--|

Motor Force	Weight Capacity	Compatible Camera & Lens Examples
Low	Light	Sony A7S Camera+SEL35F28Z Lens
Medium (default)	Medium	Canon 5D Camera+EF 50mm F/1.8 II Lens
High	Heavy	Canon 5D Camera+EF 24-70mm f/2.8 L II USM Lens

- ⚠️ Either the motor force is set too high or too low (unmatched with weight capacity) can lead to camera shake and affect normal use of the stabilizer.

Camera Control Cable Configuration

Please choose the corresponding option to configure your camera control cable.

- | | | | |
|----------------------------|---|----------------------------|---|
| sensi
motor
◆ camera | 1. Single press Menu and rotate the dial to "camera", then press right to enter the "camera" setting. | ◆ close
 canon
sony | 2. Rotate the dial to choose your camera brand, press right to confirm the option and restart the stabilizer to finish. |
|----------------------------|---|----------------------------|---|

- 💡 If there is no option to match your camera brand or there is no need to connect your camera, choose "Close".

- ⚠️ 1. You need to restart the stabilizer to finish adjustment and configuration of motor force and camera control cable.
 2. After re-setting the parameters, the stabilizer will enter standby mode, please long press mode button to activate the camera.

Control Mode Description

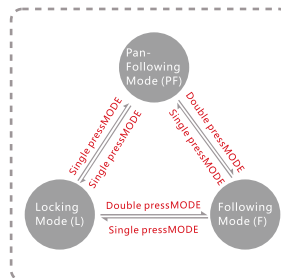

Mode switch:
 The stabilizer enters Pan Following Mode by default each time when powered on. Switch into Locking Mode by single pressing on the MODE button. Double press the MODE button to enter the Following mode. Single press the MODE button under the Following Mode will return to the previous mode. Quick press MODE three times and the camera will turn 180° along the pan axis while the active control mode remains unchanged.

See ZHIYUN's product training videos on www.zhiyun-tech.com for more operation tips.

Mode Switch

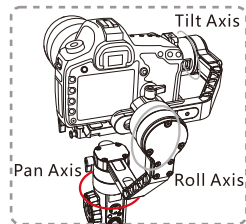

Pan Following Mode (PF): The camera pans left/right following the movement of the stabilizer while the tilt and roll axes are locked. Push the joystick left/right allows manual control of the tilt axis.

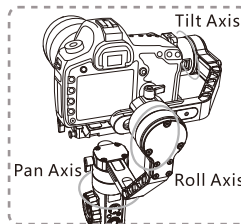

Locking Mode (L): This mode locks movement of all three axes to keep the camera fixed on a shooting direction. Push the joystick up/down and left/right allows manual control of the tilt axis and pan axis.

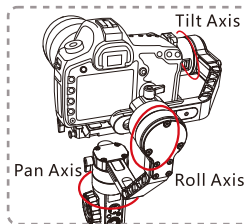

Following Mode (F): The camera pans and tilts following the movement of the stabilizer. Push the joystick left/right allows manual control of the roll axis.

Bottom up Mode Operation

Top Down Mode

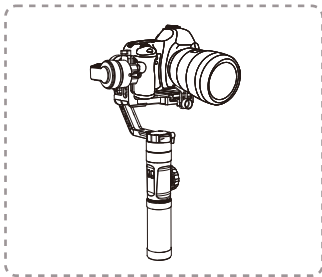

Bottom Up Mode

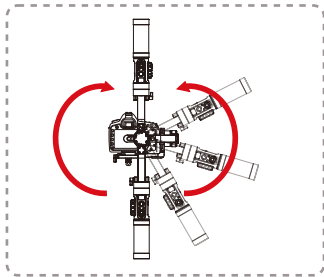

Please ensure balanced installation of the camera under top down mode and do not rotate or shake the handle while initiating the bottom up mode (as seen in graph).

⚠ Note: The size of the camera and its balance condition when mounted may affect the successful access to Bottom Up mode. For certain camera models, balance should be adjusted after access to Bottom Up mode.

DC 8.0 V Power Outlet Usage

The DC 8.0 V power outlet on the side of the stabilizer can be used for charging the Canon 5D camera through a DC connector DR-E6 (purchase separately).

Charging 5D3/5D4 camera:

Powering on:

- 1.First, connect the power input end of the connector to the DC 8.0V power outlet, then connect the other end of the connector to the camera.
- 2.Install the camera to the stabilizer and power on the stabilizer, then start up the camera.

Powering off:

First, power off the camera, then unplug the connector from the stabilizer.

Charging 5D2 camera:

Powering on:

- 1.Start up the stabilizer, long press the mode button to enter standby mode.
2. Connect the power input end of the connector to the DC 8.0V power outlet, then connect the other end of the connector to the camera.
3. Install the camera to the stabilizer and adjust gimbal balance.
4. Power on the camera and long press mode button to activate the stabilizer.

Powering off:

First, power off the camera, then unplug the connector from the stabilizer.

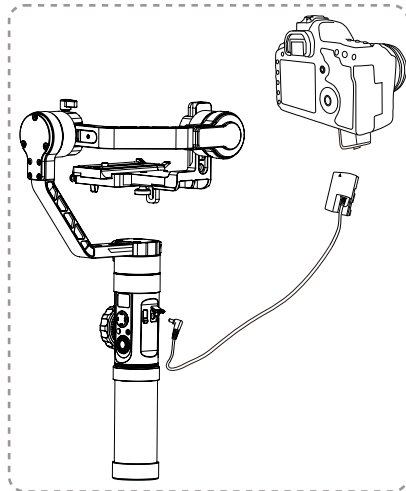

⚠ 1.Original Canon DR-E6 DC power connector is recommended; Please follow the procedure herein in case of accidents.

2.Please power on/off the camera in accordance with the procedure, otherwise the camera may fail to start.

APP Download and Installation



Download the APP from ZHIYUN's official website www.ZHIYUN-TECH.com, or by directly scanning the QR code on the left (Android 5.0 above or iOS9.0 above required) to download. iOS or Android users can download the APP by searching "ZY Play" in APP Store.

The ZHIYUN APP is subject to regular update, try out now to discover more functions.

Connecting the Stabilizer to Smartphone

- 1.Power on the stabilizer.
- 2.Tap ZHIYUN's APP icon to open.
- 3.Tap the signal icon on the top to activate Bluetooth and search for nearby signals, choose your stabilizer to connect.



Main Features of the APP

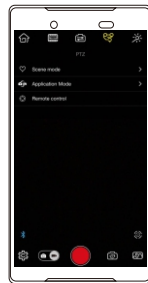

Basic Setting Screen:
Motor force setting and camera brand selection.



Control Screen:
Stabilizer control panel via Bluetooth.



Calibration Screen:
Calibration is required when deviations are found in the 3 axes and the leveling of the camera. Tap "Start Calibration", and complete the 6-side calibration procedure following onscreen illustrations.



Gimbal Setting Screen :
Allows adjustment of various parameter settings of the stabilizer (Refer to APP instructions for specific operations.)

When do you need to calibrate the stabilizer?

Please calibrate the stabilizer when necessary to ensure normal use.

When	How
a) Slight deviation is found in the tilt angle of the camera in level position after startup. b) Slight deviation is found in the roll angle of the camera in level position after startup. c) Frequent small angle correction is found when the camera is in level position while the stabilizer stays still.	Initialize the stabilizer
a) Slight deviation is still found in level position after the initialization of the stabilizer. b) Stabilizer unused for a long time. c) Too large temperature difference between operation environments.	Conduct six-side calibration
Slight deviation is still found in the tilt or roll angle of the camera in level position after the initialization and six-side calibration of the stabilizer.	Fine tune motor force

Initialization Method

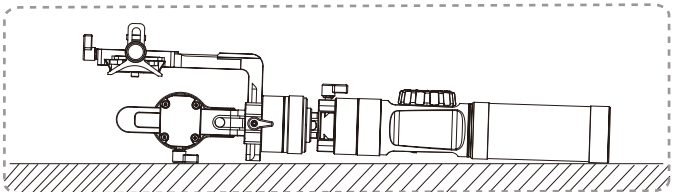

1. Correctly install the batteries.
2. Hold the camera mounting plate with one hand, long press the power button to start up the stabilizer; Long press the Mode button to enter the standby mode while holding the camera mounting plate through the whole process in case of start-up failure.

⚠ If the angle deviation still persists after the initialization, please try again following the procedure.

Six-side Calibration

Six-side calibration

1. Power on the stabilizer and enter the standby mode, press menu, rotate the dial to "calibration" option, press Right to enter the option.
2. As seen below, conduct the six-side calibration following the 6 steps shown in the graphs, finish by pressing any button to exit the menu.

STEP 1

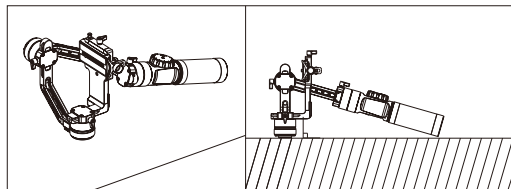

STEP 2

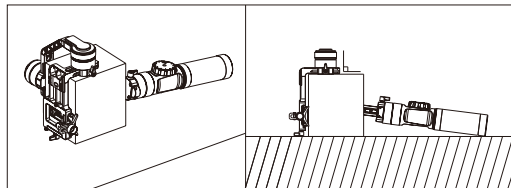

STEP 3

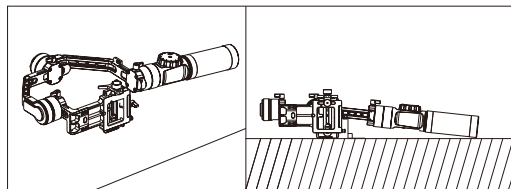

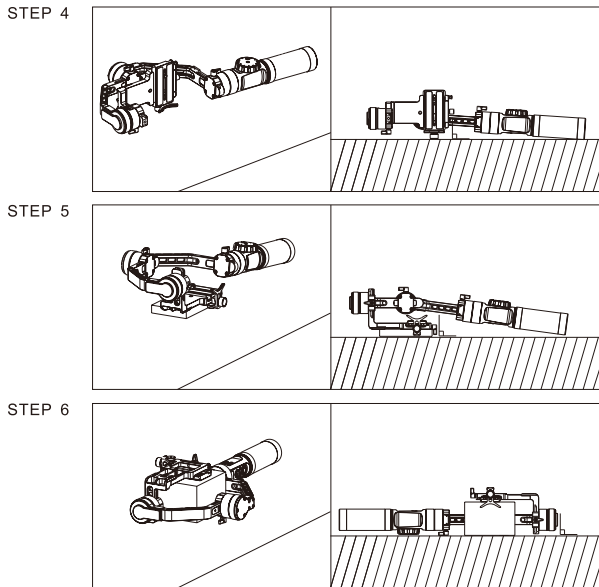

Six-side calibration through APP

Please refer to "APP Operations" for more information; Connect the stabilizer to ZHIYUN's APP - ZY Play - via Bluetooth, enter "calibration" and finish the six-side calibration following the APP instruction.

💡 Six-side calibration is to make all six sides of the camera mounting plate vertical to the level surface.

Motor Fine-tuning

Fine tune the motor through stabilizer:

Power on the stabilizer and enter standby mode, then rotate the dial and press right to enter the "angle" option; Adjust the value of the tilt and roll axis angle to your actual needs.

Fine tune the motor through APP:

Please refer to "APP Operations" for more information; Connect the stabilizer to ZHIYUN's APP - ZY Play - via Bluetooth, then enter "Gimbal Setting" screen and adjust the value of the tilt and roll axis angle to your actual needs.

Firmware Upgrade

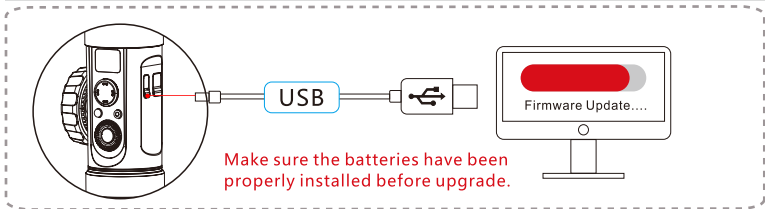

Connect the stabilizer to your computer via Micro USB cable to get ready for the firmware upgrade and calibration.

1. Visit ZHIYUN's official website: www.zhiyun-tech.com Click "DOWNLOAD" and find the Firmware Upgrade Tutorial package, then download the driver, calibration tool and latest firmware corresponding to your stabilizer. (USB driver installation is not needed for Mac and WIN 10 system).
2. Connect the stabilizer to your computer via Micro USB cable, power on the stabilizer and finish the installation of the driver.
3. Power on the stabilizer and long press mode button to enter standby mode.
4. Enter the downloaded "Zhiyun Gimbal Tools" and upgrade firmware following the instructions indicated in the Firmware Upgrade Tutorial.

Crane-EH002 CRANE 2 Extended Handle (purchase separately)

Installation method:

1. Insert in the two handles from the two sides of the horizontal rod.
2. Tighten the screws on the handles.
3. Loosen the screws on the fixing clamp to install the stabilizer, then tighten the screw to fix it.

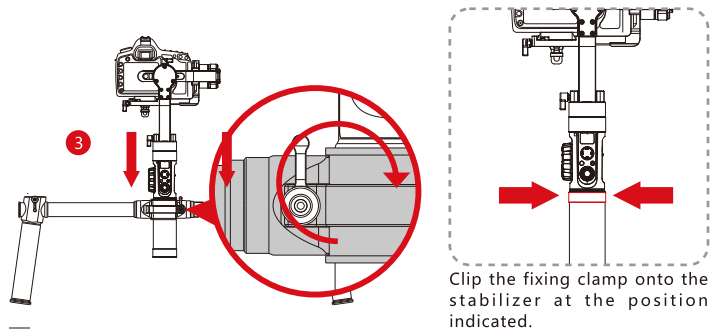
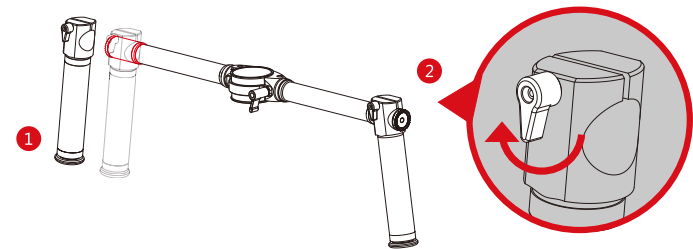

Top down gesture

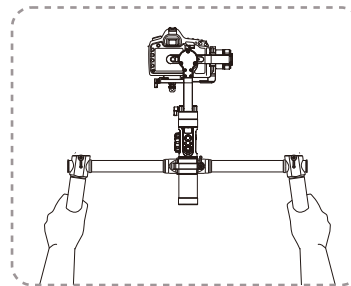

Bottom up gesture

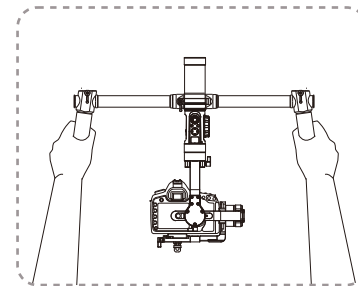

ZW-B02 Remote Controller

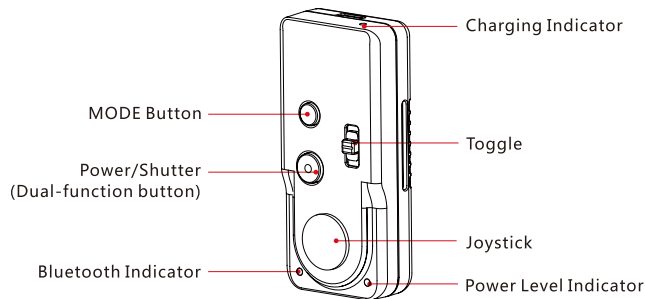

Power/Shutter (Dual-function button):

1. Press for 1-2 seconds to power on/off (enters Master Mode by default):
2. Fully press for 1-2 seconds to power off (the indicator light turned off accordingly)
3. When the stabilizer is connected to camera:
Halfway press the button, under photo mode, to focus; Full press to take single shots; Quick double press (full press) to switch between video and photo shooting.

Combined Button Control

Power Button + toggle: Push the toggle in W direction simultaneously when powering up to enter Slave Mode. This allows firmware upgrade of the remote controller through mobile APP (requires Bluetooth pairing with the smartphone using Zhiyun Assistant).

Power Button + MODE Button: Press the MODE Button simultaneously when powering up to operate quick pairing with the nearest stabilizer.

MODE Button: Switches between gimbal control modes (works like the MODE button on the stabilizer).

Joystick: Controls camera movement (functions the same as the Joystick on the stabilizer.)

Toggle: Allows focusing control of the camera.

Basic Specifications:
 Charging voltage: 5V
 Charging current: 100mA
 Theoretical work time: ≥ 30 hr.
 Built-in Polymer lithium battery capacity: 150mAh
 Emission and received current: 11.9mA
 Operating current: 4.2mA
 Effective control distance: 10M (without blockage)

Power Level Indicator
 90%-100%: quick flash for 4 times each second.
 75%-90%: quick flash for 3 times each second.
 55%-75%: quick flash for 2 times each second.
 30%-55%: quick flash for 1 time each second.
 0%-30%: quick flashing.

Bluetooth Indicator
 No connection: Continuous flashing.
 Connected: Shines solid light.

Charging Indicator
 Charging: ●RED light.
 Charging complete: ●GREEN light.

Mounting Method

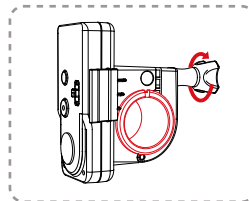

1. Loosen the thumb screw on the back of the remote controller to let loose of the rubber case (as marked red in the Figure).

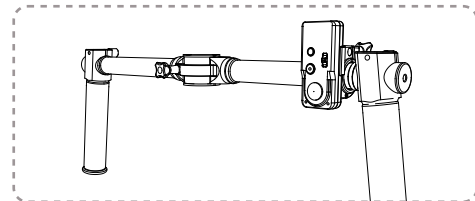

2. Install the remote controller to the extension rod or dual handle for convenient operations (as shown in the Figure above). Fasten up by tightening the thumb screw on the back.

💡 The remote controller turns off automatically when left idle for 2 minutes.

Main body of the remote controller can be easily separated from the mounting buckle for independent use. The mounting buckle is for fix mounting only and will not affect performance of the remote control after separation.

Product model: CRA02



Warranty Period

1. Customers are entitled to replacement or free repair service in case of quality defect(s) found in the product within 15 days upon receipt of the product.
2. Customers are entitled to free repair service from ZHIYUN for any product proven defective in material or workmanship that results in product failure during normal consumer usage and conditions within the valid warranty period, which is 12 months counting from the date of delivery.

This warranty does not apply to the followings

1. Products subjected to unauthorized repair, misuse, collision, neglect, mishandling, soaking, accident, and unauthorized alteration.
2. Products subjected to improper use or whose labels or security tags have been torn off or altered.
3. Products whose warranty has expired.
4. Products damaged due to force majeure, such as fire, flood, lightning, etc.

Warranty Claim Procedure

1. If failure or any problem occurs to your product after purchase, please contact a local agent for assistant, or you can always contact ZHIYUN's customer service through email at SERVICE@ZHIYUN-TECH.COM or website at WWW.ZHIYUN-TECH.COM.
2. Your local agent or ZHIYUN's customer service will guide you through the whole service procedure regarding any product issue or problem you have encountered. ZHIYUN reserves the right to reexamine damaged or returned products.

Customer Information

Customer Name :

Contact No :

Address :

Sales Information

Sales Date :

Prod. Serial No :

Dealer :

Contact No :

#1 Maintenance Record

Service Date :

Signature of Repairman :

Cause of Problem :

Service Result :

 Solved Unsolved Refunded(Replaced)

Website



Weibo



Vimeo



Google+



Facebook



Wechat



Youku



Youtube



Tel: +86-773-2320856

Web: www.zhiyun-tech.com

E-mail: service@zhiyun-tech.com

Address: Creative Industrial Park, GuiMo Road, QiXing District, Guilin
541004, Guangxi, China.



Please download the latest version from www.zhiyun-tech.com

This document is subject to change.

ZHIYUN™ is a trademark of ZHIYUN.

Copyright©2017 ZHIYUN. All rights reserved.