

# JVC

## MULTI FORMAT LCD MONITOR

### DT-G17E

### DT-G21E

### DT-G24E

### DT-G27E

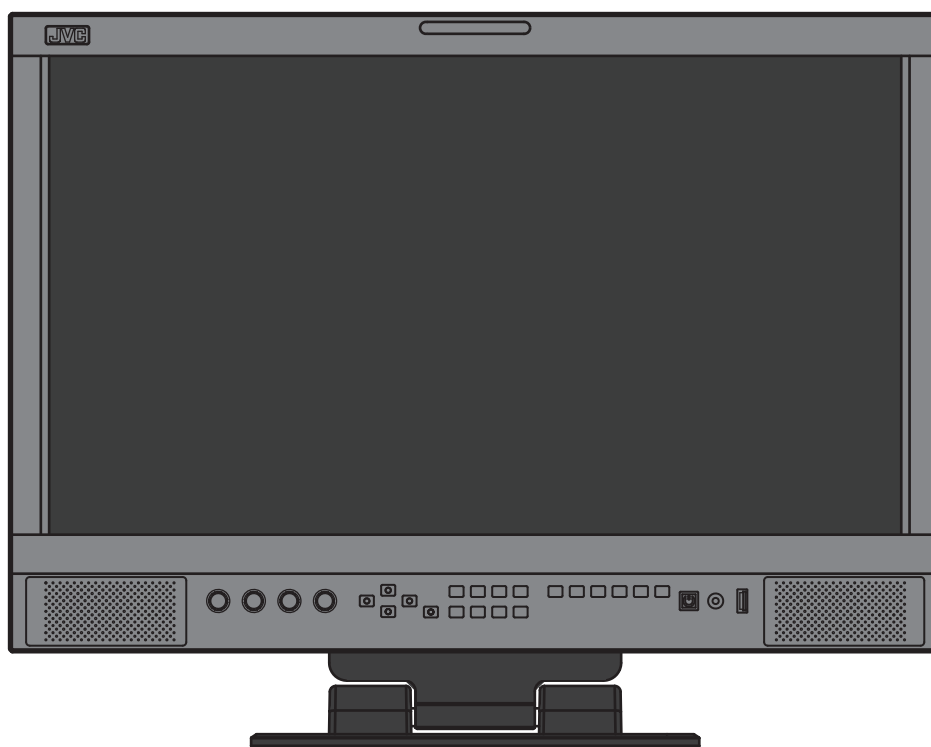

## INSTRUCTIONS



For Customer Use:  
Please read the Instruction Manual carefully  
and retain this information for future reference.

Version: C

# Safety Precautions

 <b>CAUTION</b> <b>RISK OF ELECTRICAL SHOCK</b> <b>DO NOT OPEN</b> 	<p>The lightning flash with arrowhead symbol, within an equilateral triangle is intended to alert the user to the presence of uninsulated “dangerous voltage” within the product’s enclosure that may be of sufficient magnitude to constitute a risk of electric shock to persons.</p> <p>The exclamation point within an equilateral triangle is intended to alert the user to the presence of important operating and maintenance (servicing) instructions in the literature accompanying the appliance.</p>
<p><b>CAUTION:</b> To reduce the risk of electric shock. Do not remove cover (or back). No user serviceable parts inside. Refer servicing to qualified service personnel.</p>	

**WARNING:** TO REDUCE RISK OF FIRE OR ELECTRIC SHOCK, DO NOT EXPOSE THIS APPARATUS TO RAIN OR MOISTURE. NO OBJECTS FILLED WITH LIQUIDS, SUCH AS VASES, SHALL BE PLACED ON THE APPARATUS.

**Warning:** This is a class A product. In a domestic environment this product may cause radio interference in which case the user may be required to take adequate measures.

## IMPORTANT SAFEGUARDS

Electrical energy can perform many useful functions. This unit has been engineered and manufactured to assure your personal safety. But **IMPROPER USE CAN RESULT IN POTENTIAL ELECTRIC SHOCK OR FIRE.** In order not to defeat the safeguards incorporated into this product, observe the following basic rules for its installation, use, and service. Please read these “IMPORTANT SAFEGUARDS” carefully before use.

- All the safety and operating instructions should be read before the product is operated.
- The safety and operating instructions should be retained for future reference.
- All warnings on the product and in the operating instructions should be adhered to.
- All operating instructions should be followed.

### POWER CONNECTION

The power supply voltage rating of this product is AC 120 V (For U.S.A. and Canada) and AC 220 – 240 V (For European countries, Asian countries, and United Kingdom).

The power cord attached conforms to the following power supply voltage and countries. Use only the power cord designated to ensure safety and EMC regulations of each countries.

For U.S.A. and Canada: AC 120 V

For European and Asian countries:  
AC 220 – 240 V

For United Kingdom: AC 220 – 240 V

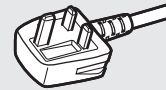
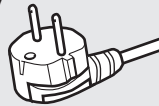

This plug will fit only into a grounded power outlet. If you are unable to insert the plug into the outlet, contact your electrician to install the proper outlet. Do not defeat the safety purpose of the grounded plug.

- This product should be operated only with the type of power source indicated on the label. If you are not sure of the type of power supply of your home, consult your product dealer or local electric power company.

**Warning:**

- Do not use the same power cord for AC 120 V as for AC 220 – 240 V. Doing so may cause malfunction, electric shock or fire.

# Safety Precautions (cont.)

## Under the following conditions,

1. Turn off the power.
2. Unplug this product from the wall outlet.
3. Refer service to qualified service personnel.
  - a) When the product emits smoke or unusual smell.
  - b) When the product exhibits a distinct change in performance—for example, no picture or no sound.
  - c) If liquid has been spilled, or objects have fallen on the product.
  - d) If the product has been exposed to rain or water.
  - e) If the product has been dropped or damaged in any way.
  - f) When the power supply cord or plug is damaged.

- Make enough room for inserting or removing the power plug. Place the product as close to an AC outlet as possible. The main power supply for the product is controlled by inserting or removing the power plug.
- When you install the product in a place where you cannot easily insert or remove the power plug from an AC outlet, do not use the provided power cord holder, and insert or remove the power cord from the AC inlet on the product.
- When the product is left unattended and unused for a long period of time, unplug it from the wall outlet and disconnect the cable system.
- Do not overload wall outlets, extension cords, or convenience receptacles on other equipment as this can result in a risk of fire or electric shock.
- Use only the accessory cord designed for this product to prevent shock.

- Do not install this product in the following places:
  - in a damp or dusty room
  - where the product is exposed to soot or steam, such as near the cooking counter or a humidifier
  - near heat sources
  - where condensation easily occurs, such as near the window
- Do not place this product on an unstable cart, stand, or table. The product may fall, causing serious injury to a child or adult, and serious damage to the product.

The product should be mounted according to the manufacturer's instructions, and should use a mount recommended by the manufacturer.
- Do not use this product near water.
- Be sure to install the product in the place where proper temperature and humidity are kept.

This product becomes hot during its use. Take enough care when handling the product.

Do not attempt to service this product yourself, as opening or removing covers may expose you to dangerous voltages and other hazards. Refer all service to qualified service personnel.

Do not use the product for a long time if the sound is distorted.

- When the product is left unattended and unused for a long period of time, unplug it from the wall outlet and disconnect the cable system.
- Do not overload wall outlets, extension cords, or convenience receptacles on other equipment as this can result in a risk of fire or electric shock.

- Slots and openings in the cabinet are provided for ventilation. These ensure reliable operation of the product and protect it from overheating. These openings must not be blocked or covered.
- Never push objects of any kind into this product through openings as they may touch dangerous voltage points or short-circuit the parts, which could result in a fire or electric shock.
- Never spill liquid of any kind on the product.
- Never place anything on the product. (Placing liquids, naked flames, cloths, paper, etc. on the product may cause a fire.)
- Do not apply any strong shock to the LCD panel. (Do not hit any object against it or push it with a sharp-pointed tool.)
- Do not put heavy objects on the product.
- Do not step on or hang on the product.

- Before connecting other products such as VCR's and personal computers, you should turn off the power of this product for protection against electric shock.
- Do not use attachments not recommended by the manufacturer as they may be hazardous.
- When replacement parts are required, be sure the service technician has used replacement parts specified by the manufacturer or equivalents. Unauthorized substitutions may result in fire, electric shock, or other hazards.
- Upon completion of any service or repairs to this product, ask the service technician to perform safety checks to determine that the product is in proper operating condition.

# Operating Precautions

## IMPORTANT SAFETY INSTRUCTIONS

- 1) Read these instructions.
- 2) Keep these instructions.
- 3) Heed all warnings.
- 4) Follow all instructions.
- 5) Do not use this apparatus near water.
- 6) Clean only with dry cloth.
- 7) Do not block any ventilation openings. Install in accordance with the manufacturer's instructions.
- 8) Do not install near any heat sources such as radiators, heat registers, stoves, or other apparatus (including amplifiers) that produce heat.
- 9) Do not defeat the safety purpose of the polarized or grounding-type plug. A polarized plug has two blades with one wider than the other. A grounding type plug has two blades and a third grounding prong. The wide blade or the third prong are provided for your safety. If the provided plug does not fit into your outlet, consult an electrician for replacement of the obsolete outlet.
- 10) Protect the power cord from being walked on or pinched particularly at plugs, convenience receptacles, and the point where they exit from the apparatus.
- 11) Only use attachments/accessories specified by the manufacturer.
- 12) Use only with the cart, stand, tripod, bracket, or table specified by the manufacturer, or sold with the apparatus. When a cart is used, use caution when moving the cart/apparatus combination to avoid injury from tip-over.
- 13) Unplug this apparatus during lightning storms or when unused for long periods of time.
- 14) Refer all servicing to qualified service personnel. Servicing is required when the apparatus has been damaged in any way, such as power-supply cord or plug is damaged, liquid has been spilled or objects have fallen into the apparatus, the apparatus has been exposed to rain or moisture, does not operate normally, or has been dropped.
- 15) Apparatus shall not be exposed to dripping or splashing and no objects filled with liquids, such as vases, shall be placed on the apparatus.
- 16) Batteries shall not be exposed to excessive heat such as sunshine, fire or the like.
- 17) When discarding batteries, environmental problems must be considered and the local rules or laws governing the disposal of these batteries must be followed strictly.



The LCD panel and backlight have life expectancy. Due to the basic characteristics of the LCD panel, an afterimage or uneven display may occur. It is recommended that you change images occasionally, activate the power saving function, or often turn off the power to reduce the load on the LCD panel. Continuous operations of the LCD panel may accelerate the deterioration.

## Maintenance

**Unplug this product from the wall outlet before cleaning.**

### LCD panel

To avoid irreparable change in appearance of the screen such as uneven color, discoloration, scratches, be careful about the following:

- Do not paste or stick anything using any glues or adhesive tapes.
- Do not write anything on the screen.
- Do not strike the screen with a hard object.
- Avoid condensation on the screen.
- Do not wipe the screen with any liquid such as water. In addition, wiping the screen with water-diluted neutral detergent or solvent such as alcohol, thinner, or benzene may affect the anti-reflection treatment of the screen.
- Do not wipe the screen forcefully.

Wipe stains off the LCD panel with a soft cloth. If the screen gets heavily stained, wipe it with a soft cloth soaked in water-diluted neutral detergent and wrung well, then wipe with a soft dry cloth.

### Cabinet

To avoid the deterioration or damages of the cabinet such as its paint's peeling away, be careful about the following:

- Do not wipe the cabinet using solvent such as alcohol, thinner, or benzene.
- Do not expose the cabinet to any volatile substance such as insecticides.
- Do not allow any rubber or plastic in contact for a long time.
- Do not wipe the cabinet forcefully.

Wipe stains off the cabinet with a soft cloth. If the cabinet gets heavily stained, wipe it with a soft cloth soaked in water-diluted neutral detergent and wrung well, then wipe with a soft dry cloth.

### Ventilation openings

Use a vacuum cleaner to get rid of the dust around the intakes (all the openings). If a vacuum cleaner is not available, use a cloth and wipe it off. Leaving the dust around the intakes may prevent proper temperature control and cause damage to the product.

# Table of Contents

Safety Precautions.....	2
IMPORTANT SAFEGUARDS	2
Operating Precautions.....	4
Maintenance	4
Installation.....	6
Index of Parts and Functions.....	7
Rear panel	7
Front panel	8
Showing Input Signals.....	9
On the Information Display	9
On the Status Display	9
Menu Configuration.....	10
The operation procedure	10
Menu Transition Diagram	10
Main Menu	11
External Control.....	20
Using the UMD control	20
Using the GPI control	20
Using the Webserver IP control	21
Troubleshooting.....	23
Specifications.....	24
General	24
LCD panel	24
Input/output terminals	24
Dimensions	25
Available signals	26

# Installation

- Do not rest your arm on the monitor or lean against the monitor.
- Do not touch the LCD panel when installing the monitor.
- Be sure to install the monitor securely to prevent the monitor from falling over, which may cause damage to the monitor or injury.

## Using the monitor on the stand

The monitor package provides a desktop stand to be installed.

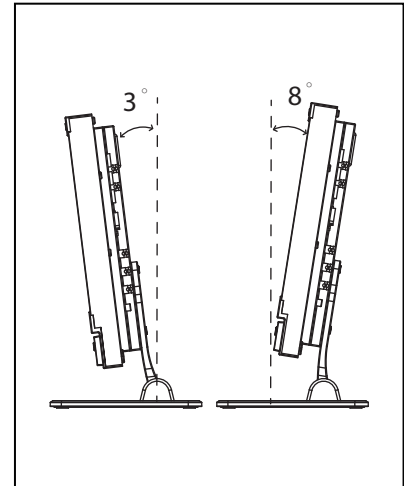
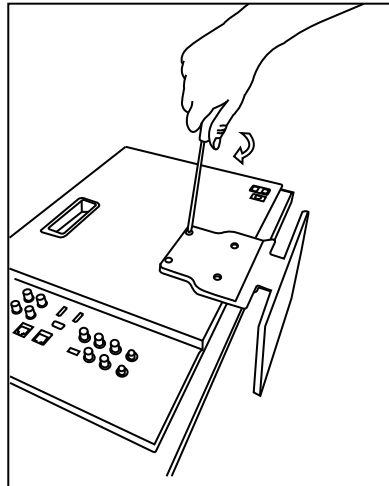
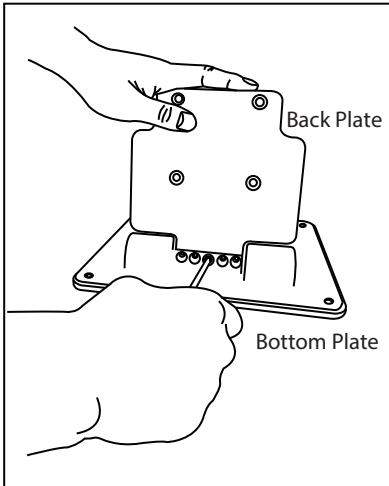

Step1: Install the Back Plate onto the Bottom Plate by supplied 5 screws.

Step2: Install the Back plate onto the monitor by 4 screws.

- The Max tilt angle is down 3° and up 8°, please make sure the setup location is stable.

## Using the monitor on 19" rack (Only DT-G17E)

The DT-G17E provides a pair of rack ears to be installed on standard 19" racks.

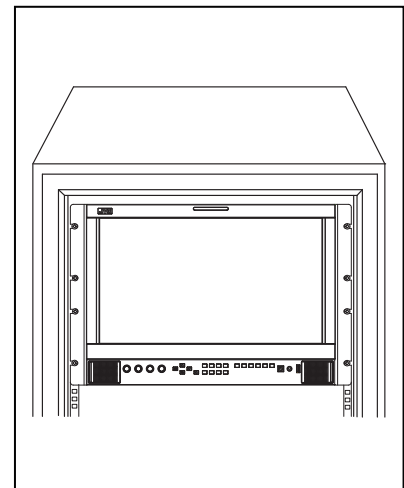
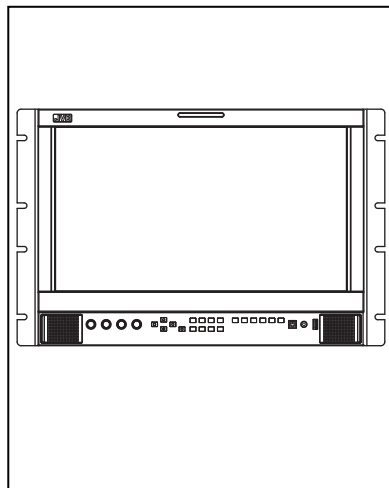
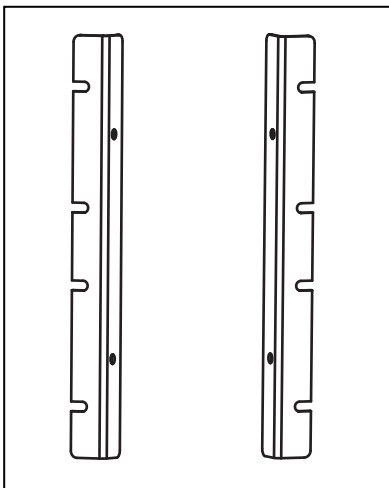

Step1: Fix the supplied rack ears onto left and right side of the DT-G17E monitor, by supplied 4 screws.

Step2: Install the monitor onto the standard 19-inch rack. Occupy 7U height.

### Caution:

Be careful not to pinch your fingers in the gap between the monitor and the stand.

When lifting up the stand, lay the monitor on a cloth with the LCD panel facing down to prevent the LCD panel being damaged.

- Be careful not to pinch your fingers in the moving parts.
- The Max tilt angle is down 7° and up 9°, please make sure the setup location is stable, to prevent the monitor falling down.
- Place the monitor on a mat to avoid scratching the table surface.

# Index of Parts and Functions

## Rear panel

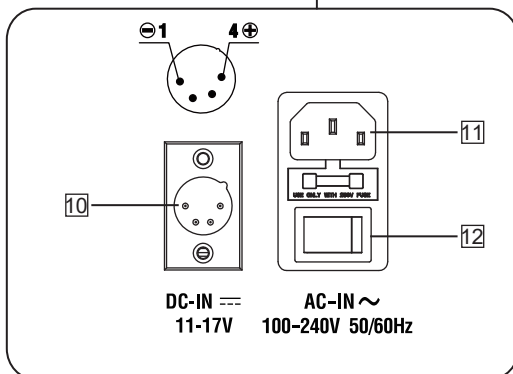
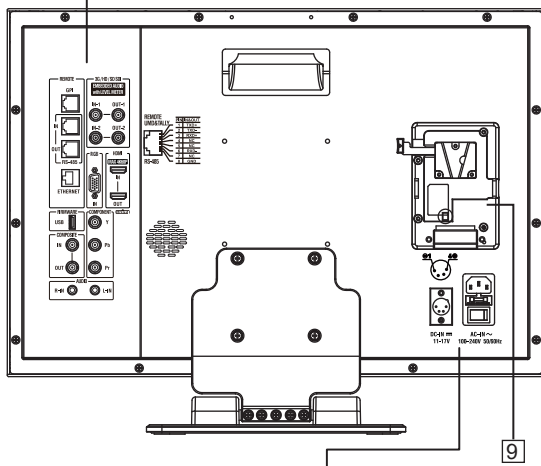
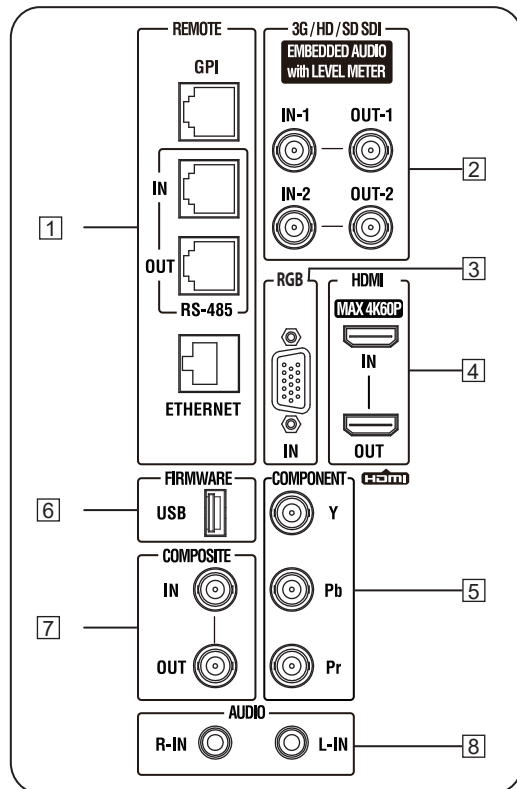

### 1 REMOTE terminal

Terminal for controlling the monitor by an external control. (☞ Page 20.)

### 2 E. AUDIO 3G/HD/SD SDI (IN 1, IN 2) terminals (BNC)

Input / Loop through output terminals for the HD/SD SDI signals.  
● The terminals accept also EMBEDDED AUDIO signals including up to 16 audio channels with a sampling frequency of 48 kHz.

### 3 RGB-IN (mini D-sub 15pin)

Input terminal for analog RGB signal. (☞ Page 27.)

### 4 HDMI terminal

Input / Output terminal for HDMI signals. Will not display or loop output HDCP protected contents. (☞ page 27.)

### 5 Y / Pb / Pr (IN) terminals (BNC)

Input terminals for Component signal.

### 6 USB

For firmware upgrading. Download new firmware to a USB stick, and insert to this USB socket, and operate Menu system to upgrade firmware. (☞ Page 16.)

### 7 CVBS terminals (BNC)

Input / Loop through output terminals for the composite signals.

### 8 AUDIO (IN) terminals (RCA)

Left and Right channels input terminals for the analog audio signals.

● Set signal source as ANALOG (CVBS, RGB, YPbPr), the analog audio can be monitored as audio meters or output via Speaker / Headphone.

### 9 Battery Plate

Install V-mount or Gold mount battery plates to power the monitor by V-mount batteries. (Gold mount plates for option)

### 10 DC-IN terminal

Main (Back up) power input, connect with DC11V-17V 4-pin XLR power adapter. (Pin 1: Negative, Pin 4: Positive)

### 11 AC-IN terminal

Connect the provided AC power cord to an AC outlet, with 250V fuse.

### 12 AC Switcher

Switch to OFF can cut off power completely.

### Note for connections

- Before making any connections, turn off all the equipment.
- User a cord whose plugs correctly match the terminals on this monitor and the equipment.
- Plugs should be firmly inserted; poor connections could cause noise.
- When unplugging a cord, be sure to grasp its plug and pull it out.
- DO NOT connect the power cord until all connections are

# Index of Parts and Functions (cont.)

## Front panel

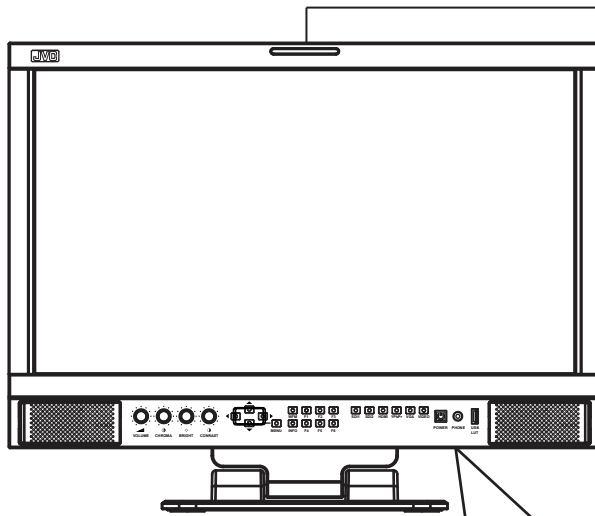

**Tally lamp**  
This lamp is controlled by the tally function of the Make contact terminal. ( External Control on Page 18.)  
You can select the color of the tally lamp from "Green", "Red", or "Yellow".

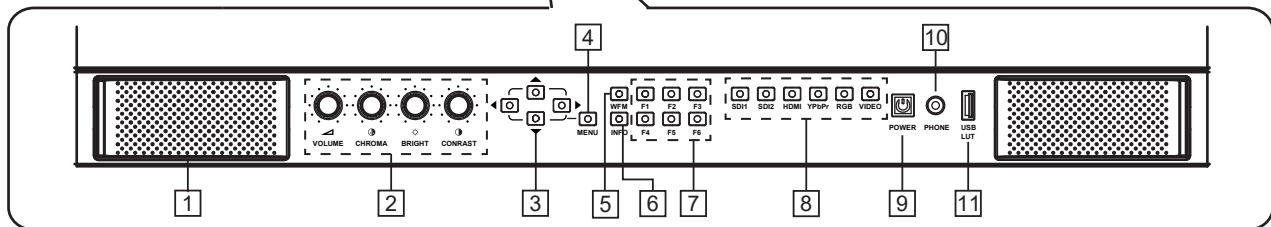

### 1 Speaker:

For SDI/HDMI embedded audio and analog audio monitoring.  
● The speaker will not work if earphone is plugged in.

### 2 Rotary knobs :

VOLUME: Adjust the sound volume from 0-100.  
● When the menu is inactivated, revolve "VOLUME" to adjust the sound volume.  
CHROMA: Adjusts the picture chroma from -50 to +50.  
BRIGHT: Adjusts the picture brightness from -50 to +50.  
CONTRAST: Adjusts the picture contrast from -50 to +50.  
● Directly press BRIGHT/CONTRAST/SATURATION knobs, the parameters will recover to default value 0.

### 3 Direction Keys:

Includes Up, Down, Left, Right 4 direction keys for Menu operation. ( page 10.)

### 4 Menu Key:

Press to switch on Menu system and operate by direction keys.

### 5 WFM Key:

Press to display Waveform scope.  
● Continue to press WFM within 5 seconds, it will open Waveform Sub-Menu for Waveform type selection.

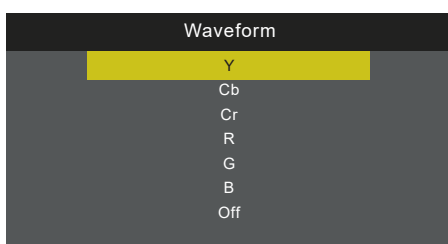

### 6 INFO Key

Press to turn on or turn off all the on screen overlay informations, includes video scopes, audio meters, markers etc.  
● Press INFO can quit Menu system at any time.

### 7 FUNCTION Keys

Provide F1 / F2 / F3 / F4 / F5 / F6 function keys to assign monitor functions and switch on/off quickly. ( page 11.)

### 8 INPUT SELECTION keys

Select input sources directly:  
- SDI 1: the 3G/HD/SD-SDI IN-1 terminal input.  
- SDI 2: the 3G/HD/SD-SDI IN-2 terminal input.  
- HDMI: the HDMI terminal input.  
- Y/Pb/Pr: the Component Y/Pb/Pr terminals input.  
- RGB: the RGB terminal input.  
- VIDEO: the Composite terminal input.  
● The key light will indicate the current input source.

### 9 POWER key

Press to switch on or switch off the monitor.  
● The standby power consumption is less than 0.5W, comply with ErP rules. To complete cut off power, please switch off the AC input switcher or disconnect DC cable or battery.

### 10 PHONE jack

3.5mm earphone socket, for SDI/HDMI embedded audio and analog audio monitoring.

### 11 USB LUT

1. Plug in USB stick to upload 3DLUT cube files, and connect color sensor probes when calibrating the monitor. ( page 17.)  
2. Plug in USB stick with ARM firmware files, and operate Menu system to upgrade ARM firmware. ( page 16.)

# Showing Input Signals

## On the Information Display

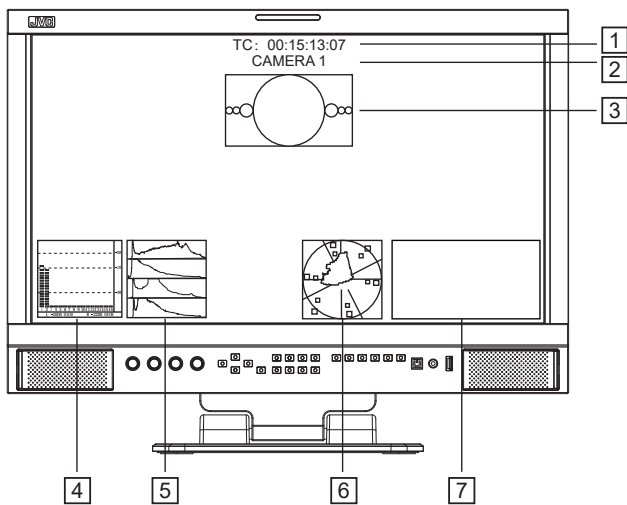

## On the Status Display

Main Menu	Status	
Exit&Status >	HDMI	XXX (1)
Picture >	User Profile	XX (2)
Color Temp >	Color Temp	XXXX (3)
Function Key >	Scan Mode	XXX (4)
GPI >	Freeze Frame	XXX (5)
UMD >	Odd/Even Frame	XXX (6)
Marker >	F1	XXX (7)
Audio >	F2	XXX (7)
Vector >	F3	XXX (7)
Waveform >	F4	XXX (7)
Display >	F5	XXX (7)
System >	F6	XXX (7)
Color Measurement >	Monitor IP	XX.XX.XX.XX (8)
Auto Calibration >	Net Mask	XX.XX.XX.XX (8)
OSD >	Gateway	XX.XX.XX.XX (8)
RGB >	Port	XXX (8)
Key Inhibit >	System Version	XXX (9)

### 1 Time code (SDI)

Under SDI input, the monitor can display Time code information (LTC, VITC1&2). If no Time code info is detected, it will display "TC UNLOCKED".

### 2 UMD

Display TSL 3.1/4.0 UMD or User input Source ID. (see page 12.)

### 3 AFD (SDI)

Under SDI input, the monitor can display AFD information. If no AFD information embedded in the SDI source, it will display "AFD: UNLOCKED".

### 4 Audio VU/PPM meters

Display meters of SDI/HDMI embedded audio or analog audio. The audio meter display channels, on screen positions, markers and background colors are adjustable. (see page 14.)

### 5 Histogram

Parallel display R/G/B/Y histogram for SDI and HDMI video. (see page 15.)

### 6 Vector scope

Display vector scope with 100% and 75% markers for SDI and HDMI video. The vector scope pattern display positions, colors, background are adjustable. (see page 15.)

### 7 Waveform

Display waveform scopes for SDI and HDMI video with markers. The display waveform can be selected from Y/Cb/Cr/R/G/B types, and single line display mode selectable. The waveform display positions, colors, background are adjustable. (see page 15.)

● All the above OSD information display support assign to F1-F6 keys and turn off or turn off the display. (see page 11.)

Press "MENU" button, the main menu will pop up from the left top of the screen, and display the current working status, including:

### 1 Input video format

● If no video detected in current input source, it will display "No Signal".

### 2 User Profile

The monitor can restore 3 user preference settings and display the current user profile info.

### 3 Color Temp

Display the current set color temperature value.

### 4 Scan Mode

Display the current scan mode.

### 5 Freeze Frame

Display the current status of Freeze Frame: ON/OFF.

### 6 Odd/Even Frame

Display the current status of Odd/Even Frame: ON/OFF.  
● Will display gray and not available if the current input signal doesn't support Odd/Even mode.

### 7 F1/F2/F3/F4/F5/F6

Display the current functions that assigned to F1-F6 function keys.

### 8 Monitor IP

Display the IP address, Net Mask, Gateway and Port of the monitor, for Webserver IP remote control function

### 9 System Version

Display the current firmware version.

# Menu Configuration

## The Operation Procedure

- 1 Press the "MENU" button to display the Main Menu.
- 2 Press "▲" and "▼" to select submenu, the selected submenu highlights in yellow; Press "▶" to apply and enter into the selected submenu item.
- 3 Press "▲" and "▼" to select the item to be set from the submenu; Press "▶", the selected item and its parameters will be highlighted in yellow.
- 4 Press "▲" and "▼" to adjust the selected item; Press "▶" or "MENU" to apply and save the settings.
- 5 Press "◀" to quit submenu; Press "◀" again to quit the Main Menu.
- 6 Press "INFO" can quit Menu system at any time.

### Note

The items in gray means not available to set up.

If there is no operation in a period of time, the menu will automatically save settings and quit. The menu quit time can be set from OSD submenu.

If Key Inhibit is turned on, except the Key Inhibit submenu, all other items are not available to operate. Please turn off the key inhibit to enable the Menu operation.

## Menu Transition Diagram

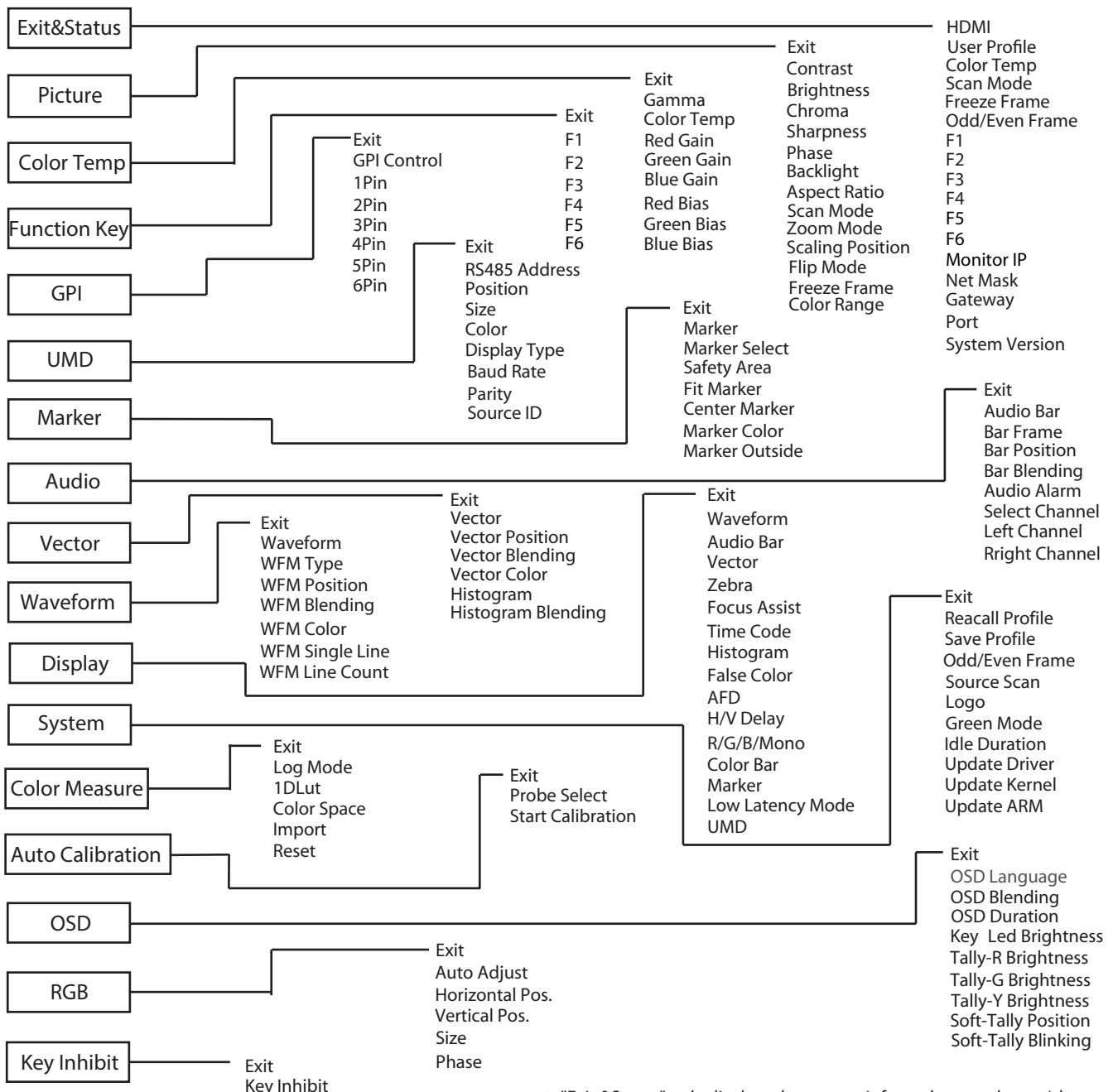

● "Exit &Status" only displays the current info, and cannot be set/changed.

# Menu Configuration (cont.)

## Main Menu

### Picture Function

Setting for the picture quality.

Item	To do	Setting value
Exit	Return to Main Menu	
Contrast	Adjusts the contrast of the display.	-50 to +50
Brightness	Adjusts the brightness of the display.	-50 to +50
Chroma	Adjusts the saturation of the display.	-50 to +50
Sharpness	Adjusts the sharpness of the display.	-50 to +50
Phase	Adjusts the phase of the display.	-50 to +50
Backlight	Adjusts the backlight of the display.	0 to 100
Aspect Ratio	Aspect Ratio setting	16:9, 4:3, Auto
Scan Mode	Scan Mode setting	Normal, Native
Zoom Mode	Zoom Mode setting	Off, Zoom1, Zoom2
Scaling Position	Scaling Position setting	Center, Top Left, Top Right, Bottom Left, Bottom Right
Flip Mode	Flip Mode setting	<div style="display: flex; justify-content: space-around; align-items: center;"> <div style="border: 1px solid black; padding: 2px;">ABCDEF</div> <div style="border: 1px solid black; padding: 2px;">EDCBA</div> <div style="border: 1px solid black; padding: 2px;">FEDCBA</div> <div style="border: 1px solid black; padding: 2px;">EDCBAF</div> </div> <div style="display: flex; justify-content: space-around; margin-top: 2px;"> <span>Off(normal)</span> <span>H Flip</span> <span>V Flip</span> <span>H/V Flip</span> </div>
Freeze Frame	Display setting On: Displayed, Off: Not displayed	On, Off
Color Range	HDMI Color Range setting	Off, 16-235, 0-255

### Color Temperature

Adjusts the R/G/B Gain and Bias, and Gamma Preset

Item	To do	Setting value
Exit	Return to Main Menu	
Gamma	Select the Gamma correction value.	1.8 (equivalent to 1.8) 2.2 (equivalent to 2.2) 2.4 (equivalent to 2.4) 2.6 (equivalent to 2.6)
Color Temp	Select the color temperature Mode.	3200k, 5600K, 6500K, 9300K
Red Gain	Adjusts the Red Gain	0 to 255
Green Gain	Adjusts the Green Gain	0 to 255
Blue Gain	Adjusts the Blue Gain	0 to 255
Red Bias	Adjusts the Red Bias	0 to 255
Green Bias	Adjusts the Green Bias	0 to 255
Blue Bias	Adjusts the Blue Bias	0 to 255

### Function Key

Set short-cut functions for F1-F6

Item	To do	Setting value
Exit	Return to Main Menu	
F1	Assign functions to the function keys F1 - F6 on the front key board	Time Code
F2		WFM Single Line
F3		UMD
F4		False Color
F5		Color Temp
F6		Focus Assist
		Color Bar
		Marker
		R/G/B/Mono
		Zebra
		H/V Delay
		Vector
		AFD
		Audio Alarm

- For example: Set F3 to "R/G/B/Mono" under "Function key" submenu. User can press F3 on the front panel to adjust the parameters of "R/G/B/Mono", and the "R/G/B/Mono" will change and follow the sequence: Blue Only → Red Only → Green Only → Mono → Off.

# Menu Configuration (cont.)

## GPI

Setting functions for external control

Item	To do	Setting value
Exit	Return to Main Menu	
GPI Control *1	Enable GPI control	ON, OFF
1 Pin	Assign functions to the GPI terminals	Red Tally, Green Tally, Yellow Tally, Video, HDMI, SDI1, SDI2, Focus Assist, Low Latency Mode, Odd/Even Frame, Max Backlight, Audio Alarm, UMD, Color Bar, Marker, R/G/B/Mono, H/V Delay, AFD, False Color, Histogram, Audio Bar, Vector, Zebra, Time Code, Color Temp, Flip Mode, Freeze Frame Scan Mode, Aspect Ratio
2 Pin		
3 Pin		
4 Pin		
5 Pin		
6 Pin		

### \*1 GPI Control

The monitor can be operated through external GPI control unit when GPI Control is turned ON. (  page 20.)

## UMD

Source ID and UMD setting

Item	To do	Setting value
Exit	Return to Main Menu	
RS485 Address	Address setting *1	1 to 126
Position	Display position setting	Top, Bottom
Size	Size setting	Normal, Mid-Large, Large
Color	Color setting	Red, White, Black, Blue, Green, Yellow
Display Type	Choose Display Type *2	Source ID, UMD
Baud Rate	Baud Rate setting	38400, 9600, 19200
Parity	Parity setting	Even, None
Source ID	Setting of "Source ID" *3	X X X X X X X X

### \*1 Address setting

- (1) The RS485 address setting is for UMD device connection.
- (2) Support TSL UMD Protocol V3.1 and V4.0, provided by Television System Ltd.
- (3) Set the UMD address, Baud Rate, Parity correct, to display UMD letters and Tally.

### \*2 Choose Display Type

- (1) Select "UMD" to display Source info and Tally info from external control devices of TSL protocol,
- (2) Select "Source ID" to display a user input fixed source info, and Tally info by GPI input.

### \*3 Source ID setting

- (1) Support 8 letters to input.
- (2) Press "MENU" to select each letter space, and press "▲" and "▼" to select letters from:

→ Space → 0~9 → A~Z → a~z → &()\*+,-./:<>\_

- (3) Press "MENU" to confirm current letter and move to next space.

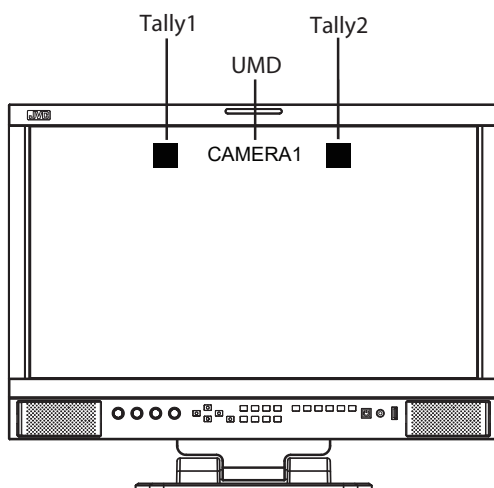

- UMD letters and Tally1/Tally2 from external control devices of TSL 3.1/4.0 protocol

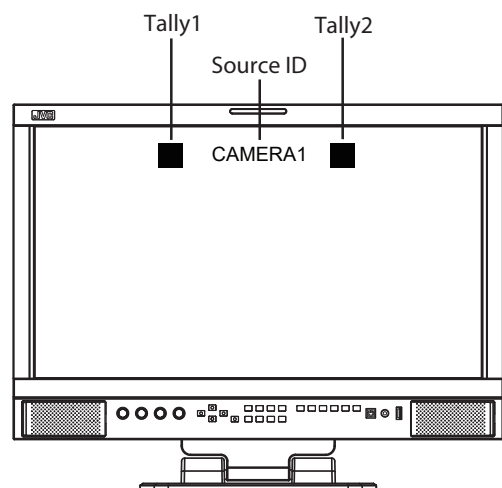

- Source ID letters by manually input, Tally1/Tally2 input via GPI pin assignment.

# Menu Configuration (cont.)

## Marker

Settings for marker functions

Item	To do	Setting value
Exit	Return to Main Menu	
Marker	Turn the marker display on / off	Off, On
Marker Select	Adjust the ratio of marker	Off, 4:3, 13:9, 14:9, 15:9, 16:9, 1.85:1, 2.35:1
Safety Area	Safety area setting	Off, 80%, 85%, 90%, 93%, 95%
Fit Marker *1	Set safety area to fit marker ratio or not	Off, On
Center Marker	Turn the center cross mark on / off	Off, On
Marker Color	Marker color setting	White, Red, Green, Blue, Black, Gray
Marker Outside	Marker outside color setting	Off, Gray, Black

### \*1 Fit Marker

Turn off the Fit Marker, the safety area size percentage is based on screen size.

Turn on the Fit Marker, the safety area size percentage is based on Marker ratio.

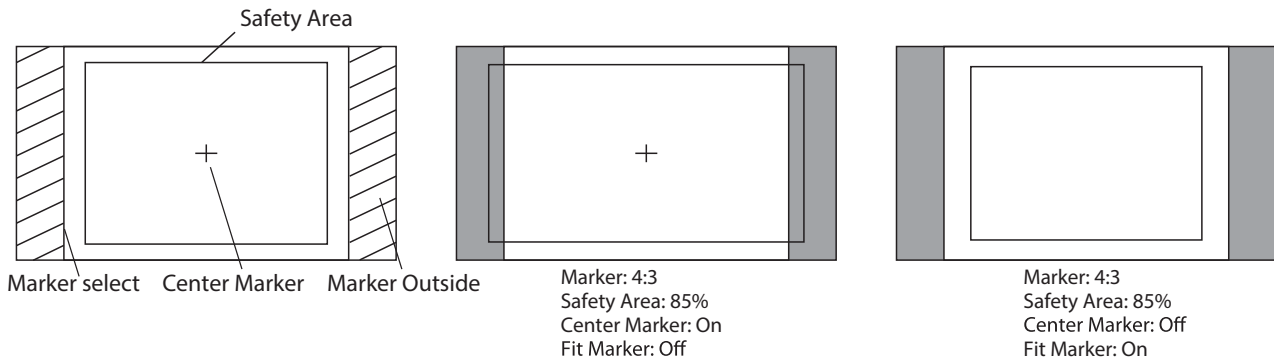

# Menu Configuration (cont.)

## Audio Setting

Setting for the audio meters and channel selection

Item	To do	Setting value
Exit	Return to Main Menu	
Audio Bar	Turn on / turn off the audio bar display	On, Off
Bar Frame	Turn on / turn off the audio bar frame and marks.	On, Off
Bar Position	Change on screen display position of the audio bar.	Top Right, Bottom Left, Bottom Right, Top Left
Bar Blending	Adjust the audio bar pattern background transparency.	Low, Off, High
Audio Alarm*1	Turn on / turn off the audio alarm information	Off, On
Select Channel*2	Select audio channel quantities to display	SDI input: Channel 1-2, 1-8, 1-16 ● For HDMI and ANALOG input, only display Channel 1-2.
Left Channel Right Channel*3	Select the audio left and right channel to be de-embed and output via speaker or headphone.	SDI: Channel 1-16

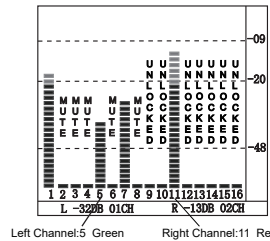
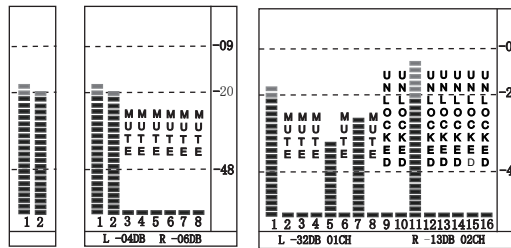
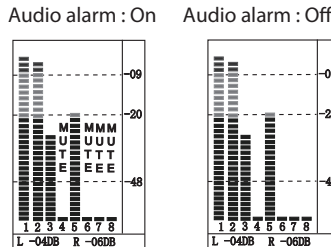
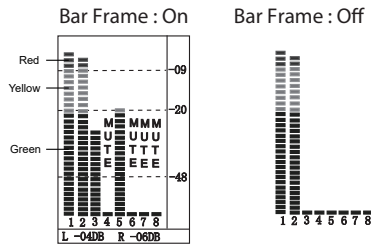

### \*1 Audio Alarm

Switch on "Audio Alarm", the audio bars will display audio alarm info:

No audio detected - display "UNLOCKED".

Audio detected but volume is low - display "MUTE"

### \*2 Select Channel

Under SDI input, Channel 1-2, 1-8, 1-16 display mode can be selected.

Under HDMI input or Analog input, only Channel 1-2 can be selected.

### \*3 Left Channel / Right Channel

When selected display channel is "Channel 1-2", the left and right channel output can be selected from Channel 1-2;

When selected display channel is "Channel 1-8", the left and right channel output can be selected from Channel 1-8;

When selected display channel is "Channel 1-16", the left and right channel output can be selected from Channel 1-16;

In the audio bar, the left channel information will be in green, and the right channel information will be in red.

# Menu Configuration (cont.)

## Vector

Setting for Vector scope and Histogram patterns

Item	To do	Setting value
Exit	Return to Main Menu	
Vector	Turn on/off the Vector scope pattern	Off, On
Vector Position *1	Vector scope pattern on screen display position setting	Bottom Right, Center, Top Left Top Right, Bottom Left
Vector Blending	Vector scope pattern background transparency selection	Off, Low, High
Vector Color	Vector scope pattern color setting	Color, White, Green, False Color
Histogram	Turn on/off the Histogram pattern	Off, On
Histogram Blending	Histogram pattern background transparency selection	Off, Low, High

## Waveform

Setting for Waveform patterns

Item	To do	Setting value
Exit	Return to Main Menu	
Waveform	Turn on/off the Waveform pattern	Off, On
WFM Type	Waveform type select	Y, Cb, Cr, R, G, B
WFM Position *1	Waveform pattern on screen display position setting	Bottom Left, Bottom Right, Center, Top Left, Top Right
WFM Blending	Waveform pattern background transparency selection	Low, High, Off
WFM Color	Waveform pattern color setting	White, Green, False Color
WFM Single Line *2	Turn on/off the Waveform single line mode	Off, On
WFM Line Count	Select a line for the single line waveform	0 to 1079

### \*1: Vector Position / WFM Position

Select 4 corners and center display position of Vector scope pattern and Waveform pattern.

- The Vector scope and Waveform can be displayed together.

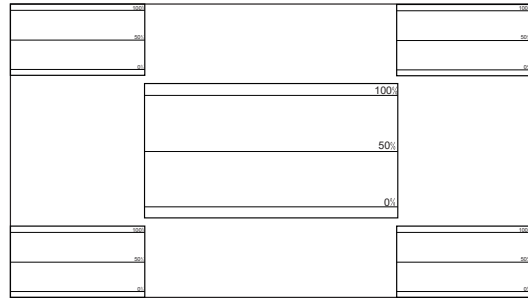
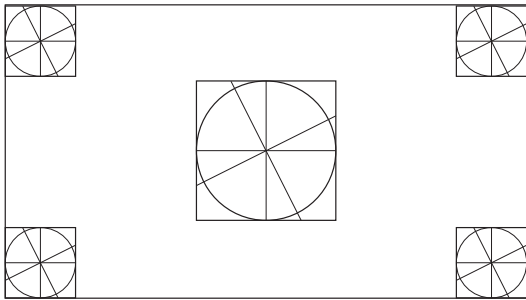

### \*2: WFM Single Line

Turn on the Waveform single line mode, the monitor will display waveform for 1 line. (Only available under SDI input)

Select a line at WFM Line Count by "▲" and "▼".

- Under WFM single line mode, out of Menu system, directly press "▲" and "▼" can select lines.

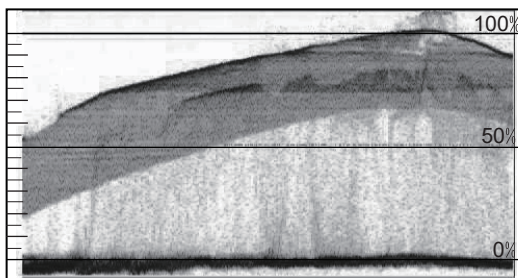

WFM Single Line: Off

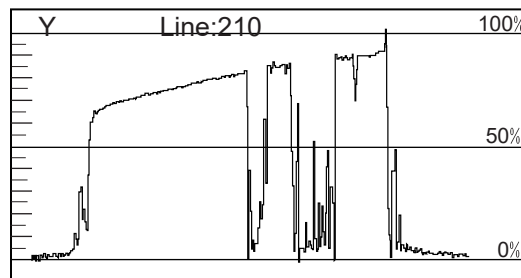

WFM Single Line: On

# Menu Configuration (cont.)

## Display

On/off control center for all function patterns

Item	To do	Setting value
Exit	Return to Main Menu	
Waveform	Turn on/off waveform pattern	Off, On
Audio Bar	Turn on/off audio bar	Off, On
Vector	Turn on/off Vector scope pattern	Off, On
Zebra	Turn on/off Zebra stripes for over exposure check	Off, On
Focus Assist	Turn on/off Focus assist mode and select Focus line color	Off, Blue, Red
Time Code *1	Turn on/off Time code display	Off, On
Histogram	Turn on/off Histogram pattern	Off, On
False Color	Turn on/off False color mode	Off, On
AFD *1	Turn on/off AFD display	Off, On
H/V Delay *1	Turn on/off H/V delay mode	Off, On
R/G/B/Mono	Select Red only, Green only, Blue only or Black/White mode	Blue Only, Red Only, Green Only, Mono
Color Bar	Turn on/off 100% Color Bar display	Off, On
Marker	Turn on/off scale markers display	Off, On
Low Latency Mode *2	Turn on/off Low Latency mode	Off, On
UMD	Turn on/off UMD display	Off, On

\*1: Time Code / AFD / H/V delay / Low Latency Mode Available only under SDI input

\*2: Low Latency Mode Turn on the Low Latency Mode, the video signal latency will be 1 line, and no video functions are available.

## System

General system mode settings and firmware upgrade

Item	To do	Setting value
Exit	Return to Main Menu	
Recall Profile	Loading Factory settings and User presets Factory: Recover all settings to factory setting User 1/2/3: Load the User settings 1/2/3	Factory, User1, User2, User3
Save Profile	Save current User settings User 1/2/3: Save the current settings to User 1/2/3	User1, User2, User3
Odd/Even Frame	Select Odd/Even Frame mode	Off, Odd Mode, Even Mode
Source Scan*1	Automatically scan input signal or not when switch on the monitor	On, Off
Logo	Settings to display Switch on logo or not	On, Off
Green Mode*2	Display settings when in Energy Save mode	Black Backlight, Standby, Gray Backlight
Idle Duration*3	Set an idle time to enter Energy Save mode	30Sec, 1Hour, 2Hours, 4Hours, Off
Update Driver*4	Firmware upgrade: Driver	No, Yes
Update Kernel*5	Firmware upgrade: Kernel	No, Yes
Update ARM*6	Firmware upgrade: ARM	app, ulmage, rootfs.ubi

### \*1 Source Scan

When set to "On", next time switch on the monitor, the monitor will automatically scan the available signal source with the sequence of SDI1→SDI2→HDMI→YPbPr→RGB→Video, and display the first recognized input.

When set to "Off", the monitor will display the input when switched off last time.

### \*2 Green Mode

To comply with ECO save energy regulations, the monitor will go to Green Mode if there's no operation during a period of time. Press any button, the monitor will be back to normal status.

### \*3 Idle Duration

Select a time to enter Green Mode if there's no operation. Set to "Off" will disable Green Mode, please double confirm.

### \*4 / 5 Update Driver / Kernel

Download latest firmware files to USB stick, switch on the monitor, and insert USB stick to the REAR panel USB port of the monitor. (  page 7)

- Enter "Update Driver" - "Yes", or "Update Kernel" - "Yes", the monitor will read Driver or Kernel firmware from USB stick and update automatically.

- During firmware upgrade, the screen will display progress percentage, and restart automatically when any of the Driver or Kernel firmware finished.

### \*6 Update ARM

Download latest firmware files to USB stick, switch on the monitor, and insert USB stick to the FRONT panel USB port of the monitor.

- The firmware files include app, ulmage and rootfs.ubi, enter "app" or "ulmage" or "rootfs.ubi" - "Yes", the monitor will read firmware from USB stick and update automatically.

- During firmware upgrade, the screen will display progress percentage, and after 100% finished, please manually restart the monitor by front Power button OFF/ON.

- For the first time restart after rootfs.ub upgraded, the monitor cannot be operated in 2 minutes. That's normal. Please wait and donot cut off power.

#### USB firmware upgrade

Firmware Upgrading... 37%

Caution ! DO NOT cut off power during firmware upgrade.

#### CAUTION

Please DO NOT cut off power during firmware upgrade.

# Menu Configuration (cont.)

## Color Measure

3rd party 3DLUT calibration, de-log LUTs, User LUTs upload

Item	To do	Setting value
Exit	Return to Main Menu	
Log Mode*1	Select a camera log LUT to convert to Rec.709 Select the uploaded User 3DLUT cube	J-Log1, Log-C, S-Log2, S-Log3, C-Log, V-Log, RedLogFilm, User-Log
1DLut	Select 1DLUT color file	Default, User1, User2
Color Space*2	Switch to LCD panel native color space	ITU709, LCD panel
Import	Upload 3DLUT re-calibrated cube*3, Overwrite the preset De-log 3DLUTs *4, Upload user 3DLUT and 1DLUT files *5	3DLut.cube, J-Log1.cube, Log-C.cube, S-Log2.cube, S-Log3.cube, C-Log.cube, V-Log.cube, RedLogFilm.cube, User-Log.cube, 1DLutUser1.csv, 1DLutUser2.csv
Reset*6	Reset to factory imported 3DLUT cubes	3DLut.cube, J-Log1.cube, Log-C.cube, S-Log2.cube, S-Log3.cube, C-Log.cube, V-Log.cube, RedLogFilm.cube, User-Log.cube

### \*1 Log Mode

The Log Mode is for De-log 3DLUTs and User 3DLUT selection. Select a preset 3DLUT to convert Camera Log Mode to Rec.709. The User-Log is to select the user uploaded 3DLUT.

### \*2 Color Space

Switch to "LCD panel", the monitor will display LCD native color space, and enable color calibration by 3rd party 3DLUT calibration software. Please switch back to "ITU709" when 3rd party calibration finished and return to normal monitoring.

### \*3 Upload 3DLUT re-calibrated cube

Upload position: 3DLut.cube  
Support 17×17×17 cube, calibration under 6500K and Gamma 2.4. Konica Minolta CA-310 color meter dan Spectral CalMAN5 software are recommended.

- Rename the re-calibrated cube as "3DLut.cube" (attention to the cap letters), and copy into USB stick root directory.
- Insert the USB stick onto monitor USB port on the FRONT panel, select "Import" - "3DLut.cube" - "YES" to import the new cube.

### \*4 Overwrite the preset De-log 3DLUTs

Upload position: J-Log1.cube, Log-C.cube, S-Log2.cube, S-Log3.cube, C-Log.cube, V-Log.cube, RedLogFilm.cube.

- Rename the De-log 3DLUT cube as the same file name to the system (attention to the cap letters), and copy into USB stick root directory.
- Insert the USB stick onto monitor USB port on the FRONT panel, select the corresponding logs to import the new cube.

### \*5 Upload user 3DLUT and 1DLUT files

User 3DLUT Upload position: User-Log.cube  
User 1DLUT Upload position: 1DLutUser1.csv, 1DLutUser2.csv

- Rename the User 3DLUT or 1DLUT as the same file name to the system (attention to the cap letters), and copy into USB stick root directory.
- Insert the USB stick onto monitor USB port on the FRONT panel, select the corresponding upload position to import the new file.

### \*6 Reset

For any wrong cubes imported that caused wrong display colors, you can reset the cubes to factory cubes here.

Upload Position	Description
3DLut.cube	Re-calibrated 3DLUT cube
J-Log1.cube	JVC J-Log1 De-log 3DLUT cube
Log-C.cube	ARRI Log-C De-log 3DLUT cube
S-Log2.cube	SONY S-Log2 De-log 3DLUT cube
S-Log3.cube	SONY S-Log3 De-log 3DLUT cube
C-Log.cube	Canon C-Log.cube De-log 3DLUT cube
V-Log.cube	Panasonic V-Log De-log 3DLUT cube
RedLogFilm.cube	Red Log De-log 3DLUT cube
User-Log.cube	User 3DLUT cube upload
1DLutUser1.csv	User 1DLUT csv upload
1DLutUser2.csv	User 1DLUT csv upload

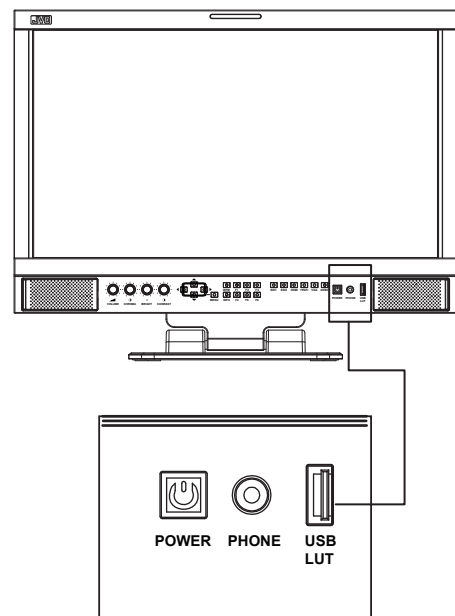

Insert the USB stick onto monitor USB port on the FRONT panel

# Menu Configuration (cont.)

## Auto Calibration

Operations for automatic 3DLUT color calibration

Item	To do	Setting value
Exit	Return to Main Menu	
Probe Select	Select probe that used for the calibration	X-rite Eye One Pro OEM, Jeti Specbos*1
Start Calibration *2	Start the auto calibration	No, Yes

\*1 X-rite Eye One Pro OEM, Jeti Sepcbos

The monitor support the following probe models:

Brand	Model
X-rite	i1 DISPLAY E0DIS3-DC0E
JETI	Specbos 1211

\*2 Start Calibration

The monitor has built in 3DLUT calibration software, and connect the supported color sensor probe directly to the monitor, the monitor can be calibrated automatically without PC connection.

Steps:

(1) Connect the supported color sensor probe to the FRONT USB port of the monitor.

(2) Switch on the monitor, Enter: Menu - Auto Calibration - Start Calibration - YES. The monitor will display:

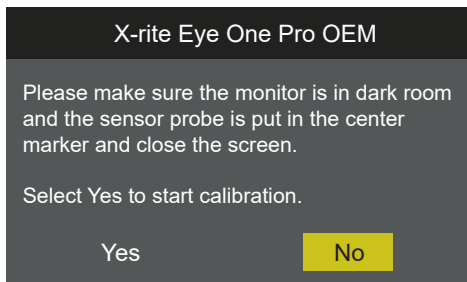

(3) Follow the instructions to place the color sensor probe to the indicated position:

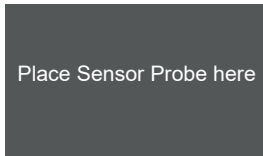

(4) Select "YES", the auto calibration will start. The monitor will generate different color patterns one by one, and display the calibration progress in percentage.

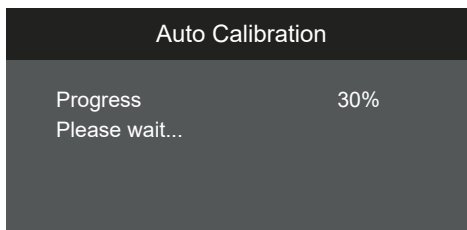

(5) The auto calibration by X-rite will take around 11 minutes to finish, and by Jeti Specbos will take around 45 minutes to finish. Please donot touch the probe during the calibration process.

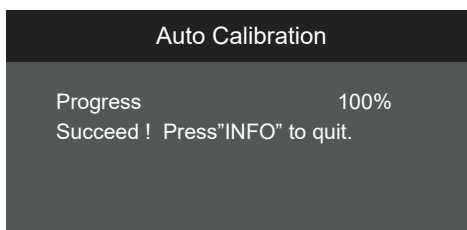

Sensor Probe Connection

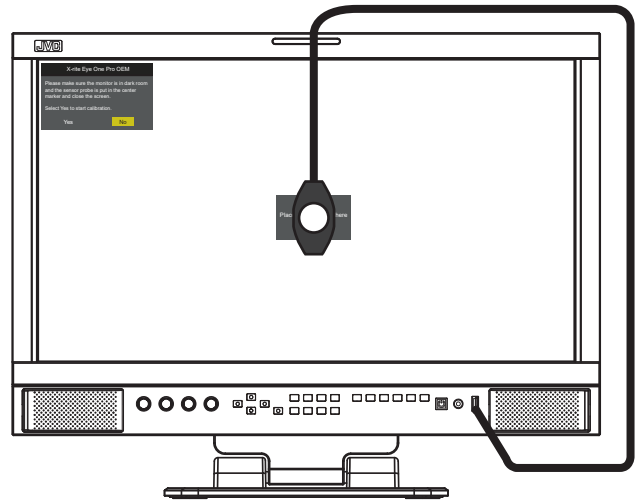

FRONT USB port connection

- You may terminate the Auto calibration process at any time by disconnecting probe USB or pressing the front power button off and on, to restart the monitor.

- Probe not detected

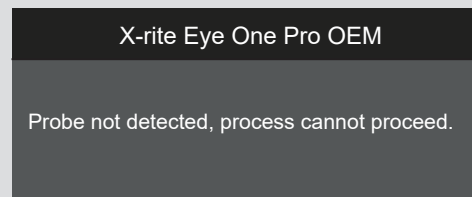

- Re-check and confirm the model type of the color sensor probe.
- Check and make sure the FRONT USB port is well connected.

- Calibration failed

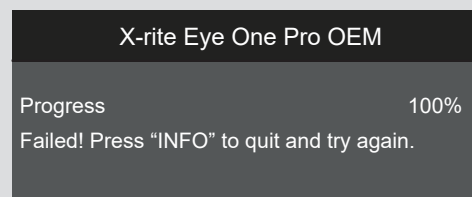

- Make sure the probe sensor is not covered, and placed to the indicated position on the screen.
- Reconnect the USB port and operate calibration again.

# Menu Configuration (cont.)

## OSD

Adjust the OSD display size, color, duration, and TALLY light/keyboard light settings

Item	To do	Setting value
Exit	Return Main Menu	
OSD Language		English
OSD Blending	OSD Blending setting	Low, Medium, High, Off
OSD Duration*1	OSD Duration setting	10Sec,15Sec, 30Sec, 60Sec
Key Led Brightness	Key Led Brightness setting	Low, Medium, High, Off
Tally-R Brightness	Set the brightness of tally when it's red	High, Low, Medium
Tally-G Brightness	Set the brightness of tally when it's green	High, Low, Medium
Tally-Y Brightness	Set the brightness of tally when it's yellow	High, Low, Medium
Soft-Tally Position	Set the position of soft-tally	Top, Bottom
Soft-Tally Blinking	Set the blinking of soft-tally	On, Off

\*1 During this period of time, if there's no operation to the menu, the menu will automatically quit.

## RGB

Adjust the display position, size, phase under RGB input.

Item	To do	Setting value
Exit	Return Main Menu	
Auto Adjust*1	Automatically adjust the RGB signal	
Horizontal Pos.	Adjust the horizontal position of RGB	0-100
Vertical Pos.	Adjust the vertical position of RGB	0-100
Size	Zoom-in/out the signal, default 50	0-100
Phase	Phase setting of RGB signal	0-100

\*1 If RGB signal can't display correct, select "Auto Adjust", and press MENU key, the system will automatically adjust the RGB display.

## Key Inhibit

To lock the keyboard for safety operation

Item	To do	Setting value
Exit	Return Main Menu	
Key Inhibit *1	Key Inhibit setting	Off, Step1, Step2, Step3

\*1 Key Inhibit

Off: Not inhibited.

Step 1: Only Menu button is available. Enter Menu, and Up/Down/Left/Right arrow buttons can be operated to turn off the Key Inhibit.

Step 2: Menu button, F1 - F6 Function keys, and Input Selection buttons are available to operate.

Step 3: Menu button and Input Selection buttons are available to operate.

Under Key Inhibit mode, for any operations to the inhibited buttons, the monitor will display:



# External Control

## About the external control

This monitor has three external control terminals.

- RS-485 terminal (RJ-45):  
Controls the monitor with the RS-485 system.  
The terminal is to connect with TallyMan system of UMD application.
- Make contact terminal (RJ-45):  
Controls the monitor by short-circuiting the corresponding pin terminal to the GND pin terminal, or disconnecting (opening) it.  
The terminal is to assign functions for GPI controlling.
- Webserver IP remote control (RJ-45):  
Controls the monitor by computer webpage.

## Using the UMD control

<Specifications of the RS-485 terminal>

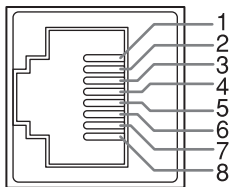

This is a female terminal.

Pin No.	IN terminal signal	OUT terminal signal
1	TXD +	TXD +
2	TXD -	TXD -
3	RXD +	RXD +
4	NC	NC
5	NC	NC
6	RXD -	RXD -
7	NC	NC
8	GND	GND

<Serial communication>

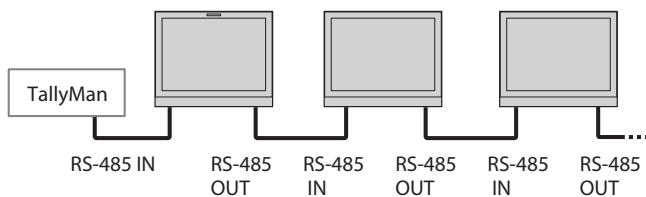

## Using the GPI control

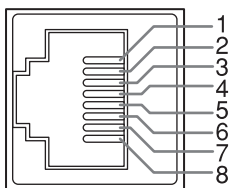

This is a female terminal.

Pin No	Pin name
1	GPI 1
2	GPI 2
3	GPI 3
4	GPI 4
5	GPI 5
6	GPI 6
7	NC
8	GND

To assign the functions to the pin terminals

- 1 Select "GPI" on the Main Menu.
- 2 Set "GPI control" to "ON".
- 3 Select a pin name ("Pin1" - "Pin6") for which you want to assign a function, then select the function you want to assign.

Operation of the external control

- 1 Operate each function by short-circuiting the corresponding pin terminal to the 8th pin terminal (GND) or opening it.

<Functions controlled by the GPI terminal>

Display	Functions to be controlled	Open	Short
Red Tally	Tally light red	Off	Red
Green Tally	Tally light green	Off	Green
Yellow Tally	Tally light yellow	Off	Yellow
Video	Switch to Video input display		*1
HDMI	Switch to HDMI input display		*1
SDI1	Switch to SDI-1 input display		*1
SDI2	Switch to SDI-2 input display		*1
Aspect Ratio	Changes the aspect ratio.		*2
Scan Mode	Changes the scan mode		*3
Color Temp	Color Temp setting		*4
Zebra	Zebra display		*5
Vector	Vector display		*5
Audio Bar	Audio Bar display		*5
Histogram	Histogram display		*5
False Color	False Color display		*5
AFD	AFD display		*5
H/V Delay	H/V Delay display		*5
Marker	Marker display		*5
Color Bar	Color Bar display		*5
UMD	UMD display		*5
Audio Alarm	Audio Alarm display		*5
Freeze Frame	Freeze Frame setting		*5
Time code	Time code display		*5
Low Latency Mode	Low Latency Mode setting		*5
Max Backlight	Max Backlight setting		*5
Focus Assist	Focus Assist setting		*6
R/G/B/Mono	R/G/B/Mono setting		*7
Flip Mode	Flip Mode setting		*8
Odd/Even Frame	Odd/Even Mode setting		*9

\*1 Short-circuit the pin to switch to the input signal.

\*2 For every short-circuit contact, the Aspect ratio will change in the order of 16:9 → 4:3 → Auto.

\*3 For every short-circuit contact, the Scan mode will change in the order of Normal → Native.

\*4 For every short-circuit contact, the Color temperature will change in the order of 6500K → 5600K → 9300K → 3200K.

\*5 For every short-circuit contact, the value will change in the order of On → Off.

\*6 For every short-circuit contact, the Focus assist will change in the order of Off → Red → Blue.

\*7 For every short-circuit contact, the R/G/B/Mono will change in the order of Off → Blue only → Red only → Green only → Mono(B&W).

\*8 For every short-circuit contact, the Flip mode will change in the order of Off → H Flip → V Flip → H&V Flip.

\*9 For every short-circuit contact, the Odd/Even mode will change in the order of Off → Odd Mode → Even Mode.

# External Control (cont.)

## Using the Webserver IP Control

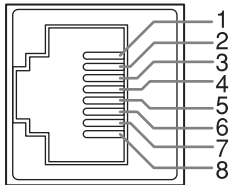

This is a female terminal.

Pin No	Pin name
1	TX+
2	TX-
3	RX+
4	
5	
6	RX-
7	
8	

Connect the monitor ETHERNET port into LAN, and the monitor can be remote controlled by webserver.

### IP Setting

The monitor default IP address is 192.168.1.99  
To change the IP address, please directly connect the monitor with a computer by RJ45 crossover wired cable (one end T568A and another end T568B).

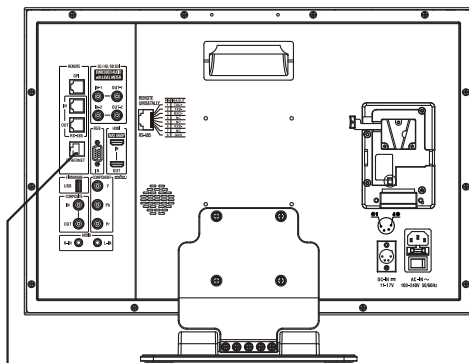

RJ45 crossover wired cable  
one end - T568A  
one end - T568B

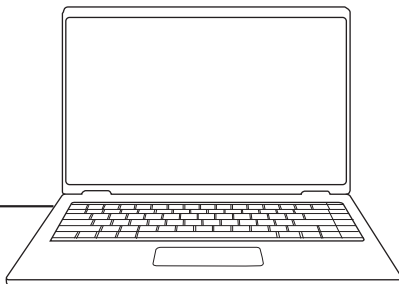

● You may need to re-set computer's IP address when monitor IP is changed.

1) Set the computer Ethernet IP address at: 192.168.1.XXX. (Do not set to the same as monitor IP)

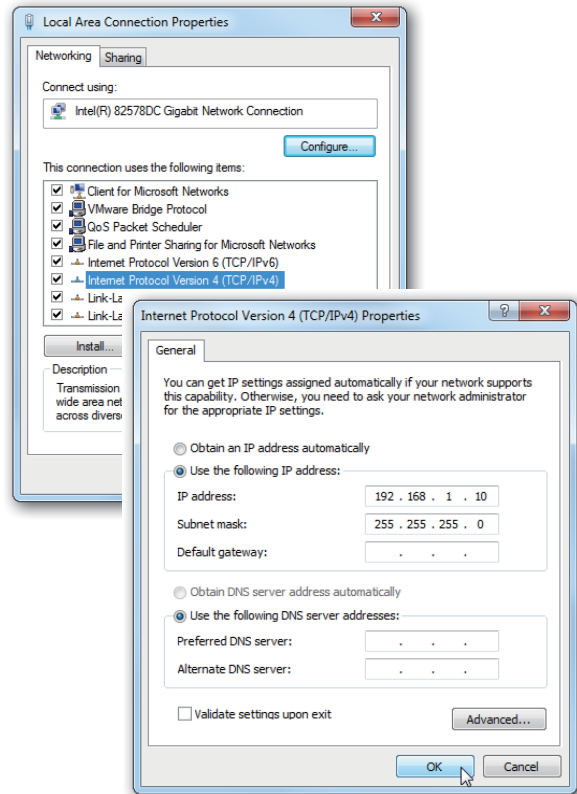

2) Launch any of a web browser on the computer, and enter URL: 192.168.1.99:8080. The webserver control page will be displayed.

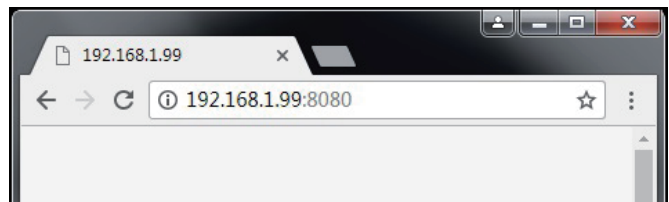

3) You can directly control the monitor by this computer now, and also you can set IP address, Net mask, Gateway, to connect the monitor to a Router and control. (page 22.)

- Use straight-through wired cable for Router connection.
- Please seek help from your webmaster for any network connections.

# External Control (cont.)

## Monitor Control

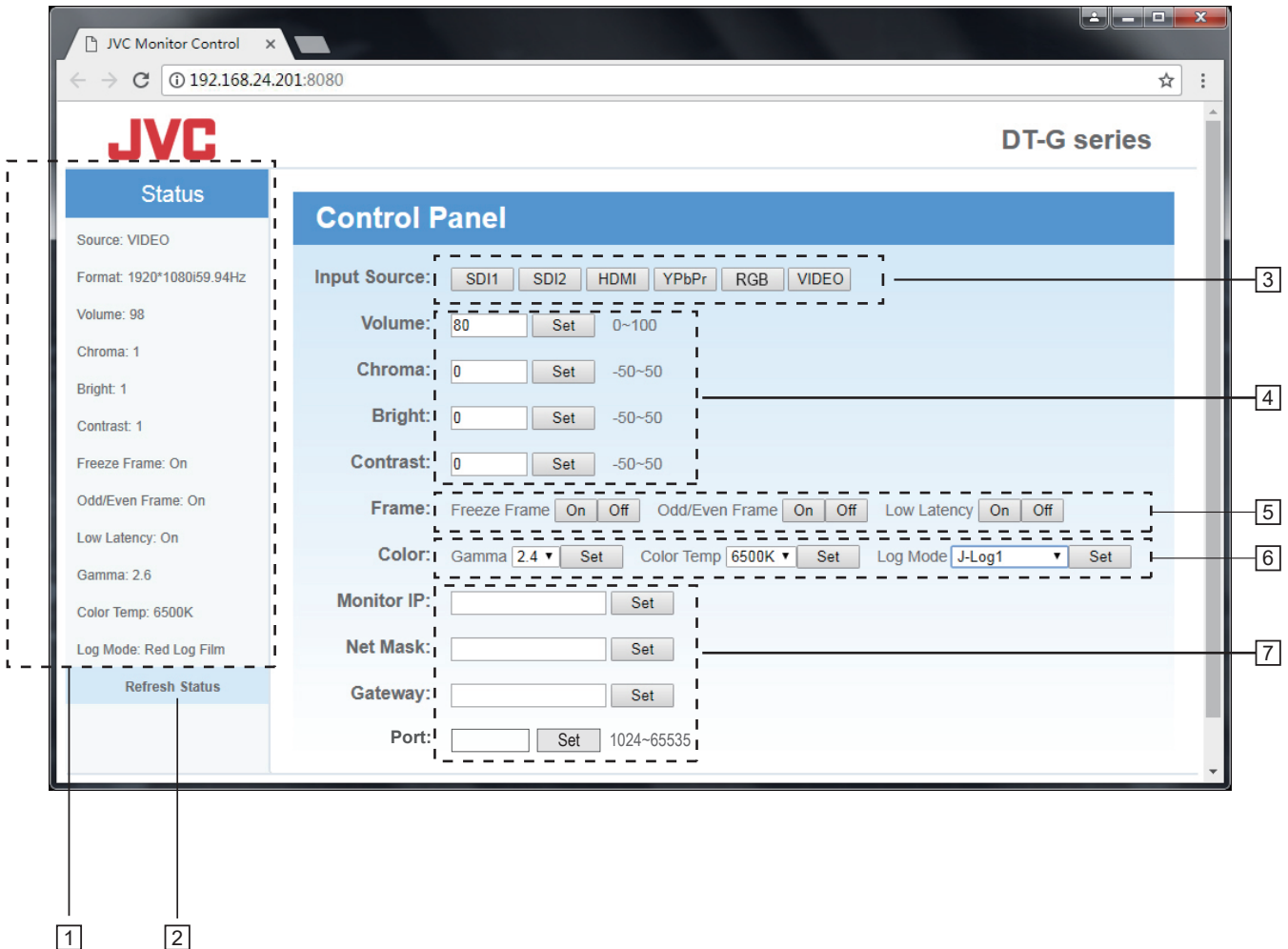

### 1 Status

Read the monitor current status, including: input source, video format, Volume/Chroma/Bright/Contrast setting values, Freeze Frame, Odd/Even Frame, Low Latency status, and Gamma, Color temperature, Log mode status.

### 2 Refresh

After changing settings, please click the Refresh button to see the new status.

### 3 Input Source

Click the input sources to directly switch between SDI1, SDI2, HDMI, YPbPr, RGB and VIDEO.

### 4 VOLUME/CHROMA/BRIGHT/CONTRAST

Directly enter the values to each item, and click SET to apply.

The valid setting ranges:

Volume: 0~100

Chroma: -50~+50

Bright: -50~+50

Contrast: -50~+50

### 5 Frame

Click ON or OFF to turn on/off the frame related settings: Freeze Frame mode, Odd/Even Frame mode, Low Latency mode.

### 6 Color

Settings for color related items:

Gamma: 1.8/2.2/2.4/2.6

Color Temp: 3200K/5600K/6500K/9300K

Log Mode: J-Log1, Log-C, S-Log2, S-Log3, V-Log, C-Log, RedLogFilm, User-Log.

### 7 Monitor IP / Net Mask / Gateway / Port

Enter new IP address, Net Mask address, Gateway address or Port address of the monitor and click Set to apply.

# Troubleshooting

The solutions to common problems related to the monitor are described here. If none of the solutions presented here solve the problem, unplug the monitor and consult an authorized dealer or service center.

Symptom	Probable cause and corrective action	Page
No power supply	● Check AC input switcher on the rear side of the monitor.	7
	● Check DC input voltage or Battery voltage and capacity.	7
	● Press front "POWER" button.	8
No picture with the power on	● Check and select the correct input video.	8
	● Check and confirm the video format is acceptable by the monitor.	24
	● Check the video source output condition and video cable connection.	7
No sound	● Adjust volume level.	8
	● Plug off headphone socket to enable speaker.	8
	● Check the audio source output condition and cable connection.	7
Wrong color	● Adjust picture adjustment knobs on the front panel.	8
	● Set Menu - System - Recall profile to "Default".	16
	● Check B/G/B/Mono mode, Focus assist mode, False color mode.	11, 12, 20
	● Re-calibrate the monitor.	17, 18
Display 3 warning bars *1	● Reset the 3DLUT cubes to factory cubes.	17
Buttons do not work	● Set "Key Inhibit" in the Main Menu to "Off".	19

## \*1 Display 3 warning bars

The monitor will display 3 warning bars if there's error during 3DLUT uploading. The 3 warning bars display green and red to indicate which 3DLUT file has error.



Warning bars	Display Green	Display Red
A	No problem	De-log 3DLUTs or User 3DLUT upload error.
B	No problem	User 1DLUT upload error.
C	No problem	Re-calibrated 3DLUT upload error.

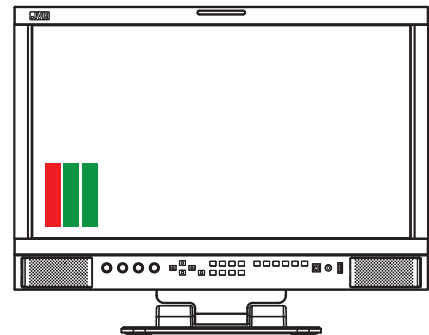

Reset the De-log 3DLUTs, User 3DLUT, User 1DLUT, Re-calibrated 3DLUT from Menu - Color Measurement - Reset.

- The 3 warning bars will disappear if all the A/B/C are Green.

## ● The following are not malfunctions.

- When a still image is displayed for a long time, it may remain indistinctly on the screen after the picture has changed. Though the remaining picture will disappear after a while, there may be a case that it remains for a long period depending on the length of time the still image was displayed for. This is due to the characteristics of the LCD display and is not a malfunction.
- Red spots, blue spots and green spots on the panel surface are a normal characteristic of LCD panels, and not a problem. The LCD panel is built with very high precision technology; however, be aware that a few pixels may be missing or constantly lit.
- The following symptoms are problems only when pictures or sounds are not played back normally.
  - A slight electric shock occurs when you touch the LCD panel.
  - The top and/or rear panel of the monitor becomes hot.
  - The monitor emits a cracking noise.
  - The monitor emits a mechanical noise.

# Specifications

## General

Model name	DT-G17E	DT-G21E	DT-G24E	DT-G27E
Type	Multi format LCD monitor	Multi format LCD monitor	Multi format LCD monitor	Multi format LCD monitor
Screen size	17.3"	21.5"	23.8"	27"
Aspect ratio	16:9	16:9	16:9	16:9
Horizontal/vertical frequency (computer signal)	H: 61.93kHz – 92.9 kHz V: 50 Hz – 75 Hz	H: 61.93kHz – 92.9 kHz V: 50 Hz – 75 Hz	H: 64kHz – 83kHz V: 50 Hz – 75 Hz	H: 54kHz – 83 kHz V: 48 Hz – 75 Hz
	* Some signals within this frequency range may not be displayed			
Compliant video signal format	☞ "Available signals" on page 24			
Format	3G SDI: SMPTE-425M-A/B HD SDI: BTA S-004C, SMPTE292M, SMPTE-425M-A/B, SMPTE-274M, SMPTE-RP211, SMPTE-296M SD SDI: SMPTE-125M, ITU-R BT.656 2K: SMPTE ST 2048-1: 2011 EMBEDDED AUDIO: SMPTE299M, SMPTE272M			
Audio output	Internal speaker: 1.25W+1.25W(8Ω)			
Operating conditions	Operating temperature: 0°C – 40°C (41°F – 95°F) Operating humidity: 20% – 80% (non-condensing) (Slightly variable depending on ambient conditions for installation.)			
Power requirements	AC 120 V / AC 220 – 240 V, 50 Hz/60 Hz; DC11 ~ 17V			
Rated current	0.5A (AC 100V ~ 240V) 2.0 ~ 3.1A (DC11 ~ 17V)	0.5A (AC 100V ~ 240V) 2.1 ~ 3.3A (DC11 ~ 17V)	0.5A (AC 100V ~ 240V) 2.2 ~ 3.5A (DC11 ~ 17V)	0.5A (AC 100V ~ 240V) 2.2 ~ 3.6A (DC11 ~ 17V)
External dimensions (with the stand) (excluding protruding parts)	Width: 419.2 mm (20 3/4") Height: 365.5mm (16 1/4") Depth: 185 mm (7 1/4")	Width: 522.3 mm (20 3/4") Height: 412.4mm (16 1/4") Depth: 185 mm (7 1/4")	Width: 572.7mm (20 3/4") Height: 438mm (16 1/4") Depth: 185 mm (7 1/4")	Width: 643.5 mm (20 3/4") Height: 477.9mm (16 1/4") Depth: 185 mm (7 1/4")
External dimensions (without the stand) (excluding protruding parts)	Width: 419.2 mm (20 3/4") Height: 310.4mm (14 1/8") Depth: 55.8 mm (2 6/16")	Width: 522.3 mm (20 3/4") Height: 357.5mm (14 1/8") Depth: 55.8 mm (2 6/16")	Width: 572.7mm (20 3/4") Height: 386.2mm (14 1/8") Depth: 55.8 mm (2 6/16")	Width: 643.5 mm (20 3/4") Height: 426mm (14 1/8") Depth: 55.8 mm (2 6/16")
Weight(without the stand)	3.95 kg(8.7 lbs)	5.8 kg(12.8 lbs)	6.8 kg(15lbs)	7.95 kg(17.5 lbs)
Weight(with the stand)	5.5kg(12.1lbs)	7.3kg(16.1lbs)	8.3kg(18.3lbs)	9.45kg(20.8lbs)
Accessories	AC power cord x 1, Monitor stand x 1, 19-inch rack ear x 2 (Only DT-G17E)			

## LCD panel

Model name	DT-G17E	DT-G21E	DT-G24E	DT-G27E	
Effective screen size	Width	381.89 mm (15")	476.64 mm (18 3/4")	527.04 mm (20 3/4")	597.89 mm (23 1/2")
	Height	214.81 mm (8 7/16")	268.11 mm (10 9/16")	296.46 mm (11 11/16")	336.31 mm (13 1/4")
	Diagonal	439.42 mm (17 5/16")	546.1 mm (21 1/2")	604.7 mm (23 13/16")	686 mm (27")
Number of pixels displayed	1920 x 1080	1920 x 1080	1920 x 1080	1920 x 1080	
Number of colors displayed	262,144	16.70 million	16.70 million	16.70 million	
Viewing angle (TYP.)	160° (H), 160° (V)	178° (H), 178° (V)	178° (H), 178° (V)	178° (H), 178° (V)	
Brightness (TYP.)	300 cd/m2	250 cd/m2	250 cd/m2	250 cd/m2	
Contrast ratio (TYP.)	700:1	1000:1	1000:1	1000:1	

## Input/output terminals

Video	CVBS	Input/output of composite signal: 1 line, BNC connector x 2, 1 V (p-p), 75Ω * The input (IN) and output (OUT) terminals
	HDMI	HDMI connector x 2(IN and OUT)
	RGB	1 Line, mini D-SUB 15pin x1(IN)
	YPbPr	Y: 1 V(p-p), 75Ω (with sync) Pb : 0.7 V (p-p), 75Ω Pr: 0.7 V (p-p), 75Ω
	E. AUDIO 3G/HD/SD SDI	Digital signal input (compatible with EMBEDDED AUDIO signals): auto detection, 2 line, BNC connector x 2
	E. AUDIO 3G/HD/SD SDI	Digital signal output (compatible with EMBEDDED AUDIO signals): auto detection, 2 line, BNC connector x 2
Audio	AUDIO (IN)	Analog audio signal input: 1 line, RCA connector x 2, 500 mV (rms), high impedance
	AUDIO (MONITOR OUT)	Speaker: 1.25W+1.25W(8Ω) 3.5mm phone
External control	GPI (MAKE)	☞ "Using the GPI control" on page 20.
	UMD (RS-485) IN&OUT	☞ "Using the UMD control" on page 20.
	Ethernet IP (RJ-45)	☞ "Using the Webserver IP control" on page 21.

# Specifications (cont.)

## Dimensions Unit: mm

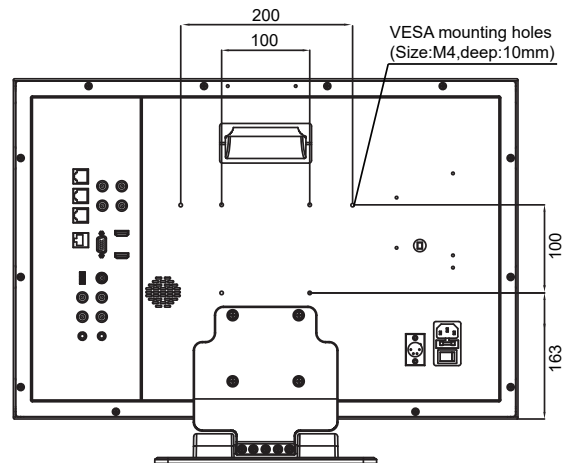
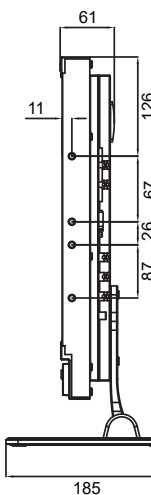
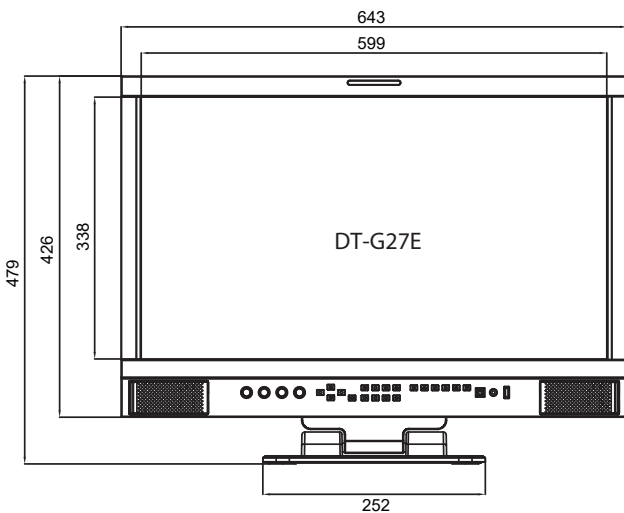
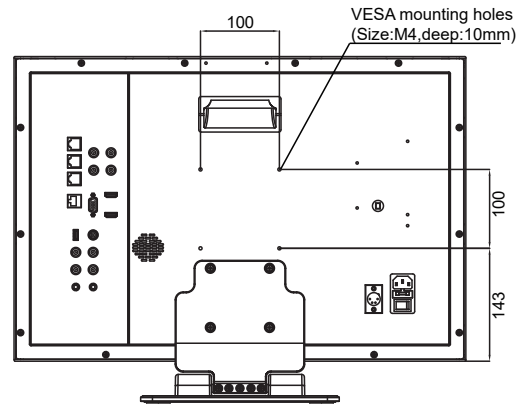
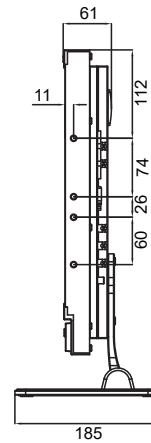
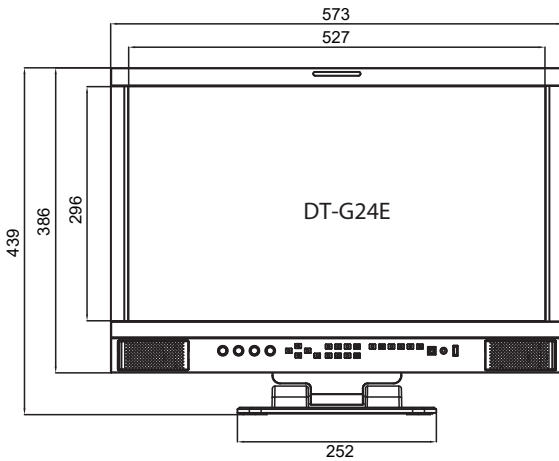
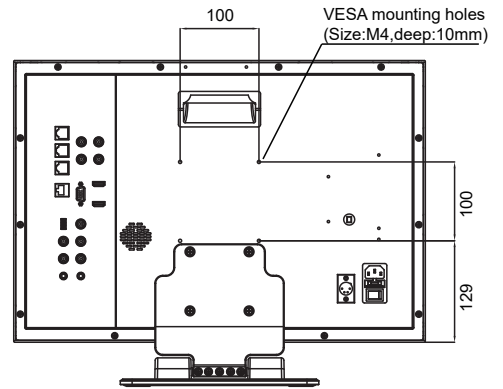
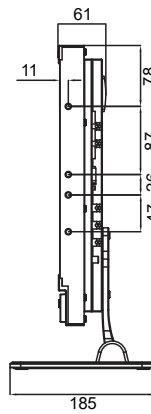
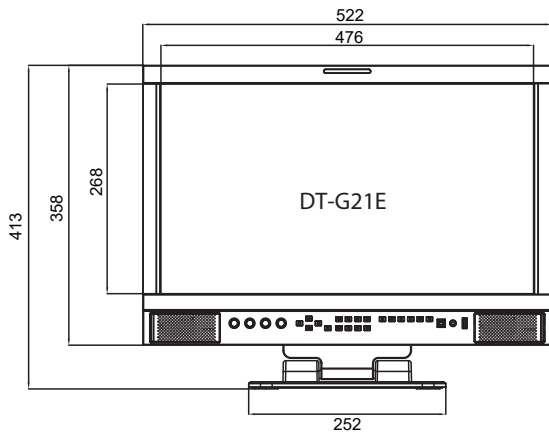
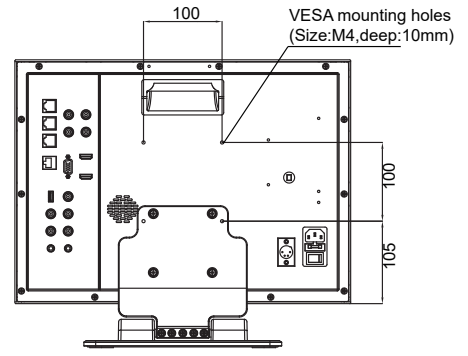
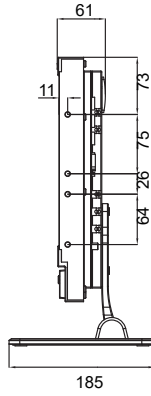
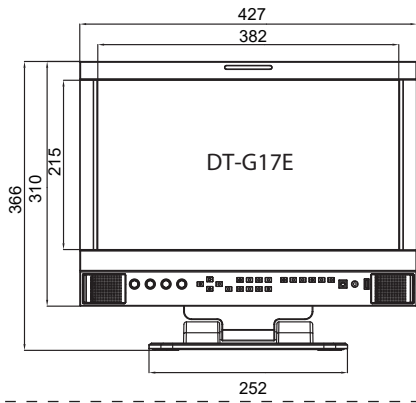

# Specifications (cont.)

## Available signals

The following signals are available for this monitor.

### Video signals

No.	Signal name	Signal format shown in the status display	Input terminal				
			CVBS	YPbPr	VGA	SDI	HDMI
1	NTSC	NTSC	✓	—	—	—	—
2	NTSC 4.43	NTSC	✓	—	—	—	—
3	PAL-M	PAL	✓	—	—	—	—
4	PAL	PAL	✓	—	—	—	—
5	PAL-N	PAL	✓	—	—	—	—
6	SECAM	SECAM	✓	—	—	—	—
7	480/60i	480i	—	✓	—	✓	✓
8	480/59.94i	480i	—	✓	—	✓	✓
9	576/50i	576i	—	✓	—	✓	✓
10	480/60p	480p	—	✓	—	—	✓
11	480/59.94p	480p	—	✓	—	—	✓
12	576/50p	576p	—	✓	—	—	✓
13	640*480/60p	640*480	—	✓	✓	—	✓
14	640*480/59.94p	640*480	—	✓	✓	—	✓
15	720/60p	720p60	—	✓	—	✓	✓
16	720/59.94p	720p60	—	✓	—	✓	✓
17	720/50p	720p50	—	✓	—	✓	✓
18	1080/60i	1080i60	—	✓	—	✓	✓
19	1080/59.94i	1080i60	—	✓	—	✓	✓
20	1080/50i	1080i50	—	✓	—	✓	✓
21	1080/60p	1080p60	—	✓	✓	✓	✓
22	1080/59.94p	1080p60	—	✓	✓	✓	✓
23	1080/50p	1080p50	—	✓	✓	✓	✓
24	1080/30p	1080p30	—	✓	—	✓	✓
25	1080/29.97p	1080p30	—	✓	—	✓	✓
26	1080/25p	1080p25	—	✓	—	✓	✓
27	1080/24p	1080p24	—	✓	—	✓	✓
28	1080/23.98p	1080p24	—	✓	—	✓	✓
29	1080/30PsF	1080i60	—	—	—	✓	✓
30	1080/29.97PsF	1080i60	—	—	—	✓	✓
31	1080/25PsF	1080i50	—	—	—	✓	✓
32	1080/24PsF	1080i50	—	—	—	✓	✓
33	1080/23.98PsF	1080i50	—	—	—	✓	✓
34	2048*1080/23.98p	1080p24	—	—	—	✓	—
35	2048*1080/24p	1080p24	—	—	—	✓	—
36	2048*1080/25p	1080p25	—	—	—	✓	—
37	2048*1080/29.97p	1080p30	—	—	—	✓	—
38	2048*1080/30p	1080p30	—	—	—	✓	—
39	2048*1080/50p	1080p50	—	—	—	✓	—
40	2048*1080/59.94p	1080p60	—	—	—	✓	—
41	2048*1080/60p	1080p60	—	—	—	✓	—
42	2048*1080/50i	1080i50	—	—	—	✓	—
43	2048*1080/59.94i	1080i60	—	—	—	✓	—
44	2048*1080/60i	1080i60	—	—	—	✓	—
44	4096*2160/60p	4096*2160@60	—	—	—	—	✓
45	4096*2160/50p	4096*2160@50	—	—	—	—	✓
46	4096*2160/30p	4096*2160@30	—	—	—	—	✓
47	4096*2160/25p	4096*2160@25	—	—	—	—	✓
48	4096*2160/24p	4096*2160@24	—	—	—	—	✓
49	3840*2160/60p	3840*2160@60	—	—	—	—	✓
50	3840*2160/50p	3840*2160@50	—	—	—	—	✓
51	3840*2160/30	3840*2160@30	—	—	—	—	✓
52	3840*2160/25	3840*2160@25	—	—	—	—	✓
44	3840*2160/24	3840*2160@24	—	—	—	—	✓

✓: Acceptable

—: Not acceptable

For signal formats other than E.Audio 3G/HD/SD SDI input, \*\*/59.94, \*\*/29.97, and \*\*/23.98 will be displayed as \*\*/60, \*\*/30, and\*\*/24 respectively.

# Specifications (cont.)

## Computer signals (preset)

Analog RGB input (COMP./RGB terminals) and DVI input (HDMI terminal):

No.	Signal name	Resolution		Frequency		Scan system
		Horizontal	Vertical	Horizontal (kHz )	Vertical (Hz)	
1	VGA60	640	480	31.5	59.9	Non-interlace
2	SVGA60	800	600	37.9	60.3	Non
3	XGA60	1024	768	48.4	60.0	Non
4	WXGA(1280)	1280	768	47.8	60.0	Non
5	WXGA+60*1	1440	900	55.9	60.0	Non
6	SXGA60*1	1600	1200	75.0	60.0	Non
7	1080/60p*1	1920	1080	67.5	60.0	Non
8	WXGA(1360)	1360	768	47.7	60.0	Non

\*1 No. 5, 6, 7, signals come in, thin lines will become obscured because their signal resolution is higher than the screen resolution.

- Non-preset signals may not be displayed normally even if the frequency is within the acceptable range.

## Specification of the HDMI terminal

Connect it to the HDMI output terminal of a video device.

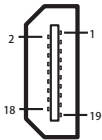

Pin No.	Input signal	Pin No.	Input signal	Pin No.	Input signal
1	T.M.D.S Data 2+	8	T.M.D.S Data 0 shield	15	SCL
2	T.M.D.S Data 2 shield	9	T.M.D.S Data 0-	16	SDA
3	T.M.D.S Data 2-	10	T.M.D.S Clock+	17	DDC/CEC GND
4	T.M.D.S Data 1+	11	T.M.D.S Clock shield	18	+5 V Power
5	T.M.D.S Data 1 shield	12	T.M.D.S Clock-	19	Hot Plug Detect
6	T.M.D.S Data 1-	13	Spare (not connected)		
7	T.M.D.S Data 0+	14	Spare (not connected)		

## Specification of the mini D-SUB15pin terminal

Connect it to the mini D-SUB15pin output terminal of a video device.

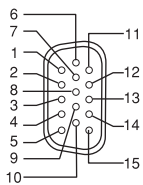

Pin No.	Input signal	Pin No.	Input signal	Pin No.	Input signal
1	Red video signal	7	Green video signal return	13	Horizontal synchronization signal
2	Green video signal	8	Blue video signal return	14	Vertical synchronization signal
3	Blue video signal	9	Not connected	15	I2C clock
4	Not connected	10	Ground		
5	Ground	11	Not connected		
6	Red video signal return	12	I2C data		

## Notice on transportation

This monitor is precision equipment and needs dedicated packing material for transportation. Never use any packing material supplied from sources other than JVC or JVC-authorized dealers.

- For easy understanding, pictures and illustrations are shown by being emphasized, omitted or composed, and may be slightly different from actual products.
- Design and specifications are subject to change without notice.
- All company names and product names mentioned herein are used for identification purposes only, and may be the trademarks of registered trademarks of their respective companies.



## Service Contacts:

**Importer (EU only)**

**JVCKENWOOD U.K. Limited**

12 Priestley Way, London NW2 7BA, UNITED KINGDOM

**Importeur (Nur EU)**

**JVCKENWOOD Deutschland GmbH**

Konrad-Adenauer-Allee 1-11, 61118 Bad Vilbel, DEUTSCHLAND

**Importatore (Solo EU)**

**JVCKENWOOD Italia S.p.A.**

Via G. Sirtori 7/9, 20129 Milano, ITALIA

**Importeur (Alleen EU)**

**JVCKENWOOD Belgium N.V.**

Leuvensesteenweg 248J, 1800 Vilvoorde, BELGIQUE

**Importeur (Alleen EU)**

**JVCKENWOOD Europe B.V.**

Amsterdamseweg 37, 1422 AC Uithoorn, NEDERLAND

---

**Manufacturer**

**JVCKENWOOD Corporation**

3-12, Moriya-cho, Kanagawa-ku, Yokohama-shi, Kanagawa  
221-0022, JAPAN

# JVC



The terms HDMI and HDMI High-Definition Multimedia Interface, and the HDMI Logo are trademarks or registered trademarks of HDMI Licensing Administrator, Inc. in the United States and other countries.