

Mobile Video Studio

HS-600

(SE-600+ITC-50+TLM-170H)



Instruction Manual

www.datavideo-tek.com

Contents

Warnings and Precautions	5
Warranty	6
Disposal.....	6
Packing List.....	6
Product Overview	7
Features	7
Unpacking the HS-600	8
Connections & Controls	9
Keyboard Overview.....	9
Rear Panel	10
Rear Panel Connections	10
Multi-Image Preview	12
Keyboard Controls – Video Switching	13
Main Source and Sub Source Rows	13
BG	13
PIP.....	13
FZ.....	13
FTB.....	13
PVW	13
CUT.....	13
TAKE	13
T-Bar	13
Keyboard Controls – Video Transitions	14
Transition Selection.....	14
Speed / Level Selection.....	14
Keyboard Controls – Video Effects	15
SETTING BUTTON.....	15
LOGO SETTING	15
PIP SETTING	15
LUMA KEY SETTING	15
MOSAIC	15
PAINT	15
B/W.....	15
USER 1 / USER 2	15
BG CLR.....	15
BDR CLR.....	15
Keyboard Controls – Special Effects	16
LUMA KEY PVW	16
LUMA KEY ON.....	16
PIP 1 ENABLE PIP 2 ENABLE	16
LOGO 1 / 2 ON.....	16
F1	16
F2	16

AUX Source Selection.....	16
Settings Menus	17
1: COUNT_DOWN_TIME	17
2: PIP.....	17
3: CG (LUMA KEY)	17
4: LOGO	18
5: VIDEO IN & OUT	18
6: AUDIO MIXER	18
7: MULTI. IMAGE.....	18
8: SYSTEM.....	19
9: STORE RECALL & UPDATE.....	19
10: RESET DVI_IN.....	19
HS-600 Video Layers.....	20
PIP – Picture In Picture function.....	21
PIP Setting	21
Choose your PIP sources	21
Setting the size of each PIP Image.....	21
Setting the Position	21
Setting the Border	21
Preparing the PIP output in the PST_SUB Window	22
No PIP Windows?	22
Sending the prepared PIP to the Program output.....	22
CG (LUMA KEY) function	23
Luma Key Setting.....	23
Choose your LUMA KEY sources	23
KEY level and Transparency.....	23
Setting up a Luma Key overlay with PowerPoint	24
How to set up a Window Matte for Luma Keying.....	25
LOGO function	25
Overview	25
How to replace the sample Logos.....	26
Setting up a Logo	27
Luma Keying with the Logo Function.....	27
DSK - Down Stream Keying - CG (Graphic Overlay).....	27
Video Input Adjustment.....	28
MAIN Video Outputs	29
How to assign Main and Sub source buttons.....	30
AUDIO MIXER function	31
Overview	31
Line level and Mic level	31
Not all Microphones are the same	32
Line and Mic Switch	32
+48V Switch – Phantom power.....	32
Unbalanced RCA connectors.....	32

Balanced 3pin XLR connectors.....	32
Keyboard Controls - Audio	33
Audio Mixer and Faders	33
Master	33
CH1 / CH2 / RCA	33
Audio Peak Meter.....	33
Audio Monitor Button.....	33
A+V Button	33
Headphone Volume Control.....	33
Audio selection for Headphone and Headset socket s	33
Audio Mixer Menu	34
Sending a test tone from the HS-600.....	34
Delaying audio to re-sync video	34
Increasing audio input Gain	34
Audio follows video selection (A+V).....	35
Changing the Multi-Image Preview.....	36
Labels.....	36
GPI / GPO Connections	37
Store and recall function	38
HS-600Tally Outputs	39
How to update the HS-600 Switcher Firmware	39
Optional DV and SDI output board	40
ITC-50 Intercom.....	41
ITC-50 connections and Controls	41
ITC-100SL Slave Unit	42
Cable Assignments Headset, Jack plug and 5pin XLR	43
CB-3 XLR cable / 5pin XLR Connector on ITC-100SL	43
ITC-100SL Belt pack 3.5mm Jack socket Headset connector.....	43
HS-600 Monitor.....	44
RS-422 Protocol	47
Dimensions.....	47
HS-600 Switcher Specification.....	48
ITC-50 Specification.....	49
ITC-100SL Specification	49
Monitor Specification.....	49
Service and Support	50

Disclaimer of Product and Services

The information offered in this instruction manual is intended as a guide only. At all times, Datavideo Technologies will try to give correct, complete and suitable information. However, Datavideo Technologies cannot exclude that some information in this manual, from time to time, may not be correct or may be incomplete. This manual may contain typing errors, omissions or incorrect information. Datavideo Technologies always recommend that you double check the information in this document for accuracy before making any purchase decision or using the product. Datavideo Technologies is not responsible for any omissions or errors, or for any subsequent loss or damage caused by using the information contained within this manual. Further advice on the content of this manual or on the product can be obtained by contacting your local Datavideo Office or dealer.



Warnings and Precautions

1. Read all of these warnings and save them for later reference.
2. Follow all warnings and instructions marked on this unit.
3. Unplug this unit from the wall outlet before cleaning. Do not use liquid or aerosol cleaners. Use a slightly damp cloth for cleaning.
4. Do not use this unit in or near water.
5. Do not place this unit on an unstable surface, cart, stand, or table. The unit may fall, causing serious damage.
6. Any slots and openings on the case top, back, and bottom are provided for ventilation. To ensure safe and reliable operation of this unit, and to protect it from overheating, do not block or cover these openings. Do not place this unit on a bed, sofa, rug, or similar surface, as the ventilation openings may become blocked. This unit should never be placed near or over a heat source or radiator. This unit should not be placed in a built-in installation unless proper ventilation is provided.
7. This product should only be operated from the type of power source indicated on the marking label of the AC adapter. If you are not sure of the type of power available, consult your Datavideo dealer or your local power company.
8. Do not allow anything to rest on the power cord. Do not locate this unit where the power cord will be walked on, rolled over, damaged or otherwise stressed.
9. If an extension cord must be used with this unit, make sure that the total of the ampere ratings on the products plugged into the extension cord do not exceed the extension cord rating.
10. Make sure that the total amperes of all the units that are plugged into a single wall outlet do not exceed 15 amperes.
11. Never push objects of any kind into this unit through the case ventilation slots, as they may touch dangerous voltage points or short out parts that could result in risk of fire or electric shock. Never spill liquid of any kind onto or into this unit.
12. Except as specifically explained elsewhere in this manual, do not attempt to service this product yourself. Opening or removing covers that are marked "Do Not Remove" may expose you to dangerous voltage points or other risks, and will void your warranty. Refer all service issues to qualified service personnel.
13. Unplug this product from the wall outlet and refer to qualified service personnel under the following conditions:
 - a. When the power cord is damaged or frayed;
 - b. When liquid has spilled into the unit;
 - c. When the product has been exposed to rain or water;
 - d. When the product does not operate normally under normal operating conditions. Adjust only those controls that are covered by the operating instructions in this manual; improper adjustment of other controls may result in damage to the unit and may often require extensive work by a qualified technician to restore the unit to normal operation;
 - e. When the product has been dropped or the case has been damaged;
 - f. When the product exhibits a distinct change in performance, indicating a need for service.

Warranty

Standard Warranty

- Datavideo equipment is guaranteed against any manufacturing defects for one year from the date of purchase.
- The original purchase invoice or other documentary evidence should be supplied at the time of any request for repair under warranty.
- Damage caused by accident, misuse, unauthorized repairs, sand, grit or water is not covered by this warranty.
- All mail or transportation costs including insurance are at the expense of the owner.
- All other claims of any nature are not covered.
- Cables & batteries are not covered under warranty.
- Warranty only valid within the country or region of purchase.
- Your statutory rights are not affected.

Two Year Warranty

- All Datavideo products purchased after 01-Oct.-2008 qualify for a free one year extension to the standard Warranty, providing the product is registered with Datavideo within 30 days of purchase. For information on how to register please visit www.datavideo-tek.com or contact your local Datavideo office or authorized Distributors.
- Certain parts with limited lifetime expectancy such as LCD Panels, DVD Drives, Hard Drives are only covered for the first 10,000 hours, or 1 year (whichever comes first).

Any second year warranty claims must be made to your local Datavideo office or one of its authorized Distributors before the extended warranty expires.

Disposal



For EU Customers only - WEEE Marking

This symbol on the product indicates that it should not be treated as household waste. It must be handed over to the applicable take-back scheme for the recycling of Waste Electrical and Electronic Equipment. For more detailed information about the recycling of this product, please contact your local Datavideo office.

Packing List

Item	Description	Quantity
1	HS-600 Mobile Studio	1
2	AC Power Cord	1
3	Switching Adaptor DC 12V / 5A XLR 4pin Female	1
4	LED USB Keyboard light	1
5	ITC-100SL Belt Packs for ITC-50	4
6	CB-3 XLR 5pin cable for ITC-50 Length 20m	4
7	MC-1 headsets for ITC-50	4
8	TD-1 Tally lights for ITC-50	4
9	CB-7 cable for TD-1 Length 1.2m	4
10	MC-2 XLR Gooseneck Mic	1
11	HS-600 Instruction Manual	1

Product Overview

Although live HD production is now popular in the world there are still lots of reasons for good quality SD based productions. Datavideo understand that our customers need a cost effective and flexible SD mobile studio. Our solution to this need is the Datavideo HS-600 mobile studio.

The Datavideo HS-600 is built around the SE-600 switcher which has useful broadcast grade effect and functions as well as a simple four channel audio mixer. There are six Composite video inputs and two computer based DVI inputs. The HS-600 also offers a two PIP function and Luma key as well as Composite, DV* and SDI* program outputs. A Multi-image preview output provides combined Source, AUX, Preview and Program screens to one monitor. Other features include an Audio Peak Meter, a countdown timer and a dual Logo store. The HS-600 enables you to switch seamlessly between video and audio sources and blends high-quality digital content on the fly, even without external gen-lock, thanks to a built in time base corrector.

We believe the Datavideo HS-600 is designed to meet your needs whether you're working in Worship, Education, conducting a live Outside Broadcast or shooting inside a Production Studio. That's Datavideo, sharing the value!

***Optional DV & SDI board** – please check with your dealer

Features

- Inputs:**
 - Six Composite video inputs (BNC)
 - Two DVI computer based inputs
 - Two XLR balanced Audio inputs (Ch1 1/L & Ch1 2/R with MIC (48V Phantom Power) switch)
 - Two RCA / Phono Aux Audio Line level inputs

- Outputs:**
 - Multi-Image Preview with Video Sources, AUX1, AUX2, Preview and Program images
 - Multi-Image Preview includes menu selection area, countdown timer and audio level indicator
 - Multiple Program outputs (recorder/ program out/ streaming)
 - Two Auxiliary Composite outputs (User selectable)
 - Two 6 pin IEEE-1394 DV Program outputs (***optional board** – please check)
 - Two SDI Program outputs (***optional board** – please check)
 - Two XLR balanced Mixed Audio outputs (Stereo/Mono)
 - Two Line level RCA / Phone Mixed Audio outputs (Stereo/Mono)

- Effects:**
 - Choice of 14 Wipes with optional coloured border or A/B Dissolve
 - Single or Dual PIP window effects with optional coloured border
 - Luma key x1
 - LOGO: display up to two logos on the mixed program output
 - One frame still store memory as a source
 - SMPTTE pattern out (colour bars) or selected background colour

- Audio Mixer:**
 - LED audio Peak Meter / audio-level indicator
 - Audio follows video button (A+V)
 - Headphone Audio Monitoring button for mixer, LCD panel or ITC-50 talkback audio
 - Audio faders for simple mixing of XLR and RCA inputs

- Controls:**
 - Rubber keys for quiet and confident operation
 - T-Bar for manual transitioning
 - Brightness, Contrast, Saturation and RGB correction
 - Special control keys
 - Fade to solid colour (background colour can be selected)
 - Transition speed keys (speed of transition can be programmed)
 - AUX source keys
 - RS422
 - GPO Trigger out: trigger the external video player with delayed transition effect
 - GPI trigger in
 - Tally output via ITC-50 belt packs

- SD Card Slot:** For software updates as well as storing Logos
- Power Input:** Locking 4pin XLR DC 12V / 3A

Unpacking the HS-600



Place the HS-600 on a level desk or surface. The carry handle will be at the front facing the operator's position.



To open the HS-600 monitor lid slide the thumb catches in the direction shown to their outer most position. Then lift the monitor lid upwards away from the keyboard and carry handle.

The rear connections cover needs to be removed before the input and output connections can be seen.



To remove the rear connections cover, unscrew the two thumb screws by turning them to the left, as shown above.

Connections & Controls

Keyboard Overview



- | | |
|--|--|
| 1. Monitor panel controls – See page 44 | 10. Effects and Menu selection |
| 2. ITC-50 talkback system – See page 41 | 11. Luma key, PIP and Logo activation keys |
| 3. Audio mixer controls – See page 33 | 12. Aux output selection |
| 4. Headphone volume control | 13. Manual T-Bar |
| 5. Headphone ¼" socket (6.3 mm) | 14. Main source selection row |
| 6. Headphone audio selection for items 5 & 7 | 15. Sub source selection row |
| 7. Headset 3.5mm socket for ITC-50 | 16. Transition speed level |
| 8. SDHC Card Slot for firmware and logos | 17. Cut & Take keys |
| 9. Transition selection | |



Rear Panel

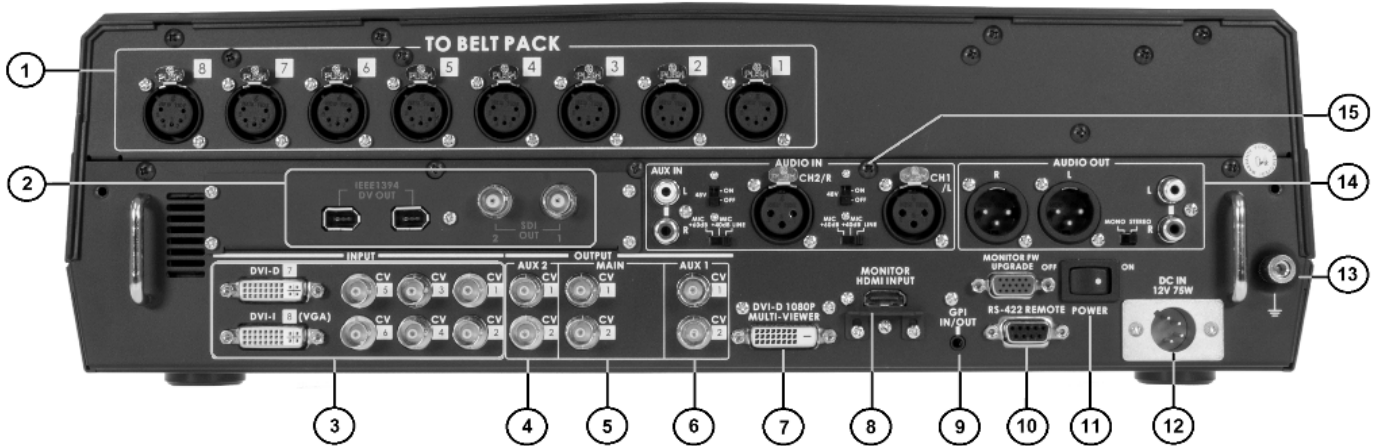

** HS-600 Rear panel shown with Optional DV and SDI output board fitted – please check with your dealer **

- | | |
|--|---|
| <ol style="list-style-type: none"> 1. ITC-50 Belt Pack connectors incl. Tally 2. **Optional DV and SDI output board** 3. Video inputs, 2x DVI and 6x Composite 4. Aux 2 outputs, 2x Composite 5. Main outputs (PGM), 2x Composite 6. Aux 1 outputs, 2x Composite 7. Multi-Image Preview, 1x DVI 8. HDMI input – Monitor only – not mixed 9. GPI / GPO 3.5mm socket | <ol style="list-style-type: none"> 10. RS-422 Remote 11. Power ON / OFF switch 12. DC input socket, 4pin XLR 13. Earth connector 14. Analogue audio outputs, 2x RCA, 2x XLR 15. Analogue audio inputs, 2x RCA, 2x XLR
Includes +48V switch for XLR inputs
Line, Mic +40, Mic +60 option on XLR inputs |
|--|---|

Rear Panel Connections



ITC-50 Belt Pack 5pin XLR connectors

These eight connectors can each be connected by a cable to a ITC-50 belt pack.



Optional DV and SDI output board

This board supplies 2x DV25 outputs and 2x SDI outputs. Please check with your dealer as this card is not fitted to all models.

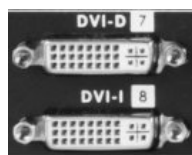

DVI Inputs

DVI-D (Input 7) digital signal input connector.
DVI-I (Input 8) digital or analogue signal input connector.

Resolutions of 1280x1024 @ 60Hz or 1024x768 @ 60Hz should be compatible depending on your graphics card or computer.



Composite (CV) Inputs 1~6

Composite video input: takes a BNC connector from the composite output of a VCR, camera, DVD player, etc.

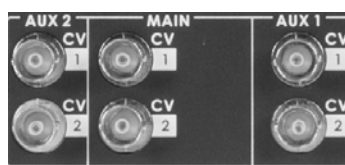

MAIN and AUX (BNC) Outputs

Two Composite (CV) outputs are provided for user defined AUX1 and AUX2 outputs. Two Composite (CV) BNC connectors are provided for MAIN / Program output.



Multi View Output

DVI-D digital signal preview output connector.
See pages 12 and 36 also.



GPI IN / OUT

The GPI socket can be used for simple external control.



RS-422 Remote

9-pin serial port standard RS-422 interface.



POWER

Switches the power On / Off.



DC IN

DC in socket connect the supplied 12V 2.5A PSU to this socket. The connection can be secured by screwing the outer fastening ring of the DC In plug to the socket.



Ground Terminal

If you are using other items with grounding terminals, connect them together using a cable with a cross-sectional area of at least 1.0 mm².



AUDIO OUT

Supports two XLR Balanced Audio outputs. Two RCA / Phono audio output are also provided. User can select mixed Mono or Stereo output via a switch.

For more information see page 31 onwards.



AUDIO IN

Allows connection of two RCA / Phono connectors at line level. There is also two XLR Balanced Audio Inputs. Switches related to these XLR inputs allow for Line or Mic level sources to be used as well as supplying 48V Phantom power.

For more information see page 31 onwards.



MONITOR HDMI INPUT

HDMI input – to Monitor only – **this input is not mixed.**



MONITOR FW UPGRADE

This connector is used by service personnel to apply firmware updates to the monitor.

Multi-Image Preview

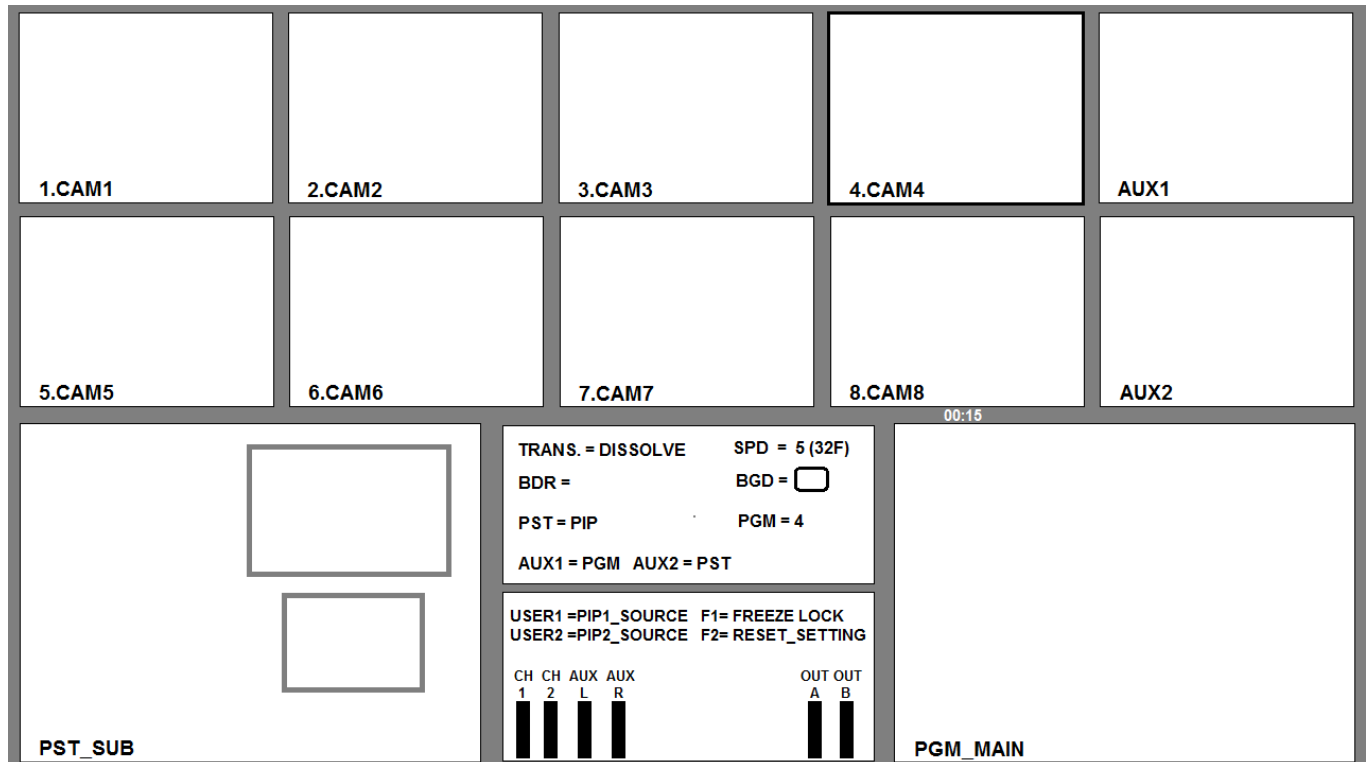

The HS-600 Multi-Image Preview is supplied from the DVI-D connection on the rear panel and also to the 17.3" monitor built into the case lid. When connected to a compatible DVI-D monitor the above multi-image layout is seen. Alternatively you could use a DVI-D to HDMI cable and take this into a HDMI monitor instead. Please note not all monitors are compatible, please double check with your chosen monitor beforehand. For optimal picture and colour performance use a Datavideo TLM-170H, HR or HM type monitor.

The first two rows of images on this Preview show the live sources 1~8 coming into the mixer and also the assigned auxiliary outputs AUX1, AUX2. Below these two rows of images are two larger images. One for the Preview (PST_SUB) and one for the Program (PGM_MAIN) outputs.

In between the PST and PGM images is the HS-600 Status Display and below it the Settings Display. When the Settings Menus are not in use you will see audio peak meters here instead as shown above.

The HS-600 Multi-Image Preview also supplies basic tally information by highlighting the live Program source with a red border, and the cued next source with a yellow border. If BG (background colour), PIP (Picture in Picture) or Luma Key are enabled then these red or yellow tally indicators may not be present. In these situations the Status Display in the centre of the Multi Image Preview will confirm what image is being sent to Preview (PST) and Program (PGM). In the above example input 4 is being sent to PGM and PST is being fed with a PIP image, so only image 4 is highlighted with a red border.

For more information on changing the Multi-Image Preview see page 36.

Keyboard Controls – Video Switching

Main Source and Sub Source Rows

The Main Source Row of buttons is the active channel, this is the Live output. The active channel will appear as the Program Output (PGM). You can switch or CUT from one source to another directly on the Main Source Row. You will see the PGM Output change as you press different keys along this row of buttons.

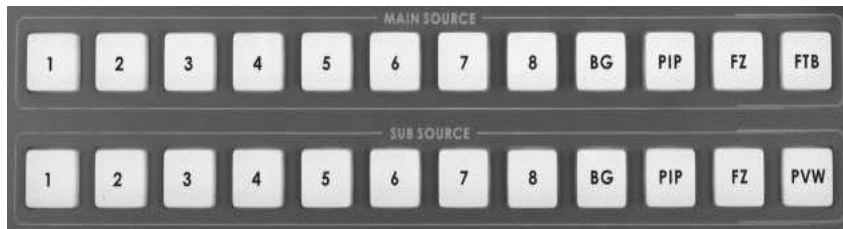

The Sub Source Row is the Cued channel; this channel will appear in the PST or Preview window. The Sub Source selection determines which input will be transitioned to when using any of the transition controls.

N.B. The keys on the Main and Sub Source Rails will be inactive while the T-Bar is active. Only when the T-Bar is fully up or fully down will the keys respond.

BG

Background – shows the background colour selected for use on the Main and Sub Source Rails.

PIP

Picture In Picture – Can be set up manually set to any chosen position within the video area. **See page 19.**

FZ

Freeze – The current PST or PGM image displayed is frozen until toggled off.

FTB

Fade To Black – This is on the Main Source Rail only. Pressing FTB will fade the PGM output to black. To fade back to video you need to press the FTB button again.

PVW

Preview – This is on the Sub Source Rail only. When you press the PVW Key you will see the active transition or effect previewed in the PST window of the Multi-Image display.



CUT

This performs a simple immediate switch from the current main source to the selected sub source. The selected transition wipe or dissolve is not used.

TAKE

This performs an automated switch from the current main source to the selected sub source. The selected transition wipe or dissolve will also be used. The timing of the transition is set by the chosen Speed/Level button.



T-Bar

This performs a manually controlled switch from the current main source to the selected sub source. The selected transition wipe or dissolve will also be used. When the T-Bar has travelled as far as it can go the transition between sources is complete. T-Bar will be indicated in the status display if the T-Bar is in use.

Keyboard Controls – Video Transitions

Transition Selection

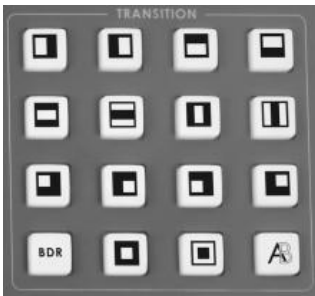

The HS-600 features 14 programmable wipe patterns and an A/B dissolve or fade.

All wipes can have an optional colour border applied, and can be set to one of five preset speeds.

The active transition, speed, border width and colour are confirmed in the Multi-Viewer Status Display.

Transitions can be performed manually by using the T-Bar or automatically using the TAKE button.



Vertical Wipe Left to Right



Horizontal Wipe Bottom to Top



Horizontal Wipes from Centre to Top and Bottom



Vertical Wipes from Centre to Left and Right sides



Corner Wipe from Top Left to Bottom Right



Corner Wipe from Bottom Left to Top Right



Box Wipe from Centre to outside edges



Vertical Wipe Right to Left



Horizontal Wipe Top to Bottom



Horizontal Wipes from Top and Bottom to Centre



Vertical Wipes from Left and Right sides to Centre



Corner Wipe from Bottom Right to Top Left



Corner Wipe from Top Right to Bottom Left



Box Wipe from outside edges to Centre



A/B Dissolve or fade



Add a border to certain effects such as Wipes. You can select between three border widths, N (Narrow), M (Medium) and W (Wide), simply by repeatedly pressing the BDR Key. The active width and colour is indicated in the Multi-Image Preview Status Display.



Speed / Level Selection

The user can choose one of five different speeds or levels for a transition effect. The timing value of each button can be programmed by the user in advance using the HS-600 Setting menu. **See page 19.**

Keyboard Controls – Video Effects



SETTING BUTTON

This button is used to enter the HS-600 configuration and settings menus. The menu options are displayed on the DVI-D based Multi-Image Preview output. Press the up, down, left, or right arrow buttons to navigate the menu choices or to change values. Use the ENTER button to confirm the current setting.

LOGO SETTING

PIP SETTING

LUMA KEY SETTING

These three buttons provide a short cut to the required menu set up which is then displayed on the Multi-Viewer output.

MOSAIC

Press the MOSAIC Key to activate the MOSAIC Effect.

The MOSAIC effect can be set to six different levels using the BDR Keys. You will see the effect change in the PST window.

PAINT

Press the PAINT Key to activate the Paint Effect.

The Paint effect can be set to six different levels using the BDR Keys. You will see the effect in the PST window.

B/W

Press the B/W Key to activate the black and white effect.

USER 1 / USER 2

Press the USER 1 Key to select PIP1 BG/PIP source.

Press the USER 2 Key to select PIP2 BG/PIP source.

BG CLR

You can select BG CLR if you want to display a background screen. The background can be set to one of eight different colours, colour bars or framing lines. The Multi-Viewer Status Display will indicate the active background. The background can be changed using the BG Colour Key.

BDR CLR

A wipe can be given a coloured edge or border. The border can be one of three widths, and one of eight colours.

The Border Width and Colour are indicated in the Multi-Image Status Display.

You can set the Border width by repeatedly pressing the BDR Key - The Status Display will show the following options:

BORDER =	No Border
BORDER = N "Color"	Narrow Border
BORDER = M "Color"	Medium Border
BORDER = W "Color"	Wide Border

You can set the Border Colour by repeatedly pressing the BDR CLR Key - The Status Display will show the following options in sequence:

BLACK - BLUE - RED - MAGENTA - GREEN - CYAN - YELLOW - WHITE

Keyboard Controls – Special Effects

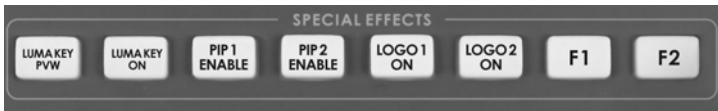

LUMA KEY PVW

When this button is engaged, the LUMA key function will display in the preview output (PST) window.

LUMA KEY ON

When this button is engaged, the LUMA key function will display on the program output (PGM) window.

PIP 1 ENABLE PIP 2 ENABLE

Step.1 – Press PIP in the Sub Source row of buttons.

Step.2 – Press PIP 1 ENABLE and PIP 1 is now shown in PST Preview.

Step.3 – Press PIP SETTING in EFFECTS and adjust the PIP settings in the Multi-Viewer Status Display area.

Step.4 – If PIP 2 is required press PIP 2 ENABLE and adjust (see Step.3).

Step.5 – When happy with PIP layout in PST Preview then transition to PGM using T-Bar, TAKE or CUT button.

LOGO 1 / 2 ON

When this button is engaged, the LOGO 1 / 2 will display on PGM.

F1

This button is lock frame. You can lock the video frame on the Main or Sub Source. If you want to freeze a new video frame, please press F1 button, unlock last frame picture.

F2

Item by item reset function.



AUX Source Selection

There are four Composite Auxiliary outputs on the rear of the HS-600. Two AUX1 outputs and two AUX2 outputs. It is possible to assign either a source input, background colour, Preview (PST) or Program (PGM) to these outputs.

To assign a video source input to the selected AUX channel.

Step.1 - Press AUX1 SEL or AUX2 SEL key – Key will flash.

Step.2 - Press the input source number that you want to assign.

Step.3 - Press same AUX SEL key to stop key flash and exit Aux Source setting.

Alternatively to make the AUX output a dedicated Preview (PST) output.

Step.1 - Press AUX1 SEL or AUX2 SEL key – Key will flash.

Step.2 - Press the SUB key to the right.

Step.3 - Press same AUX SEL key to stop key flash and exit Aux Source setting.

Or to make the AUX output a dedicated Program (PGM) output.

Step.1 - Press AUX1 SEL or AUX2 SEL key – Key will flash.

Step.2 - Press the MAIN key to the right.

Step.3 - Press same AUX SEL key to stop key flash and exit Aux Source setting.

Settings Menus

1: COUNT_DOWN_TIME
2: PIP
3: CG (LUMA KEY)
4: LOGO
5: VIDEO IN & OUT
6: AUDIO MIXER
7: MULTI. IMAGE
8: SYSTEM
9: STORE RECALL & UPDATE
10: RESET DVI_IN
ESCAPE

The HS-600 is set up by a series of menus. Once the initial settings have been chosen they are stored within the system, so it may be only necessary to make these changes once.

This section covers the **SETTINGS** Menus in the order that they appear on the HS-600 Multi-Image Preview. These settings may also appear in more detail elsewhere in this instruction manual.

When the **SETTINGS** button is pressed the Main Menu list, shown here, is displayed between the PST and PGM images on the DVI-D Multi-Image Preview output.

1: COUNT_DOWN_TIME

This menu option allows the user to set a countdown timer displayed in the Multi-image Preview. This function works with the TAKE button and allows the user to standardise how long to stay with a selected source before the TAKE button is pressed again. The value is set in minutes and seconds (MM:SS). Once the TAKE button is pressed the timer shown above the PGM image will count down to zero from the value set here. The countdown timer is for user reference only, nothing happens when the value reaches zero. Once the user presses the TAKE button again the counter will be reset to the chosen value and will immediately start counting down again.

- Press the **SETTING** button and then use the arrow buttons to highlight the **COUNT_DOWN_TIME** item.
- Press the **ENTER** button to confirm the selection.
- Use the arrow buttons to highlight the **COUNT_DOWN_TIME** value.
- Use the up or down arrow buttons to change the value (00:00~59:59).
- Press the **ENTER** button to confirm the value.
- Use the arrow buttons to highlight **ESCAPE** and press **ENTER**.

2: PIP

This menu option allows the user to set up the Picture In Picture (PIP) function before it goes live in the PST image of the Multi-image Preview. The user can decide which source will be the Larger PIP background image and which sources will be the smaller PIP_1 and PIP_2 images. The user can decide how big the PIP_1 and PIP_2 images will be and their position in front of the chosen background source. The user also has the ability to set a coloured border or edge to the smaller PIP_1 and PIP_2 images.

- Press the **SETTING** button and then use the arrow buttons to highlight the **PIP** item.
- Press the **ENTER** button to confirm the selection.
- You can also use the **PIP SETTING** short cut button to get to this menu quickly.

The PIP function is described in full from page 21.

3: CG (LUMA KEY)

This menu option allows the user to set up the Character Generator (CG) or LUMA KEY function before it goes live in the PST image of the Multi-image Preview. It is possible to use the input from a computer with CG-100 software to create a text or graphic overlay on top of the HS-600 PST or PGM video. It is also possible to use a video input as a keying source to create a pleasing or original video effect.

- Press the **SETTING** button and then use the arrow buttons to highlight the **CG (LUMA KEY)** item.
- Press the **ENTER** button to confirm the selection.
- You can also use the **LUMA KEY SETTING** short cut button to get to this menu quickly.

The CG (LUMA KEY) function is described in full from page 23.

4: LOGO

This menu option allows the user to set up the LOGO function before it goes live in the PGM image of the Multi-image Preview. A computer designed logo or station bug file can be saved to an SD card and loaded into the HS-600 memory. The Logo can then be assigned to one of two buttons and overlaid on top of the Program output. It is also possible to use the LOGO function like a second LUMA KEY feature and use a video source input as the LOGO key source.

- Press the **SETTING** button and then use the arrow buttons to highlight the **LOGO** item.
- Press the **ENTER** button to confirm the selection.
- You can also use the **LOGO SETTING** short cut button to get to this menu quickly.

The LOGO function is described in full from page 25.

5: VIDEO IN & OUT

This menu option allows the user to change the settings of video coming into or going out of the HS-600.

- Press the **SETTING** button and then use the arrow buttons to highlight the **VIDEO IN & OUT** item.
- Press the **ENTER** button to confirm the selection.
- You are presented with four choices.

The video INPUT adjustment function is described from page 28.

The video OUTPUT choices are described from page 29.

How to ASSIGN VIDEO SOURCES is described on page 30.

How to adjust the setting of the HS-600 optional DV and SDI board is described on page 40.

6: AUDIO MIXER

This menu option allows the user to change the settings of audio coming into or going out of the HS-600. The user can choose to delay the audio by up to 18 frames. The user also has the ability to decide which audio channels will be used in the SDI output if the optional DV and SDI card is fitted to the mixer.

- Press the **SETTING** button and then use the arrow buttons to highlight the **AUDIO MIXER** item.
- Press the **ENTER** button to confirm the selection.

The AUDIO MIXER function is described in full from page 33.

7: MULTI. IMAGE

This menu option allows the user to set up the Multi-Image Preview including renaming the legends on each input image 1~8.

- Press the **SETTING** button and then use the arrow buttons to highlight the **MULTI. IMAGE** item
- Press the **ENTER** to confirm the selection.

Adjusting the MULTI. IMAGE preview is described in full from page 36.

8: SYSTEM

This menu option allows the user to set up the SPEED KEYS for transition duration values, Keyboard backlight brightness and define the use of GPI/O port on the rear of the mixer.

- Press the **SETTING** button and then use the arrow buttons to highlight the **SYSTEM** item
- Press the **ENTER** to confirm the setting
- **GPI SETTING** – See **page 37** for more information
- **SPEED KEY SETTING** - adjustment range from 2 to 90 Frames
- **SWITCH BRIGHTNESS** - adjust keyboard back light brightness

9: STORE RECALL & UPDATE

- Press the **SETTING** button and then use the arrow buttons to highlight the **SYSTEM** item
- Press the **ENTER** to confirm the setting

The STORE RECALL & UPDATE function is described in full from page 38.

10: RESET DVI_IN

- Press the **SETTING** button and then use the arrow buttons to highlight the **RESET DVI_IN** item
- Press the key ◀ or ▶ can reset DVI_1 IN or DVI_2 IN

HS-600 Video Layers

The HS-600 is a Standard Definition Digital Video Switcher and as well as mixing video and audio sources it has additional functions such as Picture In Picture (PIP), CG LUMA KEY and LOGO.

Before attempting to use the HS-600 PIP, CG LUMA KEY and LOGO functions it may help to first understand the order of the video layers at the HS-600 Program (PGM) outputs.

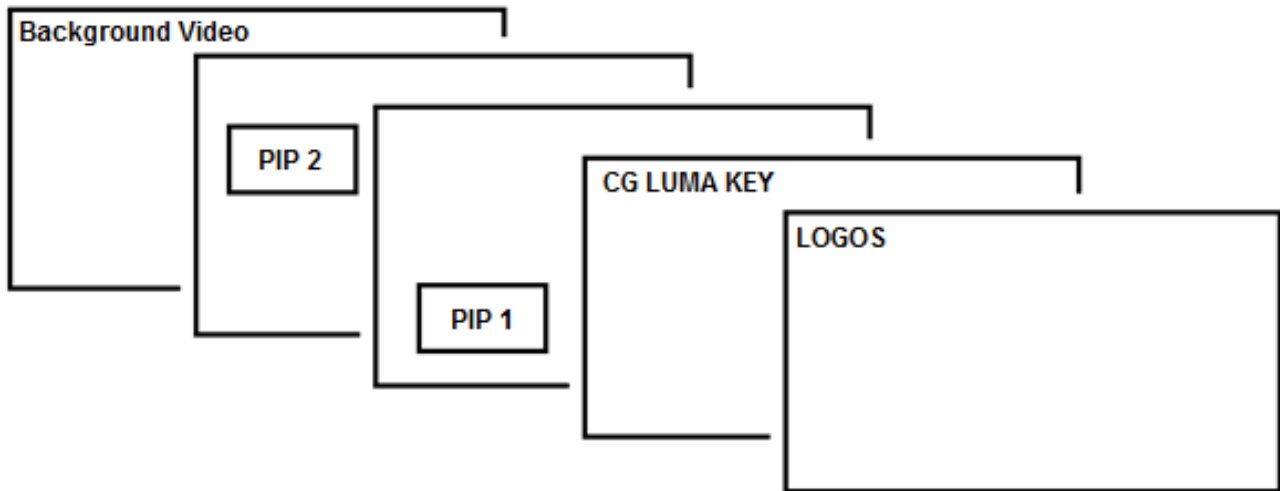

The **Background video layer** is the normal video layer when mixing and switching with the HS-600. It occupies the whole screen area of the Program output. This layer can be hidden or part hidden by the PIP, LUMA KEY and LOGO layers in front of it.

The **PIP 2 layer** does not occupy the whole screen and is shown in front of the Background video layer when enabled. In some setups the PIP 2 image can be hidden behind the PIP 1 image. This is not a fault. Change the position or size of the PIP 1 or PIP 2 image if required.

The **PIP 1 layer** does not occupy the whole screen and is shown in front of the Background video and PIP 2 layers when enabled. In some setups the PIP 1 image can hide the PIP 2 image. Change the position or size of the PIP 1 or PIP 2 image if required.

The **CG LUMA KEY layer** can occupy the whole screen. If set up incorrectly this layer can stop the video layers behind it from being seen properly. Re-adjust your CG LUMA KEY settings or switch off the CG LUMA KEY function on the HS-600 to restore the video behind it.

The **LOGO layer** does not occupy the whole screen and all other layers are visible through it. A logo if positioned incorrectly can partially hide an important part of the video, PIP or CG LUMA KEY layers. Typically logos or station ID bugs are placed in a corner of the screen.

NB: Logos need to be prepared and positioned in advance of the live production starting as they only appear on the program output.

Most broadcast networks have guidelines and advice on the use of video, images, music, logos and on screen text so it is best to check beforehand when planning a production. Do not use copyright protected content until you have the relevant permissions. Information on royalty free video, images and music is widely available. Speak to your local dealer or search for advice on the internet.

PIP – Picture In Picture function

The HS-600 Picture in Picture function allows you to place one or two smaller PIP images over a chosen full size background image. The smaller PIP images can be set to one of two predefined sizes and positioned almost anywhere within the Preview/Program screen area. The PIP windows can also have a coloured border applied, and can be brought into the production with a chosen wipe, cut or dissolve transition.

PIP Setting

Before trying to activate the PIP function it is best to understand how to set up or choose the right options for your production. Press the **PIP SETTING Key** in the **EFFECTS** area of the HS-600 keyboard. This is a short cut key that allows you to get to the PIP menu settings quickly. When this key is pressed you will see a PIP SETTING Menu appear in the Multi-Image Preview between the PST and PGM images. The PIP options provided here are:

```
[PIP SETTING]
1. PIP_1 source : CH_1
2.      size      : BIG
3.      border    : M , GREEN
4.      position  : X=158, Y=098
5. PIP_2 source  : CH_2
6.      size      : SMALL
7.      border    : M , CYAN
8.      position  : X=158, Y=158
9. PIP background : CH_3
      ESCAPE
```

Choose your PIP sources

Using the four arrow keys in the EFFECTS area of HS-600 keyboard highlight the relevant PIP SETTING menu option and press the ENTER key to select it. The arrow keys will then allow you to change the highlighted the value of the selected option. Press the ENTER key to store your chosen value.

You can choose any of the live video sources from inputs 1 to 8 or the currently defined BG (Background Colour) source.

In our example above we have chosen to have two PIP images over our background image:

PIP_1 source is set as CH_1 **PIP_2 source** is set as CH_2 **PIP background** is CH_3

Setting the size of each PIP Image

Using the four arrow keys and the ENTER key navigate to and change options 2 and 6.

PIP sizes available are BIG or SMALL. It is not possible to define any other size of PIP image / window.

Setting the Position

Using the four arrow keys and the ENTER key navigate to and change options 4 and 8.

When the X and Y values are highlighted the up and down arrow keys change the value of the Y position and left and right arrow keys change the value of the X position.

Setting the Border

To help the PIP window stand out you can add a coloured border. The border can be set to one of three widths, and you also have a choice of eight colours. The PIP Border Width and Colour are indicated in options 3 and 7.

In our example above - M , GREEN means a Green, Medium width border.

You can set the PIP Border Width by using the **up** and **down arrow keys**.

N= Narrow, **M**=Medium, **W**=Wide and **no values displayed** means the PIP border option is currently turned off.

You can set the PIP Border Colour by using the **left** and **right arrow keys**.

BLACK - BLUE - RED - MAGENTA - GREEN - CYAN - YELLOW - WHITE

Preparing the PIP output in the PST_SUB Window

When preparing the PIP display output you will want to see it in the Multi-Image Preview PST_SUB output. To achieve this you need to press the PIP button on the lower Sub Source row of buttons first.

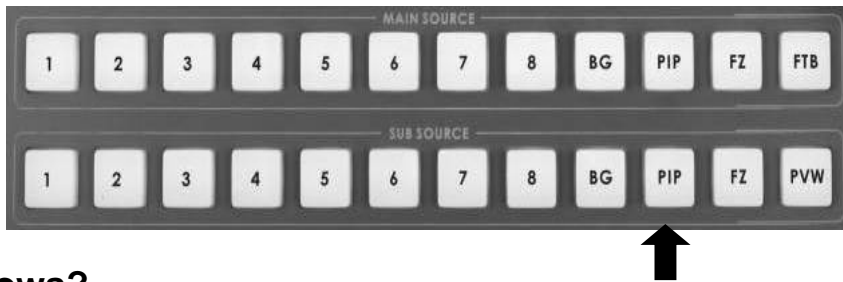

No PIP Windows?

If you can only see your chosen background image but no smaller PIP windows in the PST_SUB image then you need to activate one or both PIP windows.

To display PIP_1 on top of your chosen background video **press the PIP 1 ENABLE button** to toggle it ON or OFF.

To display PIP_2 on top of your chosen background video **press the PIP 2 ENABLE button** to toggle it ON or OFF.

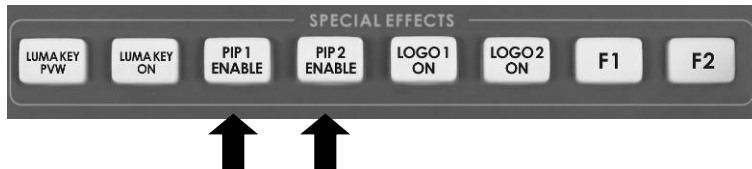

You now need to decide if you are happy with the position and size of PIP_1 or PIP_2 windows. You may also decide to only use one smaller PIP window instead of two.

Sending the prepared PIP to the Program output

In our example we have prepared the Picture In Picture images in the Multi-Image Preview PST_SUB window so that we know what it looks like and we know that we are now happy with the layout. We now want to use this in our production on the Program PGM_MAIN output. To do this we can use a simple dissolve or wipe transition with the T-Bar or Take button. Alternatively we could do a straight switch with the CUT button.



CG (LUMA KEY) function

The HS-600 has the ability to LUMA KEY. This means it is able to take a key source video input, either Composite or DVI, and replace the white or black parts of this image with the video from another source.

It is also possible with the HS-600 to keep the pure white and black parts of the key source image and only key video using the greyscale part in between pure white and black.

If the key source image only needs to be partially transparent, maybe to create a video watermark effect, then this can be set up quite easily too.

It is also possible to define a Window Matte using X and Y screen co-ordinates. The part of the key source image occupying this defined matte area is then keyed out to show the selected video source behind it.

Luma Key Setting

Before trying to activate the LUMA KEY function its best to understand how to set up or choose the right options for your set up well in advance of the production.

Press the LUMA KEY SETTING Key in the EFFECTS area of the HS-600 keyboard. This is a short cut key that allows you to get to the Luma Key menu settings quickly. When this key is pressed you will see a LUMA KEY SETTING Menu appear in the Multi-Image Preview in-between the PST and PGM images. The LUMA KEY options provided here are:

```
[LUMA KEY SETTING]
1: SOURCE           = CH 8
2: KEY LEVEL MAX.   = 240 (OFF WHITE )
3: KEY LEVEL MIN.   = 20 (OFF BLACK )
4: TRANSPARENT PT. = 20 W [ ] ████... B
5: TRANSPARENCY     = 0
6: WINDOW LEFT_TOP  = X=000 , Y=000
7: WINDOW RIGHT_BOTTOM = X=720 , Y=576
  ESCAPE
```

Choose your LUMA KEY sources

The **Background video** shown behind or through the KEY SOURCE image is the currently chosen input on the MAIN SOURCE row of buttons. This background video can be any source selected between CH1 and BG.



The **LUMA KEY source** is chosen using option 1: **SOURCE** as shown in the LUMA KEY SETTING menu above. This is the chosen image that will be affected by the other luma key options within the LUMA KEY menu.

KEY level and Transparency

Option 2 : **KEY LEVEL MAX** - sets the upper parameter for the key.

Option 3 : **KEY LEVEL MIN** - This sets the lower parameter for the key.

The range between the MAX and MIN values determines how many mid tone (greyscale) colours are keyed. The smaller the range the fewer the colours keyed out.

Typical settings for an overlay where you only want to remove a black background would be:

Key Level Max = 50 Key Level Min = 0

5. TRANSPARENCY - This sets the transparency level of the remaining overlay. Zero (0) being solid overlay and a higher number making the overlay less solid so the video behind shows through.

Setting up a Luma Key overlay with PowerPoint

The HS-600 has 8 inputs. Inputs 7 & 8 are DVI and these can be used to connect a DVI-D cable from a computer. The computer graphics card will need 2 output connectors, one for the PC monitor and one DVI connection to go to input 7 or 8 on the HS-600.

The PC will need to have *Microsoft Office* installed in order for *PowerPoint* to be used. If all the settings are correct on the mixer and the PC then we can attempt to use this computer display output to create a simple text overlay using the HS-600's Luma Key function.

1. Connect a DVI-D cable between the HS-600 input 8 and the spare DVI port on the PC's graphics card.
2. Turn on the HS-600 and then the PC.
3. Create a *PowerPoint* presentation with White text on a Black background. You may want to create your own **Slide Master** within *PowerPoint*. **Use the PowerPoint Help function for advice on how to do this.**
4. Select CH8 of the HS-600 so the PC output is shown in the Multi-Image Preview window. Can you see the PC output in the CH8 or PREVIEW PST_SUB window?
5. If you cannot see the computer output then extend the PC's desktop within Windows to monitor 2 as below.

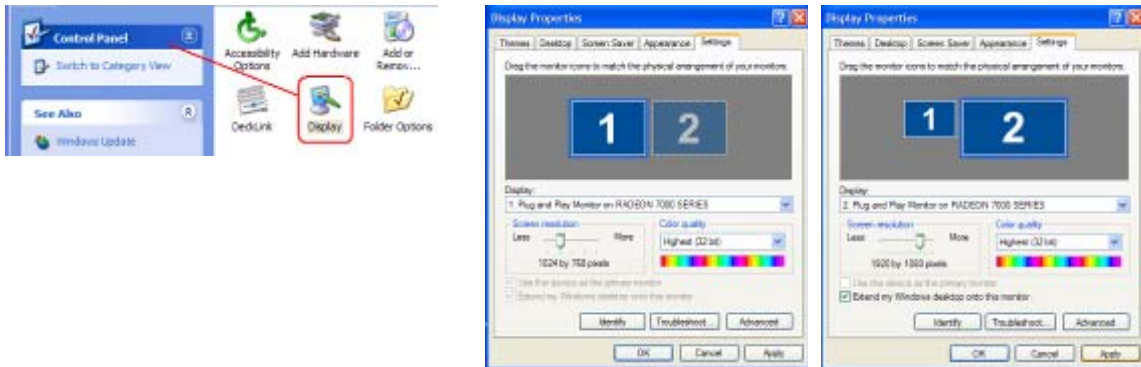

6. PC screen size for monitor 2 should match 1280x1024 or 1024x768.
7. If HS-600 input 8 is just a blue screen (blue desktop background only), then try using the PC mouse pointer to drag a window or a desktop icon across and onto the HS-600 input 8 window.
8. OK, so you should now have the Monitor 2 PC display running into input 8 on the HS-600.
9. Open up *Powerpoint* on the PC and use *Set Up Show* so that the presentations play back on Monitor 2 (the HS-600) and the presenter's output is sent to Monitor 1 (the PC's own monitor).

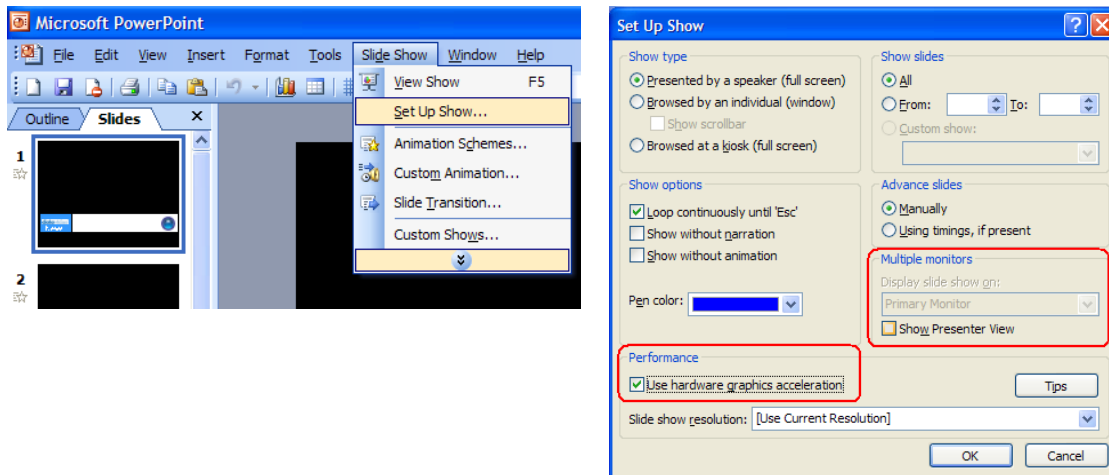

10. Ensure CH8 is selected on the HS-600 Luma Key Settings menu and a different video input is chosen on the Main Source row of buttons.
11. Press the LUMA KEY PVW button in the SPECIAL EFFECTS area of the HS-600 keyboard.
12. Now you should see the presentation playing back in the PREVIEW PST_SUB window. We can now attempt to key out the Black parts of the Presentation using the **LUMA KEY SETTING** in the HS-600's System Configuration menu whilst the **LUMA PVW** button is also ON.
13. Once you have the right LUMA SETTING or overlay effect in the PREVIEW window you can then press **LUMA PGM** key to toggle the overlay effect ON or OFF the main PROGRAM output.

How to set up a Window Matte for Luma Keying

Press the LUMA KEY SETTING Key in the EFFECTS area of the HS-600 keyboard. This is a short cut key that allows you to get to the Luma Key menu settings quickly. When this key is pressed you will see a LUMA KEY SETTING Menu appear in the Multi-Image Preview in-between the PST_SUB and PGM_MAIN images.

The LUMA KEY options provided here are:

```
[LUMA KEY SETTING]
1: SOURCE           = CH_8
2: KEY LEVEL MAX.   = 240 (OFF WHITE )
3: KEY LEVEL MIN.   = 20 (OFF BLACK )
4: TRANSPARENT PT. = 20 W [ ■■■■■■■■ ] B
5: TRANSPARENCY     = 0
6: WINDOW LEFT_TOP  = X=000 , Y=000
7: WINDOW RIGHT_BOTTOM = X=720 , Y=576
  ESCAPE
```

It is possible to define a Window Matte area using X and Y screen co-ordinates. The X and Y values (options 6 and 7 above) define a box area by setting a top left corner position and a bottom right corner position. The part of the key source image outside this defined matte box area is then keyed out to show the selected video MAIN source behind it.

LOGO function Overview

The HS-600 can display one or two logos in any location on the screen. If you want a larger logo it is possible to create two halves and combine them on the screen. The logos when activated will only show in the PGM_MAIN window or on Program outputs so you need to plan, prepare and set up the logos well in advance of the start of the production.

The Logo function can also be used as a second Luma Key overlay, from any one of the eight input channels. For example you could take an output from a PC or Laptop via DVI, and key out the background to create a text or graphic overlay as described in the Luma Key section.

The Logos are transferred to the HS-600 on an SD Card, which is inserted into the SD card slot on the left hand edge of the HS-600 keyboard. See page 9, Keyboard Overview, Item 8.

The logos need to be .bmp format and no larger or smaller than **128 x 96 pixels, RGB, 888**
For the HS-600 to recognise the logos they **must be** called **logo1.bmp** and **logo2.bmp**

The logos are positioned on the screen using X axis and Y axis settings. Y axis is the position top to bottom and X axis left to right.

The two sample logos are:



How to replace the sample Logos

You can replace the supplied Datavideo example logos with logos of your own design using an SD card.

The Datavideo sample logos are designed to butt together and form one large logo. You can use two completely separate logos, each **128 x 96 pixels**, or if you need a larger logo, split the image in two as shown on the previous page.

For the HS-600 to recognise the logos **they must be called logo1.bmp and logo2.bmp**. The Logos are transferred to the HS-600 on an SD Card. This is inserted into the SD card slot on the left hand edge of the HS-600 keyboard. See page 9, Keyboard Overview, Item 8.

Press the LOGO SETTING button in the EFFECTS area of the HS-600 keyboard so that it becomes active. The menu options will be displayed on the Multi-Image Preview between the PST_SUB and PGM_MAIN images.

The LOGO 1 SETTING options provided here are:

```
[LOGO 1 SETTING (LUMA KEY) ]
1: SOURCE          = LOGO FILE
2: LOGO POSITION    = X= 10 , Y= 7
3: KEY LEVEL MAX. = 240 (OFF WHITE )
4: KEY LEVEL MAX. = 20 (OFF BLACK )
5: TRANSPARENT PT. = 20 W [ ████████ ] B
6: TRANSPARENCY   = 0
7: WINDOW LEFT_TOP      = X=000 , Y=000
8: WINDOW RIGHT_BOTTOM = X=720 , Y=576
9: COPY LOGO FILE. = LOGO_1
  ESCAPE
```

Using the arrow keys in the EFFECTS area of the HS-600 keyboard highlight LOGO_1 in option 9. The menu will then display the copy option as shown below.

```
[LOGO 1 SETTING (LUMA KEY) ]
1: SOURCE          = LOGO FILE
2: LOGO POSITION    = X= 10 , Y= 7
3: KEY LEVEL MAX. = 240 (OFF WHITE )
4: KEY LEVEL MAX. = 20 (OFF BLACK )
5: TRANSPARENT PT. = 20 W [ ████████ ] B
6: TRANSPARENCY   = 0
7: WINDOW LEFT_TOP      = X=000 , Y=000
8: WINDOW RIGHT_BOTTOM = X=720 , Y=576
9: COPY LOGO FILE. = LOGO_1
  ESCAPE
  Press '▼' key 2 SEC = Start to copy.
```

Pressing the down arrow key for two seconds starts the copy process. Your logo1.bmp file on the SD card will be read and copied into the logo1 memory of the HS-600. Once the process is complete it will return the menu display back to the normal options.

The same process can be applied to logo2. You will have to ESCAPE the LOGO 1 SETTING first and then choose option 4 : LOGO from the initial SETTINGS menu before you can see the choice for LOGO 2 SETTING.

Setting up a Logo

It is best to prepare the LOGO set up before your production starts. The logos when activated will only show in the PGM_MAIN window or on Program outputs so you need to plan, prepare and set up the logos well in advance.

Press the LOGO SETTING button, so that it becomes active. The LOGO1 Settings menu will be displayed. If you need LOGO2 options you will have to ESCAPE the LOGO 1 SETTING first and then choose option 4 : LOGO from the initial SETTINGS menu before you can see the choice for LOGO 2 SETTING.

The LOGO 1 SETTING options provided here are:

```
[LOGO 1 SETTING (LUMA KEY) ]
1: SOURCE           = LOGO FILE
2: LOGO POSITION     = X= 10 , Y= 7
3: KEY LEVEL MAX.  = 240 (OFF WHITE )
4: KEY LEVEL MAX.  = 20 (OFF BLACK )
5: TRANSPARENT PT. = 20 W [ ■■■■■■■■ ] B
6: TRANSPARENCY    = 0
7: WINDOW LEFT_TOP = X=000 , Y=000
8: WINDOW RIGHT_BOTTOM = X=720 , Y=576
9: COPY LOGO FILE. = LOGO_1
  ESCAPE
```

To use the LOGO1 bmp image set option 1 : SOURCE to LOGO FILE.

Then to display LOGO1 on the PGM_MAIN window press the LOGO1 ON button in the SPECIAL EFFECTS area of the HS-600 keyboard.

You will see the LOGO on the screen, use option 2 : LOGO POSITION to move the logo to where you need it. POSITION Y sets the vertical position (up/down) and POSITION X sets the horizontal position (left/right).

Luma Keying with the Logo Function

With the HS-600 it is possible to Luma Key in two ways, either with the CG (LUMA KEY) function or with the Logo function.

The benefit of using the Logo function for Luma keying is that you can have two overlays running at the same time over the same video background. One overlay could be used for a lower third text banner and the other for guest or programme titles.

In the Logo Function menu (above) set option 1 : SOURCE to the channel that you want to key. You can select any channel 1 ~ 8 however it would normally be a DVI channel for an overlay from a computer but the choice is yours.

The Luma key settings within the LOGO function are used in the same way as described within the CG (LUMA KEY) section of this manual. Do not forget to press the LOGO1 ON button in the SPECIAL EFFECTS area of the HS-600 keyboard first!

DSK - Down Stream Keying - CG (Graphic Overlay)

With Luma Keying the HS-600 does the keying within the mixer, thus removing the black background from the CG or Key Source. Alternatively the Luma key levels can also be set to remove white levels according to the overlay or source you are working with.

However, External DSK or Down Stream Key is also possible with the HS-600. The main reason why you may want to use a DSK is to be able to provide both a clean mix of video (without any overlay) and at the same time to also provide the same mix of video with a CG or DSK overlay. This DSK overlay would be provided by another piece of equipment, typically a computer, which would need to be purchased separately.

Please speak to your dealer for further advice on creating an HS-600 DSK set up using a CG-100 PC.

Video Input Adjustment

It is possible to adjust the Composite or DVI video signals within the Datavideo HS-600 switcher. However, it is always better to try to produce the best video signal possible from the input equipment first.

For example, if the connected video equipment is a live camera then it should be possible to white balance the camera and reset its exposure level after any stage lighting has been set up. The camera's manual should explain how to do this properly. This should ensure that the camera is feeding good pictures to the mixer. It should be very rare that video input should still need adjusting within the HS-600, especially if the camera and lighting have already been set up correctly.

For the same reasons any pre-recorded, or B Roll, video should be reviewed before being used in the production.

```
1: COUNT_DOWN_TIME
2: PIP
3: CG (LUMA KEY)
4: LOGO
5: VIDEO IN & OUT
6: AUDIO MIXER
7: MULTI. IMAGE
8: SYSTEM
9: STORE RECALL & UPDATE
10: RESET DVI_IN
    ESCAPE
```

The HS-600 is set up by a series of menus. Once the initial settings have been chosen they are stored within the system, so it may only be necessary to make these changes once.

When the **SETTING** button is pressed in the **EFFECTS** area of the HS-600 keyboard the Main Menu list, shown left, is displayed between the PST and PGM images on the Multi-Image Preview output.

This menu option allows the user to change settings which effect video coming into or going out of the HS-600. Use the arrow buttons to highlight the **VIDEO IN & OUT** item then press the **ENTER** button to confirm the selection.

[IN / OUT SELECT]

```
1: INPUT
2: OUTPUT
3: FRAME STORE
4: ASSIGN VIDEO SOURCES
5: DV & SDI_OUT
    ESCAPE
```

```
VIDEO CH.   : IN_1
1: INPUT TYPE   = CV
2: BRIGHTNESS  = +00
3: CONTRAST    = +00
4: SATURATION   = +00
5: RGB CORRECTION : X_+00 Y_+00
6: AGC         = ON
7: 7.5IRE      = NC
    ESCAPE
```

For Composite CV inputs 1 to 6 the options will be as follows.

This value will change according to your input choice above.

Brightness can be adjusted up or down [range -99 to +99]

Contrast can be adjusted up or down [range -99 to +99]

Saturation can be adjusted up or down [range -99 to +99]

RGB Correction X and Y can be adjusted [range -37 to +36]

Automatic Gain Control is only used with Composite CV inputs

Used on NTSC models only – Sets IRE (black level) to 0 or 7.5.

```
VIDEO CH.   : IN_8
1: INPUT TYPE   = DVI_D
2: BRIGHTNESS  = +00
3: CONTRAST    = +00
4: SATURATION   = +00
5: RGB CORRECTION : X_+00 Y_+00
6: ___
7: ___
8: DVI INPUT MODE = 1024x768 , 60Hz
9: DVI DISP. SIZE = 100%
    ESCAPE
```

For DVI inputs 7 and 8 the options will be as follows.

This value can be changed on input 8 only to DVI_A or DVI_D.

Brightness can be adjusted up or down [range -99 to +99]

Contrast can be adjusted up or down [range -99 to +99]

Saturation can be adjusted up or down [range -99 to +99]

RGB Correction X and Y can be adjusted [range -37 to +36]

← These settings cannot be changed.

MAIN Video Outputs

The HS-600 has a number of video outputs. The video outputs labelled MAIN are two Composite (CV) BNC connectors on the HS-600 rear panel.

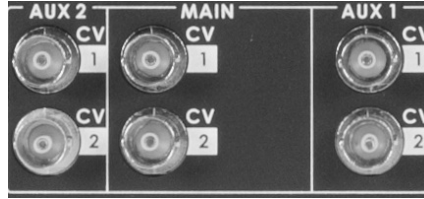

These outputs should remain set in the menu as two Composite (CV) outputs and a single Y/C output.

The Y/C connection is not present externally as it is used internally to feed the built in monitor panel with Program output. If the monitor panel program output stops working use the menus below to ensure it is correctly set.

- 1: COUNT_DOWN_TIME
- 2: PIP
- 3: CG (LUMA KEY)
- 4: LOGO
- 5: VIDEO IN & OUT**
- 6: AUDIO MIXER
- 7: MULTI. IMAGE
- 8: SYSTEM
- 9: STORE RECALL & UPDATE
- 10: RESET DVI_IN
- ESCAPE

The HS-600 is set up by a series of menus. Once the initial settings have been chosen they are stored within the system, so it may only be necessary to make these changes once.

When the **SETTING** button is pressed in the **EFFECTS** area of the HS-600 keyboard the Main Menu list, shown left, is displayed between the PST and PGM images on the Multi-Image Preview output.

This menu option allows the user to change settings which effect video coming into or going out of the HS-600. Use the arrow buttons to highlight the **VIDEO IN & OUT** item then press the **ENTER** button to confirm the selection.

[IN / OUT SELECT]

- 1: INPUT
- 2: OUTPUT**
- 3: ASSIGN VIDEO SOURCES
- 4: DV & SDI
- ESCAPE

[VIDEO OUTPUT SETTING] (PAL)

- 1: OUTPUT MODE = CV*2 + Y/C**
- 2: ASPECT RATIO = 4 : 3
- 3: V_OUT 7.5 IRE = OFF (NTSC_ONLY)
- ESCAPE

This text confirms if the mixer is a PAL or NTSC unit.

Use the up or down arrows to select the required outputs shown. Aspect Ratio can be set to 16:9 or 4:3 depending on your inputs. Used on NTSC models only – IRE (black level) can be 0 or 7.5.

How to assign Main and Sub source buttons

The video inputs on the rear of the HS-600 are numbered 1 to 8. The first six are Composite (BNC) connectors and inputs 7 and 8 are DVI inputs.

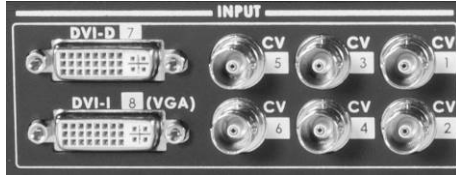

If we are using all of the video inputs then this numbering scheme works well and matches the default video assignments of the Main Source and Sub-Source rows of buttons on HS-600 keyboard.

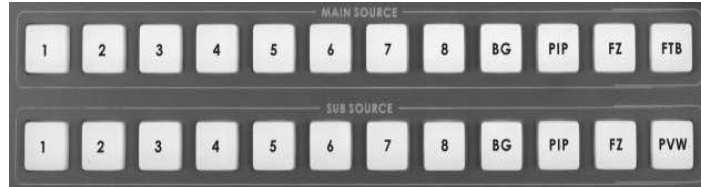

However, If we are only using the first four Composite inputs and one DVI input then switching becomes confusing. We want to avoid choosing the wrong buttons (5, 6 and 8) that have no video supplied to them. So re-assigning the video sources that we are using to the first five buttons of the Main and Sub Source rows can make switching easy. It can also make us less likely to press a wrong button that will result in no video or 'dead air'.

- 1: COUNT_DOWN_TIME
- 2: PIP
- 3: CG (LUMA KEY)
- 4: LOGO
- 5: VIDEO IN & OUT**
- 6: AUDIO MIXER
- 7: MULTI. IMAGE
- 8: SYSTEM
- 9: STORE RECALL & UPDATE
- 10: RESET DVI_IN
- ESCAPE

The HS-600 is set up by a series of menus. Once the initial settings have been chosen they are stored within the system, so it may only be necessary to make these changes once.

When the **SETTING** button is pressed in the **EFFECTS** area of the HS-600 keyboard the Main Menu list, shown left, is displayed between the PST and PGM images on the Multi-Image Preview output.

This menu option allows the user to change settings which effect video coming into or going out of the HS-600. Use the arrow buttons to highlight the **VIDEO IN & OUT** item then press the **ENTER** button to confirm the selection.

- [IN / OUT SELECT]
- 1: INPUT
- 2: OUTPUT
- 3: ASSIGN VIDEO SOURCES**
- 4: DV & SDI
- ESCAPE

- [ASSIGN VIDEO SOURCES]
- 1: MAIN/SUB_1 = INPUT_1
- 2: MAIN/SUB_2 = INPUT_2
- 3: MAIN/SUB_3 = INPUT_3
- 4: MAIN/SUB_4 = INPUT_4
- 5: MAIN/SUB_5 = **INPUT_7**
- 6: MAIN/SUB_6 = **INPUT_7**
- 7: MAIN/SUB_7 = **INPUT_7**
- 8: MAIN/SUB_8 = **INPUT_7**
- ESCAPE

MAIN/SUB_1 relates to button 1 on the MAIN or SUB source row of the HS-600 keyboard, MAIN/SUB_2 relates to button 2 ...etc

So using our example of five sources (above) we only need to assign the DVI (Input 7) to button 5 and the first five buttons now relate to our sources. This changes the Multi-Image Preview also.

We can go a step further and also assign input 7 to buttons 6, 7 and 8 too. This so if we accidently hit them we will still mix video of some kind rather than supply no video at all.

NOTE: Care must be taken with this feature to avoid losing pictures from a connected video input too.

AUDIO MIXER function

Overview

The HS-600 has a simple, cost effective, four channel analogue audio mixer built in. The HS-600 has the ability to take audio from several types of analogue audio sources.

To achieve a good audio mix for recording or transmission it helps to understand which audio connections and settings are best suited to a particular type of audio source. In fact, it may even help prevent damage to your equipment, your hearing and even protect the audio circuits of the HS-600. So if you are new to audio mixing this information should be very useful.

The audio is fed into the mixer on the rear panel using the connections as shown below.

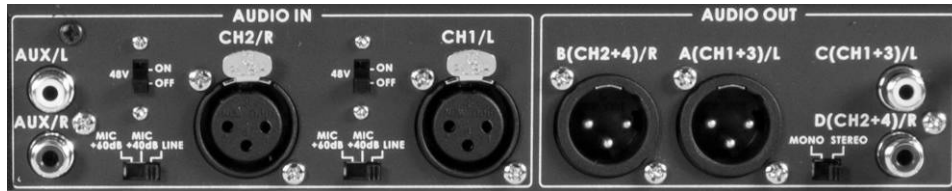

Line level and Mic level

Audio signals are fed into the HS-600's audio mixer on standard analogue audio cabling and connections. Depending on the audio source, cable type and settings used these audio source signals can be received by the HS-600 at different levels, typically Line level or Mic (microphone) level. This could be an issue because audio signals which are either too low or too high can ruin an otherwise professional video production or recording.

The main cause of different audio levels being input is usually the source equipment being used. A microphone, a CD player, a musical instrument, a DVD player and even a P.A. system can all supply different default audio signal levels. So knowing which sources supply stronger or weaker audio signals can help you avoid problems.

Typically the industry uses the **Decibel**, noted as two letters **dB**, to describe or measure the audio signal level being supplied by any piece of audio equipment or instrument. Depending on the type of equipment being used the letters dB may also be followed by a further letter indicating which scale or method of measurement was used to rate the signal. Yes, to confuse matters audio levels can be rated or defined using different methods. Luckily, there is an easy way to decide which items of kit should supply the lowest and highest signal levels.

Microphones - Typically supply the lowest audio signal levels, especially if they are non-powered microphones. There are exceptions to this but as a general rule most microphones will have to be pre-amplified to a higher signal level before their audio can be mixed alongside other audio sources. The HS-600 has two mic pre-amp circuits.

Musical Instruments – Such as keyboards and guitars supply higher than microphone signal levels but may still need to be pre-amplified correctly before their audio can be mixed alongside other audio sources. Audio cabling used incorrectly can also affect the 'sound envelope' of an instrument but we will not go into that here!

Equipment with RCA or Phono Connectors – Such as CD players and DVD players will supply audio at an industry agreed 'default' line level as there is usually no way to adjust the audio signal level going out of the equipment. Typically this 'Line level' audio is considered to be for delivery to other consumer type equipment such as a television set or Hi-Fi equipment, which will then control the audio heard at any attached speakers. As such this line level (-10dB) is usually much higher than a microphone level and slightly higher than a musical instrument signal level.

Equipment with balanced XLR 3 pin connectors – Such as professional audio mixers, recorders, players and amplifiers will supply audio at an industry agreed line level too. The main difference here is the professional line level can be as much as 30dB higher than the consumer rated RCA type line level connection from say a DVD player. That can be very loud and even ear damaging if you are not careful.

SAFETY FIRST: Always connect any audio connections with the equipment powered off and set the audio mixer faders or any headset volume knobs to minimum. Then turn on the equipment before slowly raising the audio faders or headset volume to a desired comfortable level.

Not all Microphones are the same

The HS-600 can support a variety of microphone types; here we will discuss the types supported and how to connect them.

Firstly, not all microphones are the same. They are all designed with different sensitivities, uses and mic circuits. For most video applications a *cardoid*, *super cardoid* or *hyper cardoid* microphone will be used. However, connect the wrong microphone and you will either end up with no audio, bad audio or a damaged audio circuit. So it helps to understand the line and mic switches associated with the balanced XLR audio inputs on the rear of the HS-600 mixer.

Line and Mic Switch

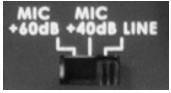

These switches have three settings which are **Line**, **mic +40** and **mic +60**. This is because there can be as much as a 40dB difference between the lower Mic Level and the higher Line Level that we may be trying to reach. Why is this? Well essentially it is because of the circuit involved. A microphone (mic) circuit produces a very small voltage based on air pressure waves (sounds) hitting a diaphragm which in turn moves a coil in close proximity to a magnet. The voltage sine wave produced by the coil in this simple *dynamic mic* circuit is not strong enough on its own to be useful for driving speakers or even registering in an audio mixer. So we use extra circuits, which are powered, to amplify or raise this signal from the mic level to the desired level where it is then useful for mixing, recording or driving speakers. This is the reason for the +40 and +60 mic positions of the switch. The +40 mic setting adds roughly 40dB to the input Mic level. The +60 mic setting adds roughly 60dB to the Mic level. The line setting also allows for a normal audio input at line level to be fed into the audio mixer.

SAFETY FIRST: Always connect any audio connections with the equipment powered off and set the audio mixer faders or any headset volume knobs to minimum. Then turn on the equipment before slowly raising the audio faders or headset volume to a desired comfortable level.

+48V Switch – Phantom power

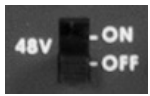

The HS-600 also has the ability to power a *Condenser microphone* circuit; this is sometimes referred to as Phantom power. Only switch this on if your connected XLR microphone or active box is compatible with 48V DC Phantom Power as there are other types.

Only supply Phantom Power from one item in the chain. Two units supplying phantom power into the same audio chain could damage the audio circuit in one of the devices.

In some cases a Condenser microphone may also have a battery compartment and you need to double check whether this battery should be removed whilst using Phantom power to also avoid battery damage.

Most Dynamic microphones do not rely on phantom power but may still need to be pre-amplified using the Line and Mic switch described above.

Unbalanced RCA connectors



The HS-600 has two unbalanced RCA or Phono input connectors. These inputs, coloured red and white, are line level inputs only. You should not attempt to connect a microphone here directly as it may be too low. These inputs can be used to supply a stereo input (maybe the output of a small audio mixer or background music) or two separate mono audio channels left (L) and right (R).

RCA connections are unbalanced audio connections and should not be run for long distances as they can be affected by external noise from nearby electrical and magnetic sources.

Balanced 3pin XLR connectors



The HS-600 has two balanced XLR input connectors, each with 3 pins. These XLR inputs are associated with the Line and Mic Switch as well as the Phantom power switch. These inputs can be used to supply a stereo input (maybe the output of a larger audio mixing desk) or two separate mono audio channels left (L/CH1) and right (R/CH2) for microphones.

Balanced XLR connections offer some protection against external noise from electrical and magnetic sources. These connections can therefore be used to run audio signals much further.

Keyboard Controls - Audio

Audio Mixer and Faders

These CH1, CH2, RCA and MASTER Audio sliders/faders control the audio output mix and level.



Master

Slider/Fader controls the audio level for the Main audio output mix.

CH1 / CH2 / RCA

These Sliders/Faders correspond to the rear inputs and control the relative volume of each input in the master output as well as the master output level. They are called faders because they are used to decrease (rather than increase) the signal levels to make a balanced and pleasing audio mix.

When these faders are set at Unity (0dB), they pass the audio signal through at the same level it was at when it entered this bus. This is why setting the level at the Input Bus is so important. See previous page **Line and Mic switch** and the **Audio mixer menu** section on the following page.

SAFETY FIRST: Always connect any audio connections with the equipment powered off and set the audio mixer faders or any headset volume knobs to minimum. Then turn on the equipment before slowly raising the audio faders or headset volume to a desired comfortable level.

Audio Peak Meter

These LED style peak meters show the audio signal strength at either the audio input bus or the mixed audio "Master" output. The signal they measure is set by the Audio Monitor Button and the levels set at the Faders.



Audio Monitor Button

Use the Headphone output on the front edge of the HS-600 keyboard to accurately monitor any of the sources CH1, CH2, RCA or "Master" output. Repeated presses of the Audio Monitor button cycle an LED through the monitoring choices just above the Audio Peak Meter. In many cases, headphones will be a more useful and accurate choice than speakers for audio monitoring. See Headphone Volume Control also.

A+V Button

When this button is engaged the audio associated with a selected video input source is fed to the program and audio outputs. When the button is inactive, audio must be switched or selected manually. For more information, read the section A+V on the **page 33**.

Headphone Volume Control

This controls audio volume level presented at the case speakers, headphone or headset sockets. In many cases, headphones will be a more useful and accurate choice than speakers for audio monitoring. When connecting headphones or headset the case speakers are muted.



SAFETY FIRST: Always connect any audio connections with the equipment powered off and set the audio mixer faders or any headset volume knobs to minimum. Then turn on the equipment before slowly raising the audio faders or headset volume to a desired comfortable level.

Audio selection for Headphone and Headset sockets

Headphone audio can be selected by using the LCD, INTERCOM and MIXER buttons. The button selected will supply the matching audio to the connected Headphones.

LCD - relates to any audio fed through the LCD panel, for example the HDMI monitor input.

INTERCOM - relates to ITC-50 communication channel for audio monitoring only.

MIXER - relates to the audio mixer monitor output as selected by the Audio Monitor Button.

These buttons have the same effect over the audio heard at the 3.5mm Headset socket.



Audio Mixer Menu

We have already discussed the rear panel inputs and their associated keyboard controls for audio. This section covers the audio mixer menu options which provide several useful features such as test tone, audio delay, audio gain level and audio follows video selections (A+V).

- 1: COUNT_DOWN_TIME
- 2: PIP
- 3: CG (LUMA KEY)
- 4: LOGO
- 5: VIDEO IN & OUT
- 6: AUDIO MIXER**
- 7: MULTI. IMAGE
- 8: SYSTEM
- 9: STORE RECALL & UPDATE
- 10: RESET DVI_IN
- ESCAPE

The HS-600 is set up by a series of menus. Once the initial settings have been chosen they are stored within the system, so it may only be necessary to make these changes once.

When the **SETTING** button is pressed in the **EFFECTS** area of the HS-600 keyboard the Main Menu list, shown left, is displayed between the PST and PGM images on the Multi-Image Preview output.

This menu option allows the user to change settings which effect audio coming into or going out of the HS-600. Use the arrow buttons to highlight the **AUDIO MIXER** item then press the **ENTER** button to confirm the selection.

Sending a test tone from the HS-600

Options 1 and 2 of the Audio Mixer Menu allow you to produce a 1KHz test tone at a set level. This test tone overrides any audio already at the HS-600 audio outputs. This can be useful when setting up equipment such as recorders and speakers before a production starts.

[AUDIO MIXER SETTING-1]		
1: TONE OUT	= OFF	(ON/OFF)
2: TONE LEVEL	= +04 dBu (18 ~ - 34)	XLR
3: CH1 DELAY TIME	= 1.0 FRAMES	(0 ~ 30)
4: CH2 DELAY TIME	= 1.0 FRAMES	(0 ~ 30)
5: AUX DELAY TIME	= 1.0 FRAMES	(0 ~ 30)
6: CH1 GAIN	= + 0 dB	(0 ~ +18)
7: CH2 GAIN	= + 0 dB	
8: AUX GAIN	= + 0 dB	
NEXT PAGE		

Delaying audio to re-sync video

Video is delayed longer in the mixing process because more data is required to create the image. If video effects like Luma key and Picture in Picture are added then the video delay is longer because more processing time is required. As audio can be created with much less data it can travel through a mixer faster than the video it is associated with. The audio reaches the viewer's ears before the image shows the actor talking. This creates an issue were the viewer is distracted from the performance because the video of the actor talking is not in step with the audio being heard.

Options 3, 4 and 5 of the Audio Mixer Menu (above) allow you to correct any minor lip sync issues between the mixed audio and the mixed video output for recording or transmission purposes. It is not possible to use this feature to match the mixed audio to any live performance. All mixed outputs, video or audio, will always be slightly behind the live performance.

Increasing audio input Gain

As well as being able to lift the incoming signal level at the XLR inputs with the Mic and Level switch there is a further way to boost the audio within the mixer. Using options 6, 7 and 8 of the Audio Mixer Menu will allow you to raise the gain of the selected audio input by a further +6, +12 or +18 dB. This is best adjusted during the testing and set up stage well before the production starts.

SAFETY FIRST: Always connect any audio connections with the equipment powered off and set the audio mixer faders or any headset volume knobs to minimum. Then turn on the equipment before slowly raising the audio faders or headset volume to a desired comfortable level.

Audio follows video selection (A+V)

The Audio Mixer Menu is split across two pages. In order to see the second page of options use the arrow keys to highlight NEXT PAGE and then press ENTER. The following screen will then be shown between the PST and PGM images on the Multi-Image Preview output.

[AUDIO MIXER SETTING-2]			
VIDEO SELECT AUDIO:	CH1	CH2	AUX
1: VIN CH1 SELECTION =	ON	----	----
2: VIN CH2 SELECTION =	ON	ON	----
3: VIN CH3 SELECTION =	ON	ON	ON
4: VIN CH4 SELECTION =	----	ON	ON
5: VIN CH5 SELECTION =	----	----	ON
6: VIN CH6 SELECTION =	----	----	----
7: VIN CH7 SELECTION =	ON	----	ON
8: VIN CH8 SELECTION =	ON	----	ON
ESCAPE			

The table of settings on this menu page are referred to by the mixer as audio choices when the A+V (audio follows video) button is ON.

These audio choices can be changed by using the arrow keys to highlight the Video Input (VIN) and then the required audio channel to the right.

Pressing the arrow up or arrow down buttons will toggle the selected audio channel ON or OFF (- - -) for that particular video selection.

So in our example, with the A+V button ON and using the above audio video pairings. Choosing or switching to video channel 3 on the MAIN SOURCE row will show channel 3 video plus audio from all audio inputs at the program outputs of the mixer.

By comparison, still using our example table above, if we choose channel 6 then we will show channel 6 video only and all audio will be muted.

As we transition from one video source to another so the audio will change in step with our table of choices above. This could be useful in a studio setting where you are transitioning between Host and Guest on a chat show or in a newsroom when switching from the newscaster to an interview being played back from a recorder.

In this A+V mode the audio faders/sliders only have an effect on the level of any audio source that is turned ON.

If you wish to return to normal audio operation and only use the audio faders just press the A+V button again so it is turned OFF.

Changing the Multi-Image Preview

The appearance and some of labels on HS-600 Multi-Image Preview can be changed by the user.

- 1: COUNT_DOWN_TIME
- 2: PIP
- 3: CG (LUMA KEY)
- 4: LOGO
- 5: VIDEO IN & OUT
- 6: AUDIO MIXER
- 7: MULTI. IMAGE**
- 8: SYSTEM
- 9: STORE RECALL & UPDATE
- 10: RESET DVI_IN
- ESCAPE

When the **SETTING** button is pressed in the **EFFECTS** area of the HS-600 keyboard the Main Menu list, shown left, is displayed between the PST and PGM images on the Multi-Image Preview output.

Option 7: MULTI. IMAGE allows the user to change settings which effect the labelling and appearance of this DVI based preview output.

Use the arrow buttons to highlight the **MULTI. IMAGE** item then press the **ENTER** button to confirm the selection.

The settings for the Multi-Image Preview are covered across two menu pages. The first page of options is shown below.

- [MULTI. IMAGE SETTING-1]
- 1: OUTPUT TYPE = 16 : 9
- 2: BORDER BRIGHT = 001
- 3: DVI_TX_EMPHASIS = ON (LONG CABLE)
- 4: DVI_TX_PRE_DRIVE = ON (LONG CABLE)
- 5: DVI1_DE_SKEWING = +0
- 6: DVI2_DE_SKEWING = +0
- NEXT PAGE**

1: OUTPUT TYPE – This option allows the user to modify the aspect ratio of all image windows in the Multi-Image preview. The user can choose between 4:3 and 16:9.

2: BORDER BRIGHT – This option allows the user to adjust the brightness of the border of all image windows in the Multi-Image preview. The user can choose a greyscale value between 000 (Black) and 100 (White).

Options 3, 4, 5 and 6 – These options are used to adjust the DVI signalling when using long cables between the mixer and the monitor being used to display the Multi-Image Preview.

Labels

To display the second page of options use the arrow keys to highlight **NEXT PAGE** then press **ENTER**.

- [MULTI. IMAGE SETTING-2]
- 1: CAM1_NAME** =[CAM1]
- 2: CAM2_NAME =[CAM2]
- 3: CAM3_NAME =[CAM3]
- 4: CAM4_NAME =[CAM4]
- 5: CAM5_NAME =[CAM5]
- 6: CAM6_NAME =[CAM6]
- 7: CAM7_NAME =[CAM7]
- 8: CAM8_NAME =[CAM8]
- ESCAPE

The second page of options allows the user to change each of the labels for each of the input preview windows. The labels for the AUX, PST and PGM images cannot be changed by the user. To change a label use the arrow keys to highlight the first character of the selected input. Then use the up or down arrows to change the selected character. Use the left and right arrows to move to the next character in the label. Once the label is complete press the ENTER key. Each label has a maximum length of six characters.

GPI / GPO Connections

The HS-600 can be controlled externally via a simple contact closure GPI (General Purpose Interface) switch. This could be a push button, foot switch or any relay or any circuit that is able to provide a simple contact closure.

The GPI interface is a 3.5mm Jack Socket which is situated on the rear panel of the HS-600. Contact closure between the Outer and Inner contacts on the jack plug will trigger a user selected event. Power is supplied by the HS-600 and is less than 5V DC.

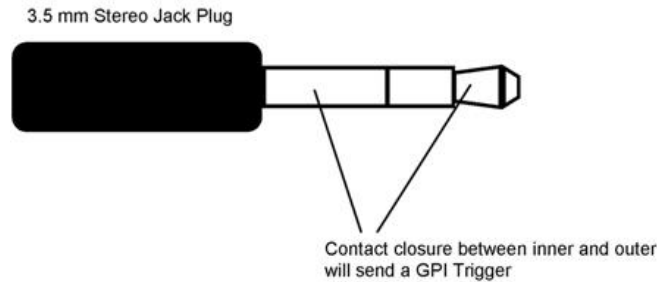

This GPI socket can also be used as a GPO socket to trigger record or playback events with other equipment such as the Datavideo DN-200, DN-400 or DN-500 recorders.

SAFETY FIRST The cabling required needs to be designed specifically to connect the HS-600 to the chosen record or playback device as they are not all the same. The cabling required can be made by yourself or purchased. Please speak with your Dealer or local Datavideo office to get further help and advice.

- 1: COUNT_DOWN_TIME
- 2: PIP
- 3: CG (LUMA KEY)
- 4: LOGO
- 5: VIDEO IN & OUT
- 6: AUDIO MIXER
- 7: MULTI. IMAGE
- 8: SYSTEM**
- 9: STORE RECALL & UPDATE
- 10: RESET DVI_IN
- ESCAPE

When the **SETTING** button is pressed in the **EFFECTS** area of the HS-600 keyboard the Main Menu list, shown left, is displayed between the PST and PGM images on the Multi-Image Preview output.

Option 7: MULTI. IMAGE allows the user to change settings which effect the labelling and appearance of this DVI based preview output.

Use the arrow buttons to highlight the **SYSTEM** item then press the **ENTER** button to confirm the selection.

The settings for the Multi-Image Preview are covered across two menu pages. The first page of options is shown below.

- [SYSTEM SETTING]
- 1: GPI SETTING**
 - 2: SPEED KEY SETTING
 - 3: KEY'S BRIGHTNESS=
 - ESCAPE

- [[GPI SETTING]]
- 1: GPI_IN ON/OFF = OFF
 - 2: GPI_IN FUNC. = CUT
 - 3: GPI_OUT ON/OFF = OFF
 - 4: GPI_OUT TRIGGER KEY = MAIN_6
 - 5: GPI_OUT MODE = USER DEFINE.
 - 6: GPI_OUT DELAY = 0 FRAMES
 - 7: GPI_OUT SIGNAL WIDTH = 1 FRAME
 - ESCAPE

Store and recall function

The HS-600 has the ability to store your usual settings to one of three back up memory points within the unit. This can be handy if you find someone has changed your usual set up and you need a quick way to get back to your stored standard set up.

Alternatively you can use the system reset to return the mixer to the out of the factory default settings instead.

The store and recall function can also be used to update the firmware of the mixer. The firmware update process is described later in this manual.

- 1: COUNT_DOWN_TIME
- 2: PIP
- 3: CG (LUMA KEY)
- 4: LOGO
- 5: VIDEO IN & OUT
- 6: AUDIO MIXER
- 7: MULTI. IMAGE
- 8: SYSTEM
- 9: STORE RECALL & UPDATE**
- 10: RESET DVI_IN
- ESCAPE

When the **SETTING button** is pressed in the **EFFECTS** area of the HS-600 keyboard the Main Menu list, shown left, is displayed between the PST and PGM images on the Multi-Image Preview output.

Option 9: STORE RECALL & UPDATE allows the user to store the current settings of the HS-600 mixer or recall them from its memory.

Use the arrow buttons to highlight option 9 then press the **ENTER** button to confirm the selection.

The settings for the STORE RECALL & UPDATE are covered across two menu pages. The first page of options is shown below.

- 1: STORE & RECALL SETTING**
- 2: UPDATE FIRMWARE
- 3: RESET ALL (Press '▶' key 2 SEC.)
- ESCAPE

3: RESET ALL (Press '▶' key 2 SEC.) – This reset option allows the user to clear any current settings and return to the mixers factory default values. It does not affect any audio or stored settings in the three backup memory slots.

2: UPDATE FIRMWARE – The firmware update process is described later in this manual, **see page 39**.

1: STORE & RECALL SETTING – Use the arrow buttons to highlight option 1 then press the **ENTER** button to confirm the selection. The following options will then be displayed.

- [STORE & RECALL SETTING]
- 1: RECALL SETTING FROM** : BACKUP_1
- 2: STORE SETTING TO : BACKUP_3
- 3: RESET CURRENT SETTING : NO
- ESCAPE

1: RECALL SETTING FROM – This option allows the user to recall the stored settings from one of three backup memory slots. Use the up or down arrow keys to change the selected memory slot. Press enter to start the recall process.

2: STORE SETTING TO – This option allows the user to store the current settings to one of three backup memory slots. Use the up or down arrow keys to change the selected memory slot. Press ENTER to start the store process.

3: RESET CURRENT SETTING – This reset option allows the user to clear the current settings and return to the factory default values. At the same time all backup memory slots are returned to their factory defaults also.

This feature effects all mixer video settings except the audio mixer settings which still need to be amended manually.

HS-600 Tally Outputs

The HS-600 is already prewired internally for Tally signals to be fed via the ITC-50 belt packs. Please see page 41 for more information on the ITC-50 Intercom and tally.

How to update the HS-600 Switcher Firmware

From time to time Datavideo may release new firmware to fix reported bugs in the current HS-600 firmware or to add a new feature. Customers can update the HS-600 switcher firmware themselves if they wish or they can contact their local dealer or reseller for assistance should they prefer this method.

This page describes the firmware update process for the complete unit, if you have all the items required it should take **approximately 20 minutes total time to complete**.

Once started **the update process should not be interrupted in any way** as this could result in a non-responsive unit.

As well as a working HS-600 you will need:

- The latest Firmware update files for the HS-600.
This can be obtained from your local Datavideo office or dealer.
- The HS-600 power supply.
- A formatted / empty SDHC card that is large enough to hold the update files.
- A computer with SDHC card slot or SDHC card reader.

To update the HS-600 firmware:

1. Switch off the HS-600 in the normal way.
2. Unzip the firmware update folder to the computer desktop so the file(s) within it are easy to locate.
3. Copy and paste all the files inside the folder to the formatted / empty SDHC card.
4. Insert the SDHC card into the SD card slot on the front edge of the HS-600 keyboard.
5. Turn on the HS-600 and the unit will start normally.
6. Now enter the SETTINGS menu and choose option 9 : STORE, RECALL & UPDATE.
7. In the next menu screen choose option 2 : UPDATE FIRMWARE.
8. Select update mode option 1 : NORMAL then choose option 1 : ALL.
9. Press the CUT button on the HS-600 keyboard next to the T-BAR to start the update process.
10. The unit will proceed with the update. Progress will be shown within the Multi-Image Preview.
11. If successful the update process will end with a message on the Multi-Image Preview confirming how to exit the update option.
12. Once successfully updated **the unit will need to be reconfigured for PIP and LUMA KEY etc** as any previous settings will be changed by the update. For the same reason any LOGO images may need to be reloaded.

***WARNING:** *Once the update has been started, DO NOT turn the power off until the process is complete. The update process waits at certain points, this is normal, allow it plenty of time to continue. If the update is prematurely ended by mistake, loss of power or shows an error then the HS-600 may be made inoperable. Please contact your local Datavideo dealer or office for help and advice if the update appears to have failed.*

It is possible to update certain parts of the HS-600 firmware individually. This is an advanced feature. Please only attempt this with guidance from your local Datavideo Office as certain mixes of firmware could make the unit non-responsive.

Optional DV and SDI output board

The HS-600 can be supplied with, or without, an optional DV and SDI board fitted. Please check with your dealer which model you should have.

The DV and SDI board has two 6 pin IEEE-1394 DV ports and two SDI BNC connections. All connections on this board are outputs.

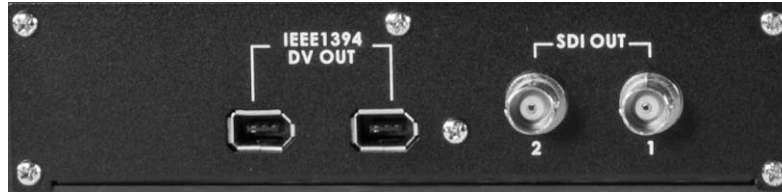

The two DV25 outputs carry audio as well as video. The DV output can be connected to a DV25 deck or recorder such as the Datavideo DN-60, DN-200, DN-400 or DN-500. Alternatively you could also connect this DV output to a computer DV capture card.

SAFETY FIRST: Care should be taken when connecting 6 pin DV cabling as the connector carries power as well as data. The DV connector is shaped so that it is connected in one way only. Forcing the DV cable into the DV socket the wrong way around can cause damage by short circuit of the power contacts. This type of damage is not covered by warranty so please be careful.

The two standard definition SDI outputs also carry embedded audio as well as video. These SDI outputs can be connected to an SDI monitor such as the Datavideo TLM-170H or a recorder such as the Datavideo HDR-40, HDR-50, HDR-45 or HDR-55. Alternatively you could also connect this SDI output to a computer SDI capture card, or a computer SDI CG overlay card or a Satellite transmission link.

SDI signals from this card can be sent over standard SDI 75 Ohm BNC cabling for 100m before needing to be re-clocked. A Datavideo VP-445 SDI distribution amplifier (one input, four outputs) could re-clock this signal.

- 1: COUNT_DOWN_TIME
- 2: PIP
- 3: CG (LUMA KEY)
- 4: LOGO
- 5: VIDEO IN & OUT**
- 6: AUDIO MIXER
- 7: MULTI. IMAGE
- 8: SYSTEM
- 9: STORE RECALL & UPDATE
- 10: RESET DVI_IN
- ESCAPE

The HS-600 is set up by a series of menus. Once the initial settings have been chosen they are stored within the system, so it may only be necessary to make these changes once.

When the **SETTING** button is pressed in the **EFFECTS** area of the HS-600 keyboard the Main Menu list, shown left, is displayed between the PST and PGM images on the Multi-Image Preview output.

This menu option allows the user to change settings which effect video coming into or going out of the HS-600. Use the arrow buttons to highlight the **VIDEO IN & OUT** item then press the **ENTER** button to confirm the selection.

- [IN / OUT SELECT]
- 1: INPUT
- 2: OUTPUT
- 3: ASSIGN VIDEO SOURCES
- 4: DV & SDI**
- ESCAPE

- [DV & SDI]
- 1: SDI_OUT SOURCE = **MAIN OUT**
- 2: SDI AUDIO CHANNEL= 1/2 (GROUP1)
- 3: DV_OUT MODE = mode_1
- ESCAPE

It is possible to change the SDI output to show either the MAIN (Program) output, SUB (Preview) output or one of the AUX outputs. Mixed program audio can be embedded into a chosen group of two SDI audio channels. The DV out mode cannot be changed.

ITC-50 Intercom



The built in ITC-50 intercom system provides communication and tally indications from the director to the crew. The director working at the HS-600 keyboard can choose to talk to a single belt pack channel or to all channels.

CB-3 5pin XLR cabling connects between the rear panel of the HS-600 and the supplied belt packs. These belt packs also provide cued (amber) and live (red) tally signals from the HS-600 video switcher to an attached TD-1 tally light.

The HS-600 comes with single ear and mic MC-1 starter headsets. These headsets can be used with the belt packs or at the director's position on the HS-600. Alternatively the director can work with standard headphones using the 1/4" headphone socket and the supplied XLR gooseneck condenser microphone.

ITC-50 connections and Controls



USB Power socket

This socket is for use with the supplied USB LED keyboard light. This socket is not a data connection and should not be connected to a computer.

SAFETY FIRST Remember to unplug the USB light before attempting to close the lid of the HS-600 otherwise you may damage the USB Socket, Light and Monitor.



XLR Microphone Socket

Combined XLR / 1/4" (6.3mm) Jack Microphone Input for either a Condenser or Dynamic Gooseneck Microphone. If a headset with mic is used at the 3.5mm socket then the XLR microphone is made redundant.

XLR 3pin connector supports Condenser Microphones.

Centre 1/4" (6.3mm) Jack socket supports Dynamic Microphones.



ALL Button

Opens communication with all channels. All channels will hear communication from the operator, or from any other channel using the TALK button.



Channel Buttons 1~8

Opens communication with individual channels. More than 1 channel can be active at any given time, active channels are illuminated red.

All active channels will hear any communication from the operator or from any other active channel.

The buttons will also indicate if any channel is paging, the paging channel will flash in orange until the page is answered.



MUTE Button

Mutes all communication from the base station or any channel.

NOTE If any channel uses the CALL button the paging tone will still sound even when the MUTE button is active.



Headphone/Headset Volume Control

A headset and/or headphones can be used to monitor ITC-50 communication at the HS-600 keyboard. **See pages 33 and 9.**



ITC-100SL Slave Unit

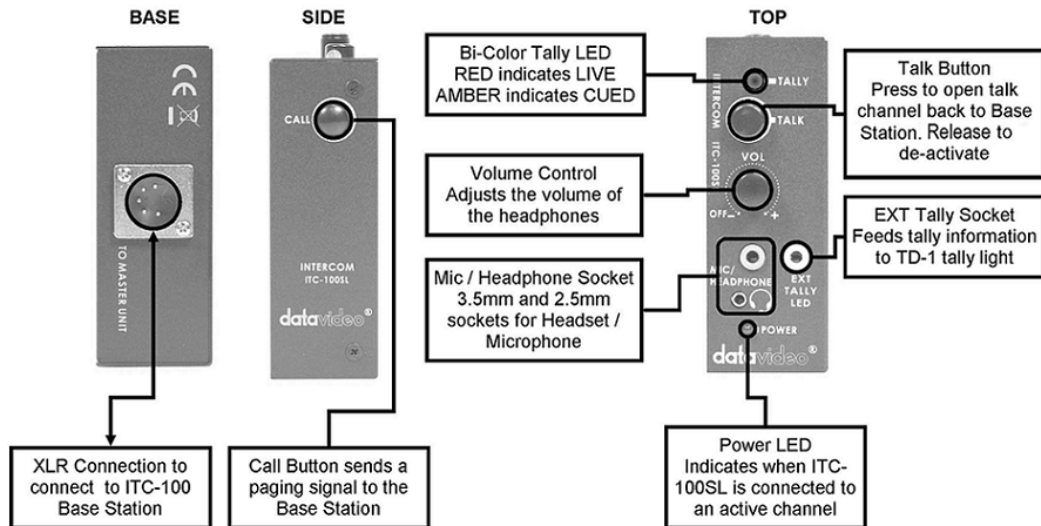

XLR Connection

Connects the ITC-100SL to the ITC-50 Base Station. Power, tally and bi-directional audio are all carried through the same cable.



Call Button

Sends a paging message to the ITC-50 Base Station. The channel button will flash orange and there will be an audible tone, each time the button is pressed.



Bi-Colour Tally LED

Will illuminate RED when the channel is LIVE and AMBER when the channel is CUED



Talk Button

Opens up talk back communication with the ITC-50 base station, and any other active channels. Press the button to talk; release the button to end communication.

PLEASE NOTE: It is important to release the talk button as soon as you have finished talking, otherwise it will become distracting and confusing for other members of the crew.



Volume Control

Adjusts the volume of the attached headphones. It also controls the level for the mic and paging tone heard when the belt pack is called.



Mic / Headphone Socket

The ITC-100SL has both 3.5mm and 2.5mm Mic / Headset socket. A standard 3.5mm Mic / Headset can be used, or a Motorola type 2.5mm Mic / headset could be used if preferred.



External Tally LED Socket

An external tally display (TD-1) can be connected to the ITC-100SL. This enables the tally light to be positioned in a more convenient place, such as on top of the camera. When the channel is LIVE the LED will be RED, and when the channel is CUED the LED will be AMBER. **N.B. The Tally LED on the ITC-100SL will continue to operate as normal when a TD-1 has been added.**



Power LED

The Power LED indicates when the channel is active. If the operator has opened the channel by pressing the channel button 1 ~ 8, or by pressing ALL then the LED will light up. **N.B. The tally indicator lights will continue to work even when the Power LED is not on, and the channel is not active.**

Cable Assignments Headset, Jack plug and 5pin XLR

Please Note: If you only want to extend the reach of the ITC-100SL Belt Pack cabling then Datavideo already sell pre-manufactured XLR cabling for doing this in 20m (CB-3) and 50m (CB-4) lengths. Please ask your local dealer for price and availability of additional CB-3 and CB-4 cables.

CB-3 XLR cable / 5pin XLR Connector on ITC-100SL

Pin	Cable	Assignment
1	Red	Tally Red
2	Black	Tip (Talk & Call)
3	Shield	Common with Ground of XLR
4	Green	12v DC power to ITC100SL
5	White	Tally Yellow

5pin XLR Cable is a straight through cable pin 1 to pin 1, pin 2 to pin 2 etc

ITC-100SL Belt pack 3.5mm Jack socket Headset connector

Please Note: For connecting a professional headset Datavideo can supply a mini jack to XLR adaptor cable which would support headsets with a Dynamic microphone. Please contact your dealer or local Datavideo office for more information on this XLR to Jack plug adaptor cable.

In the case of a professional headset with an Electret microphone a small SDM of 1yf/1uf (for decoupling ac hum) will be required on the Jack Tip/XLR pin 2 cabling.

Jack	Headset XLR	Assignment
Tip	Pin 2	Microphone (can be Dynamic or Electret)
Ring	Pin 4	Earphone (Impedance range 8-100 Ω) (ideally 30-40 Ω)
Ground/Sleeve	Pins 1 & 3	Common Ground

HS-600 Monitor



The 17.3" display built into the HS-600 lid has controls which allow selection of source inputs for Mixer Program, Mixer Preview or HDMI input as well as PIP, Aspect Ratio, Blue only, Pattern (Colour Bars), Menu and Audio.

The monitor's On Screen Display (OSD) MENU, arrow buttons and ENTER button allow control and set up of brightness, contrast, saturation, hue, sharpness and colour temperature. Additional menus can also be used to display Picture in Picture, onscreen overlays for 80% or 90% Frame Marker, 4:3 Marker, 16:9 Marker, Cinema Zone Marker, and Centre Point.

HDMI, PREVIEW, PROGRAM

Select the type of input you wish to view - HDMI, PREVIEW or PROGRAM. The active selection will be indicated by a red LED on the chosen button.

When you select "**PROGRAM**", you select the mixed program output of the HS-600; this is a full screen display.

When you select "**PREVIEW**", you will see a multi-image preview from the mixer.

When you select "**HDMI**", you select the HDMI source input on Rear Panel; this is a full screen display like Program and could be the input from a recorder for confidence monitoring of the recording.

BLUE

Press this button to eliminate the red and green component of input signals. Only the blue component of an input is displayed on the screen. This allows adjustments of chroma and phase. (Phase adjustment is effective with NTSC signals).

PATTERN

Press this button to display the monitors built in SMPTE colour bars pattern. This feature can be used to calibrate or change the monitor settings when using the OSD menu options.

PIP

The monitor's own PIP or Picture in Picture feature allows you to display two sources at the same time. One source will display as a full screen with the secondary source on a smaller PIP window. The mixed program output is CVBS2. The rear HDMI input (not mixed) is HDMI1. The multi-image preview is HDMI 2.

NOTE: The OSD Menu PIP options for SDI, COMP, SVIDEO and CVBS1 cannot be used as they are not connected to the HS-600 monitor.

Menu Navigation Buttons

The MENU, arrow up, arrow down and ENTER buttons are used to display and navigate the OSD set up menus.

When not using the OSD menus the **arrow down button** also toggles the Safe Area Mask On or Off. This feature may need to be set up using the OSD menus first.

When not using the OSD menus the **arrow up button** also toggles the 4:3 Mask On or Off when in 16:9 mode. This feature may need to be set up using the OSD menus first.

MUTE Button

Mutes the audio from the internal speakers or headphone socket.

Volume Control

Adjusts the speaker / headphone volume up / down.

Aspect Ratio Button

Toggles the Aspect Ratio of the display between 16:9 and 4:3

Menu Options

The HS-600 monitor set up via On Screen Display (OSD) menus. To show the OSD menus press the MENU button. The menus are navigated using the Up / Down buttons.

There are six main menu options:

- Video Processor,**
- PIP Feature Setting,**
- Audio Function Setting,**
- Special Function I,**
- Special Function II,**
- System Information.**

Video Processor

Highlight the Video Processor option and press the ENTER button. The first option for setting Brightness will then be highlighted.

To adjust the Brightness value press ENTER again. An adjustment bar will appear at the bottom of the screen.

Use the Up and Down arrow buttons to adjust the setting and then press ENTER again to store the new value and return to the Video Processor menu.

To select a different setting (Brightness, Contrast, Saturation, Hue, Sharpness and Color Temp.) use the arrow Up or Down buttons to highlight the required option then follow the same steps as described for brightness above.

PIP Feature Setting

To access the menu press ENTER so that PIP Mode is highlighted

To access the options for the selected setting press ENTER again, so that the option column is highlighted - In this case Large PIP.

Use the Up / Down buttons to navigate the available options.

You can choose:	PIP Mode	Large PIP / Small PIP
	PIP Position	Bottom-Right / Top-Left / Top-Right / Bottom Left
	PIP Main Source	CVBS 1 / CVBS 2 / SVIDEO / COMP. - Component HDMI 1 / HDMI 2 / SDI
	PIP Sub Source	CVBS 1 / CVBS 2 / SVIDEO / COMP. - Component HDMI 1 / HDMI 2 / SDI

NOTE: The PIP feature can only be one analogue source and one digital source. i.e. If the main source is analogue then the sub source must be digital, and vice versa.

Examples:

Main Source	=	CVBS 2 only
Sub Source	=	HDMI 2 or HDMI 1
Main Source	=	HDMI 2 or HDMI 1
Sub Source	=	CVBS2 only

The mixed program output is CVBS2.
The multi-image preview is HDMI 2.
The rear HDMI monitor input (not mixed) is HDMI 1.

NOTE: The OSD Menu PIP options for SDI, COMP, SVIDEO and CVBS1 cannot be used as they are not connected to the HS-600 monitor.

Audio Functions Setting

The monitors Audio Functions Setting Menu allows you to adjust the Internal Speaker Mute Control, External Speaker Mute Control and Audio Indicator for the HDMI monitor input (not mixed).

To access the options for the selected setting press ENTER again, so that the option is highlighted

Use the Up / Down buttons to navigate the available options.

You can choose:	Internal Speaker	On / Off / Mute Control
	External Speaker	On / Off / Mute Control
	Audio Indicator	On / Off

Special Function I

The Special Function I menu has settings for the Frame Ratio, Safe Area, Scan Mode, Central Mark, Cinema Zone Mark and Mask Type.

To access the options for the selected setting press ENTER again, so that the option column is highlighted

Use the Up / Down buttons to navigate the available options.

You can choose:	Frame Ratio	Off / 80% / 90%
	4:3 Mark Line	On / Off
	Scan Mode	Underscan / Over Scan
	Central Mark	On / Off
	Cinema Zone Mark	On / Off
	Mask Type	Overlay / Transparent

NOTE: Frame Ratio - This will display a "Safe Area" frame on the screen

Special Function II (no Timecode input)

The Special Function I Menu has limited settings for the Time Code Setup** and Title Editor.

To access the options for the selected setting press ENTER again, so that the option column is highlighted

Use the Up / Down buttons to navigate the available options.

You can choose:	Time Code Setup**	Product limitation - The time code settings here are redundant as the HS-600 mixer does not provide SDI connection internally to the built in monitor. This feature will not work with the HDMI input.	
	Title Editor	Title Display	On / Off
		Title Position	MID_TOP / MID_BOT
		Font Size	Small / Large
		Edit Title	Pos: 1~15 Char: A~Z

Title Editor can be used to create an on screen title which is only shown on the HS-600 monitor. This title can be up to 15 characters long.

System Information

The System Information Menu displays the Firmware Version of the monitor, and offers a Factory Reset option, which will return all the settings of the monitor to the factory defaults.

To access the options for the selected setting press ENTER again, so that the option column is highlighted

Use the Up / Down buttons to navigate the available options.

You can choose:	Black Light	1=Dark (Min) 12=Bright (Max)
	Factory Reset	Yes / No
	Firmware version	170H-110729-L
	Panel Resolution	1600x900

To Factory Reset the monitor press the ENTER button, so that Factory Reset is highlighted, and then press ENTER again to highlight the option. Use the UP / Down button to select YES from the options and then press ENTER to reset the monitor. After a few seconds the monitor will be reset.

RS-422 Protocol

The HS-600 can be controlled remotely by computer using the RS-422 protocol for the SE-600 switcher. This is a professional feature that requires programming and/or prior experience. Your dealer or local Datavideo office can supply you with a copy of the separate RS-422 Protocol document which has been written with experienced system integrators and programmers in mind. Please note Datavideo cannot offer training or bespoke software in regard to this feature.

Dimensions

All measurements in millimetres (mm).

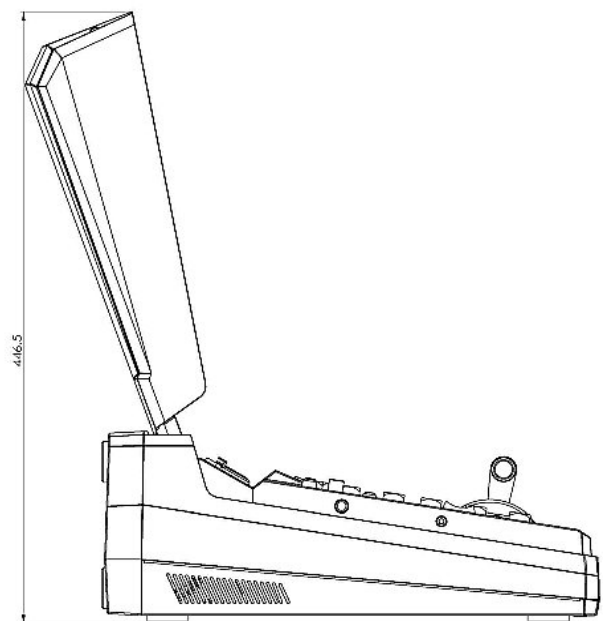
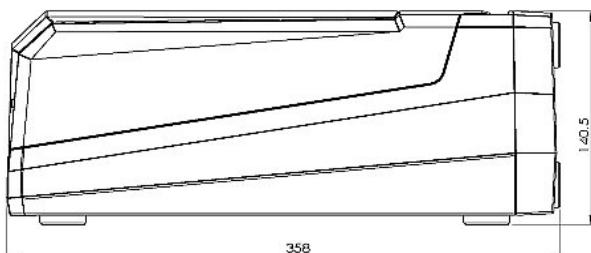
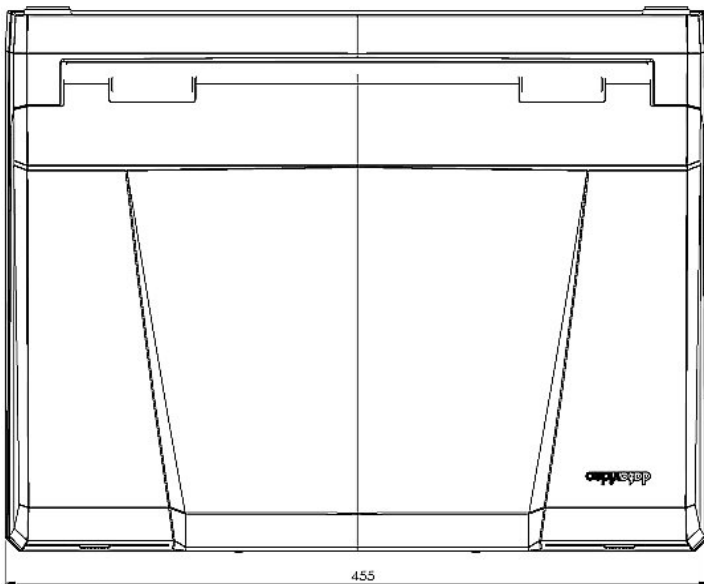

HS-600 Switcher Specification

Video Inputs	<ul style="list-style-type: none"> *Composite Video (BNC) x6 *DVI-D x1 *DVI-I x1
Outputs	<ul style="list-style-type: none"> *Main outputs: Depending on OSD menu option either CVBS x2 and Y/C or CVBS x1 and YUV x1 *Aux (1) outputs: CVBS x 2 *Aux (2) outputs: CVBS x 2 <p>If HS-600 fitted with Optional DV & SDI card</p> <ul style="list-style-type: none"> *DV25 Outputs: IEEE-1394 x2 (Optional) *SDI (BNC) x2 (Optional)
Video Formats	<p>Analogue Y.U.V. Video (SONY Betacam standard) Y/C and Composite at CCIR601 NTSC/PAL Optional SDI (Support SMPTE 259M-C 270Mbps) Optional DV25 format at Y.U.V. 4:1:1 NTSC or Y.U.V. 4:2:0 PAL 25Mbps bit rate</p>
IRE Black Level	Options 0 or 7.5 IRE (NTSC only)
Effects	<ul style="list-style-type: none"> *Wipe and dissolve *PIP: 2 of PIP effects *Luma Key x1 *LOGO: up to two logos displayed on the same screen *One Frame still store memory as a source *SMPTE pattern out or selected colour background
Preview output	<ul style="list-style-type: none"> *2 x DVI-D for Multi-Viewer with countdown timer and audio level indicator *Resolution is 1920x1080p *Preview output includes (6x CVBS in) + (2x AUX out) screen and (1x Preset) + (1x Program) screen
Other Interface	<ul style="list-style-type: none"> *Serial D-Sub 9-pin x1 for RS-422 *Tally Output D-Sub 15-pin x2
Audio	<ul style="list-style-type: none"> *Bandwidth 20~18KHz *S/N Ratio >70 dB (Line-in) *THD < 0.1%
Audio Mixer	<ul style="list-style-type: none"> *Inputs: XLR with MIC (48V) Input x2 RCA Line In x2 *Outputs: XLR x2 , RCA x2 *LED audio-level indicator (for audio monitoring) *Audio follows Video switch (A+V)
Operating Temperature	0°C to 40°C (32°F to 102°F)
Humidity	10% to 90% (non condensing)
Dimension	425 mm x 98.93 mm x 389.24 mm (Excluding protrusion)
Weight	Gross packed incl. accessory kit 21 kg (46.3 lbs) Nett unit only 8.6 kg (19 lbs)
Power	Input AC 100 ~ 240V Switching Adaptor, output DC 12V / 5A (60W)

ITC-50 Specification

INPUTS & OUTPUTS	MIC / HEADSET	3.5mm Stereo Jack Socket for combination Headphone / Microphone Headset Impedance 8~600 ohms 100mW(min)
	HEADPHONE	¼" (6.3mm) Stereo Headphone Socket Headset Impedance 8~600 ohms 100mW(min)
	MICROPHONE	3 Pin XLR / ¼" (6.3mm) Jack Microphone Socket Switchable Condenser / Dynamic Input. Microphone Level -67dB
FREQUENCY RESPONSE		550-3.6KHz, < +/-3dB
THD		< 3%
S/N		> 50dB
BUILT-IN SPEAKER		70mm x 30mm 32 Ohm 3 Watts

ITC-100SL Specification

INPUT	5 Pin XLR Connector
MIC / HEADSET SOCKET	3.5mm Stereo Jack Socket for combination Headphone / Microphone Headset Impedance 8~600 ohms 100mW(min) Microphone Level -67Db or 2.5mm Stereo Jack Socket, for Motorola Mobile Phone type headset / microphone
TALLY OUT SOCKET	3.5mm Jack Socket to connect to TD-1 Tally Indicator
TALLY LED	Bi-Colour LED – RED indicates LIVE / AMBER Indicates CUED
POWER LED	Illuminates to indicate that power is being received

Monitor Specification

LCD

Resolution 1600 x 900
 Aspect Ratio 16:10 / 4:3
 Viewing Angle 45°/ 45°(L/R)Horizontal , 25°/45°(U/D) Vertical
 Response Time 8ms (B to W)
 Contrast 600:1
 Brightness 200 cd/m2
 Backlight LED

Audio Outputs

Terminal Connection for speaker outputs (2 Watt)
 Maximum output for speaker in FP is 2 Watts
 Headphone Socket 3.5mm Stereo Jack

Video Adjustments

Brightness 0 ~ 100
 Contrast 0 ~ 100
 Colour 0 ~ 100
 Tint (NTSC) 0 ~ 100
 Sharpness 0 ~ 24

Service and Support

It is our goal to make your products ownership a satisfying experience. Our support staff are available to assist you in setting up and operating your system. Please refer to our web site www.datavideo-tek.com for answers to common questions, support requests or contact your local office below.

Datavideo Global Website: www.datavideo-tek.com

Datavideo Corporation

Tel: +1 562 696 2324	Fax: +1 562-698-6930	E-Mail: contactus@datavideo.us
----------------------	----------------------	--

Datavideo Technologies Europe BV

Tel: +31-30-261-96-56	Fax: +31-30 261-96-57	E-Mail: service@datavideo.nl
-----------------------	-----------------------	--

Datavideo UK Limited

Tel: +44 1457 851 000	Fax: +44 1457 850 964	E-Mail: sales@datavideo.co.uk
-----------------------	-----------------------	--

Datavideo Technologies Co., Ltd

Tel: +886 2 8227 2888	Fax: +886-2-8227-2777	E-mail: service@datavideo.com.tw
-----------------------	-----------------------	--

Datavideo Technologies China Co., Ltd

Tel: +86 21-5603 6599	Fax: +86 21-5603 6770	E-mail: service@datavideo.cn
-----------------------	-----------------------	--

Datavideo Technologies (S) PTE Ltd

Tel: +65-6749 6866	Fax: +65-6749 3266	E-mail: sales@datavideo.sg
--------------------	--------------------	--

Datavideo HK Ltd

Tel: +852 2833 1981	Fax: +852-2833-9916	E-mail: info@datavideo.com.hk
---------------------	---------------------	--

Datavideo France s.a.r.l.

Tel: +33 1 60 37 02 46	Fax: +33 1 60 37 67 32	E-mail: info@datavideo.fr
------------------------	------------------------	--

Datavideo Technologies India PVT LTD.

Tel: +91 120 4309120	Fax: +91 120 4309121	E-mail: sales@datavideo.in
----------------------	----------------------	--

All trademarks are the properties of their respective owners.

Datavideo Technologies Co., Ltd. All rights reserved 2012.

Rev Date: 24/07/2012

P/N: G082060499E1