

HD/SD Recorder

HDR-60



Quick Start Guide

www.datavideo.com

Table of contents

Warnings and Precautions	3
Warranty	4
Disposal	4
Packing List	5
Introduction	5
Features	5
Connections & Controls	6
Front Panel	6
Rear Panel.....	7
Powering On	8
MENU Key Function	8
TOOL	8
FIRMWARE REVISION	8
ERASE THIS BIN.....	8
FORMAT MEDIA.....	9
UPGRADE FIRMWARE	9
MAKE MEDIA FILES.....	10
SETUP	11
RECORD SETUP	11
PLAY SETUP	11
SYSTEM SETUP	12
SAVE SETUP.....	12
RECALL SETUP	13
STATUS	14
How to Assemble 2.5" HDD in Removable Rack	15
HDR-60/70 RS-232/422 Control Command	16
Dimension	18
Specifications	19
Service & Support	20



Warnings and Precautions

1. Read all of these warnings and save them for later reference.
2. Follow all warnings and instructions marked on this unit.
3. Unplug this unit from the wall outlet before cleaning. Do not use liquid or aerosol cleaners. Use a damp cloth for cleaning.
4. Do not use this unit in or near water.
5. Do not place this unit on an unstable cart, stand, or table. The unit may fall, causing serious damage.
6. Slots and openings on the cabinet top, back, and bottom are provided for ventilation. To ensure safe and reliable operation of this unit, and to protect it from overheating, do not block or cover these openings. Do not place this unit on a bed, sofa, rug, or similar surface, as the ventilation openings on the bottom of the cabinet will be blocked. This unit should never be placed near or over a heat register or radiator. This unit should not be placed in a built-in installation unless proper ventilation is provided.
7. This product should only be operated from the type of power source indicated on the marking label of the AC adapter. If you are not sure of the type of power available, consult your Datavideo dealer or your local power company.
8. Do not allow anything to rest on the power cord. Do not locate this unit where the power cord will be walked on, rolled over, or otherwise stressed.
9. If an extension cord must be used with this unit, make sure that the total of the ampere ratings on the products plugged into the extension cord do not exceed the extension cord's rating.
10. Make sure that the total amperes of all the units that are plugged into a single wall outlet do not exceed 15 amperes.
11. Never push objects of any kind into this unit through the cabinet ventilation slots, as they may touch dangerous voltage points or short out parts that could result in risk of fire or electric shock. Never spill liquid of any kind onto or into this unit.
12. Except as specifically explained elsewhere in this manual, do not attempt to service this product yourself. Opening or removing covers that are marked "Do Not Remove" may expose you to dangerous voltage points or other risks, and will void your warranty. Refer all service issues to qualified service personnel.
13. Unplug this product from the wall outlet and refer to qualified service personnel under the following conditions:
 - a. When the power cord is damaged or frayed;
 - b. When liquid has spilled into the unit;
 - c. When the product has been exposed to rain or water;
 - d. When the product does not operate normally under normal operating conditions. Adjust only those controls that are covered by the operating instructions in this manual; improper adjustment of other controls may result in damage to the unit and may often require extensive work by a qualified technician to restore the unit to normal operation;
 - e. When the product has been dropped or the cabinet has been damaged;
 - f. When the product exhibits a distinct change in performance, indicating a need for service.

To avoid any possible static damage to your equipment please ensure your camcorder / deck is switched off when connecting or disconnecting the IEEE-1394 cable.

Warranty

Datavideo warrants that the equipment it manufactures shall be free from defects in material and workmanship for a period of 2 years from the date of product purchased. If equipment fails due to such defects, Datavideo will, at its option, repair or provide a replacement for the defective part or product.

Equipment that fails after the warranty period, has been operated or installed in a manner other than that specified by Datavideo, or has been subjected to abuse or modification, will be repaired for time and material charges at the Buyer's expense.

This warranty does not affect your statutory rights within the Country of purchase.

Disposal

For EU Customers only - WEEE Marking.

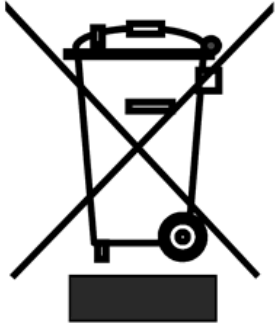

This symbol on the product indicates that it will not be treated as household waste. It must be handed over to the applicable take-back scheme for the recycling of electrical and electronic equipment. For more detailed information about the recycling of this product, please contact your local Datavideo office.

Packing List

The following items should be included in the box. If any items are missing please contact your supplier.

1	x	Accessory note
1	x	Quick Start Guide

Introduction

HDR-60 supports 2.5" HDD. Recording time depends on HDD's size. For 120GB HDD, HDR-60 can record 19hrs with 35Mbps bandwidth & MPEG2 format. In addition, HDR-60 supports USB2.0 & SATA interface. That means you can finish editing without card reader.

HDR-60 complies with NTFS file system. There would be no problem if you need to record big file. In addition, HDR-60 can store MXF file format. It helps on equipment's effect & saving producing time.

Features

- USB & SATA interface
- SD/HD input format support
 - SD format: 480i, 576i
 - HD format: 1080i 50/59.94/60, 1080p 23.976/24, 720p 50/59.94/60
- SD/HD recording format
 - SD bit rate : 8Mbps, 15Mbps, 25Mbps, 30Mbps, 50Mbps
 - HD bit rate : 10Mbps, 25Mbps, 35Mbps, 65Mbps, 100Mbps, 120Mbps, 125Mbps
- NTFS file system support
- 4 : 2 : 2 sample rate with 8bit video recording
- SD-SDI \ HD-SDI input & loop thru
- MXF OP1A file format compatible with most nonlinear editing program
- 4 sets Mini XLR analog audio input. 8 channel audio can be embedded in SDI Video.
- Time code input & Time code output
- 99 Bins for recording
- Support RS-232 & GPI control
- Gen-lock function support

Connections & Controls

Front Panel

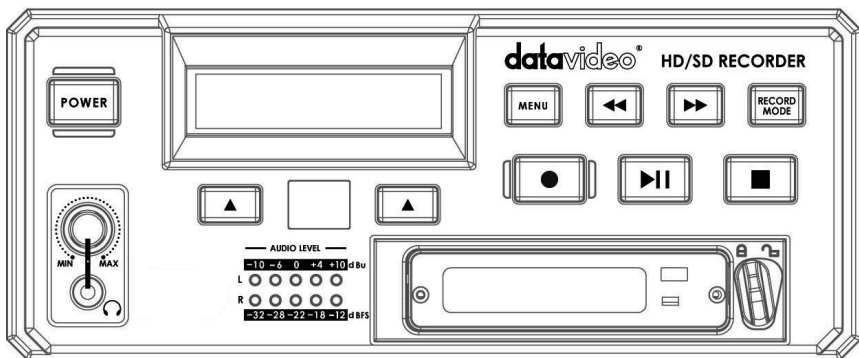

Power On / Off Button. This is a soft power on / off button which powers the unit on from a state of standby; the main power on / off switch is on the rear panel.



Display Panel. Displays the status of the HDR-60. The display will show Bin Number, time code, or if the Menu Button is pressed the Menu Display.



Menu Button. This calls up the menu display which is navigated using the Fwd / Rew Buttons and Previous / Next Buttons.



Fwd / Rew Buttons. In playback mode these buttons will operate as Fast Forward and Rewind Buttons.



Record Mode Button. When you want recording press the Record Mode button first.

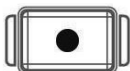

Record Button. Puts the HDR-60 into record mode. To start recording press the Record Button and Play Button simultaneously.

N.B. Unit will not record if no video signal is present.



Play / Pause Button. Starts playback of a bin, or pauses playback of a bin- status will be displayed on the Display Panel.



Stop Button. Stops playback or record.



Previous / Next Buttons. These buttons navigate up and down between recorded bins and menu options.



Audio Level Adjustments allow you to adjust the headphone volume. Stereo mini jack plug for stereo headphone. The headphone volume is controlled by the Audio Level Adjustments.

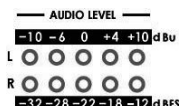

The Audio Input Level LEDs show the audio input levels from the incoming source.

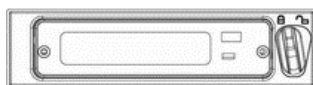

2.5" Removable HDD Rack, SATA & USB interface connecting to a PC for file transfer.

Rear Panel

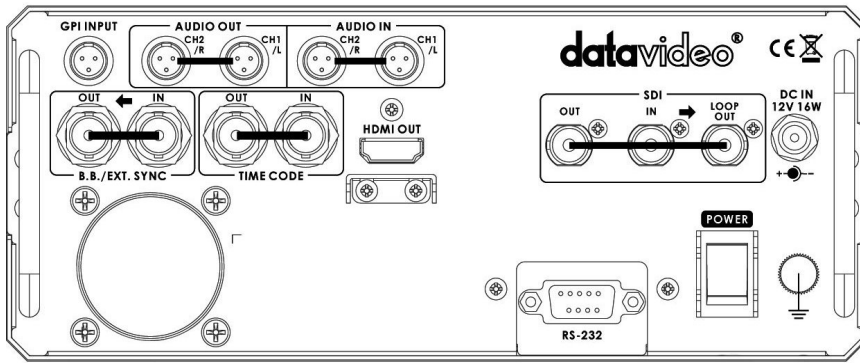

GPI INPUT



The GPI socket can be used for simple external control. The HDR-60 can accept pulse or level trigger inputs, which can trigger record or playback and pause commands.

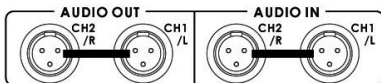

Mini XLR inputs and Outputs for Balanced Audio Connection.

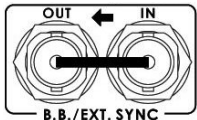

Black Burst input/ output Can be used as a video reference source when synchronization other devices to the HDR-60.

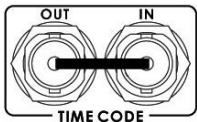

HDR-60 can select time code source from internal or external, when you set time code source from external, you can connect to this input port.

HDMI OUT



HDMI Out Ports. Ports for connecting to HDMI external devices.

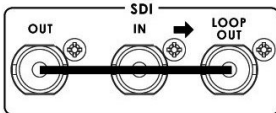

HD- SDI input, output and pass-through output connectors. 4:2:2 SDI Video data supports SMPTE 292M standard at 1.5Gbps. SDI transfers professional level video signals and it's can connect to long distance transmission systems.

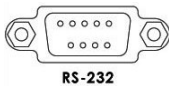

RS-232

RS-232/422 user selectable remote control (select in menu)



DC In Socket. Connect the supplied 12V PSU to this socket. The connection can be secured by screwing the outer fastening ring of the DC In plug to the socket.



Power On/Off Switch. Switches the power On / Off.



Grounding Terminal. When connecting this unit to any other component, make sure that it is properly grounded by connecting this terminal to an appropriate point. When connecting, use the socket and be sure to use wire with a cross-sectional area of at least 1.0 mm².

Powering On

Connect the HDR-60 power supply to the DC In socket. Ensure the power cable is connected to a suitable mains socket.



Press the Power Button until it lights up

The LCD display panel should show the bin display appear and the HDR-60 is ready

MENU Key Function

TOOL

FIRMWARE REVISION

Display the Rev No. and Firmware Revision, CODEC, HOST REV, of the HDR-60



Press the (MENU) button into the menu mode



Press the (ENTER) button into the **TOOL** menu



Press the (NEXT) button to select the **FIRMWARE REVISION** menu



Press the (ENTER) button into the **FIRMWARE REVISION** menu



Press the (NEXT) button to see other Firmware Revision.

ERASE THIS BIN

ERASE THIS BIN is used for deleting individual bins from the HDR-60.



Press the (MENU) button into the menu mode



Press the (ENTER) button into the **TOOL** menu



Press the (ENTER) button into the **ERASE THIS BIN** menu





Press the (ENTER) button to erase the selected bin - The bin duration will return to 00:00:00:00

FORMAT MEDIA

Format Media will remove all bins from the hard drive.

Press the  (MENU) button into the menu mode

Press the  (ENTER) button into the **TOOL** menu

Press the  (NEXT) button to select the **FORMAT MEDIA** menu

Press the  (ENTER) button into the **FORMAT MEDIA** menu

Press the  (FORMAT) Button to erase the selected bin - The bin duration will return to 00:00:00:00

After a few seconds the HDR-60 will return to normal.

UPGRADE FIRMWARE

Update the HDR-60 firmware step:

1. Select the FORMAT MEDIA to format 2.5" HDD
2. Turn off the HDR-60 power
3. Move out the 2.5"HDD of HDR-60
4. Connect it to your computer
5. Rename FW file to "flash.bin"
6. Copy the firmware update file to the root directory, level where all bin folders appear.
7. Insert the 2.5" HDD in the HDR-60 and select the UPGRADE FIRMWARE option and follow the instructions

WARNING: Wait until you see

UPGRADE FINISH!
PLEASE POWER CYCLE!

then reboot system.

Press the  (MENU) button into the menu mode

Press the  (ENTER) button into the **TOOL** menu

Press the  (NEXT) button to select the **UPGRADE FIRMWARE** menu

Press the  (ENTER) button to upgrade the HDR-60 firmware

MAKE MEDIA FILES

This operation prepares the recorded content to be seen by a computer by building the file wrappers around the recorded content and emulating the computer's operating file system.

The operating system environment is previously set to either NTFS. When there is recording content, this action needs to be taken before connecting as an HDD.

Press the  (MENU) button into the menu mode

Press the  (ENTER) button into the **TOOL** menu

Press the  (NEXT) button to select the **MAKE MEDIA FILES** menu

Press the  (ENTER) button to make media files

SETUP

RECORD SETUP

Press the  (MENU) button into the menu mode

Press the  (NEXT) button to select the **SETUP** menu

Press the  (ENTER) button into the **SETUP** menu

Press the  (ENTER) button into the **RECORD SETUP** menu

Press the  (ENTER) button into the **SET HD ENCODE FORMAT / SET SD ENCODE FORMAT / SET SD ASPECT RATIO / TIME-LAPSE SETUP / PWR ON AUTO-RECORD** menu

SET HD ENCODE FORMAT

Setting the HD LONG GOP or HD I FRAME ONLY (encode Intra frame only).

SET SD ENCODE FORMAT

Setting the SD LONG GOP or SD I FRAME ONLY (encode Intra frame only).

SET SD ASPECT RATIO

Sets the SD aspect ratio to 16:9 or 4:3

TIME-LAPSE SETUP

Setting the TIME-LAPSE ON/ OFF

Setting the TIME-LAPSE FRAME (1 frame / 1 sec)

Setting the TIME-LAPSE CYCLE (y frame per x sec)

PWR ON AUTO-RECORD

Setting the POWER ON AUTO-RECORDS mode on / off

PLAY SETUP

Press the  (MENU) button into the menu mode

Press the  (NEXT) button to select the **SETUP** menu

Press the  (ENTER) button into the **SETUP** menu

Press the  (NEXT) button to select the **PLAY SETUP** menu

Press the  (ENTER) button into the **PLAY SETUP** menu

Press the  (ENTER) button into the **SET LOOP PLAY / POWER ON AUTO-PLAY / SET GEN LOCK** menu

SET LOOP PLAY

Setting the LOOP PLAY mode on / off

POWER ON AUTO-PLAY

Setting the POWER ON AUTO-PLAY mode on / off

SET GEN LOCK

Setting the GEN LOCK mode on / off

SYSTEM SETUP

Press the  (MENU) button into the menu mode

Press the  (NEXT) button to select the **SETUP** menu

Press the  (ENTER) button into the **SETUP** menu

Press the  (NEXT) button to select the **SYSTEM SETUP** menu

Press the  (ENTER) button into the **SYSTEM SETUP** menu

Press the  (ENTER) button into the **SET AUDIO SOURCE / SET TIMECODE DISPLY / SET GPI / SET AUDIO MONITOR / SET REMOTE CONTROL / SET LONG TIME STOP / DATE & TIME SETUP** menu

SET AUDIO SOURCE

Setting the AUDIO SOURCE (CH1&2) from SDI or analog input

SET TIMECODE DISPLY

TIMECODE SELECT - Setting the TIME CODE DISPLAY from internal or external

SET TIME CODE RUN - Setting the TIME CODE running at recording or free running

SET GPI

SET GPI MODE - Setting the GPI MODE at PULSE or LEVEL

GPI START TRIGGER - Setting the GPI START TRIGGER for recording or playing

SET AUDIO MONITOR

Setting the AUDIO MONITOR display channel 1&2, 3&4, 5&6 or 7&8

SET REMOTE CONTROL

Setting the REMOTE CONTROL from RS-232 or RS-422

SET LONG TIME STOP

Setting the HOLD 1 SEC TO STOP function on / off

DATE & TIME SETUP

Setting the DATE & TIME

SAVE SETUP

Press the  (MENU) button into the menu mode

Press the  (NEXT) button into the **SETUP** menu

Press the  (ENTER) button into the **SETUP** menu

Press the  (NEXT) button to select the **SAVE SETUP** menu

Press the  (ENTER) button into the **SAVE SETUP** menu

Press the  (NEXT) button to select save to the **USER #1** or **USER #2**

Press the  (ENTER) button to confirm your select

RECALL SETUP

Press the  (MENU) button into the menu mode

Press the  (NEXT) button into the **SETUP** menu

Press the  (ENTER) button into the **SETUP** menu

Press the  (NEXT) button to select the **RECALL SETUP** menu

Press the  (ENTER) button into the **RECALL SETUP** menu

Press the  (NEXT) button to select load **FACTORY D / USER #1** or **USER #2** file.

Press the  (ENTER) button to confirm your select

STATUS

Press the  (MENU) button into the menu mode

Press the  (NEXT) button into the **STATUS** menu

Press the  (ENTER) button into the **STATUS** menu

Press the  (NEXT) button to see the **FILE / BIT-RATE / INPUT** (When **RECORD MODE** on) / **RECORDER** status

How to Assemble 2.5" HDD in Removable Rack

1. Remove two screws from the 2.5" removable HDD rack rear cover then pull out the PCB

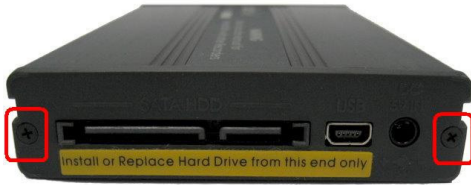

2. Assemble four screws to fasten 2.5" HDD on PCB

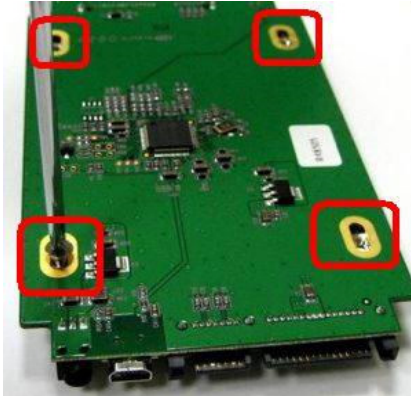

3. Push PCB into the HDD rack



4. Assemble two screws to fasten HD rack rear cover



5. Push 2.5" HDD Removable rack into HDR-60 then turn button to left lock the rack



HDR-60/70 RS-232/422 Control Command

Revised on 11/14/2012

Command	Name	Response Data
	Common Transport Control	
20h, 00h, 20h	Stop	10h, 01h, 11h
20h, 01h, 21h	Play	10h, 01h, 11h
20h, 02h, 22h	Record	10h, 01h, 11h
20h, 10h, 30h	Fast Forward	10h, 01h, 11h
20h, 20h, 40h	Fast Rewind	10h, 01h, 11h
20h, 14h, 34h	Frame Step Forward	10h, 01h, 11h
20h, 24h, 44h	Frame Step Reverse	10h, 01h, 11h
21h, 11h, nnh, csum	Jog Forward	10h, 01h, 11h
21h, 12h, nnh, csum	Variable Forward	10h, 01h, 11h
21h, 13h, nnh, csum	Shuttle Forward	10h, 01h, 11h
21h, 21h, nnh, csum	Jog Reverse	10h, 01h, 11h
21h, 22h, nnh, csum	Variable Reverse	10h, 01h, 11h
21h, 23h, nnh, csum	Shuttle Reverse	10h, 01h, 11h
21h, 13h, 00h, 32h	Play Pause	10h, 01h, 11h
	Vender Unique Control	
21h, F0h, nn, csum	Select Bin and Play	10h, 01h, 11h
21h, F7h, nn, csum	Select Bin	10h, 01h, 11h
	Common System Control	
00h, 11h, 11h	Device Type Request	Device Type
	Vender Unique System Control	
01h, 10h, 30h, 41h	Fast Forward	10h, 01h, 11h
01h, 20h, 40h, 61h	Rewind	10h, 01h, 11h
01h, F1h, 00h, F2h	Next (Right key)	10h, 01h, 11h
01h, F1h, 01h, F3h	Next Bin	10h, 01h, 11h
01h, F1h, 02h, F4h	Next Clip	10h, 01h, 11h
01h, F1h, 03h, F5h	Next Frame	10h, 01h, 11h
01h, F1h, 04h, F6h	Drop Mark	10h, 01h, 11h
01h, F2h, 00h, F3h	Previous (Left Key)	10h, 01h, 11h
01h, F2h, 01h, F4h	Previous Bin	10h, 01h, 11h
01h, F2h, 02h, F5h	Previous Clip	10h, 01h, 11h
01h, F2h, 03h, F6h	Previous Frame	10h, 01h, 11h
02h, F5h, 08h, 00h, FFh,	Disable Loop Play	10h, 01h, 11h
02h, F5h, 08h, 01h, 00h	Enable Loop Play	10h, 01h, 11h
	Sense Control	
61h, 0Ch, 04h, 71h	Start Time code Sense	74h, 00h, TC(3:0), csum
61h, 20h, 0Fh, 90h	Status Sense	7Fh, 20h, [15 bytes], csum
	Vender Unique Sense Control	
61h, 0Dh, 04h, 72h	Current Frame Offset	74h, 00h, [4 bytes] , csum
61h, F2h, 05h, 58h	Firmware Revision Sense	77h, F2h, 05h, [7 bytes] , csum
61h, F2h, 07h, 5Ah	Capacity Sense	75h, F2h, 07h, [5 bytes, csum

Error CMD Response: 11h, 12h, 23h

Status Sense Control Command Response Bytes

Status Byte	Bit 7	Bit 6	Bit 5	Bit 4	Bit 3	Bit 2	Bit 1	Bit 0
0	Busy	0	Cartridge Out	0	0	0	0	Local enable
1	0	0	Stop	0	Rewind	Fast Forward	Record	Play
2	0	0	0		0	Reverse	Still (Pause)	0
3	0	0	0	0	Audio in	0	Video in	0
4	1	0	0	0	1	0	0	0
5	0	0		0	0	0	0	0
6	0	0	0	0	0	0	0	0
7	0	0	0	0	0	0	0	0
8	0	0	Near End of Disk (panic mode)	End of disk	0	0	0	0
9	0	0	0	0	0	0	0	0
10	BIN7	BIN6	BIN5	BIN4	BIN3	BIN2	BIN1	BIN0
11	File Length byte 0	FL0	FL0	FL0	FL0	FL0	FL0	FL0
12	Length Byte 1	FL1	FL1	FL1	FL1	FL1	FL1	FL1
13	0	0	0	0	0	0	0	0
14	Length Byte 2	FL2	FL2	FL2	FL2	FL2	FL2	FL2
15	Length Byte 3	FL3	FL3	FL3	FL3	FL3	FL3	FL3

Dimension

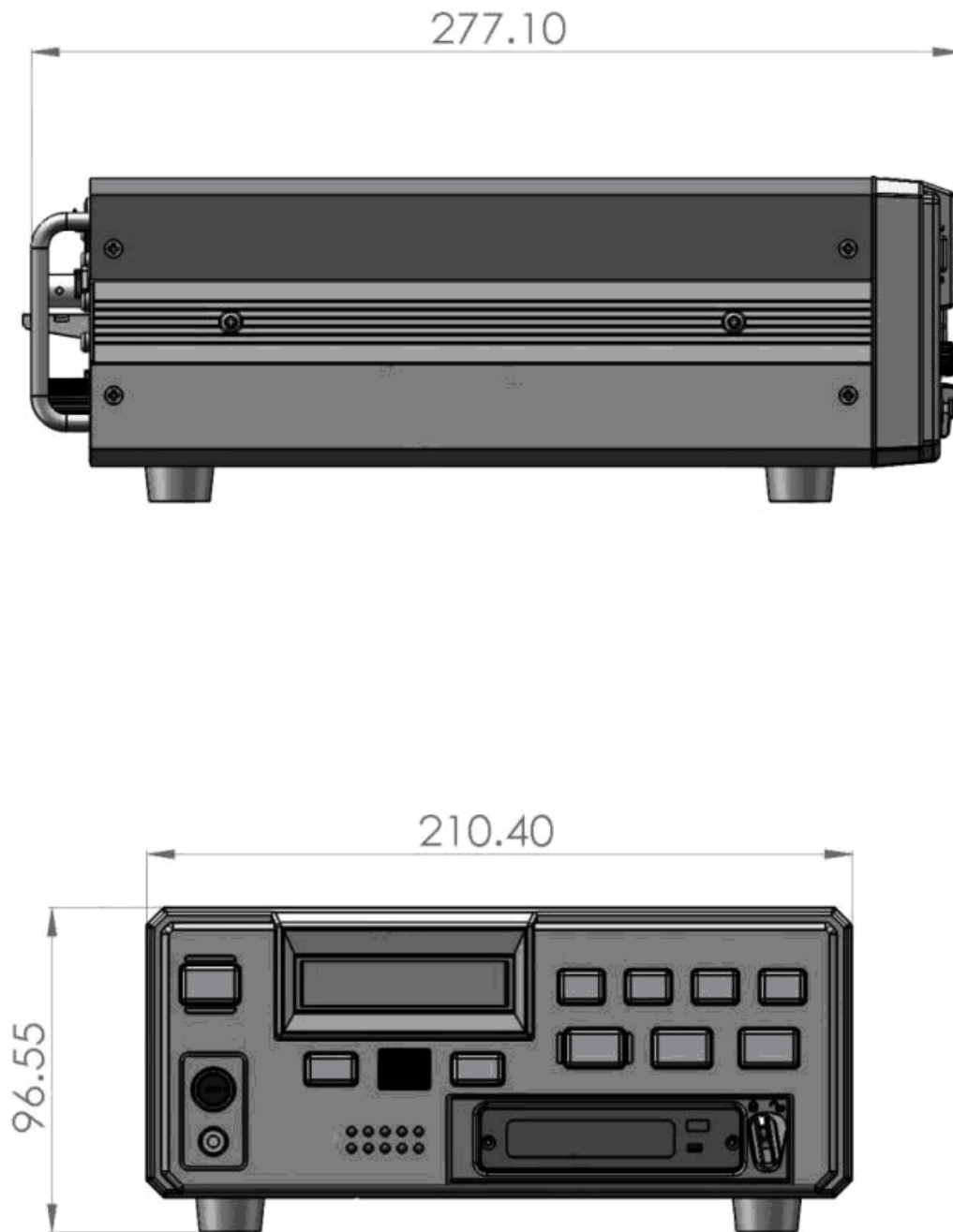

Specifications

HDD Size	HDD: 250/320/500/750 GB SSD: 120GB/240 GB	
Video Input	HD/SD-SDI	
	Time code	
Video Output	HD/SD-SDI	
	HDMI	
Time code IN/OUT	Time code	
Audio Input	Balance Audio Analog 2-CH	
	HD/SD-SDI (8CH)	
Audio Output	Balance Audio Analog 2-CH	
	HD/SD-SDI (8CH)	
	HDMI / 4 CH	
Headphone	REC / PLAY	
File Format	MXF OP1A	
File System	NTFS	
Misc.	RS-232/RS-422	
	Record BIN: 99 Bins@99Clips/Bin	
	Pre-record(I-frame only; Maximum 4 sec)	
	Power On Record	
	Power On Play	
	Timelapse Rec (I-frame only)	
	Reference In/Out IN & Loop through, Black Burst and Tri-Level signal	
Video Format	SD 50/59.94 Hz	HD 720P@50/59.94/60 1080i@50/59.94/60 1080P@23.976/24
	Color Format (4:2:0/4:2:2)	
Codec	MPEG2 Long GOP	
	MPEG2 Long GOP HD 1. 10Mbps 4:2:0 1440x1080/1280x720 2. 25Mbps 4:2:0 1440x1080/1280x720 3. 35Mbps 4:2:2 1920x1080/1280x720 4. 65Mbps 4:2:2 1920x1080/1280x720 5. 120Mbps 4:2:2 1920x1080/1280x720	MPEG2 Long GOP SD 1. 8Mbps 4:2:0 720x480/720x576 2. 15Mbps 4:2:2 720x480/720x576 3. 30Mbps 4:2:2 720x480/720x576 4. 50Mbps 4:2:2 720x480/720x576
	MPEG2 i-Frame Only	
	MPEG2 I-Frame Only HD 1. 100Mbps 4:2:2 1920x1080/1280x720 2. 125Mbps 4:2:2 1920x1080/1280x720	MPEG2 I-Frame Only SD 1. 25Mbps 4:2:2 720x480/720x576 2. 50Mbps 4:2:2 720x480/720x576
PWR Consumption	12V / 1.5A (16W)	

Service & Support

It is our goal to make your products ownership a satisfying experience. Our supporting staff is available to assist you in setting up and operating your system. Please refer to our web site www.datavideo.com for answers to common questions, support requests or contact your local office below.

Datavideo Global Website: www.datavideo.com

Datavideo Corporation

Tel: +1 562 696 2324	Fax: +1 562-698-6930	E-Mail: contactus@datavideo.us
----------------------	----------------------	--

Datavideo Technologies Europe BV

Tel: +31-30-261-96-56	Fax: +31-30 261-96-57	E-Mail: service@datavideo.nl
-----------------------	-----------------------	--

Datavideo UK Limited

Tel: +44 1457 851 000	Fax: +44 1457 850 964	E-Mail: sales@datavideo.co.uk
-----------------------	-----------------------	--

Datavideo Technologies Co., Ltd

Tel: +886 2 8227 2888	Fax: +886-2-8227-2777	E-mail: service@datavideo.com.tw
-----------------------	-----------------------	--

Datavideo Technologies China Co., Ltd

Tel: +86 21-5603 6599	Fax: +86 21-5603 6770	E-mail: service@datavideo.cn
-----------------------	-----------------------	--

Datavideo Technologies (S) PTE LTD

Tel: +65-6749 6866	Fax: +65-6749 3266	E-mail: service@datavideo.sg
--------------------	--------------------	--

Datavideo HK Limited.

Tel: +852 2833 1981	Fax: +852-2833-9916	E-mail: info@datavideo.com.hk
---------------------	---------------------	--

Datavideo France

Tel: +33 1 60 37 02 46	Fax: +33 1 60 37 67 32	E-Mail: info@datavideo.fr
------------------------	------------------------	--

Datavideo India

Tel: +91-0120-2427337	Fax: +91-0120-2427338	E-Mail: sales@datavideo.in
-----------------------	-----------------------	--

All the trademarks are the properties of their respective owners.
Datavideo Technologies Co., Ltd. All rights reserved 2018