

KONA

Professional Performance, Unparalleled Reliability



AJA[®]
VIDEO SYSTEMS

Because it matters.™

KONA



KONA 3G



KONA LHi

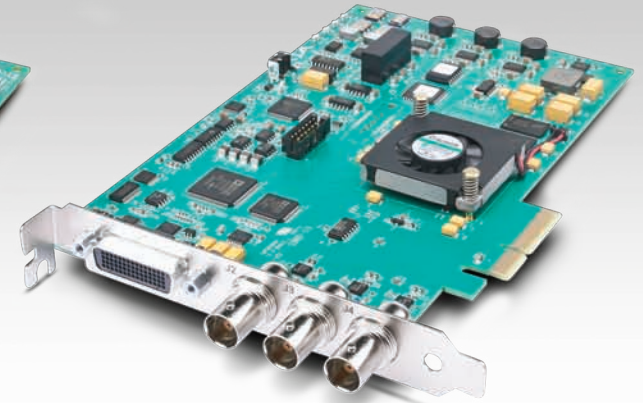

KONA LHe Plus

AJA's KONA family of I/O cards deliver a complete range of performance and connectivity options to fit any budget or workflow from standard definition through to 4K.

Professional Performance, Unparalleled Reliability

Built for the exacting demands of video professionals, KONA cards offer the highest quality video and audio I/O with a range of feature sets tuned for your workflow.

Whatever your post production process, KONA capture, display and mastering solutions for SD, HD, 3G, Dual Link HD, 2K and 4K on a Mac or PC, provide the best engine for your creative process.

In a world of myriad HD standards, SD, 2K, stereoscopic 3D and growing 4K workflows, KONA cards offer maximum connectivity like 3G/HD/SD SDI, Component, and HDMI-along with the flexibility of AJA's high-quality conversion capability.

No more rendering for raster resizing, KONA's superior 10-bit hardware-based up/cross/down conversion offers you the ability to ingest to the resolution of your project while displaying and mastering live simultaneously to HD and SD as your needs require.

At AJA we understand that creative professionals have a range of software applications and platforms they prefer and need to work with. Using AJA's industry-leading Mac and PC drivers and custom application plug-ins, KONA cards support the broadest range of creative software. Pick your applications of choice and KONA connects it to your world.

Built to the exacting standards of all AJA hardware, KONA cards are backed by our world-class support network, 3-year international warranty and advanced exchange service.

Software Compatibility

KONA cards are cross-platform and compatible with a wide range of professional Mac and PC software applications.



Mac software

AJA KONA for Mac drivers are optimized for each software application that is supported. Advanced AJA hardware capabilities are controlled easily at-a-glance within the native application environment by using AJA's free application plug-ins.

AJA hardware is also being utilized in live streaming environments, allowing external video signals to be seamlessly captured into the streaming software.

Some of the supported applications include:

- Adobe Premiere® Pro
- Adobe After Effects®
- Adobe Photoshop®
- Avid® Media Composer® 6, Symphony® 6, and NewsCutter® 10
- Apple Final Cut Pro X
- Autodesk Smoke for Mac
- Telestream Wirecast

Powerful AJA utilities, Easy Setups, and a suite of plug-ins round out the Mac environment providing support for all popular application workflows.



PC software

KONA for PC software allows Windows to access the hardware power of your KONA within major editing and graphics applications. Other software vendors, such as popular live streaming applications, have also integrated support for KONA in their own PC applications through direct collaboration with AJA.

Choose the right KONA card for any format you need. You can playback and master material, at a variety of frame rates, on a high-resolution monitor or digital projector.

Supplied AJA plug-ins integrate your KONA card into a variety of graphics/visual-effects software applications to make operations even easier to use. Using AJA plug-ins, sophisticated features appear as if they were native to the software application user interface.

Some of the supported applications include:

- Adobe Premiere® Pro
- Adobe After Effects®
- Adobe Photoshop®
- Avid® Media Composer® 6, Symphony® 6, and NewsCutter® 10
- Sony® Vegas®
- Eyeon Fusion®
- Telestream Wirecast

Software Compatibility



KONA 3G

KONA LHi

KONA LHe Plus

	KONA 3G	KONA LHi	KONA LHe Plus
Apple FCP X	Mac	Mac	Mac
Apple Motion	Mac	Mac	Mac
Adobe Premiere Pro	Mac/PC	Mac/PC	Mac/PC
Adobe After Effects	Mac/PC	Mac/PC	Mac/PC
Adobe Photoshop	Mac/PC	Mac/PC	Mac/PC
Adobe Speedgrade	Mac/PC	Mac/PC	Mac/PC
Avid Media Composer	Mac/PC	Mac/PC	Mac/PC
Avid Symphony	Mac/PC	Mac/PC	Mac/PC
Avid NewsCutter	Mac/PC	Mac/PC	Mac/PC
Autodesk Smoke On Mac	Mac	—	—
Drastic Media NXS	PC	PC	PC
Sony Vegas	PC	PC	PC
Eyeon Fusion 64 bit	PC	PC	PC
The Foundry Nuke	Mac/PC	Mac/PC	Mac/PC
Media 100	Mac	Mac	Mac
Softron	Mac	Mac	Mac
Gallery	Mac	Mac	Mac
Building4Media	Mac/PC	Mac/PC	Mac/PC
Bug.tv	Mac	Mac	Mac
ToolsOnAir	Mac	Mac	Mac
Telestream Wirecast	Mac/PC	Mac/PC	Mac/PC

* For more information on the latest Software Compatibility please visit: <http://www.aja.com/en/products/kona/>

Features Comparison Chart

KONA capture cards are available in three models to meet your workflow needs, all built with AJA's reputation for quality, reliability and support.



KONA 3G

KONA LHi

KONA LHe Plus

SD (NTSC and PAL)	yes	yes	yes
HD (720p, 1080i, 1080sf)	yes	yes	yes
2K (2048 x 1556, 2048 x 1080) Dual Link HD, 2K HSDL, 4:4:4 RGB	yes	2K x 1080 video at 4:2:2, non-RGB	-
4K (3840 x 2160, 4096 x 2160) YCbCr and RGB colorspaces	yes	-	-
3G SDI	yes	yes	-
HDMI	HDMI 1.4a output	HDMI 1.3a input/output	-
HD to SD Down-conversion (10-bit, in hardware)	yes	yes	yes
SD to HD Up-conversion (10-bit, in hardware)	yes	yes	-
HD to HD Cross-conversion (1080 to/from 720, 10-bit, in hardware)	yes	yes	-
12-bit Analog Video (component, composite, and Y/C)	output SD/HD	input/output SD/HD	input/output SD/HD
10-bit SDI Digital Video (BNC)	input/output SD/HD/3G	input/output SD/HD/3G	input/output SD/HD
HD Video+Key	yes	-	-
Analog Audio (balanced XLR)	-	input/output 2-channel	input/output 2-channel
AES Digital Audio	8-ch I/O w/cable, 16-ch I/O w/K3G-Box	input/output 2-channel	input/output 2-channel
Embedded SDI Audio (via BNC)	input/output 16-channel	input/output 8-channel	input/output 8-channel
Professional Genlock	yes	yes	yes
LTC Input/Output	yes	LTC input (shared with reference BNC)	-
RS-422 Machine Control	yes	yes	yes
1RU Breakout Box (optional)	yes	yes	yes
3-year AJA Warranty with Advanced Exchange	yes, included	yes, included	yes, included

KONA^{3G}



Only \$1,995 US MSRP*

[Find a Reseller](#)

Unparalleled Professional Performance

Top-of-the-line capabilities and quality make KONA 3G the go-to desktop I/O card.

Ready for today's workflows and those of the future, KONA 3G gives video professionals unrivalled features and the highest standards in quality and performance.

KONA 3G is a video and audio desktop I/O card that provides video professionals with unparalleled features for handling everything from SD to HD, 2K and 4K with full 10-bit uncompressed clarity. With a broadcast quality up/down/cross converter and the ability to work in 3D, KONA 3G has the power for the work you do today and into the future.

KONA 3G offers users a single, powerful card with support for 4:2:2 and 4:4:4 color spaces to provide the highest quality for your images. The futureproof architecture means you can easily work with HD and 2K now and switch to working at 4K resolution when the need arises without the requirement for new hardware.

KONA 3G supports Dual Link 4:4:4 HD-SDI, with full-bandwidth 4:4:4 RGB at 10-bits for 1080i, 1080p, 1080PsF and 720p formats. KONA 3G can also convert between 4:4:4 and 4:2:2 formats for single link HD-SDI monitoring and output.

For SDI video, KONA 3G features two 3G/HD/SD inputs and two outputs. HDMI 1.4a monitoring output, LTC I/O, Genlock input and configurable 3 x BNC SD/HD analog video output. Switch KONA 3G into 4K mode and all four BNC connections can be used for 4K capture or output.

KONA 3G's extensive 4K support allows output directly from editing systems to 4K projectors or monitors, allowing editors and clients to view full resolution 4K images as they work. This output capability enables a powerful 4K workflow that is also affordable and manageable.

The built-in up/down/cross converter brings any video to a unified resolution, simplifying workflows and eliminating the need to adjust resolution within software. KONA 3G also includes a powerful hardware downstream keyer that can place graphic files with an alpha channel, selectable color matte or the contents of the card's frame buffer over the video being input to the card.

KONA^{3G}



From SD to 4K in a single card

KONA 3G is futureproof, allowing you to easily work in HD and 2K and switch to working at 4K resolution without the need for additional or new hardware.

Leading the way for quality 4K capture, monitoring and output, KONA 3G offers 4K in both YCbCr and RGB. When 4K mode is selected, the four SDI connectors are remapped as I/O for handling the four quadrants of a 4K picture, providing support for most standard 4K formats.



Integrated AJA hardware conversion

KONA 3G features full 10-bit, broadcast-quality, motion-adaptive SD to HD up conversion, HD to HD cross conversion, HD to SD down conversion, and automatic SD/HD 12-bit component analog output.

Since all conversion functionality on the KONA 3G is hardware-based, it's available on ingest or playback.

Uniquely, the KONA 3G can cross convert 720p 23.98 to 1080PsF 23.98. Cross conversion is particularly valuable in today's multiformat HD post environment where producing pristine 720p or 1080i signals at-will helps streamline dailies and deliverables.



Extend your Connectivity

The optional K3G-Box breakout box and cables allow KONA 3G to integrate easily into rack environments, enabling quick access to all video and audio connections without having to get at the back of the tower computer. Additional K3G-Box functionality over the standard breakout cable comes in the form of eight additional AES audio channels, 2-channel RCA analog audio monitoring jacks, and looping BNC Genlock reference connectors.

Connections

K3G-BOX Breakout Box
(Optional)

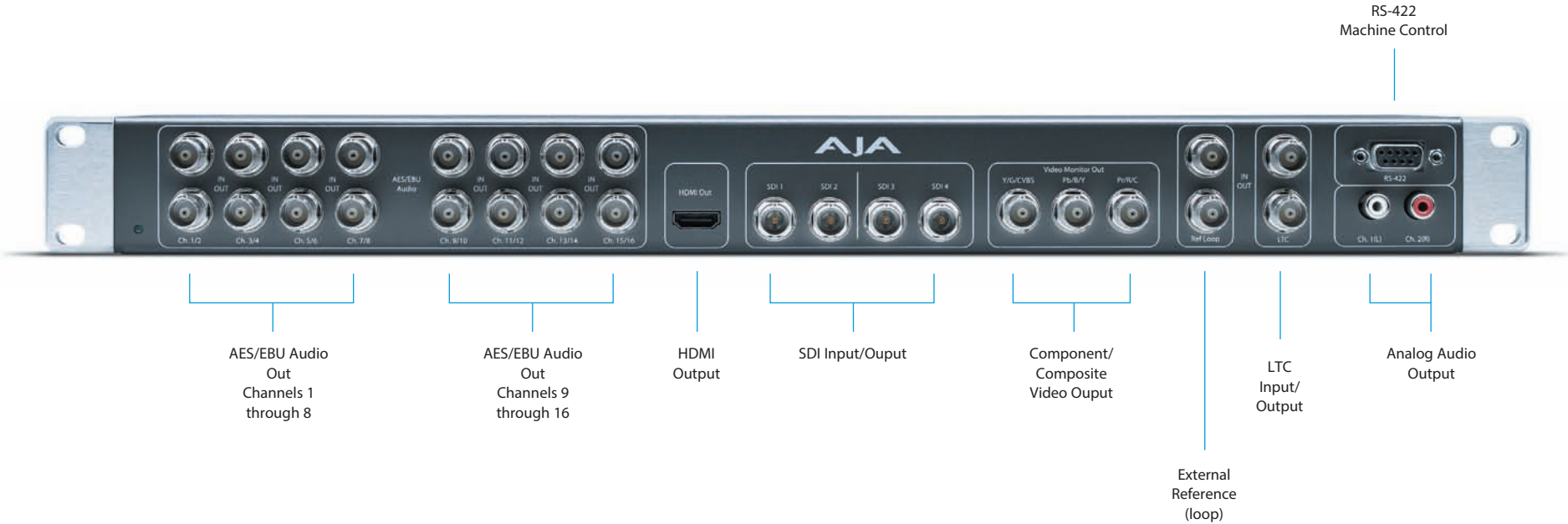

[Click here](#) ▶ For full product specifications visit www.aja.com/kona-3g/techspecs

Connections

Breakout cables
(Supplied)

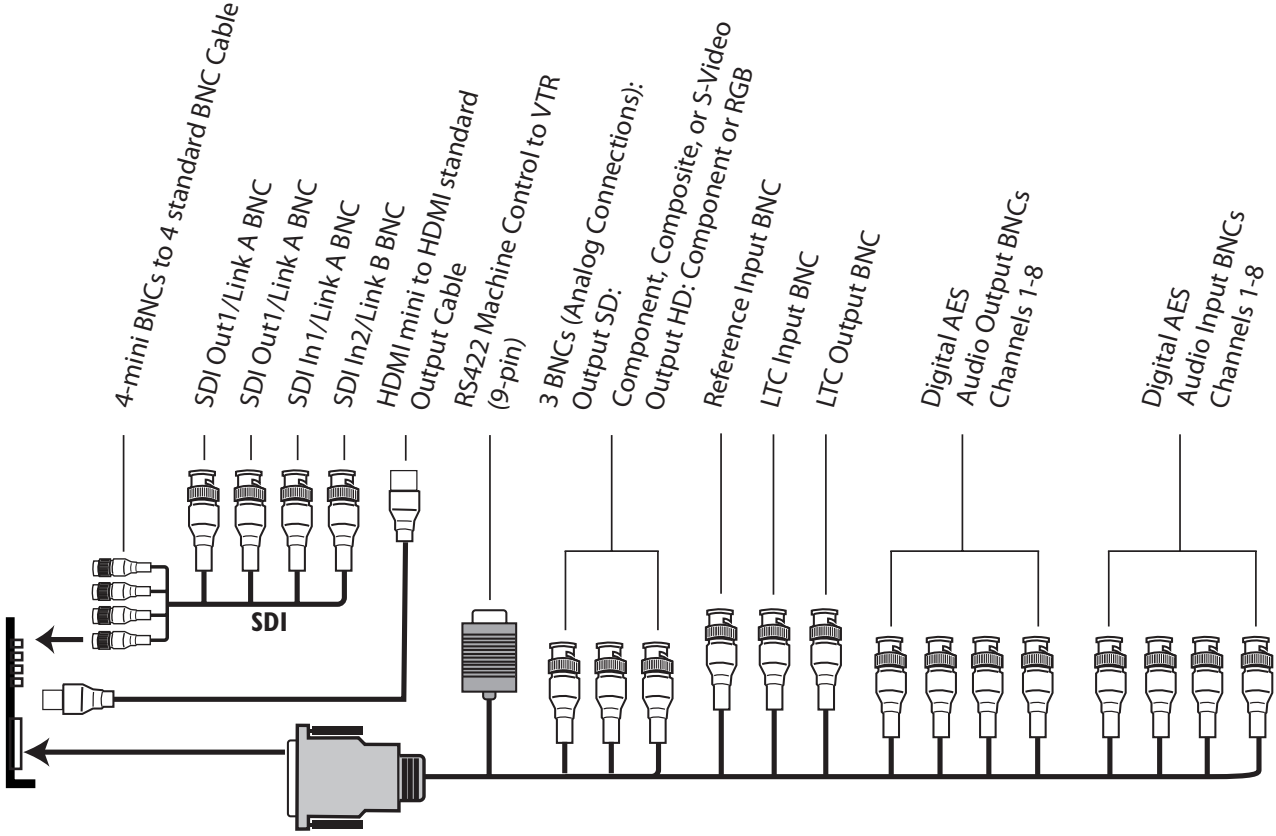

[Click here](#)

For full product specifications visit www.aja.com/kona-3g/techspecs

KONA^{3G}



Splice Finds Flexible Post Workflow with AJA KONA 3G and Avid Media Composer

"Opting for KONA 3G has also saved us on hardware costs. The fact that we can fit everything in a single workstation is great, because we don't waste space with racks."

In the heart of London's Shoreditch is the award winning post-production house - Splice. Specializing in broadcast, commercial and corporate post production, the boutique studio is home to forty full-time employees and a grand display of state-of-the art technology spanning three floors including: two Baselight grading theatres, Avid DS suites and multi channel audio recording and mixing rooms. Splice is credited for its work on such venerable UK television shows as "Jamie Oliver's 15 Minute Meals" and "The Midnight Beast," among other popular TV series and commercials.

Late this year, Splice Managing Director and Co-Founder Damian Dolniak and his team of editors began work on an 80-part series for Jamie Oliver's new show -"Jamie's 15 Minute Meals." The series was shot on ARRI Alexa cameras. Once footage was captured, his team relied heavily on a newly constructed floor in the facility housing nine Avid Media Composer suites equipped with KONA 3G capture cards, all connected to the studio's Avid ISIS shared storage solution - for post-production.

"The series is fairly heavy in terms of effects and complex sequences, and involves a lot of cross-cutting. Our new KONA 3Gs tied in nicely with the new Avid suites and worked so well - especially with the AJA KONA cards and Media Composer 6.5 ability for audio punch in and up/down/cross-conversion capabilities. They give us the ability to tackle those challenging sequences in real-time without hindering our work. The cards have also been extremely consistent in terms of output levels.", Dolniak said.

Having been a longtime user of AJA products, KONA 3G was a natural choice for Splice. "AJA products have always worked very well and continue to do so. I like AJA's approach to development and the quality of their products," shared Dolniak. "You can tell that they listen closely to the needs of the community to release products that help ease post production pains."

"The KONA 3G packages everything we need into a single solution. It integrates capture and playback, support for stereoscopic 3D and HDMI - plus all of the inputs and outputs we need," he added. "Opting for KONA 3G has also saved us on hardware costs. The fact that we can fit everything in a single workstation is great, because we don't waste rack space."

Since setting up the suites on the new floor, Dolniak has only received great feedback from editors and customers about the upgraded set up. "Our customers have been impressed with the new equipment and the growing range of footage that we can accommodate, while our editors like the fact that if someone is working in another room and they move, they'll be able to see the same thing in the other room."

Splice has a number of upcoming stereoscopic 3D projects slated for the New Year - for which it plans to leverage the stereoscopic 3D capabilities of the KONA 3G. "KONA 3G gives us the flexibility to adapt to the needs of each project. Whether HD, 2K, 4K or stereo 3D, all of our bases are covered."

[View Online](#) ▶

Workflow

KONA-powered workflows

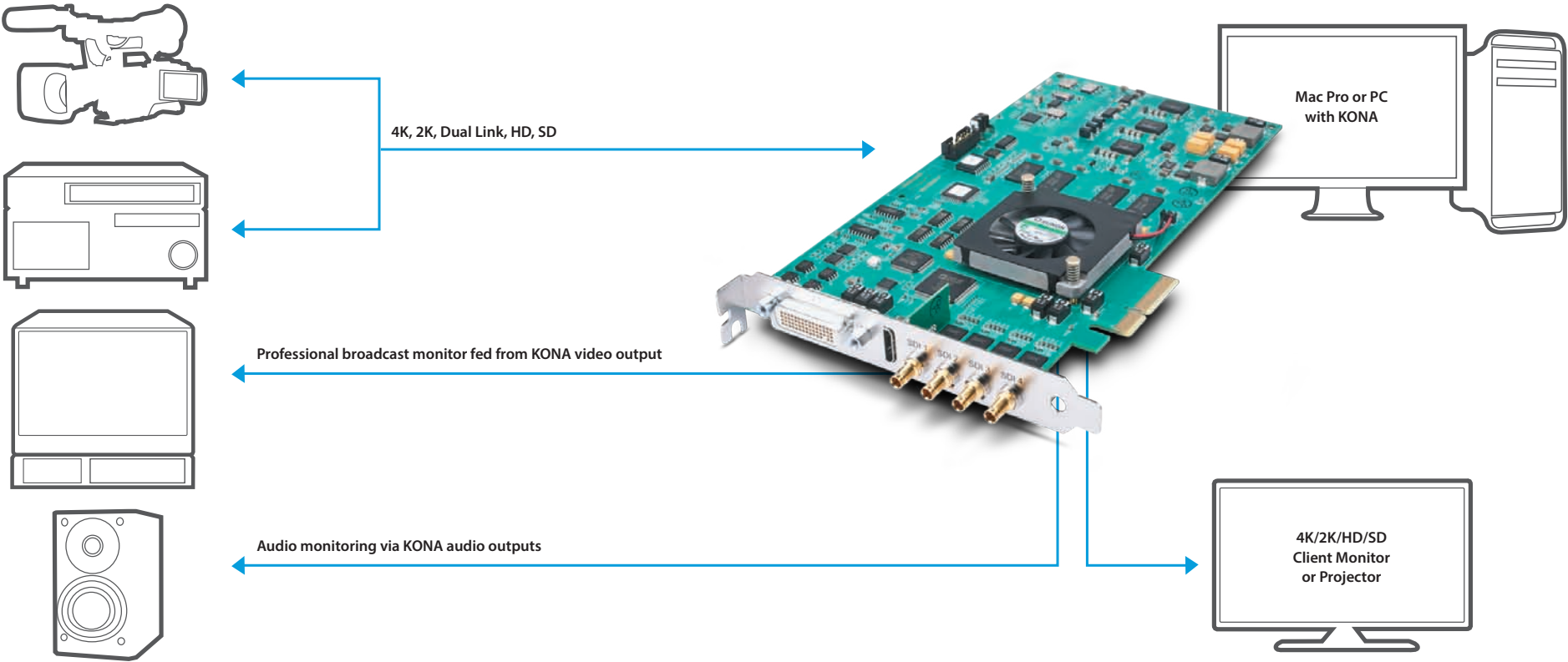

Connect your digital sources via SD/HD-SDI or HDMI to KONA for capture and editing via a wide variety of formats. Master to any Digital or Analog device through high-quality professional SDI, HDMI or Component outputs.

Tech Specs

Video Formats

- 525i 29.97
- 525i 23.98*
- 625i 25
- 720p 23.98*, 24*, 25*, 29.97*, 30*, 50, 59.94, 60
- 1080i 25, 29.97, 30
- 1080PsF 23.98, 24, 25, 29.97, 30
- 1080p 23.98, 24, 25, 29.97, 30, 50, 59.94, 60
- 2048 x 1080P 23.98, 24, 25, 29.97, 30, 50 and 60
- 2048 x 1080PsF 23.98, 24, 25
- 2048 x 1556p 15, 14.98
- 2048 x 1556PsF 15, 23.98, 24
- 3840x2160P 23.98, 24, 25
- 4096x2160P 23.98, 24, 25
- 3840x2160PsF 23.98, 24, 25
- 4096x2160PsF 23.98, 24, 25

* These formats are dependent on specific software functionality and are not normal 'over-the-wire' formats.

Video Input Digital

- 3G/SD/HD SDI, SMPTE-259/292/296/424, 8- or 10-bits
- Single Link 4:2:2 or 4:4:4 (1 x BNC)
- Dual Link HD 4:4:4 (2 x BNC)
- 2K HSDL (High Speed Data Link) 4:4:4, (2 x BNC)
- 4K/QuadHD
- 1D LUT Support

Video Output Digital

- 3G/SD/HD SDI, SMPTE-259/292/296/424
- Single Link 4:2:2 or 4:4:4 (1 x BNC)
- Dual Link HD 4:4:4, (2 x BNC)
- 2K HSDL (High Speed Data Link) 4:4:4, (2 x BNC)
- 4K/QuadHD 4:2:2 and 4:4:4
- HDMI v1.4, 30/36 bits/pixel, RGB or YUV, 2.25Gbps, SD, HD, 1080p-50/60

Video Output Analog

- Composite/S-Video (Y/C) (1 x BNC/2x BNC+adapter)
- NTSC, NTSCJ, PAL
- Component (3 x BNC)
- HD: YPbPr, RGB
- SD: YPbPr, RGB (component mode)
- SMPTE/EBU N10, Betacam 525 line, Betacam 525J, RGB
- 12-bit D/A, 8x oversampling
- +/- .2 dB to 5.0 MHz Y Frequency Response
- +/- .2 dB to 1 MHz C Frequency Response
- 5% 2T pulse response
- <1% Diff Phase
- <1% Diff Gain
- <1% ns Y/C delay inequity

Downstream Keyer

Supports graphics with alpha channel over video, matte or framebuffer, or framebuffer content over incoming video or matte.

Audio Input Digital

- 16-channel, 24-bit SDI embedded audio, 48kHz sample rate, Synchronous
- 8-channel, 24-bit AES/EBU audio, 48kHz sample rate, Synchronous or Non-synchronous, Internal sample rate conversion (via 4 x BNC on breakout cable)
- 16-channel, 24-bit AES/EBU audio, 48 kHz sample rate, Synchronous (via 8 x BNC on optional K3G-Box)

Audio Output Digital

- 16-channel, 24-bit SDI embedded audio, 48kHz sample rate, Synchronous
- 8-channel, 24-bit HDMI embedded audio, 48kHz sample rate, Synchronous
- 8-channel, 24-bit AES/EBU audio, 48kHz sample rate, Synchronous or Non-synchronous, Internal sample rate conversion (via 4 x BNC on breakout cable)
- 16-channel, 24-bit AES/EBU audio, 48 kHz sample rate, Synchronous (via 8 x BNC on optional K3G-Box)

Audio Output Analog

- 2-channel unbalanced output (via 2 x RCA jacks on optional K3G-Box)

[Click here](#)



For full product specifications visit www.aja.com/kona-3g/techspecs

(Continued on Next Page)

Tech Specs *(Continued)*

Up-Conversion

- Hardware 10-bit
- Anamorphic: full-screen
- Pillar box 4:3: results in a 4:3 image in center of screen with black sidebars
- Zoom 14:9: results in a 4:3 image zoomed slightly to fill a 14:9 image with black side bars
- Zoom Letterbox: results in image zoomed to fill full screen
- Zoom Wide: results in a combination of zoom and horizontal stretch to fill a 16:9 screen; this setting can introduce a small aspect ratio change

Down-Conversion

- Hardware 10-bit
- Anamorphic: full-screen
- Letterbox: image is reduced with black top and bottom added to image area with the aspect ratio preserved
- Crop: image is cropped to fit new screen size

Cross-Conversion

- Hardware 10-bit
- 1080i to 720p
- 720p to 1080i
- 720p to 1080PsF

SD to SD Aspect Ration Conversion

- Letterbox: This transforms SD anamorphic material to a letterboxed image.
- H Crop: Will produce a horizontally stretched effect on the image; transforms anamorphic SD to full frame
- SD Pillarbox: Will produce an image in the center of the screen with black borders on the left and right sides and an anamorphized image in the center
- V Crop: Will transform SD letterbox material to an anamorphic image.

Timecode

- LTC timecode input and output (via 1 x BNC each)

Reference Input

- Analog Color Black (1V) or Composite Sync (2 or 4V)
- Looping
- 75 ohm on optional K3G-Box, terminated on supplied breakout cable

Machine Control

- RS-422, Sony 9-pin protocol (via breakout cable or optional K3G-Box)
- 9-pin D-connector pinout is as follows:

1	GND
2	RX-
3	TX+
4	GND
5	No Connection
6	GND
7	RX+
8	TX-
9	GND
Shell	GND

[Click here](http://www.aja.com/kona-3g/techspecs) ▶ For full product specifications visit www.aja.com/kona-3g/techspecs

KONA^{LHi}



Only **\$1,495** US MSRP*

[Find a Reseller](#)

The most flexible card for analog and digital Standard and High Definition workflows.

Multi-format analog and digital I/O

KONA LHi provides the maximum compatibility for diverse workflows.

If your post-production facility works with a wide variety of formats, frame rates and audio/video sources, the KONA LHi provides the connectivity you need, bridging the gap between analog devices and the latest 3G SDI and HDMI enabled products to provide editing, monitoring and mastering of professional quality video in an affordable, powerful, easy to use product.

KONA LHi features full 10-bit, broadcast quality, motion-adaptive SD to HD up-conversion, HD to HD cross-conversion, HD to SD down-conversion, and automatic HD/SD 12-bit component analog output. Since KONA LHi's conversions are hardware-based, they are available all the time - during ingest or playback. Outputs can be configured independently allowing you to have simultaneous HD and SD output - or two different types of HD: 720 or 1080 - output at the same time via cross-conversion.



Utilize the KLHi-BOX Breakout Box to easily integrate KONA LHi into rackmount environments.

Connecting to everything from an HDMI enabled camera to an HD-SDI VTR, KONA LHi offers a full host of no-compromise features, including 10-bit or 8-bit uncompressed video, 2-channel AES digital audio and 8-channel SDI embedded digital audio, analog composite or S-video or SD/HD component video I/O, 2-channel balanced analog audio I/O, and broadcast-quality hardware-based up/down/cross-conversion for flexible SD and HD post production. KONA LHi supports a full HDMI workflow with 10-bit 'deep color' output for the best image quality possible. HDMI signals can also be converted to SDI for use in more professional environments.

In addition to a full set of video and audio I/O, KONA LHi can lock to external reference signals, accept timecode in and out and control a variety of tape decks via the industry standard RS-422 9-pin connection.

Workflow

KONA-powered workflows

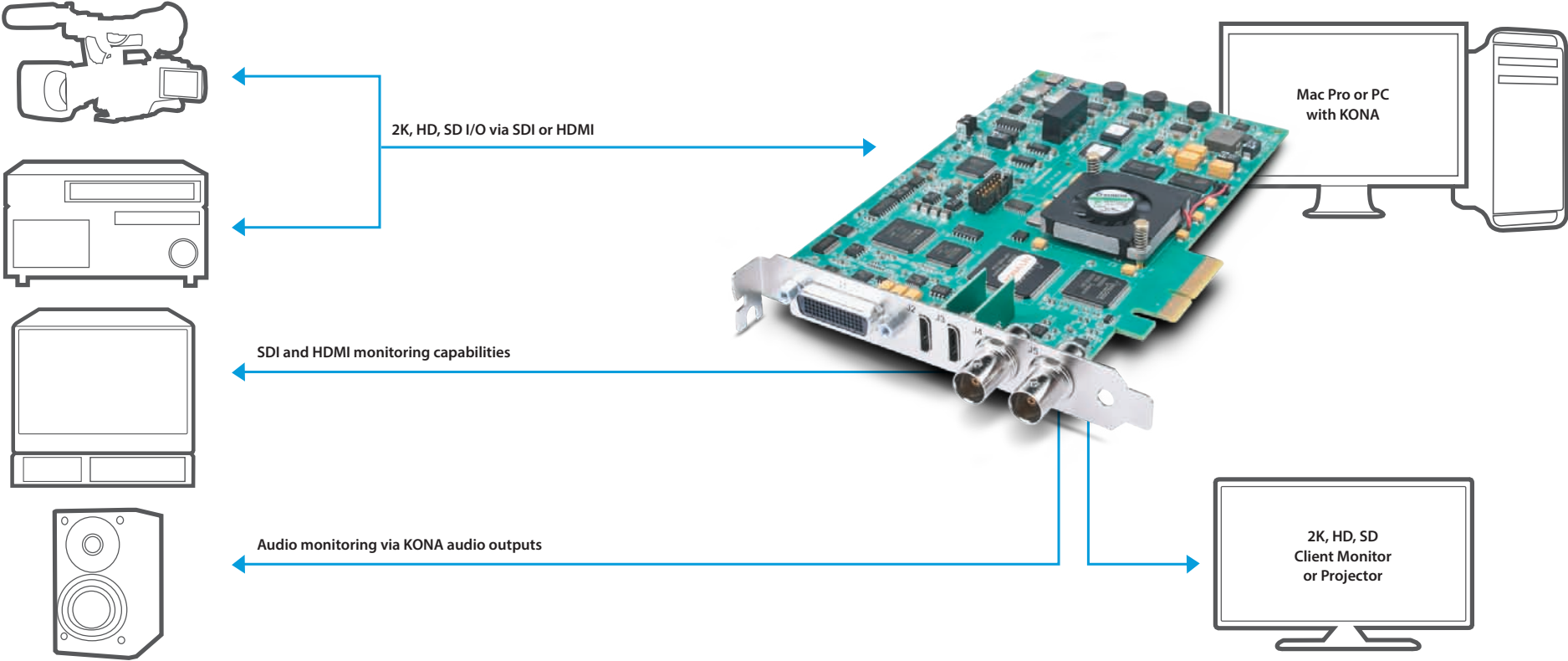

Connect your digital sources via SD/HD-SDI or HDMI to KONA for capture and editing via a wide variety of formats. Master to any Digital or Analog device through high-quality professional SDI, HDMI or Component outputs.

Connections

KLHI-BOX Breakout Box
(Optional)



[Click here](#) ▶ For full product specifications visit www.aja.com/kona-lhi/techspecs

Connections

Breakout cables
(Supplied)

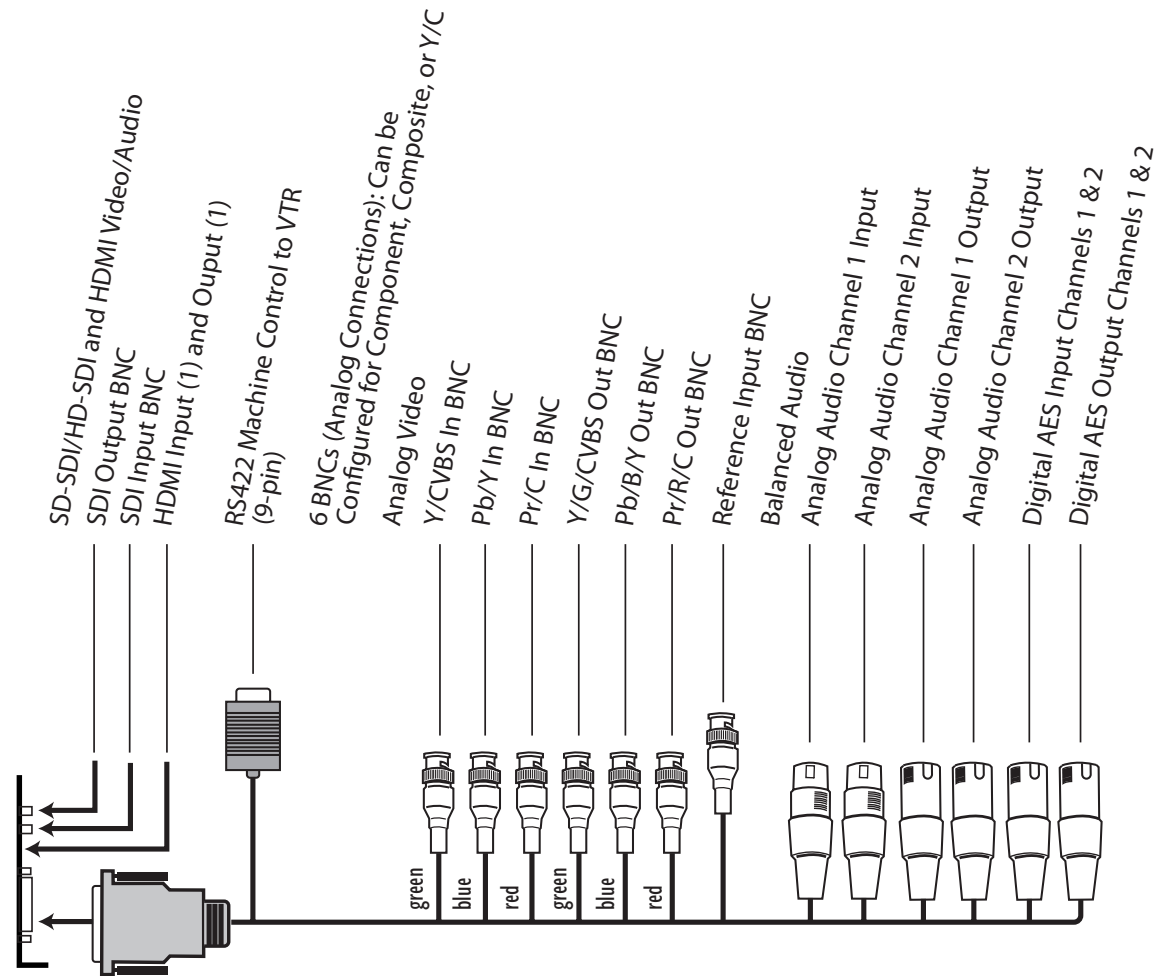

[Click here](#)



For full product specifications visit www.aja.com/kona-lhi/techspecs

Tech Specs

Video Formats

- 525i 23.98*, 29.97
- 625i 25
- 720p 23.98*, 50, 59.94, 60
- 1080i 25, 29.97, 30
- 1080PsF 23.98, 24
- 1080p 23.98, 24, 25, 29.97, 30, 50, 59.94, 60
- 2048 x 1080P 23.98, 24, 25, 29.97, 30
- 2048 x 1080PsF 23.98, 24

*These formats are dependent on specific software functionality and are not normal 'over-the-wire' formats.

Video Input Digital

- 3G/SD/HD SDI, SMPTE-259/292/296/424, 8- or 10-bits
- Single Link 4:2:2 (1 x BNC)
- HDMI v1.3 30 bits/pixel, RGB or YUV, 2.25 Gbps, SD, HD, 1080p-50/60

Video Output Analog

- Composite/S-Video (Y/C) (1 x BNC/2x BNC+adapter)
- NTSC, NTSCJ, PAL
- Component (3 x BNC)
- HD: YPbPr, RGB
- SD: YPbPr, RGB (component mode)
- SMPTE/EBU N10, Betacam 525 line, Betacam 525J, RGB
- 12-bit D/A, 8x oversampling
- +/- .2 dB to 5.0 MHz Y Frequency Response
- +/- .2 dB to 1 MHz C Frequency Response
- .5% 2T pulse response
- <1% Diff Phase
- <1% Diff Gain
- <1 ns Y/C delay inequity

Video Output Digital

- 3G/SD/HD SDI, SMPTE-259/292/296/424
- Single Link 4:2:2 or 4:4:4 (1 x BNC)
- HDMI v1.3 30 bits/pixel, RGB or YUV, 2.25 Gbps, SD, HD, 1080p-50/60

Video Output Digital

- Composite/S-Video (Y/C) (1 x BNC/2x BNC)
- NTSC, NTSCJ, PAL
- 12-bit D/A, 8x oversampling
- +/- .2 dB to 5.0 MHz Y Frequency Response
- +/- .2 dB to 1 MHz C Frequency Response
- .5% 2T pulse response
- <1% Diff Phase
- <1% Diff Gain
- Component (3 x BNC)
- HD: YPbPr, RGB
- SD: YPbPr, RGB (component mode)
- SMPTE/EBU N10, Betacam 525 line, Betacam 525J, RGB
- 12-bit D/A, 8x oversampling
- +/- .2 dB to 5.5 MHz Y Frequency Response
- +/- .2 dB to 2.5 MHz C Frequency Response
- .5% 2T pulse response
- <1 ns Y/C delay inequity

Audio Input Digital

- 8-channel, 24-bit SDI embedded audio, 48kHz sample rate, Synchronous
- 8-channel, 24-bit HDMI embedded audio, 48kHz sample rate, Synchronous
- 2-channel, 24-bit AES/EBU audio, 48kHz sample rate, Synchronous or Non-synchronous, Internal sample rate conversion (via 1 x XLR on breakout cable or optional KLHi-Box)

[Click here](#)



For full product specifications visit www.aja.com/kona-lhi/techspecs

(Continued on Next Page)

Tech Specs *(Continued)*

Video Input Analog

- Composite/S-Video (Y/C) (1 x BNC/2x BNC+adapter)
- NTSC, NTSCJ, PAL
- Component (3 x BNC)
- HD: YPbPr, RGB
- SD: YPbPr, RGB (component mode)
- SMPTE/EBU N10, Betacam 525 line, Betacam 525J, RGB
- 12-bit D/A, 8x oversampling
- +/- .2 dB to 5.0 MHz Y Frequency Response
- +/- .2 dB to 1 MHz C Frequency Response
- .5% 2T pulse response
- <1% Diff Phase
- <1% Diff Gain
- <1 ns Y/C delay inequity

Audio Input Analog

- 2-channel, 24-bit A/D analog audio, 48kHz sample rate, balanced (via 2 x XLR on breakout cable or optional KLHi-Box)
- +24 dBu Full Scale Digital
- +/- 0.2 dB 20Hz to 20kHz Frequency Response

Audio Output Digital

- 8-channel, 24-bit SDI embedded audio, 48kHz sample rate, Synchronous
- 8-channel, 24-bit HDMI embedded audio, 48kHz sample rate, Synchronous
- 2-channel, 24-bit AES/EBU audio, 48kHz sample rate, Synchronous or Non-synchronous, Internal sample rate conversion (via 1 x XLR on breakout cable or optional KLHi-Box)

Audio Output Analog

- 2-channel, 24-bit D/A analog audio, 48kHz sample rate, balanced (via 2 x XLR on breakout cable or optional KLHi-Box)
- +24 dBu Full Scale Digital (0 dBFS)
- +/- 0.2 dB 20Hz to 20kHz Frequency Response
- 2-channel unbalanced output (via 2 x RCA jacks on optional KLHi-Box)

Up-Conversion

- Hardware 10-bit
- Anamorphic: full-screen
- Pillar box 4:3: results in a 4:3 image in center of screen with black sidebars
- Zoom 14:9: results in a 4:3 image zoomed slightly to fill a 14:9 image with black side bars
- Zoom Letterbox: results in image zoomed to fill full screen
- Zoom Wide: results in a combination of zoom and horizontal stretch to fill a 16:9 screen; this setting can introduce a small aspect ratio change

Down-Conversion

- Hardware 10-bit
- Anamorphic: full-screen
- Letterbox: image is reduced with black top and bottom added to image area with the aspect ratio preserved
- Crop: image is cropped to fit new screen size

Cross-Conversion

- Hardware 10-bit
- 1080i to 720P
- 720P to 1080i
- 720P to 1080PsF

SD to SD Aspect Ration Conversion

- Letterbox: This transforms SD anamorphic material to a letterboxed image.
- H Crop: Will produce a horizontally stretched effect on the image; transforms anamorphic SD to full frame
- SD Pillarbox: Will produce an image in the center of the screen with black borders on the left and right sides and an anamorphized image in the center
- V Crop: Will transform SD letterbox material to an anamorphic image.

Reference Input

- Analog Color Black (1V) or Composite Sync (2 or 4V)
- Looping
- 75 ohm on optional KLHi-Box, terminated on supplied breakout cable

Machine Control

- RS-422, Sony 9-pin protocol (via breakout cable or optional KLHi-Box)
- 9-pin D-connector pinout is as follows:

1	GND
2	RX-
3	TX+
4	GND
5	No Connection
6	GND
7	RX+
8	TX-
9	GND
Shell	GND

[Click here](#)



For full product specifications visit www.aja.com/kona-lhi/techspecs

KONA^{LHe} Plus



Only \$995 US MSRP*

[Find a Reseller](#)

Powerful video and audio I/O with a full set of no-compromise features for video professionals.

Affordable, flexible KONA power

Add the power of AJA's KONA I/O to your system for high-quality capture and output that fits within any budget.

KONA LHe Plus offers video professionals at all levels an affordable desktop I/O solution that doesn't compromise on quality or essential functionality and features.

KONA LHe Plus supports both SD/HD analog and digital I/O for video and audio, providing maximum capability in a single card, simplifying integrating analog and digital signals into a single workflow and provides multiple output options to ensure you can deliver whatever formats are required.

For SDI video, the KONA LHe Plus features one input and two outputs and can be configured independently for HD or SD. It offers Genlock input, and three BNCs which may be configured for analog video input and output (HD or SD). Also included is a 9-pin connector for RS-422 machine control. Because the KONA LHe Plus supports 12-bit analog component HD input and output, devices with analog HD output, such as decks and even game consoles, can be connected for a variety of workflows.

The broadcast-quality down-converter in the LHe Plus allows it to connect to analog SD devices for output. This can be used to check framing and color for SD versions while still working in full resolution HD within your application, ensuring proper quality for multi-format deliveries. Since conversion is hardware-based, it's available during ingest or playback.

Like all KONA cards, LHe Plus connectivity can be extended via the KL-Box-LH breakout box, enabling simple integration into rack environments, with quick access to all video and audio connections and additional AES/EBU audio connectivity without having to access the back of the computer tower.



Utilize the KL-BOX-LH Breakout Box to easily integrate KONA LHe Plus into rackmount environments.

Connections

KL-BOX-LH Breakout Box
(Optional)



[Click here](#) ▶ For full product specifications visit www.aja.com/kona-lhe-plus/techspecs

Connections

Breakout cables
(Supplied)

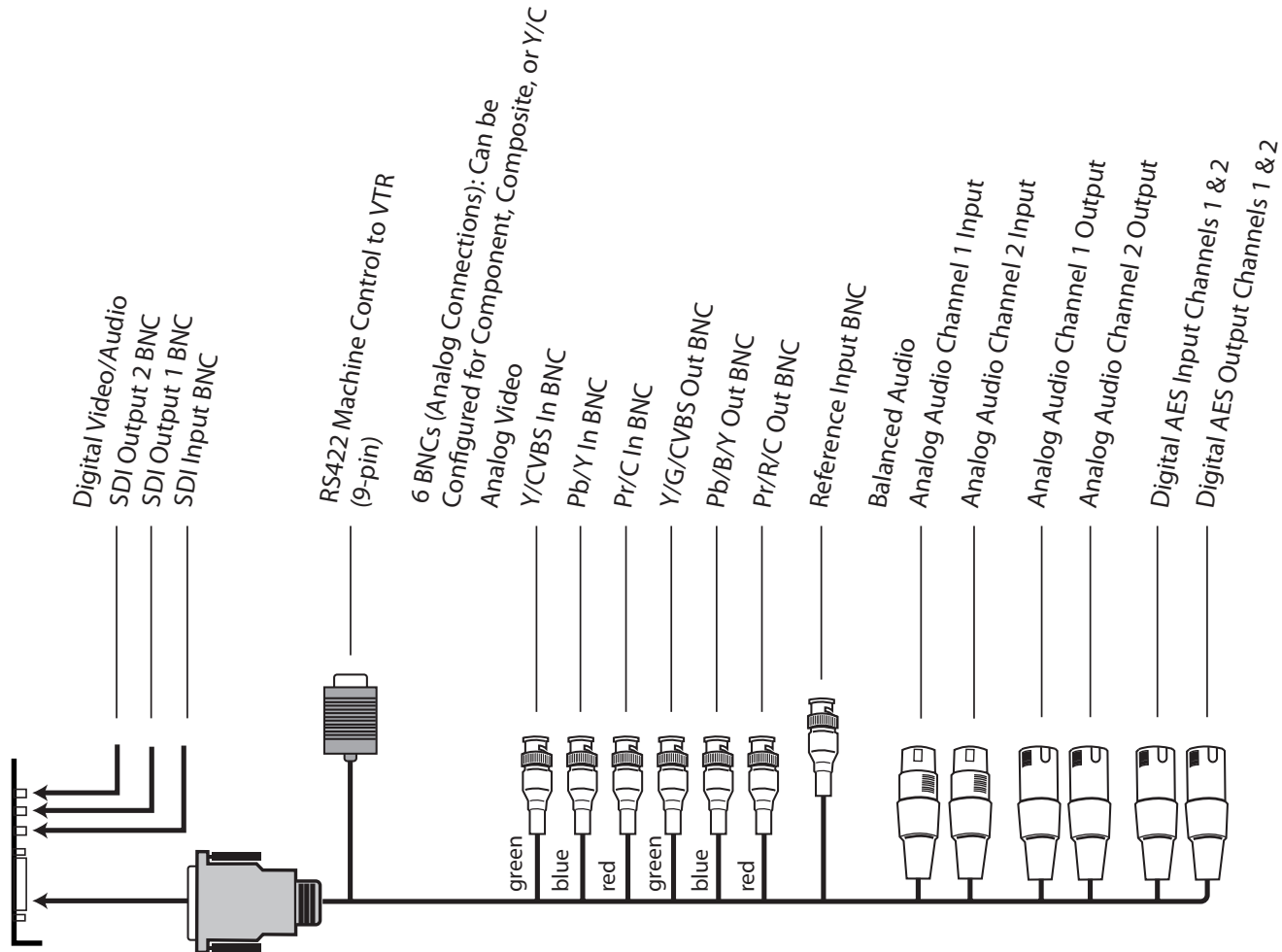

[Click here](#)



For full product specifications visit www.aja.com/kona-lhe-plus/techspecs

KONA^{LHe Plus}

Workflow

KONA-powered workflows

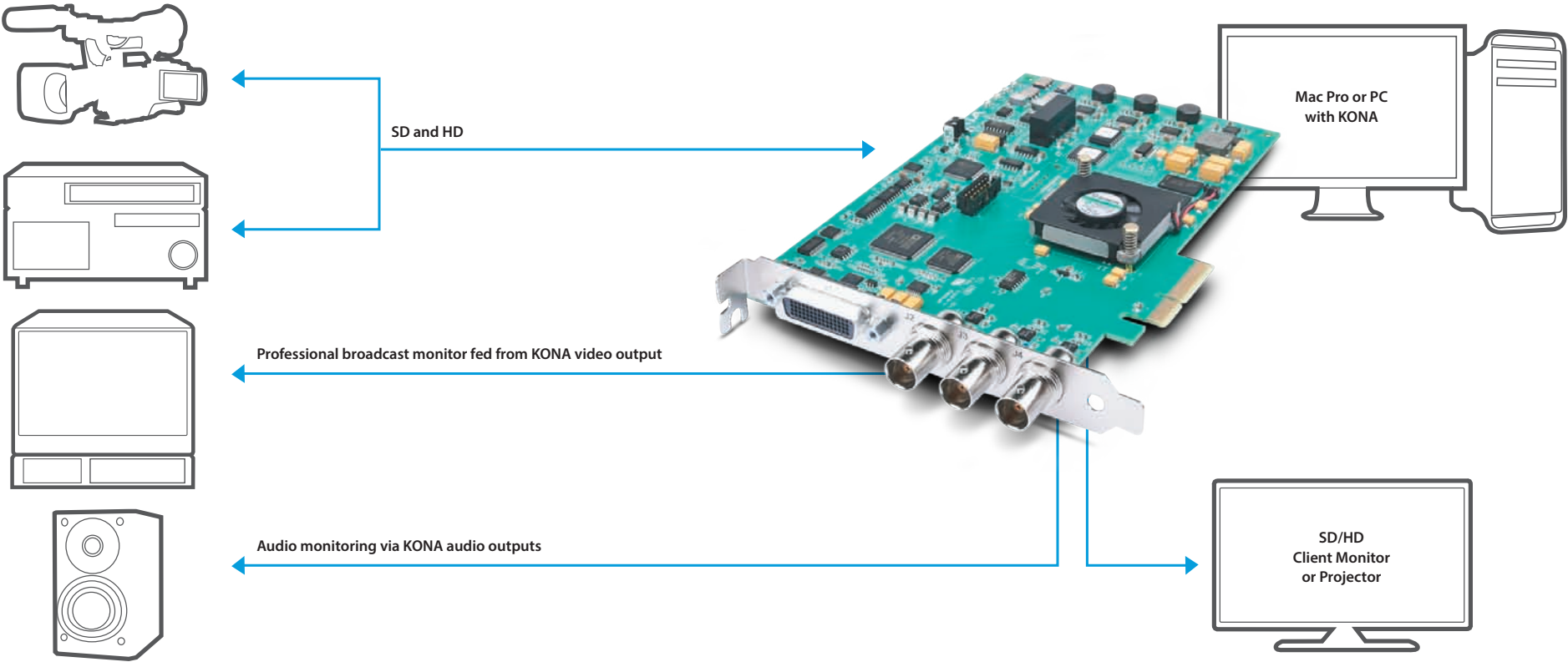

Connect your digital sources via SD/HD-SDI to KONA for capture and editing via a wide variety of formats.
Master through high-quality professional SDI and Component outputs.

Tech Specs

Video Formats

- 525i 29.97
- 625i 25
- 720p 50, 59.94, 60
- 1080i 25, 29.97, 30
- 1080PsF 23.98, 24, 25, 29.97, 30
- 1080p 23.98, 24, 25, 29.97, 30

Video Input Digital

- SD/HD SDI, SMPTE-259/292/296, 8- or 10-bits
- Single Link 4:2:2 (1 x BNC)

Video Input Analog

- Composite/S-Video (Y/C) (1 x BNC/2x BNC+adapter)
- NTSC, NTSCJ, PAL
- Component (3 x BNC)
- HD: YPbPr, RGB
- SD: YPbPr, RGB (component mode)
- SMPTE/EBU N10, Betacam 525 line, Betacam 525J, RGB
- 12-bit D/A, 2x oversampling
- +/- .2 dB to 5.0 MHz Y Frequency Response
- +/- .2 dB to 1 MHz C Frequency Response
- .5% 2T pulse response
- <1% Diff Phase
- <1% Diff Gain
- <1 ns Y/C delay inequity

Video Output Digital

- SD SDI, SMPTE-259M, 10-bit
- HD SDI, SMPTE-292/296, 10-bit

Video Output Analog

- Composite/S-Video (Y/C) (1 x BNC/2x BNC+adapter)
- NTSC, NTSCJ, PAL
- Component (3 x BNC)
- HD: YPbPr, RGB
- SD: YPbPr, RGB (component mode)
- SMPTE/EBU N10, Betacam 525 line, Betacam 525J, RGB
- 12-bit D/A, 8x oversampling
- +/- .2 dB to 5.0 MHz Y Frequency Response
- +/- .2 dB to 1 MHz C Frequency Response
- .5% 2T pulse response
- <1% Diff Phase
- <1% Diff Gain
- <1 ns Y/C delay inequity

Audio Input Digital

- 8-channel, 24-bit SDI embedded audio, 48kHz sample rate, Synchronous
- 2-channel, 24-bit AES/EBU audio, 48kHz or 96 KHz sample rate, Synchronous or Non-synchronous, Internal sample rate conversion (via 1 x XLR on breakout cable or optional KL-BOX-LH)

Audio Input Analog

- 2-channel, 24-bit A/D analog audio, 48kHz sample rate, balanced (via 2 x XLR on breakout cable or optional KL-BOX-LH)
- +24 dBu Full Scale Digital
- +/- 0.2 dB 20 to 20kHz Frequency Response

Audio Output Digital

- 8-channel, 24-bit SDI embedded audio, 48kHz sample rate, Synchronous
- 2-channel, 24-bit AES/EBU audio, 48kHz or 96 KHz sample rate, Synchronous or Non-synchronous, Internal sample rate conversion (via 1 x XLR on breakout cable or optional KL-BOX-LH)

Audio Output Analog

- 2-channel, 24-bit D/A analog audio, 48kHz sample rate, balanced (via 2 x XLR on breakout cable or optional KL-Box)
- +24 dBu Full Scale Digital (0 dBFS)
- +/- 0.2 dB 20Hz to 20kHz Frequency Response
- 2-channel unbalanced output (via 2 x RCA jacks on optional KL-BOX-LH)

Down-Conversion

- Hardware 10-bit
- Anamorphic: full-screen
- Letterbox: image is reduced with black top and bottom added to image area with the aspect ratio preserved
- Crop: image is cropped to fit new screen size

Reference Input

- Analog Color Black (1V) or Composite Sync (2 or 4V)
- Looping
- 75 ohm on optional KL-BOX-LH, terminated on supplied breakout cable

Machine Control

- RS-422, Sony 9-pin protocol (via breakout cable or optional KL-BOX-LH)
- 9-pin D-connector pinout is as follows:

1	GND
2	RX-
3	TX+
4	GND
5	No Connection
6	GND
7	RX+
8	TX-
9	GND
Shell	GND

[Click here](#)



For full product specifications visit www.aja.com/kona-lhe-plus/techspecs

Incredible 3-year warranty

AJA Video warrants that KONA products will be free from defects in materials and workmanship for a period of three years from the date of purchase.

About AJA Video Systems, Inc.

Since 1993, AJA Video has been a leading manufacturer of video interface and conversion solutions, bringing high-quality, cost-effective digital video products to the professional broadcast and post-production markets.

AJA offers the Io and KONA desktop video products, Ki Pro family of recorders, miniature standalone converters, and a complete line of rack mount interface and conversion cards and frames.

With a headquarters and design center located in Grass Valley, California, AJA Video offers its products through an extensive sales channel of dealers and systems integrators around the world. For further information, please see our website at www.aja.com

Because it matters.™

AJA Video Systems Inc.
Grass Valley, California
www.aja.com • sales@aja.com • support@aja.com

