

DLG PLUS

Digital Logo Generator



USER MANUAL Rev. 2.0

SEDE DI BOLOGNA:

VIA CADUTI DI SABBIUINO 6/F • 40011 ANZOLA EMILIA • BOLOGNA • ITALY
PHONE: +39 051 736555 • +39 051 736154 • FAX: +39 051 736170
e-mail: info@axeltechnology.com • <http://www.axeltechnology.com>

SEDE DI BERGAMO:
VIA ITALIA, 1
24030 MEDOLAGO • BERGAMO • ITALY

SEDE DI LUCCA - Broadcast Audio Devices s.r.l.
VIALE MARCONI, 86
55045 PIETRASANTA • LUCCA • ITALY

SEDE DI ROMA:
VIA SALARIA, 223 C
00015 MONTEROTONDO • ROMA • ITALY

TABLE OF CONTENTS

- 1 INTRODUCTION 3**
 - 1.1 WHAT IS THE DIGITAL LOGO GENERATOR? 3
 - 1.2 WHY DIGITAL LOGO GENERATOR? 3
- 2 HARDWARE SETTINGS 4**
 - 2.1 FRONT VIEW 4
 - 2.2 REAR VIEW 4
 - 2.3 VIDEO CONNECTIONS 4
 - 2.4 VIDEO OUTPUT - AVAILABLE CONFIGURATION 5
- 3 CONFIGURATION 6**
 - 3.1 RUN THE PROGRAM 6
 - 3.2 PLAYOUT - MULTICHANNEL 7
 - 3.3 PLAYOUT - SINGLE CHANNEL 8
 - 3.4 COMPOSER 9
 - 3.5 SETUP 12
 - 3.6 SCHEDULER 15
 - 3.7 LOG 16
- 4 TUTORIAL 17**
 - 4.1 HOW TO CREATE A NEWS TEMPLATE. 17
- 5 RESTORE 33**
 - 5.1 PROCEDURE 33
 - 5.2 DLG PLUS SETUP 33
 - 5.3 HARDWARE KEY 35

1 INTRODUCTION

Congratulations on your purchase of Axel Digital Logo Generator, the broadcasting graphic device server.

1.1 WHAT IS THE DIGITAL LOGO GENERATOR?

Axel DLG Plus is a software based solution for multichannel logo generation. It works with BlackMagicDeckLink video boards and allows you to broadcast simultaneously from 1 to 4 channels and it supports any video resolution (from SD to 4K).

For each channel, DLG Plus provides up to 15 different templates and a blank one customizable with a user friendly Composer. The operator could add from static logos to dynamic swf files or animated png and tga sequences.

1.2 WHY DIGITAL LOGO GENERATOR?

Axel DLG Plus is set as a standalone graphic logo generator. The system could receive commands from external devices for hot keys functions (MOXA boards, RS232, custom Keyboards) to load and play multiple pages.

The simple Composer platform gives you a wide range of possibilities to set position, transparency, static effects (blur, glow, shadow, ecc) and in & out transition effects for each object.

The interactive Axel DLG engine allows to switch from different templates always in a blend mode (without cut) recognizing same elements and adding just new ones. This smart solution permits infinite* layers of graphic. Web interface for simple configuration and management.

* It depends on the PC hardware performance.

2 HARDWARE SETTINGS

2.1 FRONT VIEW



2.2 REAR VIEW



Power connection

USB HDMI

DVI

USB LAN Audio Out

Breakout Cable

2.3 VIDEO CONNECTIONS

HD-SDI In Ch B SD/HD-SDI In Ch SD/HD-SDI Out Ch SD/HD-SDI Out Ch

- 2. Deck Control
- 3. R-Y In
- 4. Y In
- 5. B-Y In
- 6. Ref In
- 7. R-Y Out
- 8. Y Out
- 9. B-Y Out
- 10. AES/EBU Out
- 11. AES/EBU In
- 12. Audio Out Left
- 13. Audio Out Right
- 14. Audio In Left
- 15. Audio In Right

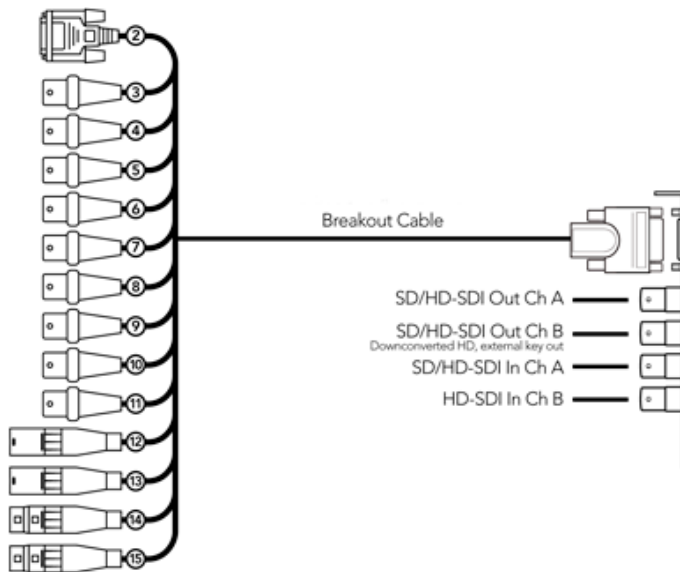

2.4 VIDEO OUTPUT - AVAILABLE CONFIGURATION

iVGA

- 1 - Channel 1
- 2 - Channel 2

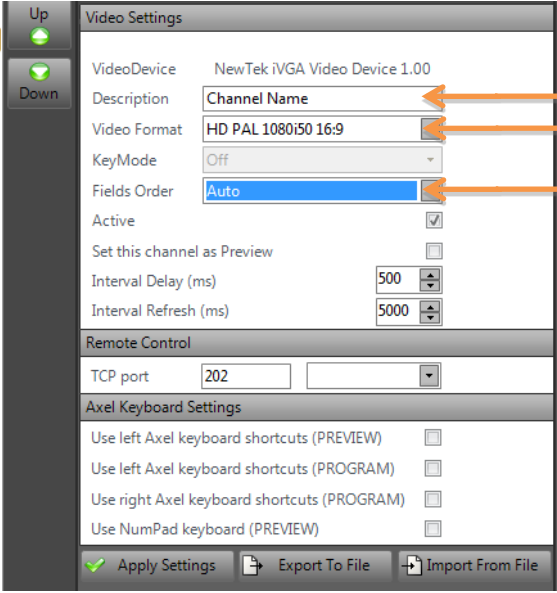

Enter here the name of your channel
Set a resolution for the video output
Customize fields' order

Extreme 4K video card:

- 1 - Channel 1
- 2 - Channel 2

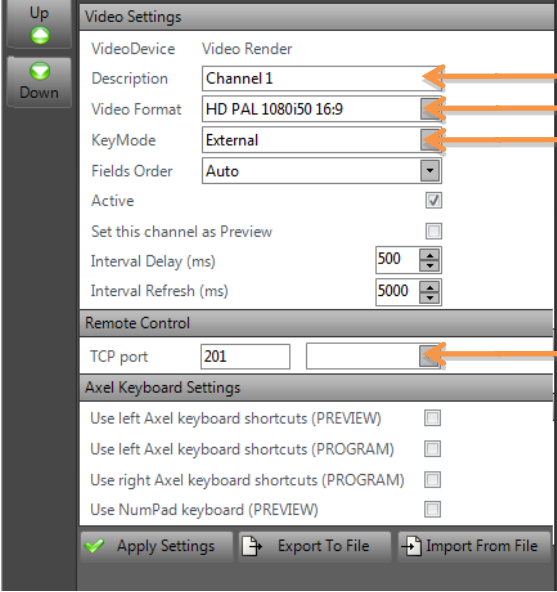

Enter here the name of your channel
Set a resolution for the video output
Define Key Mode: external, internal, off
Set TCP Port for remote control.

DLGPlus could be remotely controlled by automation software such as Axel Technology's XTV, DigiTV and third-party systems.

3 CONFIGURATION

DLG configuration requires only the manual insertion of a standard format for the Blackmagic video card installed on your PC. The program automatically will set the format for all Blackmagic's output channels.

After that, you can set a different format to suit your needs for each channel.

For each BlackMagic channel installed, the program will create automatically 5 output pages + 1 blank page with some logos added into each page.

The user can add, edit or delete individual logos for each page at any time.

3.1 RUN THE PROGRAM

Please, start the "DigitalLogoGenerator.exe" file:

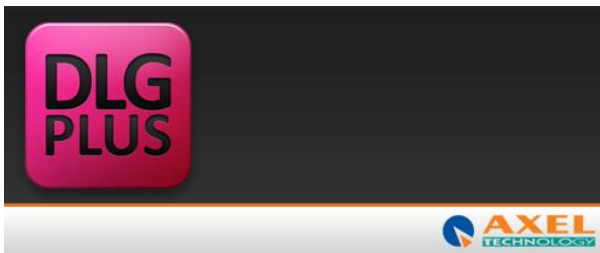

WARNING:

If you don't have any BlackMagic video board installed into your PC an error message will appear and DLG will close.

Now, you must choose a BlackMagic supported format from the list:

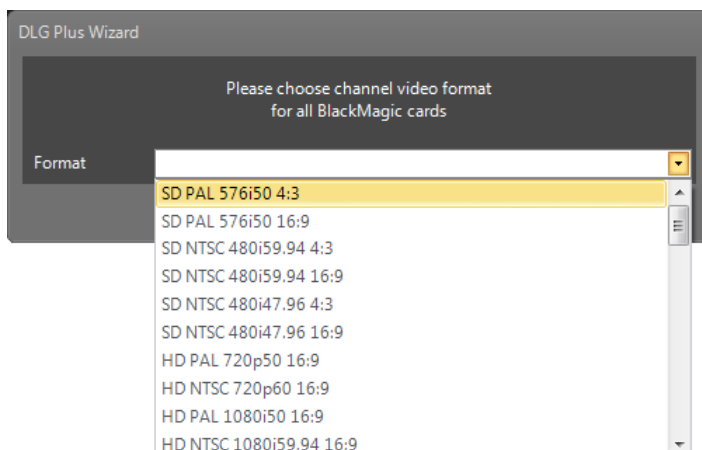

After that, click on "OK" button and wait until the program finishes to set all the necessary configurations. When DLG configuration has finished, the main program screen will appear.

3.2 *PLAYOUT - MULTICHANNEL*

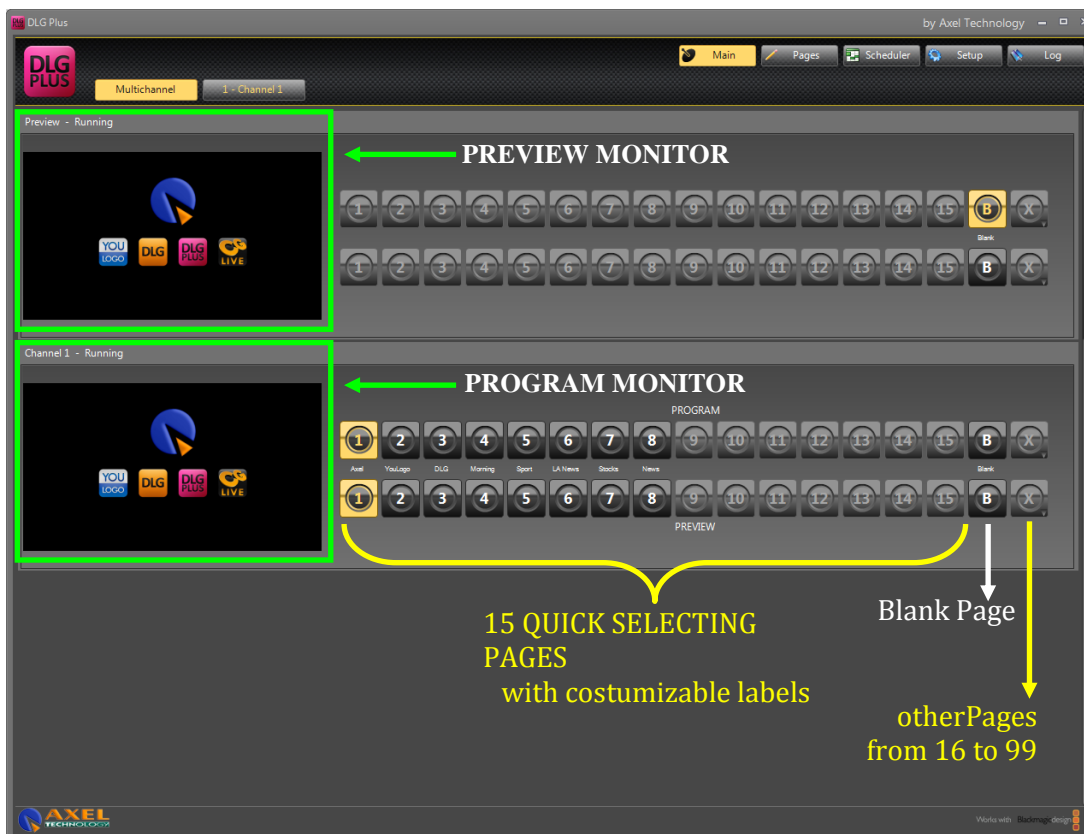

The DLG's Playout Multichannel is the starting page layout. It's the summary of all the output channels set during the configuration. You will see all the supported BlackMagic video board's available channels.

Channel

- For each channel you can choose among 15 available pages for the Program channel and 15 available pages for the Preview channel; a blank page and the last button allows you to recall all the saved pages from 16 to 99.
- The Preview channel choice is exclusive: only one Preview channel is allowed.
- At any time you can see the status of each BlackMagic channel.

It is possible to change channels' layout page simply by clicking on the available page you want to send to output.

3.3 *PLAYOUT - SINGLE CHANNEL*



In addition to multichannel, the Playout menu offers a view for each channel (excluding Preview channel). Each channel shows the visualization of what is going on the air in the Preview channel and also in the selected channel.

This view, compared to the Multichannel one, allows to read the page's description of the selected channel. In this way it is easier to remember what page is on the air.

It is possible to change channels' layout page simply by clicking on the available page you want to send to output.

3.4 COMPOSER



The Composer page is used to create or edit output’s pages for each channel. It is possible also to see the changes made to the temporary page with the buttons “Take Preview” (on the Preview channel) and “Take Program” (on the current channel).



- 1 Choose and select the available channels.
- 2 Select the page you want to modify.
- 3 Insert a “Title” for the selected page.
- 4 You can add a key combination to recall the page from the keyboard when you are on the “main” section.
- 5 You can add a GPI device to select the page. DLG Plus accepts commands from MOXA boards and RS232 commands:

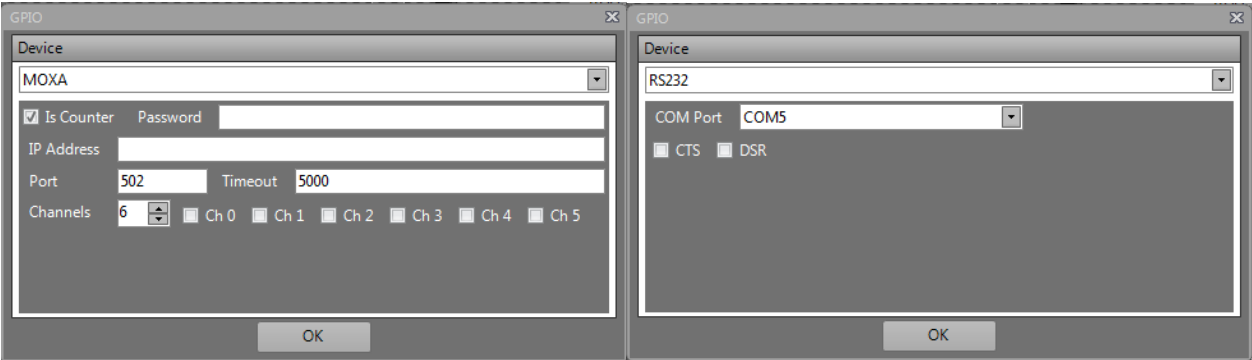

Any changes to the page can be undone using the "UNDO" button, or saved by the "SAVE" one. In addition, you can see real-time changes to the page without saving using the buttons "Take Preview" and "Take Program".



- 1 Remove all the objects from the page. A pop-up will appear to confirm the operation.
- 2 You can import a composition from other pages using a quick selection pop-up

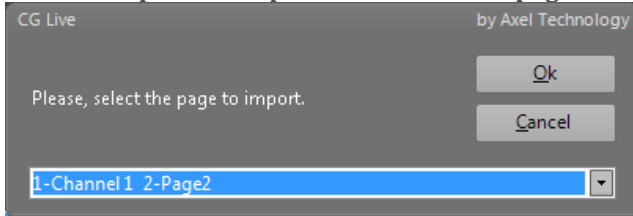

- 1 Import Axel Cg File (*.acg), for example pages done and exported previously.
- 2 This allows you to export the project for a backup copy or to use it into another DLG's machine.
- 3 Insert *.mp3 file to your composition.

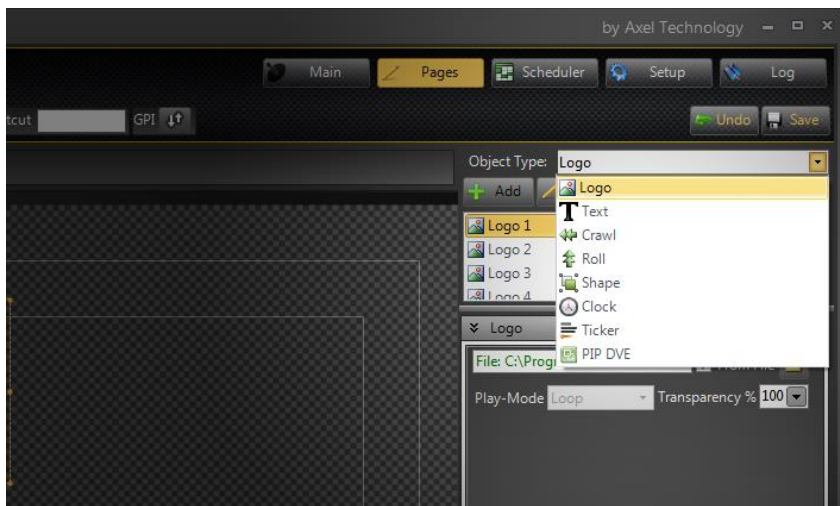

Objects you can import into the project.

The supported file types are: *.tga, *.swf, *.bmp, *.jpg, *.gif, *.png

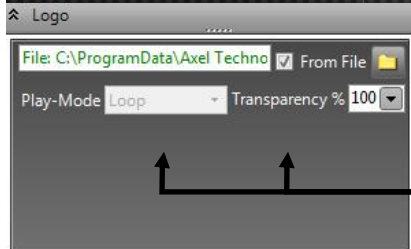

Browse to find an image or an animation to insert into the composition.

The supported file types are: *.tga, *.swf, *.bmp, *.jpg, *.gif, *.png

Set properties for the animation and opacity on screen.

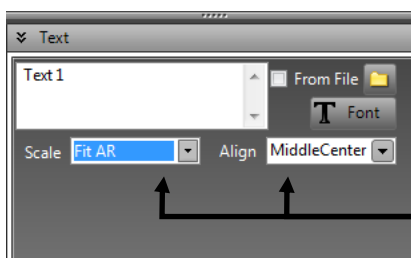

Type the text into the box or browse to get data from file.

The supported file types are: *.txt *.xlsx, RSS from web and Html links

Set properties for font style, size and alignment.

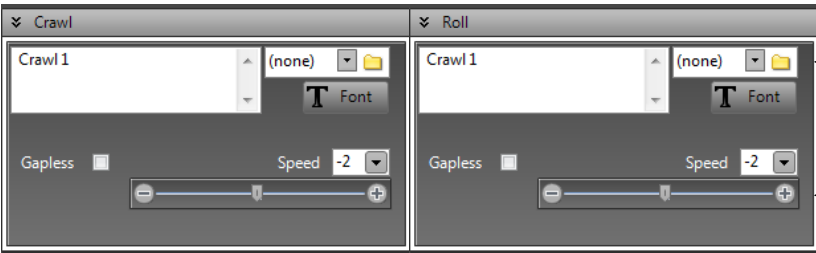

Type the text into the box or browse to get data from file.
The supported file types are: *.txt *.xlsx, RSS from web and Html links

Set properties of speed and with the Gapless function "selected" the way to play continuously the text on screen.

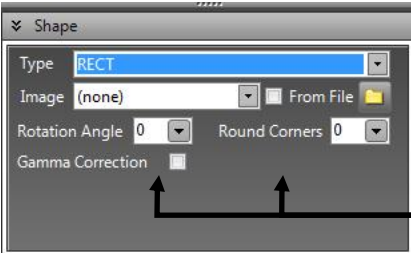

Choose from a selection of shapes and set an image to fill it.

Options to customize any shape and check gamma level.

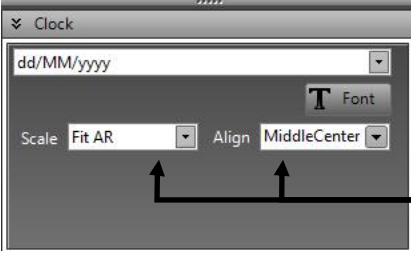

Select from a wide range of options the way to show Date and Time on your screen.

Set properties for font style, size and alignment.

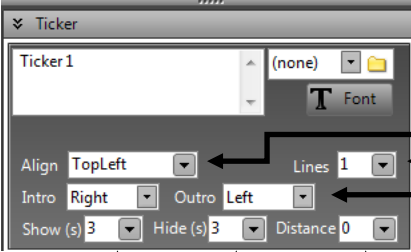

Type the text into the box or browse to get data from file.
The supported file types are: *.txt *.xlsx, RSS from web and Html links

Set alignment and number of lines to show each time.

Input and output transition

Set the timing in seconds of the "Stay on and off" to the screen of each ticker and the spacing between each line of text.

After inserting an object into the page you can surf in the menus on the right side of the screen to customize each parameter.

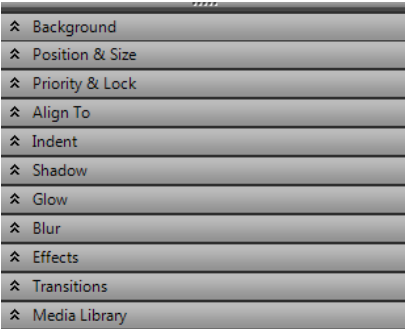

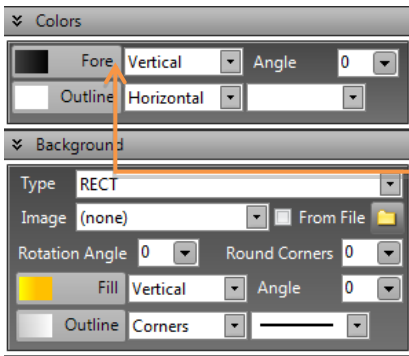

Set the foreground and background colors defining gradients, outlines, transparency for each element.

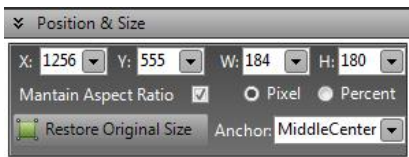
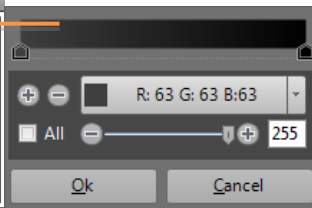

Set position and size (in pixel or percent) of the selected object. You can maintain the aspect ratio by checking the related box. "Restore.." will reset all the parameters to the default. Anchor allows you to resize the object from specific corners or from the center.



Move your object in front or behind other elements inside the composition. The "Locked" function allows you to freeze any property of the object.



Align the object with few clicks into the screen in specific positions such as center or on the safe area guides.

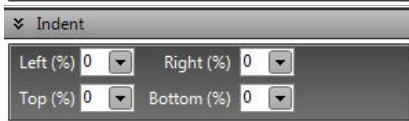

Set specific boundary inside an object. Check our sample to understand how powerful is this feature to create stunning and broadcast graphics!



Set options to customize shadows and give a good look to your project.



Real-time customizable FXs to express creativity in your composition.

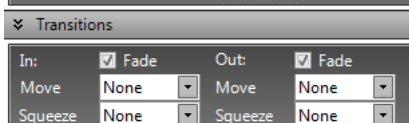
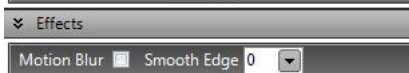

Catch your audience setting input and output transition for any object.



Store and manage your logos and animations for a quick recall.

3.5 SETUP

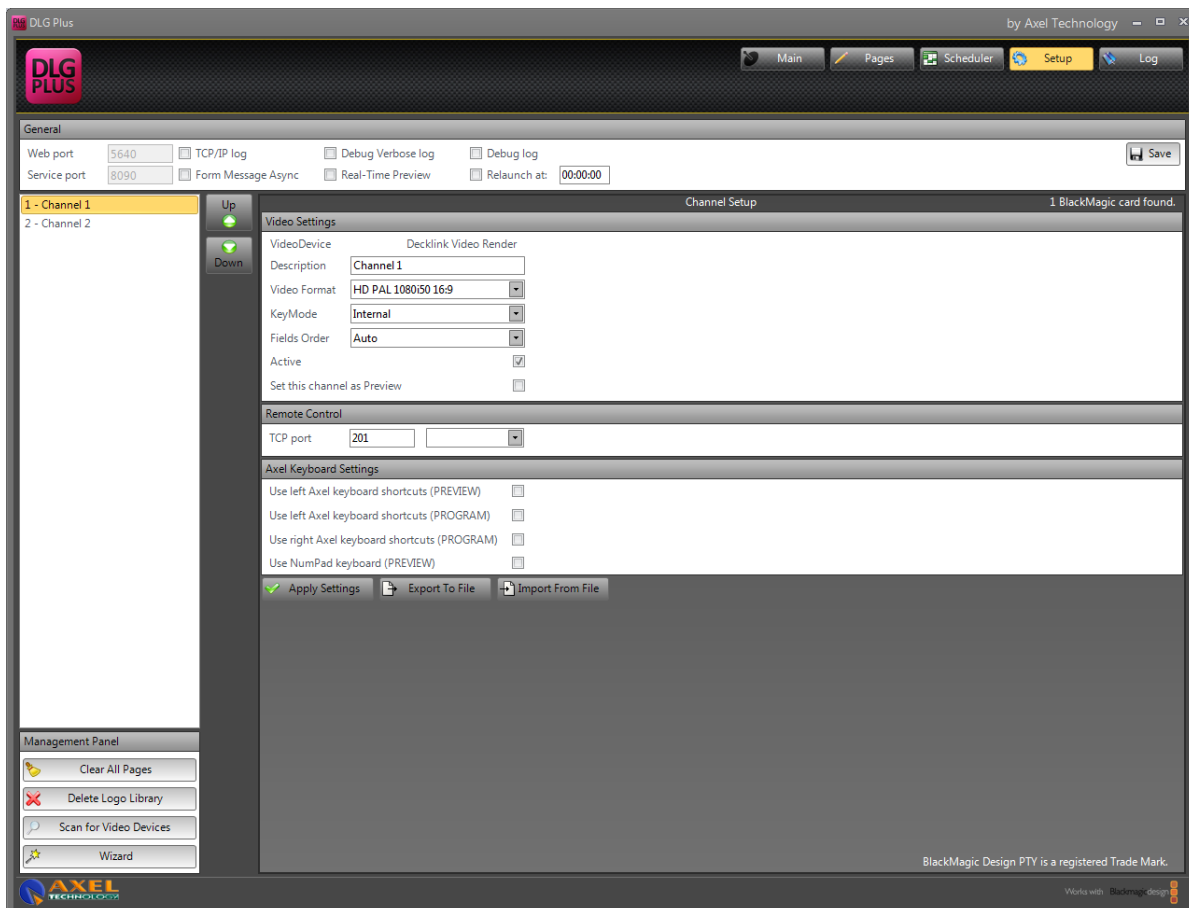

In the left list of the Setup page, you can choose the channels order by clicking on “Up” and “Down” buttons. In the rest of the Setup page you can change the selected channel properties:

- **Description:** the channel’s user description. User can distinguish from the others by setting this property page.
- **Format:** the channel’s resolution and aspect ratio. User can choose from all the supported BlackMagic format video resolution.
- **KeyMode:** the channel’s output mode. User can choose between off, internal or external mode.
- **Fields Order:** the channel’s fields order. User can choose between Auto, First Field, Second Field or Progressive order.
- **Active:** sets if the channel is active. User can uncheck this property if the channel is not enabled.
- **Set channel as Preview:** sets the channel to the preview channel. The User can choose to set the selected channel to be the preview channel.
ATTENTION: User can also choose to set all the available channels with no preview. Automatically a virtual VGA channel will be created as a preview channel.
- **Remote Control:** the remote connector’s channel port. User can upgrade the DLG to an ALG (Advanced Logo Generator) and set the remote port to wait for remote command from other programs such as Axel DigiTV.
- **Use left Axel Keyboard shortcuts:** it specifies whether the user can use, for the selected channel, the left keyboard of the Axel Keyboard commands shortcuts*.
- **Use right Axel Keyboard shortcuts:** it specifies whether the user can use, for the selected channel, the right keyboard of the Axel Keyboard commands shortcuts*.

- Export to file: it exports all the pages composed for the specific channel into a collection saved into a unique file - *.acgs.
- Import from file: it imports all the pages or a specific one contained into the *.acgs file.

When you want to save the channel's changes, click on "Set Channel". You can also "Re-Scan All" the available BlackMagic channels installed on the PC or "Reset All" the channels settings and restart the Wizard procedure (see 3.1).

* Axel Keyboard similar type:



•Management Panel:

- "Clear all the pages" deletes all the pages composed for that channel. WARNING: You will lose all your project!
- "Delete logo library" deletes all the logos stored into the media library
- "Scan for Video Devices" will scan your system in order to find new video devices that could be used by DLG Plus.
- "Wizard" is a step by step configuration of the system up to your requests.

3.6 SCHEDULER

The Scheduler section allows the user to set a specific playout timing for each graphic page.

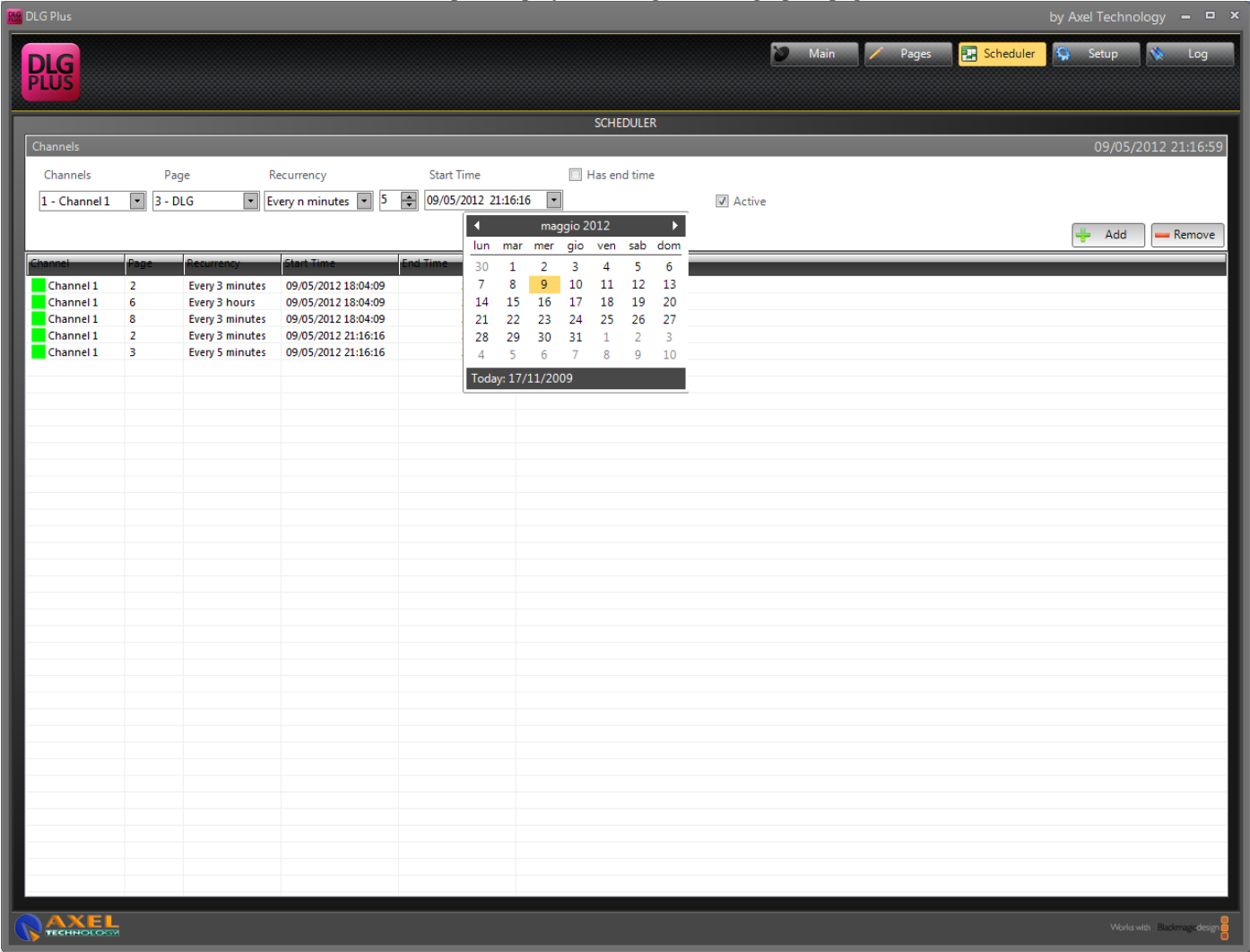

3.7 LOG

The Log page is a section that allows to overview all the saved DLG's user actions.

DLG Plus by Axel Technology

Main Pages Scheduler Setup Log

REPORT

Calendar 5/9/2012 Log 31 (31)

DateTime	Application	LogType	Message
5/9/2012 1:58 ...		INFO	Current page Page7 has been saved into the settings.
5/9/2012 1:30 ...		INFO	Logo 5 removed successfully.
5/9/2012 1:29 ...		INFO	Current page Page6 has been saved into the settings.
5/9/2012 1:29 ...		INFO	Logo 1 removed successfully.
5/9/2012 1:29 ...	Channel 2	INFO	Channel 2 channel panel has been initialized.
5/9/2012 1:29 ...	Channel 2	INFO	Initializing connection
5/9/2012 1:29 ...	Channel 2	INFO	StopServer
5/9/2012 1:29 ...	Channel 2	INFO	Remote connector started
5/9/2012 1:29 ...	Channel 3	INFO	Initializing connection
5/9/2012 1:29 ...	Channel 3	INFO	StopServer
5/9/2012 1:29 ...	Channel 3	INFO	Remote connector started
5/9/2012 1:29 ...	Channel 1	INFO	Channel 1 channel panel has been initialized.
5/9/2012 1:28 ...		INFO	Settings file has been deleted.
5/9/2012 1:28 ...		INFO	Wizard settings configuration finished.
5/9/2012 1:28 ...	Channel 2	INFO	Channel 2 channel panel has been de-initialized.
5/9/2012 1:28 ...	Channel 1	INFO	Channel 1 channel panel has been de-initialized.
5/9/2012 1:27 ...	Channel 2	INFO	Remote connector started
5/9/2012 1:27 ...	Channel 3	INFO	Initializing connection
5/9/2012 1:27 ...	Channel 3	INFO	StopServer
5/9/2012 1:27 ...	Channel 3	INFO	Remote connector started
5/9/2012 1:27 ...	Channel 2	INFO	StopServer
5/9/2012 1:27 ...	Channel 2	INFO	Channel 2 channel panel has been initialized.
5/9/2012 1:27 ...	Channel 2	INFO	Initializing connection
5/9/2012 1:27 ...	Channel 1	INFO	Channel 1 channel panel has been initialized.
5/9/2012 1:27 ...		INFO	Buildtime: 5/8/2012 12:53:56 PM

Show Logs

Current page Page7 has been saved into the settings.

Events & Logs Log queue count: 1

Extra Info

ALG (50) - Expiration: 1/15/2013 - Order #: 0 - Code: 00002806 - Customer: Macca Refresh

AXEL TECHNOLOGY Works with Backlog design

4 TUTORIAL

4.1 HOW TO CREATE A NEWS TEMPLATE.



Open a new page

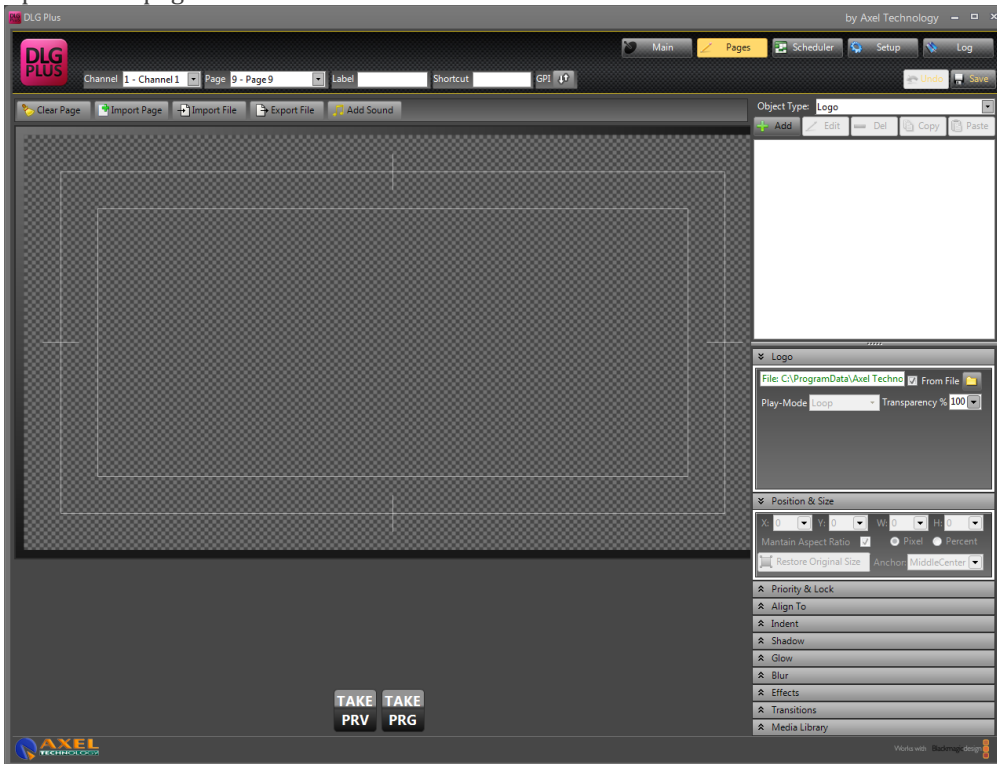

Type a Title into the Label Section

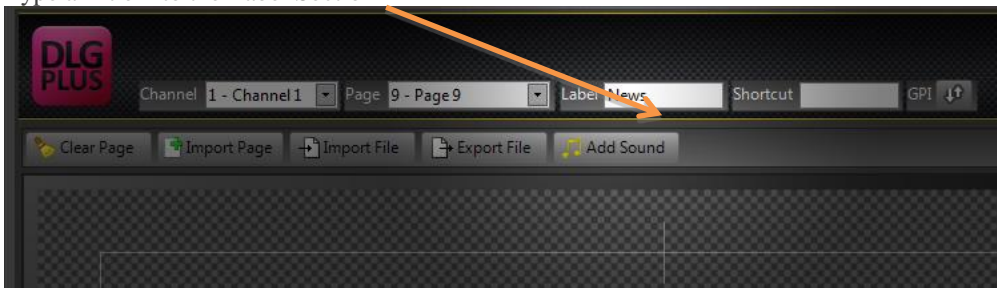

Into the object type menu, select "Shape" then press "Add"

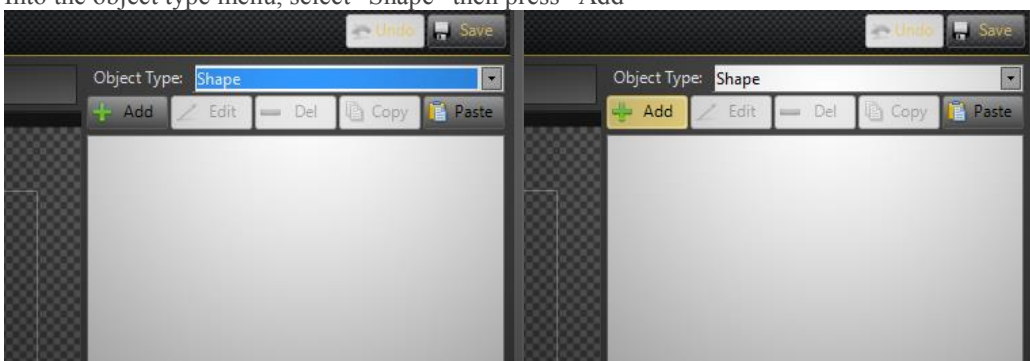

A white rectangle will appear into the composition. Select it!

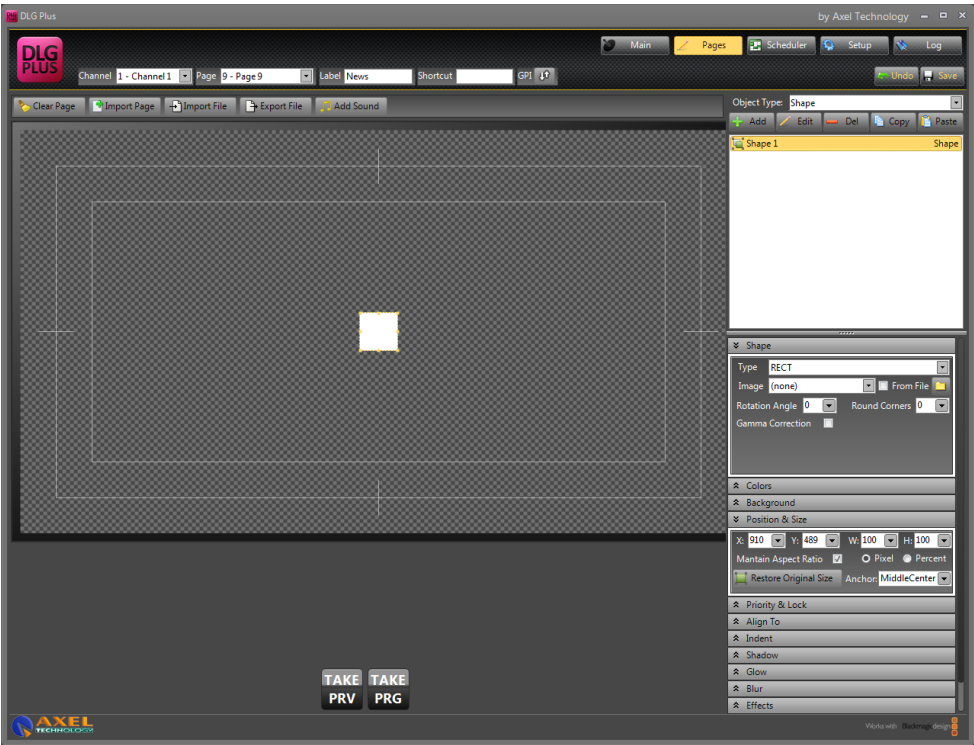

Open the “Colors” menu

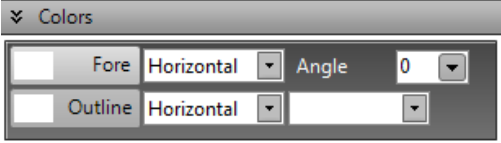

Select the “Foreground” color

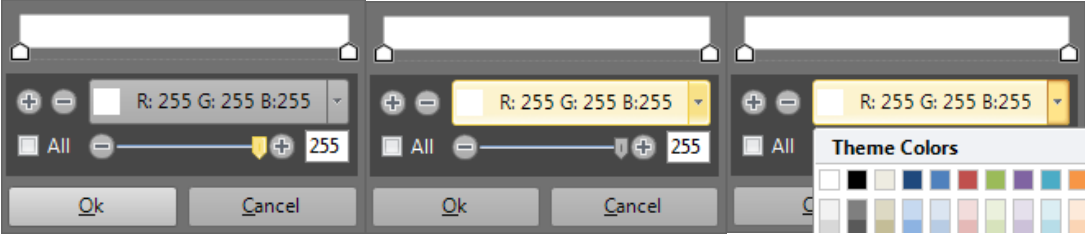
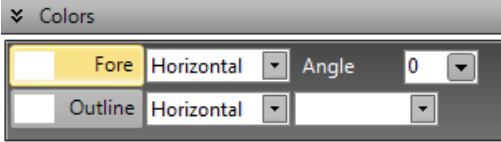

Then select “More Color” and define our dark red!

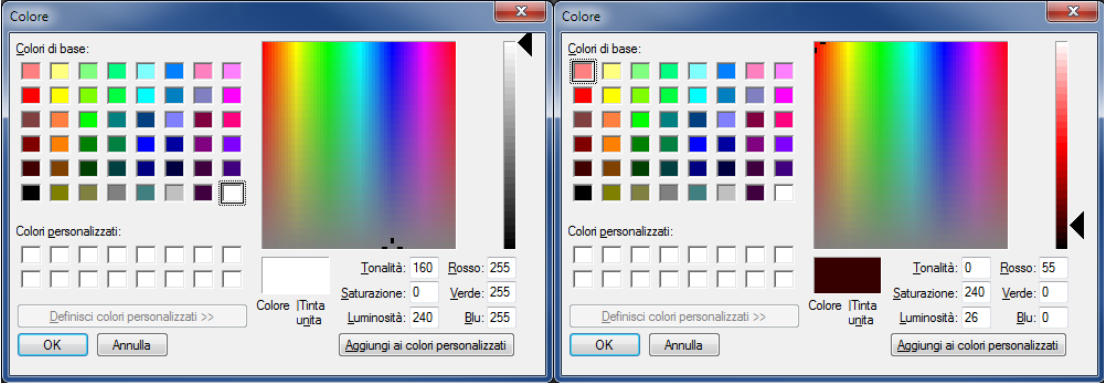

Once you confirm the choice, set the position and the dimension inside the “Position and Size” menu

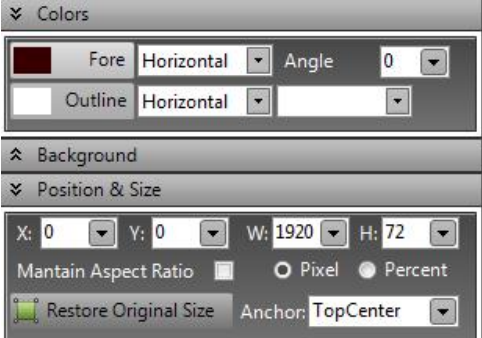

This is the result about our first elements added into our new composition!

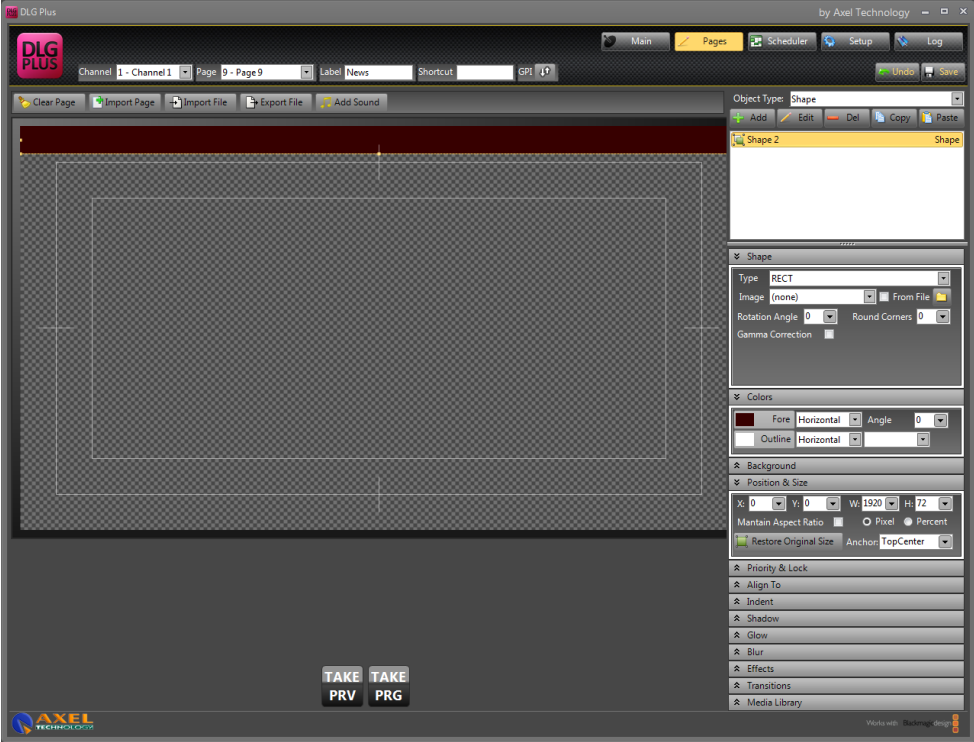

Copy and Paste the object

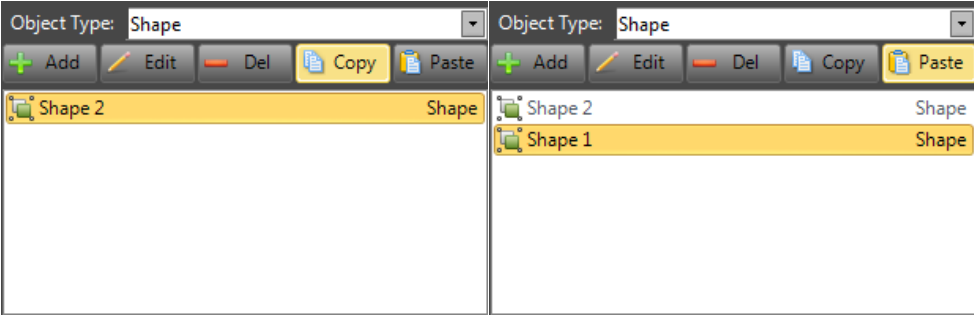

Pressing the “Edit” button you can change name to the object.

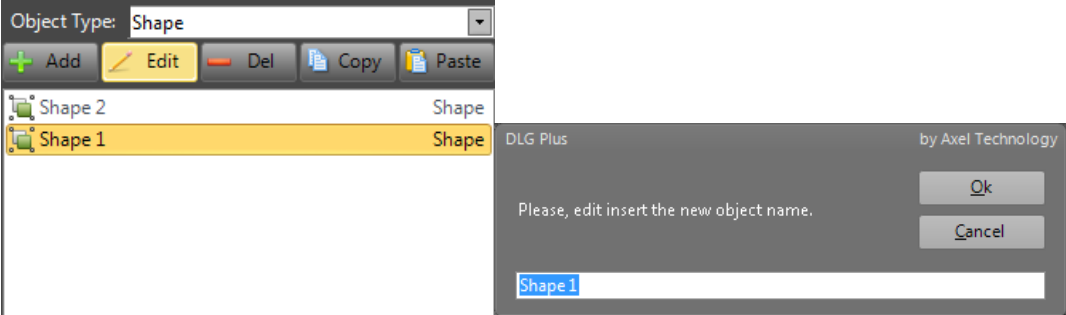

Do it for both the objects. This will help you to maintain the project well organized.

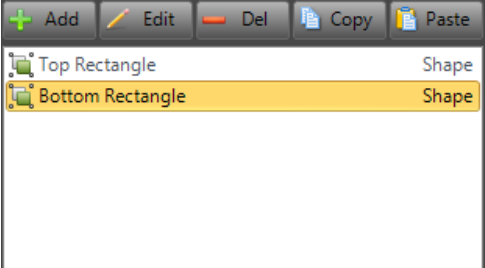

Then open the Align menu and move the second rectangle to bottom.



When you start pressing the button you will see the second rectangle moving down following the safe area guides.

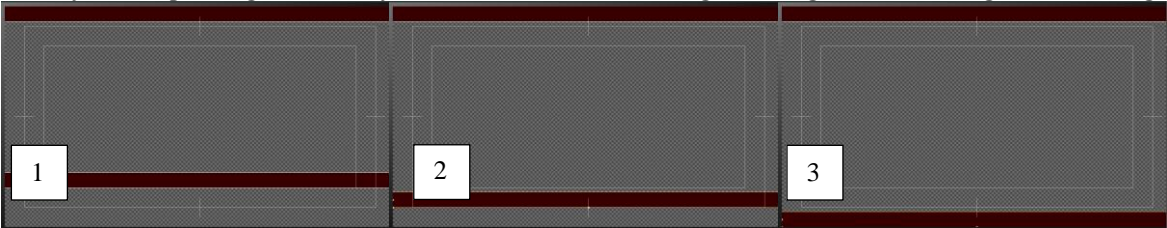

The rectangle will be placed at the end of our screen.

In the object list, select a Crawl then press “Add”

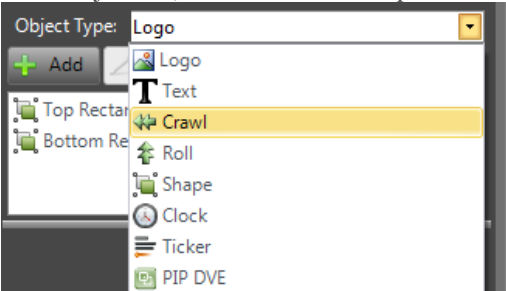

Go to your desktop and create a folder. Rename it as “NEWS”.

Open excel and create a new file saving it as “Stocks.xlsx” inside your “NEWS” folder.

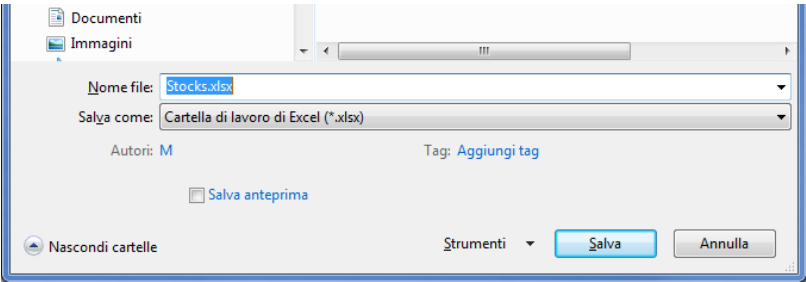

Back to DLG PLUS and inside the Crawl properties, we're going to select where we get the data from

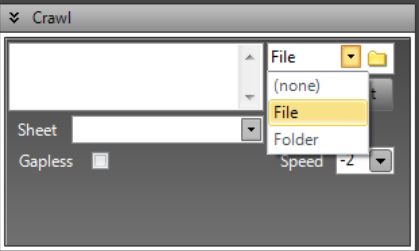

Select your "Stocks.xlsx" file!

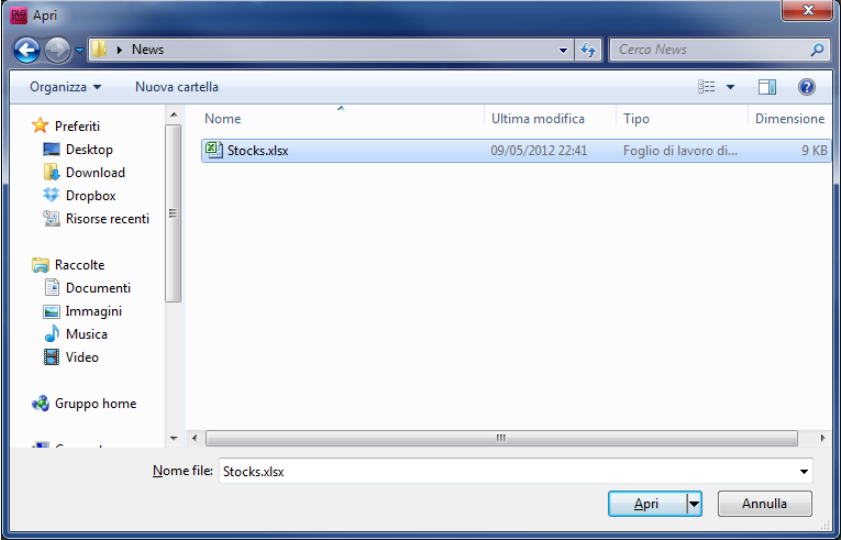

Set Color for text and color for the background inside the specific menus

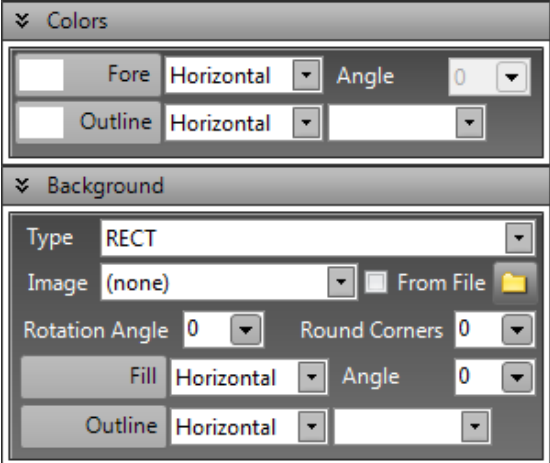

As we did before, select "Foreground" and then "More Color" and type the following parameters

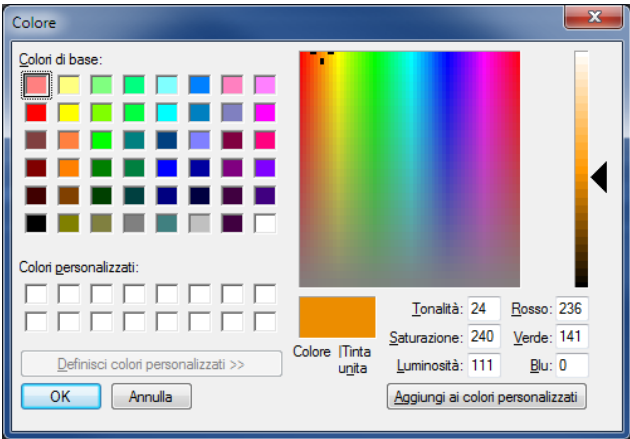

Same for the background, choosing a simple black from the color preset palettes

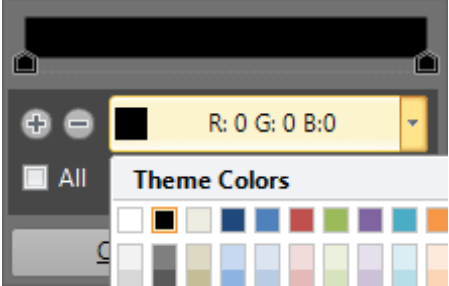

Set the position where you want to put your crawl

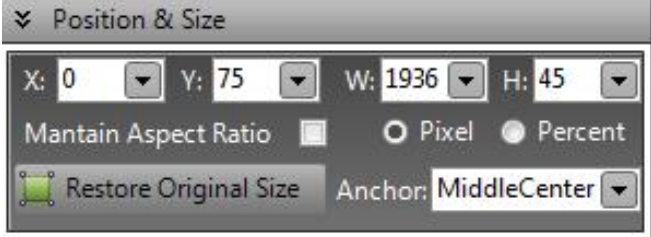

And this will be the result!

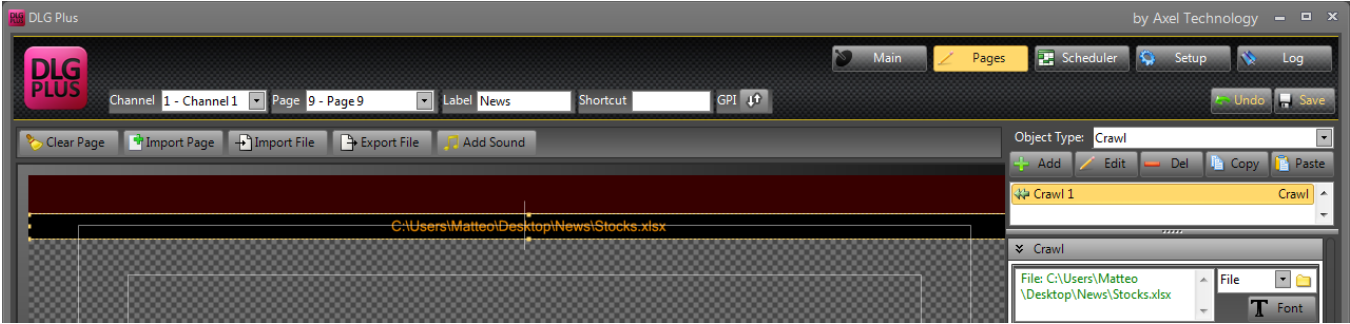

Then, open your excel file and start to insert data.

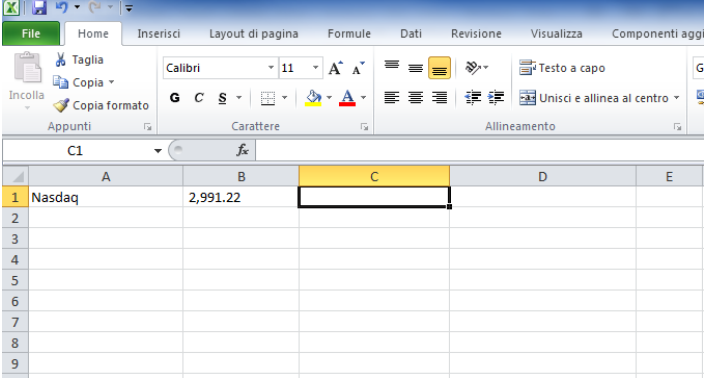

Each column will be filled with the value that will compose our crawl.

In the column “C” we are going to insert the image that will represent the trend (positive or negative) of our “Nasdaq”.

Return to the desktop and copy inside the “NEWS” folder two *.png images that you can create with any graphic software (or find them on internet!). Mine are 355 x 426 pixel, Dlg Plus will take care to resize them inside the crawl!

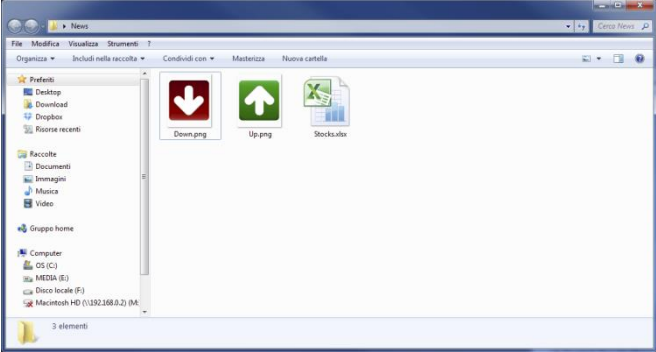

Back to Excel and put the name with the extension *.png of your image, then type the value in the next column.

	A	B	C	D
1	Nasdaq	2,991.22	up.png	+0.23%
2				

Repeat the process for all the rows on stocks you want to show on tv!

	A	B	C	D
1	Nasdaq	2,991.22	up.png	+0.23%
2	Dow	12,715.90	down.png	-1.65%
3	S&P 500	1,358.59	down.png	-1.71%
4	FTSE 100	5,608.18	up.png	+0.10%
5	STOXX 50	2,346.14	up.png	+1.06%
6				

Back to Dlg Plus and press “Take PRG” and you will see the crawl appear on screen with all the information typed on Excel.

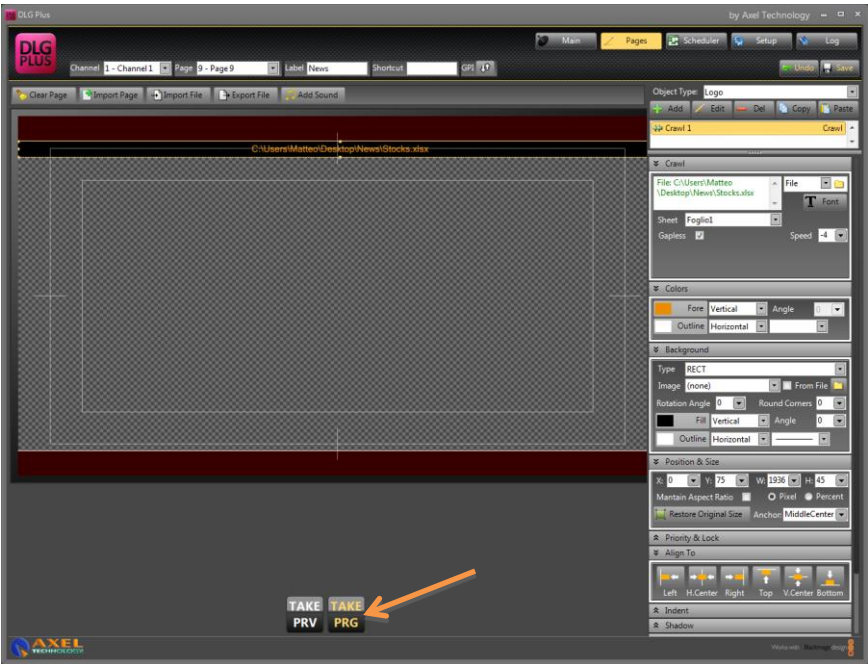

Watch the screen!!!

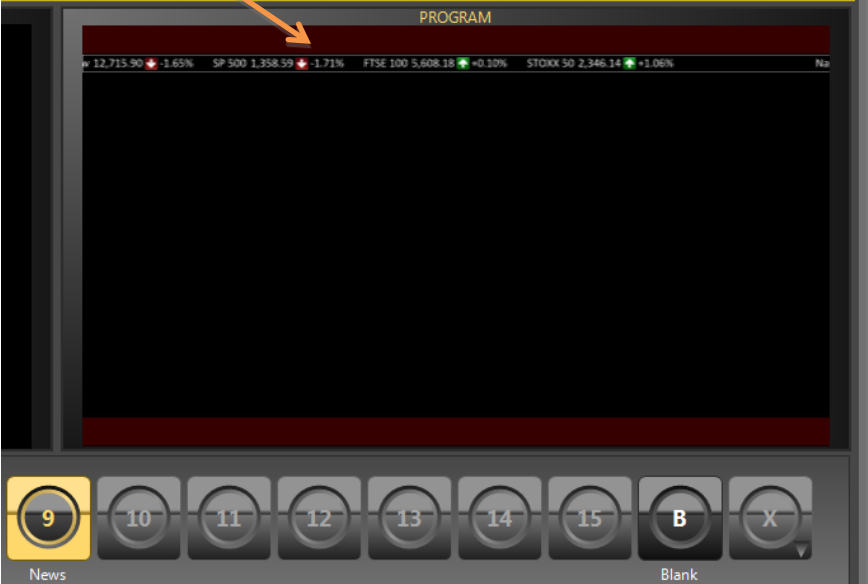

Copy and Paste the "Crawl" object (like we did for the dark rectangle at the beginning of this tutorial) and set a new position

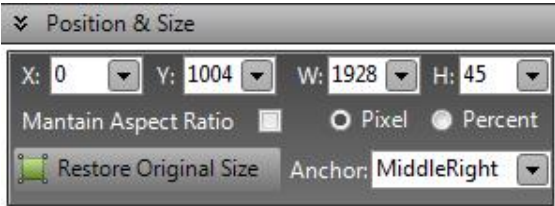

Create a new excel file, always inside your "News" Folder and name it "5News"

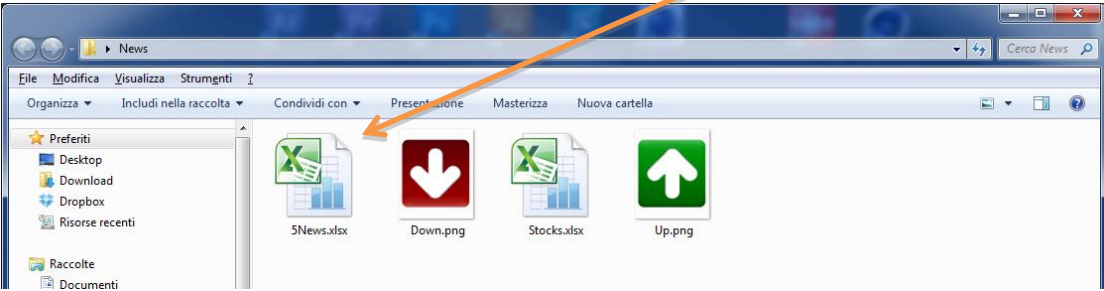

Inside this new crawl we are going to put, between one news and the next one, an animated globe. So, we will copy our animation inside the "NEWS" Folder. You can copy a small *.gif or *.swf animation of your News Logo, or Tv Channel.

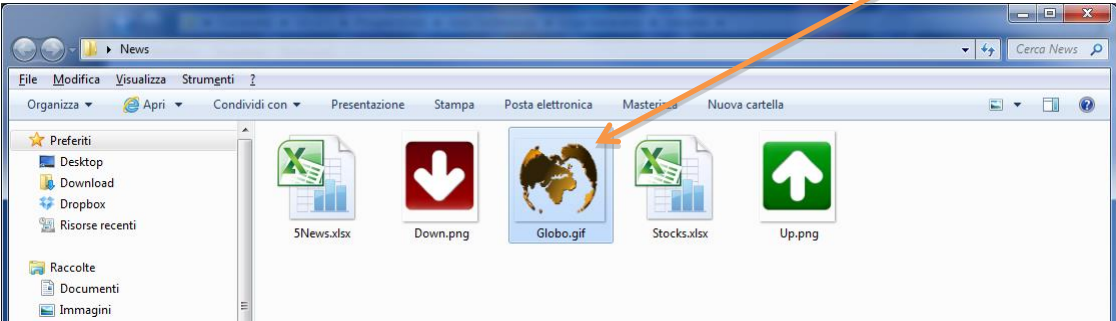

Open the "5News" excel file and start type your text putting a news for each line, alternate with the animation!

	A2		f _x	globo.gif	
	A	B	C	D	E
1	HOW CLOSE? OBAMA-ROMNEY CONTEST COULD COME DOWN TO FOUR STATES				Your News
2	globo.gif				Animation
3	CHINA CALLS FOR IMMEDIATE CEASEFIRE IN SYRIA AS DEADLINE NEARS				Your News
4	globo.gif				Animation
5	ATTORNEYS SAY ZIMMERMAN IS ISOLATED, STRESSED OUT				Your News
6	globo.gif				Animation
7	NORTH KOREA NAMES KIM JONG EUN TO NEW PARTY POST				Your News
8	globo.gif				Animation
9	BATTLES RAGING ON DISPUTED BORDER, TWO SUDANS SAY				Your News
10					
11					
12					

Create a new "Clock" object

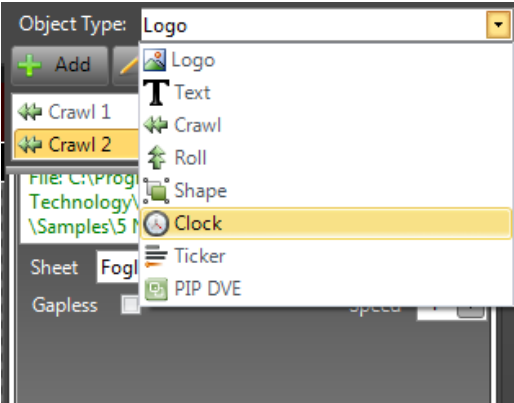

Set Format “dd/MM hh:mm” and position

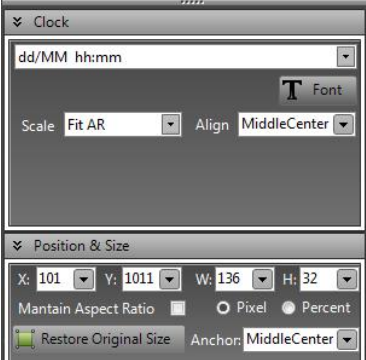

Set Colour for the text and for the background you want to show behind the clock: black for the text and a gradient with a small outline on the background.

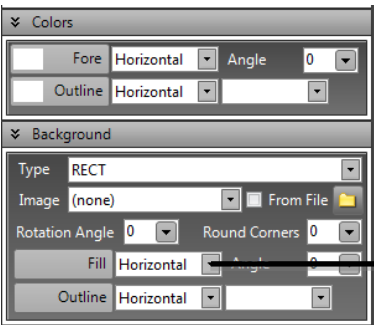

Set the Direction of the gradient

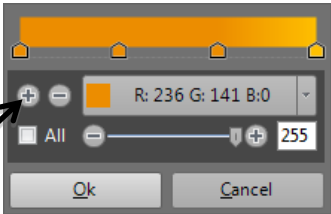
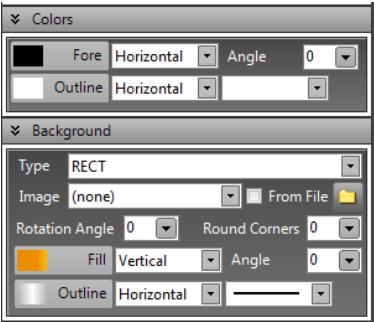

Use a light orange in this point!

Add Color Point using the Plus

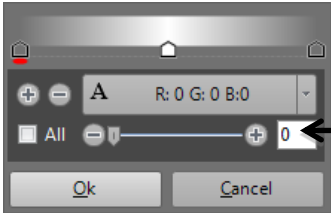

Transparent

BIG FEATURES!

You can set a color also in Excel and put it onair! Any cell could be customized with a specific color; You can do it to highlight a Breaking news for example.

	A
1	HOW CLOSE? OBAMA-ROMNEY CONTEST COULD COME DOWN TO FOUR STATES
2	globo.gif
3	CHINA CALLS FOR IMMEDIATE CEASEFIRE IN SYRIA AS DEADLINE NEARS
4	globo.gif
5	ATTORNEYS SAY ZIMMERMAN IS ISOLATED, STRESSED OUT
6	globo.gif
7	NORTH KOREA NAMES KIM JONG EUN TO NEW PARTY POST
8	globo.gif
9	BATTLES RAGING ON DISPUTED BORDER, TWO SUDANS SAY
10	

Now we are going to create the three "Ticker Boxes" that will appear on the side of the anchor woman!



Create a new rectangle shape with this properties:

Shape properties panel showing:

- Type: RECT
- Image: (none)
- Rotation Angle: 0
- Round Corners: 0
- Gamma Correction:
- Colors: Fore: [Color Picker]
- Outline: Horizontal
- Background: Type: RECT, Image: (none), Rotation Angle: 0, Round Corners: 0, Fill: Horizontal, Angle: 0, Outline: Horizontal
- Position & Size: X: 1505, Y: 161, W: 320, H: 255, Anchor: MiddleCenter

Opacity dialog box showing:

- Color Properties: R: 0 G: 0 B: 0
- Opacity: 163
- Buttons: Ok, Cancel

Copy and paste the same object twice and define position

<p>RECTANGLE 2</p> <p>Position & Size</p> <p>X: 1505 Y: 420 W: 320 H: 255</p> <p>Maintain Aspect Ratio <input type="checkbox"/> Pixel <input type="radio"/> Percent <input type="radio"/></p> <p>Restore Original Size Anchor: MiddleCenter</p>	<p>RECTANGLE 3</p> <p>Position & Size</p> <p>X: 1505 Y: 700 W: 320 H: 255</p> <p>Maintain Aspect Ratio <input type="checkbox"/> Pixel <input type="radio"/> Percent <input type="radio"/></p> <p>Restore Original Size Anchor: MiddleCenter</p>
--	--

Create a new "Text" object

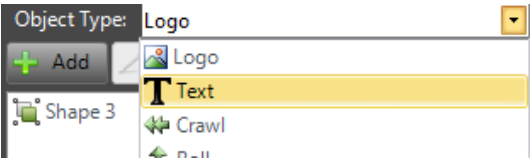

and apply these settings:

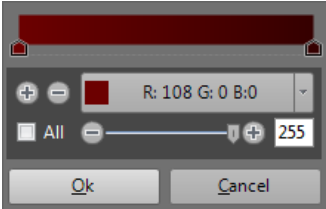
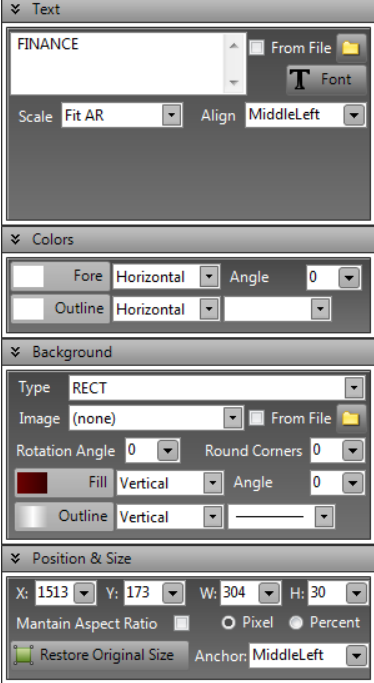

Copy and Paste the "Text" object twice and set new position and names:

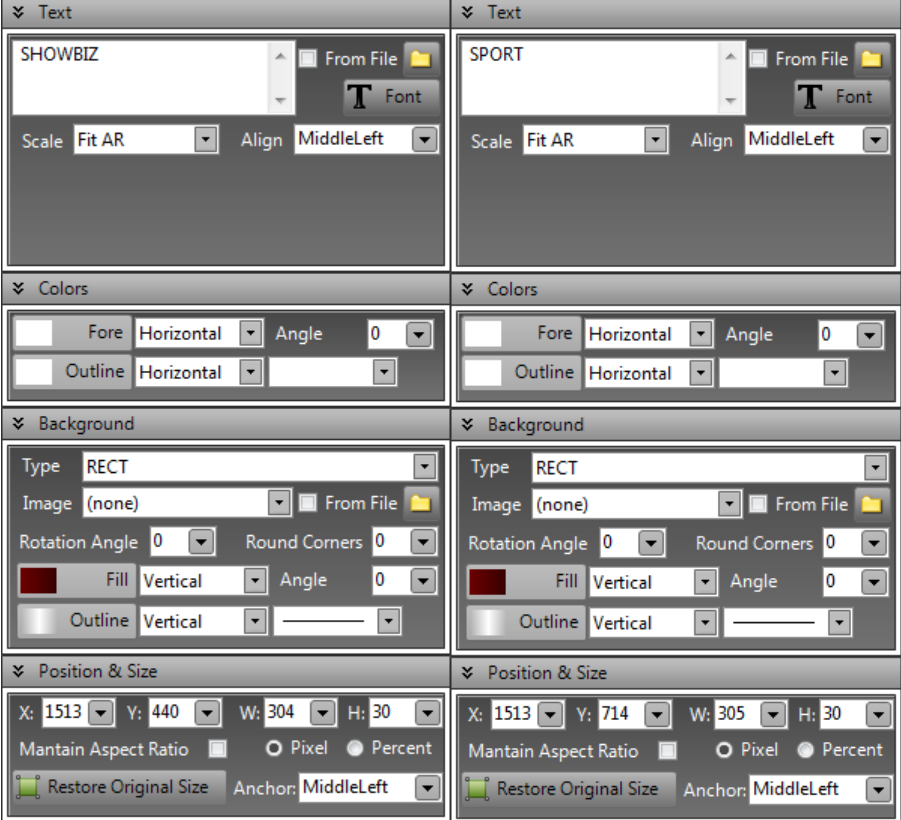

Create a new "Ticker" object inside your page

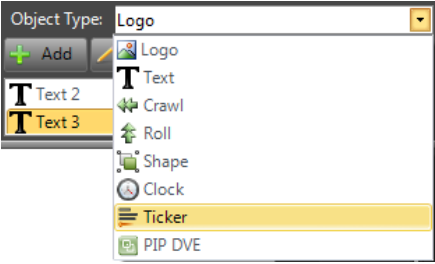

Create a new Excel file named "Ticker" and save it inside the "NEWS" folder

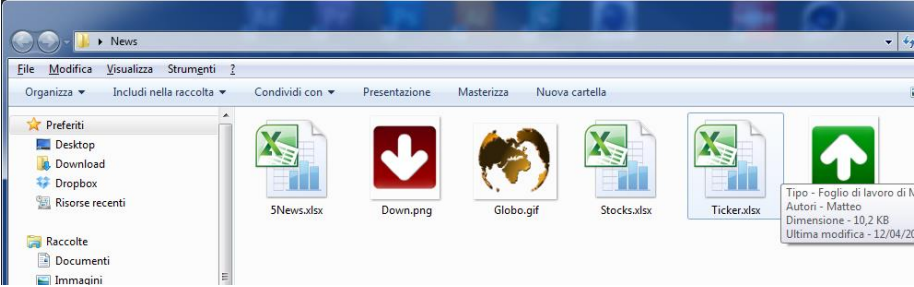

Open it and Create three different "Sheet", one for Finance, One for Showbiz and one for Sport

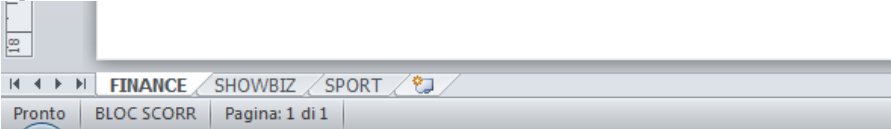

Select your "Ticker.xlsx" file and set this properties

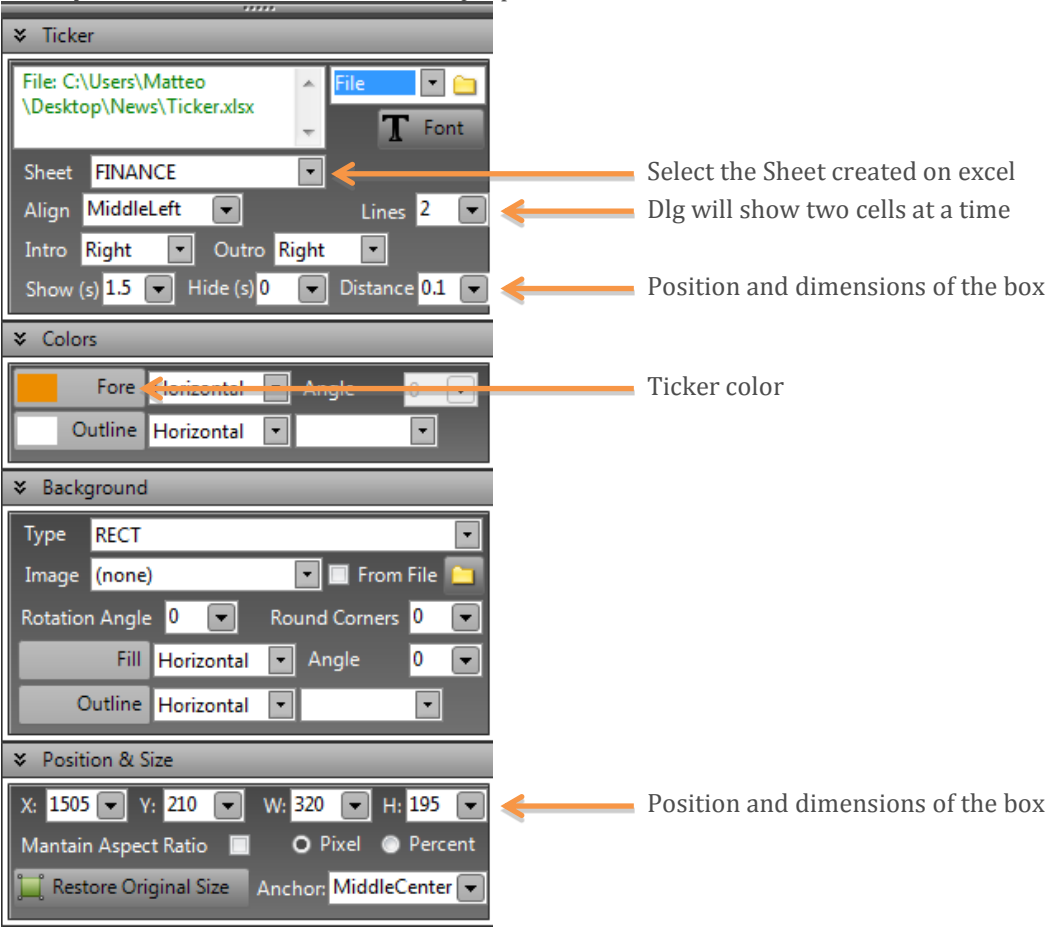

Do the same for the other two tickers you have to create:

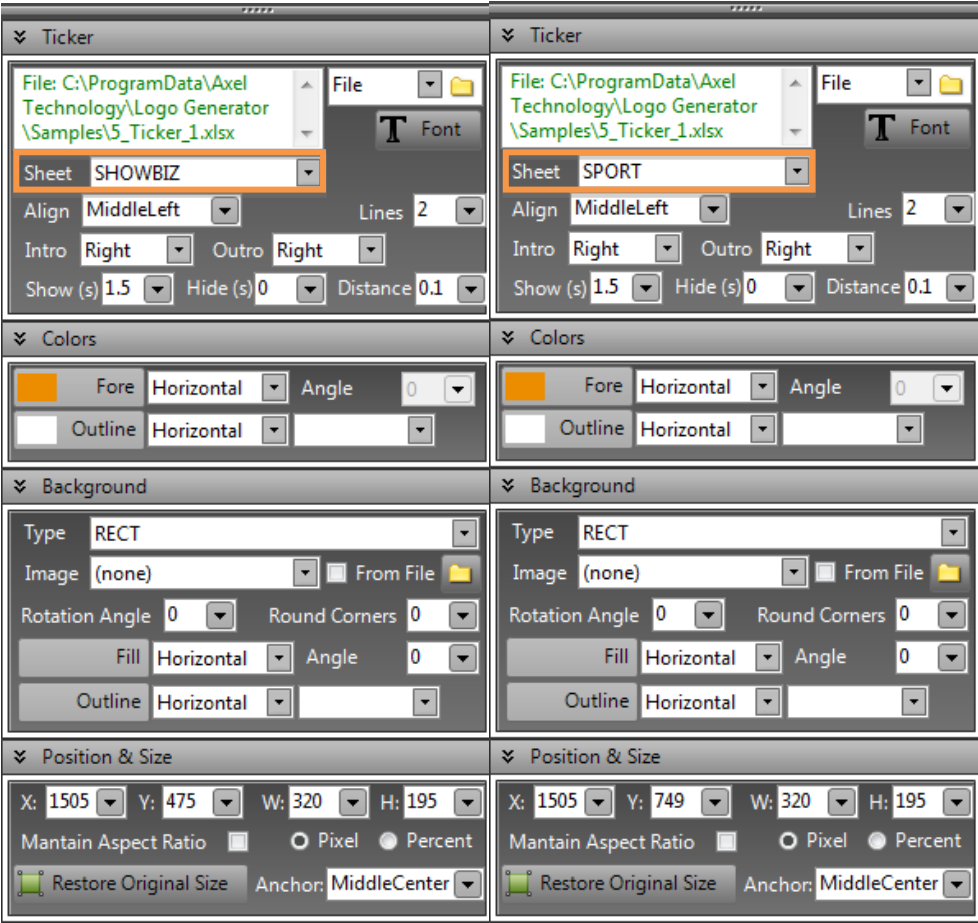

Copy the images you will use in your ticker always inside the “NEWS” Folder, then, open your excel and start to create your content for each category you’ve created previously!

1	finance_1.png DISORDERLY GREEK DEFAULT WILL COST EUROZONE 1€ TRILLION.	← On the first row, put your image
2		← In the second, put the news
3		← Leave one row empty to help your eyes!
4	finance_2.png OIL NEAR \$120, EDGES UP FROM TWO-MONTH LOW	
5		
6		
7	finance_3.png CREDIT SUISSE OPENED VOLATILITY BETS TO MAIN STREET.	
8		
9		
10		

Create an infinite number of news using this simple method. This is the result!

Do the same for the the other categories “Shobiz” and “Sport”.

Back to DLG Plus and save the page. Your 24/7 graphic is ready!
In the “Main” section you’re now able to go on-air with a broadcast quality news template giving to your programme an International Tv Network feeling.



5 RESTORE

DLG Plus is provided with a procedure for performing a FACTORY RESTORE on your device in case of need.

ATTENTION: With this procedure, all your data in the C:\ drive will be erased, so we suggest to make a backup copy of the data you want to save before starting with the restore.

After the restore, in the S:\ drive you will find the installation files and drivers for configuring again DLG's environment.

5.1 PROCEDURE

When starting the device, you can choose between two options:

- **Windows Embedded Standard** (default)
- **Axel Factory Restore**

Select "Axel Factory Restore" and press [ENTER]: a window will appear with the disclaimer conditions and reminding you of making a copy of your data before performing the restore, please read all carefully.

Click on "Reboot" to restart the device and make a backup copy of your data, otherwise tick "I accept all disclaimer conditions" and click on "Restore".

A window will appear asking you to enter a password with the format "axelrestoreXXXX", please contact Axel Technology's technical support who will provide a valid password.

Insert the password and click on OK to start the restore process.

5.2 DLG PLUS SETUP

Once the device has been restored, you can reinstall DLG Plus by the installation file you find in S:\Setup\AxelUpdate.

Run the "DLGPlusSetup.exe" file:

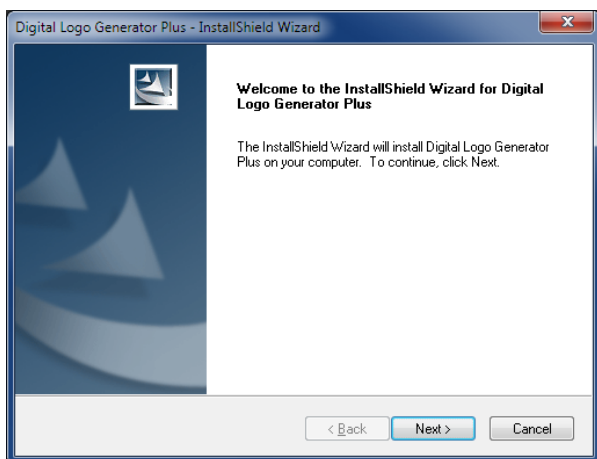

Click on "Next" button:

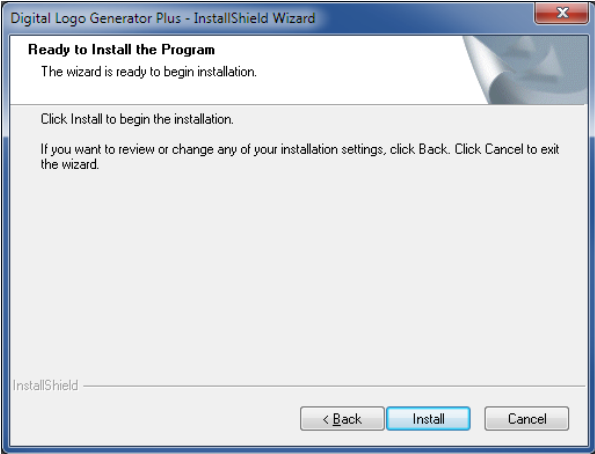

Then, click on "Install" button:

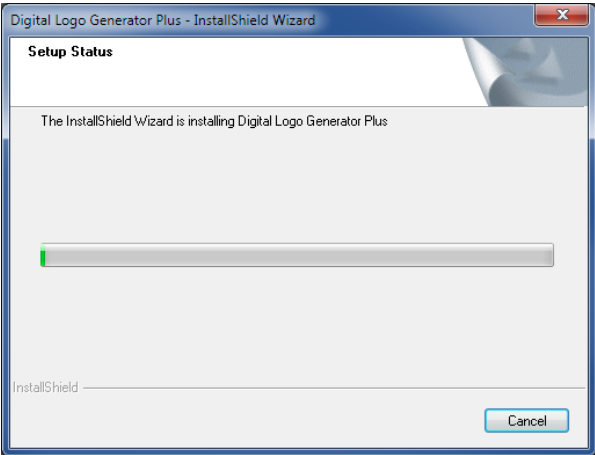

When the DLG installation finishes, click on "Finish" button:

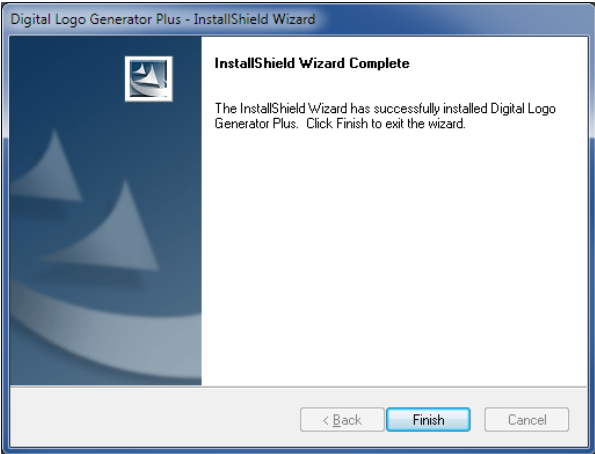

Now, Axel Multimedia Pack is going to be installed automatically:

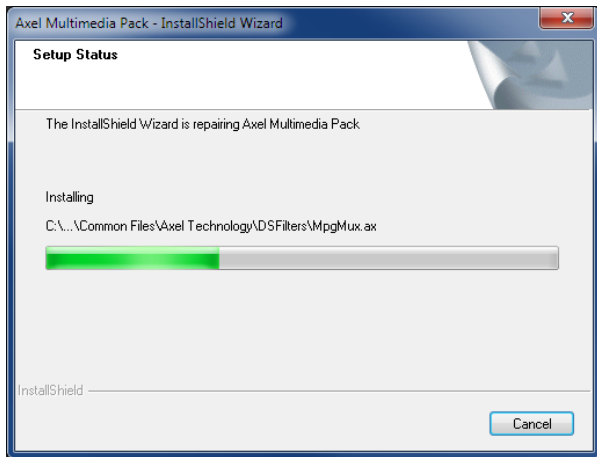

When Axel Multimedia Pack installation finishes, please set the check on “No, I will restart my computer later” and then click on “Finish” button:

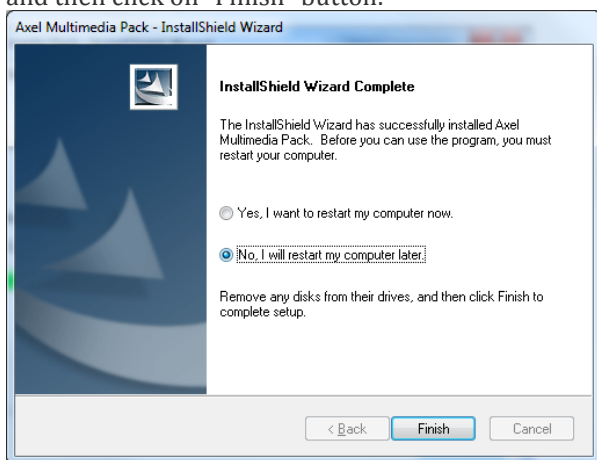

Now, DLG Plus software is installed on you pc!

5.3 HARDWARE KEY

DLG Plus works with a USB hardware key plugged in the internal USB port of the device. **If the hardware key is not detected by the system, DLG Plus will work on Demo Mode.**