

TCP Link for ATEM

User Manual

September 27, 2025

SKUs: TCP-LINK-4ATEM-V2

Language: English



I Disclaimer

Before using this product, please read and fully understand all instructions provided. This product is classified as Class A equipment and is intended for use by commercial customers only. It is not suitable for residential use and may cause interference in residential environments.

For the most up-to-date specifications, refer to the latest SKAARHOJ data sheets or publications. Availability of products and types may vary by country —please check with a SKAARHOJ sales representative for details.

The information in this document is subject to change without notice. While SKAARHOJ strives to ensure the quality, reliability, and safety of its products, defects cannot be entirely ruled out. To minimize risks of damage or injury, customers must implement appropriate safety measures and follow the intended use guidelines.

SKAARHOJ and its subsidiaries disclaim any liability, warranty, or responsibility for claims, whether in contract, tort, or any other legal theory. SKAARHOJ shall not be liable for any special, direct, indirect, incidental, or consequential damages, including lost profits, revenues, or economic losses, or for third-party claims, equipment replacement, or any other damages.

SKAARHOJ does not assume liability for patent, copyright, or intellectual property infringement arising from the use of its products. No license or rights are granted under any patents or intellectual property of SKAARHOJ or third parties.

If any of the above clauses are not permitted by applicable law, they will be enforced to the maximum extent allowed.

II Imprint

© 2025 SKAARHOJ. All rights reserved.

This device contains proprietary information of SKAARHOJ and is provided under a license agreement with restrictions on use and disclosure, protected by copyright law. Reverse engineering of the hardware and software is prohibited.

No part of this publication may be distributed, reproduced, transmitted, transcribed, stored in a data retrieval system, or translated into any language in any form by any means without prior written permission from SKAARHOJ.

If you download files from our website for personal use, ensure you check for updated versions. SKAARHOJ cannot be held liable for downloaded files, as technical data is subject to change without notice.

Due to ongoing product development, the information in this document may change without notice. The information and intellectual property contained herein is confidential between SKAARHOJ and the client and remains SKAARHOJ's exclusive property. Please report any issues with the documentation in writing. SKAARHOJ does not guarantee this document is error-free.

The source language of this manual is English. Translations into other languages are derived from the English version.

For further assistance:

SKAARHOJ ApS
Rosenkaeret 11C
DK-2860 Soeborg
Denmark
Email: info@skaarhoj.com
Website: www.skaarhoj.com

II.1 Trademarks

SKAARHOJ® is a registered trademark of SKAARHOJ ApS. The following names are also trademarks of SKAARHOJ: Raw Panel™, Blue Pill™, Reactor™, UniSketch™, Device Core™, and TCP Link for ATEM™.

All other trademarks are the property of their respective owners and are acknowledged as such.

III Document Legends

This section explains the meaning of various alert levels and informational notes used throughout this document. Each label serves as a guide to indicate the level of attention required and the type of risk involved. Please review these legends carefully to ensure a clear understanding of the warnings, cautions, and helpful tips provided.

Danger

DANGER indicates an imminent hazard. Failure to avoid it will result in death or serious injury. Always follow the recommended actions to prevent this danger.

Warning

WARNING indicates a potential hazard. Failure to avoid it may result in death or serious injury. Always follow the recommended actions to prevent this risk.

Caution

CAUTION indicates a possible hazard. Failure to avoid it may result in minor or moderate injuries. Always follow the recommended actions to prevent this hazard.

Notice

NOTICE indicates a potential risk of equipment or environmental damage. Always follow the recommended actions to avoid damage.

Hint

HINT provides additional information to clarify or simplify a procedure. It is not related to safety.

Contents

I Disclaimer	1
II Imprint	2
II.1 Trademarks	2
III Document Legends	3
1 About this Document	5
2 Safety Information	6
3 About TCP Link for ATEM	7
3.1 Feature Highlights	7
3.2 Intended Use	7
3.3 Product Identification	8
3.4 Environmental Conditions	8
3.5 Technical Data and Dimensions	8
3.5.1 Standard Connections	8
3.5.2 Protective Earth	9
3.5.3 Technical Drawing	9
3.5.4 Technical Data	9
3.6 Scope of Delivery and Warranty	10
3.6.1 Recommended Accessories	11
3.7 Certification and Safety Standards	11
3.7.1 EU Declaration of Conformity	11
4 Getting Started with Link IO	12
4.1 Quick Steps	12
4.2 SKAARHOJ Discovery	12
4.3 Configuration via USB	13
4.4 Accessing the Web Interface	15
4.4.1 Network Settings	16
4.5 Firmware Updates	18
4.5.1 New Firmware Releases	18
4.5.2 Factory Reset	20

4.5.3	Wrong Firmware	20
4.5.4	Upgrading to the Link IO Platform	22
5	TCP Link for ATEM Functionality	26
5.1	Settings Tab	27
5.2	TSL Tab	28
5.3	HTTP Tab	29
5.4	Control Tab	31
6	Service	32
6.1	Troubleshooting	32
6.2	Cleaning	32
6.3	Repair	33
6.4	Disposal	34
6.5	Transportation and Storage	34
6.6	SKAARHOJ Service Contacts	35
7	Notes	36

1 About this Document

This operating manual is intended for all users of the SKAARHOJ TCP Link for ATEM. It provides essential guidelines for safe and proper operation of the device. All users must read this manual before using the device for the first time to ensure correct usage.

The manual is an important part of the TCP Link for ATEM and should be kept easily accessible, close to the device for reference at any time.

For more detailed information about the device's features and functionality, please refer to additional instructions available for download at www.skaarhoj.com or request them via support@skaarhoj.com.

Ensure that the operating manual, user manual, and any other relevant documentation are stored safely for future reference and for any potential future users of the device.

For more resources and helpful information, visit the SKAARHOJ website.

SKAARHOJ offers comprehensive training courses to provide deeper insights into maximizing the potential of SKAARHOJ products.

2 Safety Information

This safety information supplements the specific operating instructions and must be strictly followed. Before operating or installing the device, read and understand all safety and operating instructions. Keep these instructions for future reference. Always follow the guidelines in this and any other documentation provided to avoid injury or damage to the device and surrounding objects.

Assembly and operation should only be performed by trained personnel familiar with the device. Use only the recommended tools, materials, and procedures outlined in this document. For other equipment, refer to the manufacturer's instructions.

Safety instructions, warning symbols, and signal words in this document highlight different levels of risk.

Caution

Using TCP Link for ATEM in Humid Environments with Condensation

When moving the device and its accessories from a cool to a warm location, or when used in a damp environment, condensation may form inside the device and on electrical connections. Do not operate the device while condensation is present, as it poses a risk of electric shock and fire due to short circuits.

- Do not use the device or accessories if condensation occurs.
- After moving the device from a cool to a warm environment, allow time for the components to warm up.
- Store the device in a warmer location to reduce the risk of condensation.

Warning

Connected Cables on the Floor

Risk of injury from tripping, falling, or slipping over connected cables.

- Always secure cables connected to the device and accessories properly.
- Install cables in a way that prevents tripping.
- Use a cable duct or secure cables with adhesive tape if necessary.
- Always disconnect cables from the device and accessories before moving them.

3 About TCP Link for ATEM

SKAARHOJ's TCP Link for ATEM fills the crucial need for a TCP interface with BlackMagic Design ATEM switchers, enabling easy integration into AV systems. This innovative tool reports state changes and forwards commands to the switcher, ideal for AV projects involving systems like Crestron and Extron. It simplifies the command process, showing in the terminal how commands appear, to replicate them effectively. Based on the UniSketch platform, it's a must-have for seamless switcher control and integration in diverse AV setups.

With TCP Link for ATEM you enjoy benefits such as

- Provides a TCP interface for BlackMagic Design ATEM switchers, enabling easy AV system integration.
- Reports switcher state changes and forwards commands, enhancing control and responsiveness.
- Facilitates seamless integration with major AV systems like Crestron and Extron.
- Simplifies the command process for effective switcher management.
- Based on the UniSketch platform, ensuring reliability and wide compatibility.

3.1 Feature Highlights

- Seamless integration with Blackmagic Design ATEM switchers
- Control over TCP/IP for streamlined operations
- Ethernet connectivity with Power over Ethernet (PoE)
- Simplifies the ATEM integration with any 3rd party system
- Durable build quality for professional use
- Designed and manufactured in Denmark

3.2 Intended Use

Notice

Intended Use of TCP Link for ATEM

All versions of TCP Link for ATEM, and accessories are intended for professional use only and must be operated by skilled and trained personnel in non-domestic environments. They must not be used by inexperienced individuals without proper training.

Before use, carefully read and understand both the operating and user manuals. Use the product and its accessories solely for the purposes outlined in this document. Always follow the safety instructions and system requirements for all equipment involved.

SKAARHOJ assumes no liability for damages or modifications resulting from improper use. Modifying the product or its accessories is strictly prohibited.

3.3 Product Identification

The TCP Link for ATEM is identified by a label located on the bottom of the device. This label contains important information such as certification marks, product code, and the serial number. Ensure this label remains intact for future reference and support.

3.4 Environmental Conditions

The TCP Link for ATEM must be used and stored under specific environmental conditions. Before commissioning and operation, ensure the following conditions are met:

Operating Temperature	0° C to +40° C / +32° F to +104° F
Storage Temperature	-20° C to +45° C / -4° F to +113° F
Humidity	90% RH, non-condensing, from -20° C to +45° C

3.5 Technical Data and Dimensions

3.5.1 Standard Connections

On most SKAARHOJ products, you will find the following cable connections on the backside:

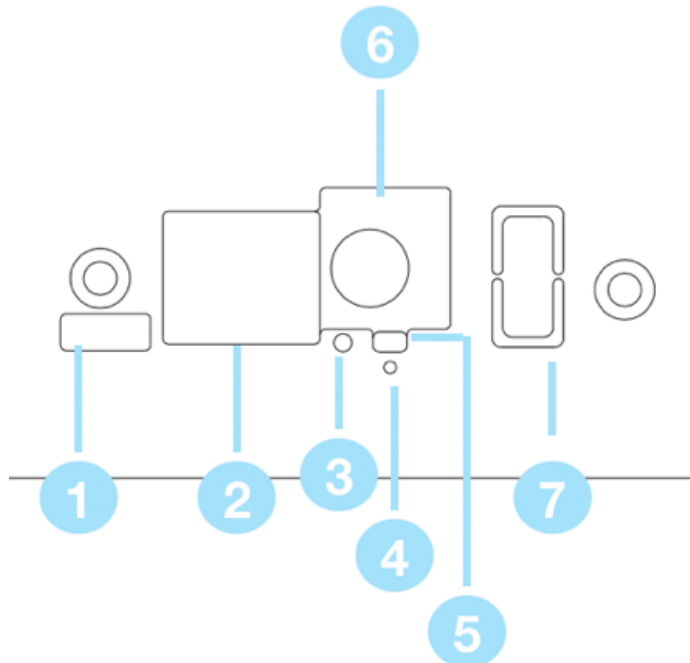

- **1:** Micro USB Port for serial communication with SKAARHOJ Firmware Updater
- **2:** IP Network RJ45 Port for IP control and 5W-30W PoE (+)/PoE Standard: IEEE 802.3af/t
- **3:** Status LED for monitoring and debugging
- **4:** Not used on Blue Pill Inside products.
- **5:** Config Button to enable WiFi Access Point. See WiFi Access Point section
- **6:** 12V DC Power Supply for connection to the supplied DC power adaptor. Center is positive.
- **7:** USB-A Port. Only available on some models for attachment of accessories.

Notice

- Use only shielded Cat6 (STP) cables for Ethernet connections.
- Ensure that your Ethernet switch is properly connected to a protective earth ground.
- All cables, except Ethernet and GPI cables, must be shorter than 3 meters.
- If applicable: The USB-A port's power is not included in the product's maximum power rating. If near maximum load, use a powered USB hub to prevent the USB-A port from impacting the overall power budget.

3.5.2 Protective Earth

Proper grounding of the device in its installation space is highly recommended. In most cases, grounding the unit through a shielded Ethernet cable connected to a properly grounded switch will suffice. However, to fully comply with all immunity standards, more direct grounding may be necessary. If required, attach a protective earth ground wire to the screw located just above the Micro USB port.

3.5.3 Technical Drawing

Figure 1 presents a detailed technical drawing of TCP Link for ATEM, highlighting key dimensions and design elements.

3.5.4 Technical Data

Technical data for TCP Link for ATEM are presented in Table 1.

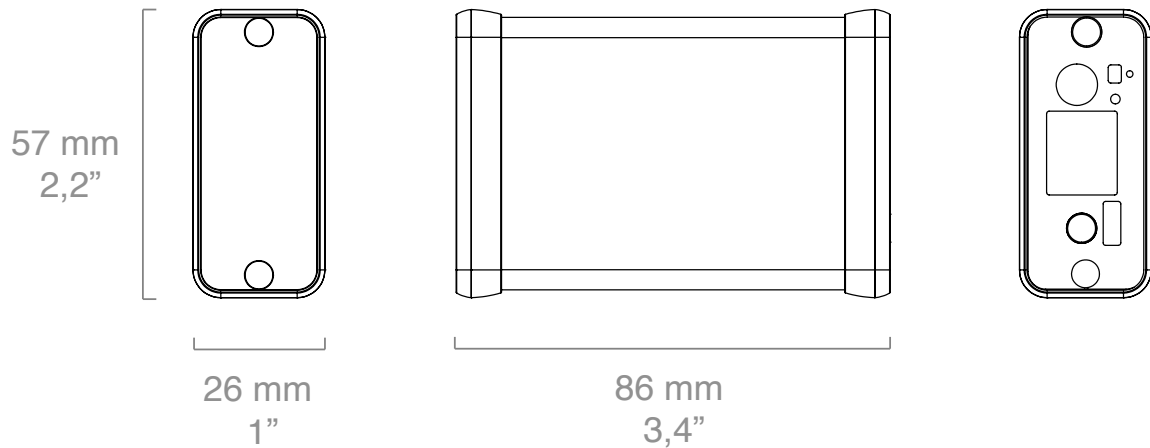

Figure 1: Technical drawing of TCP Link for ATEM with key dimensions and layout details.

Connectivity	
Networking	100 Mbit Ethernet w/Power over Ethernet (PoE IEEE802.3af)
Power Supply	12V DC Jack 5.5mm x 2.1mm x 10mm Center Positive PoE IEEE802.3af/t
Service Port	Micro USB for updating firmwares and setting manual IP
Software	
Platform	Link IO
Licenses	N/A
Physical and Shipping	
Product Weight	90 g
Shipping Box Weight	419 g
Country of Origin	Denmark

Table 1: Detailed specifications and technical characteristics for TCP Link for ATEM

3.6 Scope of Delivery and Warranty

Notice

Important Information:

The packaging materials are recyclable. To contribute to environmental sustainability, please dispose of the packaging at a certified recycling facility. Ensure that all storage, shipping, and disposal comply with local regulations. SKAARHOJ assumes no responsibility for any consequences arising from improper storage, shipping, or disposal of the product.

Upon receiving the delivery, carefully inspect the package and its contents for any signs of damage or missing components. Do not accept the delivery if the package is damaged or incomplete. The package should contain the following items:

- (This Product)

- 12V Power Supply: Manufacturer: PHIHONG, Model Name: PSA15R-120P, Output: 12V/1.25A, Cable Length: 1.5m, Adapter type: EU, GB, US, AU depending on shipping country, DC Output Connector: 5.5mm x 2.1mm x 10mm Center Positive
- Micro USB Cable
- Getting Started Guide

For details regarding the warranty, please contact your local SKAARHOJ Service Partner. SKAARHOJ is not liable for any issues arising from improper shipping, misuse, or the use of unauthorized third-party products.

3.6.1 Recommended Accessories

- Ethernet Cable: Cat 6 S/FTP or better

3.7 Certification and Safety Standards

3.7.1 EU Declaration of Conformity



Brand Name

Product Description

SKAARHOJ
Universal Control Panel
TCP Link for ATEM

4 Getting Started with Link IO

4.1 Quick Steps

Getting started with TCP Link for ATEM - your new Link IO accessory - is straightforward. The first step is to access its web interface. Follow these steps:

- **Connect the Link IO Device:** Plug a Cat6 (STP) or better Ethernet cable into your SKAARHOJ Link IO device and ensure it is connected to your local network.
- **Download SKAARHOJ Discovery:** Download the SKAARHOJ Discovery application from www.skaarhoj.com, then launch the application from your Mac or PC on the local network.
- **Connect via USB (if needed):** If the device does not appear automatically in Discovery, connect it directly to your Mac or PC using a USB cable.
- **Set IP Address:** In SKAARHOJ Discovery, switch to the On USB tab. Select your device, click the Change IP Address button, enter a valid IP address, and click Save.
- **Access the Web Interface:** Once your device has a valid IP address, it will appear under the On Network tab with an Open button. Click Open to launch the device's Web UI.

Notice

Screenshots from other Link IO Accessories

In this Getting Started section, some screenshots and illustrations may show other products from the Link IO Accessory series. This is because these devices share the same web interface and follow the same procedure for initial setup as the TCP Link for ATEM.

While the appearance of the screenshots may differ slightly depending on the specific accessory, the steps and configuration principles are identical.

4.2 SKAARHOJ Discovery

When you launch the SKAARHOJ Discovery application, it automatically scans your local network for connected SKAARHOJ devices. If DHCP is enabled, the Link IO device will obtain an IP address automatically out of the box, and SKAARHOJ Discovery will display it in the device list. In the example below, the Link IO accessory is an ETH-SDI Link. Clicking on the device will display details on the right side of the screen.

You can also click the Open button for the device to launch its web interface, where you can set IP addresses and configure device-specific settings.

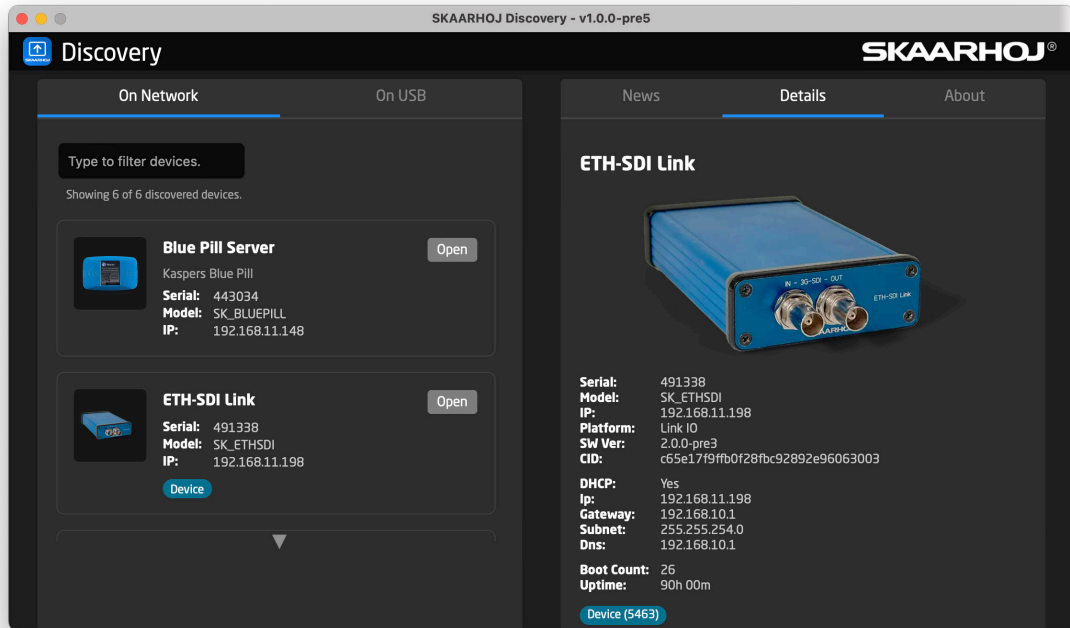

In some cases, your Link IO device may appear in the Network tab but be grayed out, with no Open button available. This can happen if the device has an invalid IP address (e.g., 0.0.0.0) or an unreachable static IP. In that case, connect the device to your computer via Micro USB and assign a new IP address using the USB connection.

4.3 Configuration via USB

Connect the Link IO device to your computer using a Micro USB cable. Launch the SKAARHOJ Discovery application and switch to the On USB tab. Your device should appear in the list. Select it, then click the Change Network Settings button.

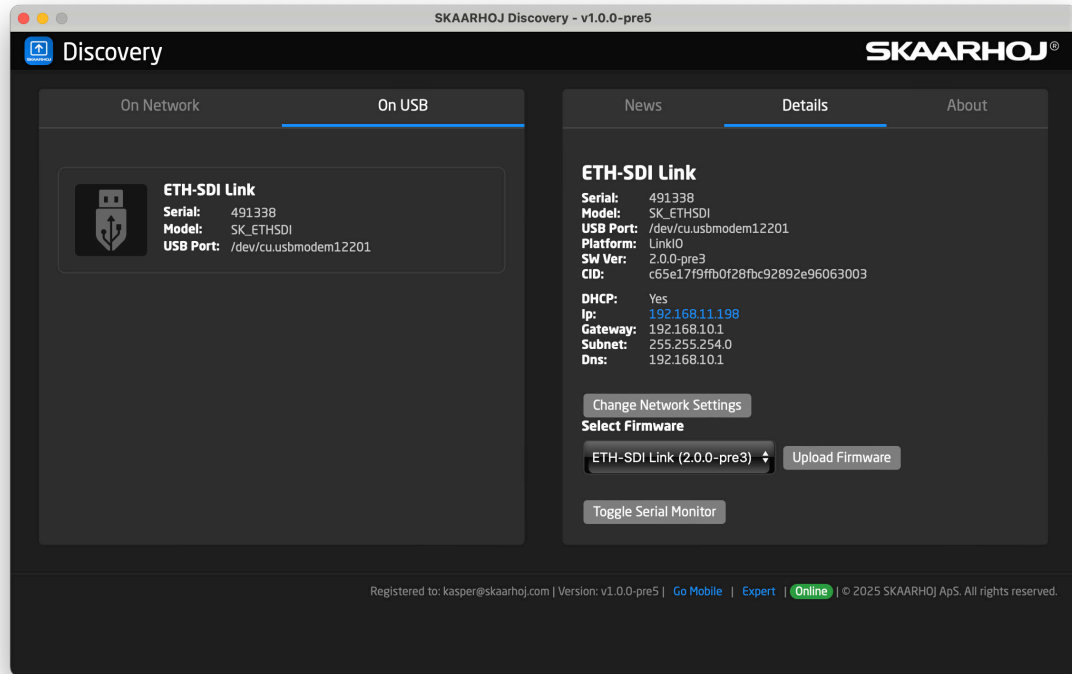

In the fields that appear, enter a static IP address for the device. Make sure to choose an address that is valid for your network and does not conflict with other devices.

The screenshot shows a 'DHCP' configuration dialog box. At the top, there is a toggle switch for 'Automatic IP assignment' which is currently turned off. Below this, there are three input fields: 'IP Address' with the value '192.168.11.198', 'Subnet Mask' with the value '255.255.254.0', and 'Gateway' with the value '192.168.10.1'. At the bottom of the dialog, there are two buttons: 'Update' and 'Cancel'.

After entering the desired IP address, click the Update button. The new settings will be applied and the device will reboot. Once the update is complete, switch back to the On Network tab to see your device listed with its new IP address.

4.4 Accessing the Web Interface

Once your Link IO device has a valid IP address, it will appear in the On Network tab of the SKAARHOJ Discovery application. Click the Open button next to the device to launch its web interface in your default web browser.

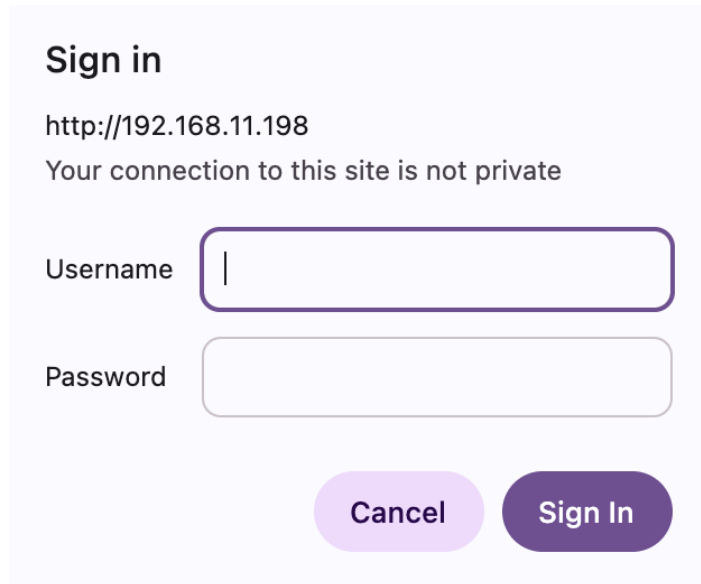

The screenshot shows a web browser window with the following content:

- Sign in**
- URL: `http://192.168.11.198`
- Warning: Your connection to this site is not private
- Username field:
- Password field:
- Buttons: **Cancel** and **Sign In**

You will be prompted to enter a username and password. The default credentials are:

- **Username:** admin
- **Password:** skaarhoj

Caution

Unencrypted Login Credentials

The username and password are transmitted in **unencrypted form** when accessing the Link IO Web UI:

- **Use only on trusted local networks.**
- **Do not expose the device directly to the internet** without proper network safeguards (e.g., VPN or firewall).
- **Be aware of potential security risks** if used on untrusted or public networks.

After logging in, you will see the main dashboard of the Link IO device. From here, you can configure network settings and other device-specific parameters. Below is an example of the dashboard interface from the Link IO device called ETH-SDI Link.

The screenshot displays the ETH-SDI Link web interface. The top navigation bar includes 'Network', 'Control', and 'About' tabs, with 'Network' selected. The right side of the interface has 'SDI', 'Raw Panel', 'TSL', and 'HTTP' tabs, with 'SDI' selected. The 'Network Settings' section on the left includes fields for Device Description (e.g., ETH-SDI Link 1), DHCP (Automatic IP assignment), IP Address (192.168.11.198), Subnet Mask (255.255.254.0), Gateway (192.168.10.1), and DNS (192.168.10.1). A Password field is also present with a 'Set new password' button. The 'SDI Settings' section on the right includes 'SDI Tally Out' (Default (Off until network data)) and 'SDI Control Out' (Default (On)). A 'Full Screen' button is located at the bottom right. The interface is dark-themed with white text and blue accents.

4.4.1 Network Settings

The **Network** tab allows you to configure how your Link IO device connects to your local network. Some of these settings could also be configured via the SKAARHOJ Discovery application over USB. You can assign a static IP address, enable or disable DHCP, and adjust related options for reliable communication.

The screenshot shows the 'Network Settings' page. At the top, there are three tabs: 'Network' (highlighted with a blue underline), 'Control', and 'About'. Below the tabs, the title 'Network Settings' is displayed. The settings are organized into several sections:

- Device Description:** A text input field containing 'e.g. ETH-SDI Link 1'. Below it, a note says 'Max 20 characters. Avoid symbols like quotes.'
- DHCP:** A toggle switch is currently turned off. To its right, the text 'Automatic IP assignment' is visible.
- IP Address:** A text input field containing '192.168.11.123', which is highlighted with a blue border.
- Subnet Mask:** A text input field containing '255.255.254.0'.
- Gateway:** A text input field containing '192.168.10.1'.
- Password:** A text input field containing 'Set new password'. Below it, a note says 'Up to 20 characters. Leave empty to keep current password.'
- Disable all mDNS advertisements:** A toggle switch is turned off. To its right, the text says 'Stops advertising services (Raw Panel, HTTP, etc.) via mDNS.'
- Enable Ethernet auto-negotiation:** A toggle switch is turned on (blue). To its right, the text says 'Let the PHY auto-negotiate speed/duplex (if supported).'
- Disable Web UI authentication:** A toggle switch is turned off. To its right, a warning says 'Warning: Anyone on the network can access the UI when disabled.'

At the bottom of the settings area, there are two green buttons: 'Save' and 'Save and Reboot'.

The following options are available:

- **Device Description:** Enter a custom name (up to 20 characters) for your device. This helps you identify it in SKAARHOJ Discovery or other network tools.
- **DHCP (Automatic IP Assignment):** When enabled, the device requests an IP address from your network's DHCP server (e.g., your router). Disable this option to set a fixed static IP address manually.
- **IP Address:** The unique network address of your device. If DHCP is disabled, enter a valid static IP address that matches your network range.
- **Subnet Mask:** Defines the network segment the device belongs to. For most local networks, this will be 255.255.255.0.

- **Gateway:** The IP address of your network's default gateway (typically your router). This setting is required if the device needs to communicate outside of the local subnet.
- **Password:** Allows you to change the device's web interface password. Leave this field blank to keep the current password. See below for a setting to disable password protection.

There are also several advanced options available in the Network Settings tab:

- **Disable all mDNS Advertisements:** Stops the device from broadcasting its presence on the network via mDNS (Bonjour/ZeroConf). Useful in large installations where reducing network traffic is important.
- **Enable Ethernet Auto-Negotiation:** When enabled, the device automatically negotiates the best possible speed and duplex mode with your network switch. Historically, this has not been enabled in SKAARHOJ devices, but it is now available for compatibility with modern network equipment.
- **Disable Web UI Authentication:** When enabled, anyone on the network can access the Web UI without logging in. **Use with caution**, as this disables password protection.

Once you have made the necessary changes, click **Save** to apply them, or **Save and Reboot** to restart the device with the new settings.

Notice

Save or Save and Reboot?

When you change settings in the Web UI, you can choose either **Save** or **Save and Reboot**:

- **Save:** Writes the new settings to the device's persistent memory. Some changes take effect immediately without requiring a reboot. This option is faster and suitable for parameters like labels or minor adjustments.
- **Save and Reboot:** Also writes the settings to persistent memory, but additionally restarts the device. A reboot is required for certain changes such as IP configuration, enabling or disabling network services, or changing communication ports. This option ensures that all changes are fully applied, but takes a little longer.

In general, the safe choice is **Save and Reboot**, but it is not necessary for every change you make in the Web UI.

4.5 Firmware Updates

4.5.1 New Firmware Releases

New firmware releases for the Link IO platform are announced through SKAARHOJ Discovery. When you open SKAARHOJ Discovery, it automatically checks for updates and notifies you if a new firmware version is available for your device. The application will then download the update and prompt you to install it when your device is connected via USB.

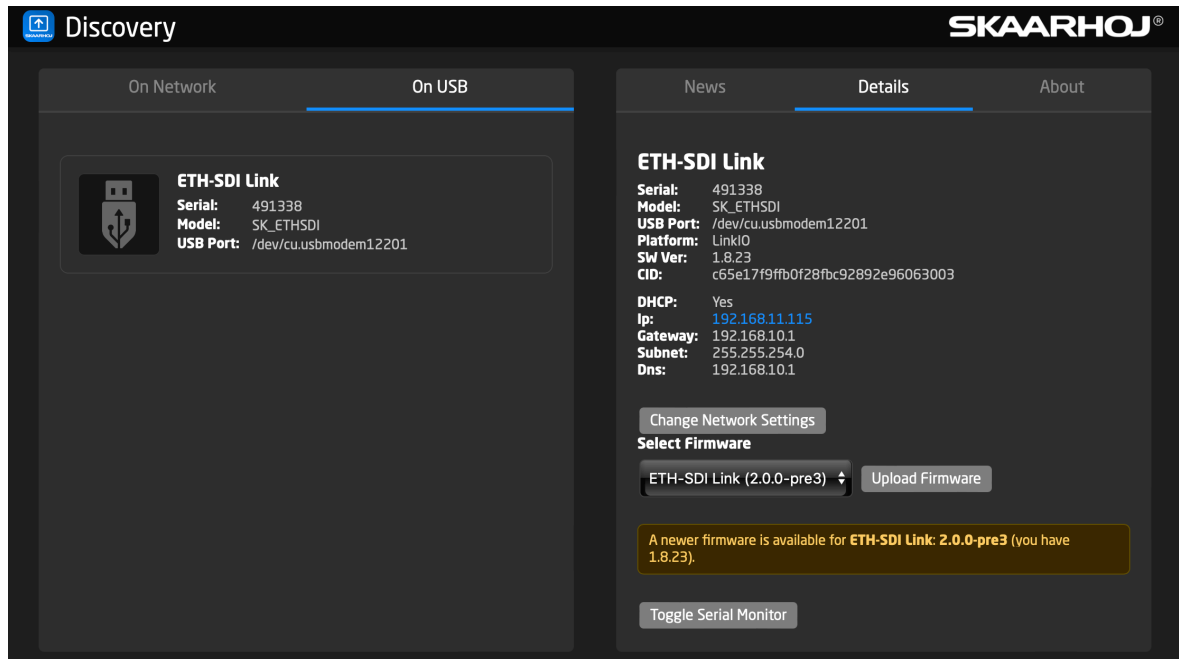

To install the update, simply click the Upload Firmware button. The new firmware will be transferred to your device.

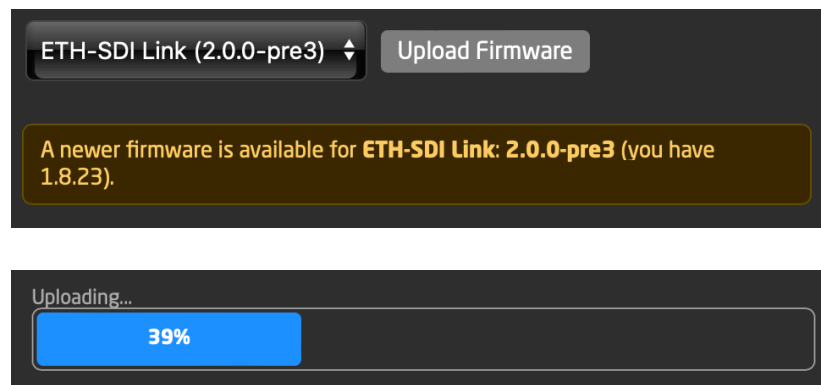

After the update process finishes, the device will reboot automatically. If it does not, you may need to power cycle it by unplugging and reconnecting the device.

Hint

Not Online all the time?

SKAARHOJ Discovery requires an internet connection to download firmware updates. You must therefore be online - at least temporarily - during the update process. For all other interactions with your device, whether over network or USB, an internet connection is not required.

If you see a green badge in the footer of the Web UI, it indicates that your computer running SKAARHOJ Discovery is online and connected to the SKAARHOJ servers.

Registered to: kasper@skaarhoj.com | Version: v1.0.0-pre5 | [Go Mobile](#) | [Expert](#) | [Online](#) | © 2025 SKAARHOJ ApS. All rights reserved.

4.5.2 Factory Reset

If you encounter issues with your device, a factory reset may be required. This restores the device to its original settings and erases all custom configurations. A factory reset can be performed in several ways:

- **From SKAARHOJ Discovery:** In the Details tab, click the Factory Reset button. It's shown if settings have become corrupted.
- **Using the Reset Button:** Hold down the Reset button on the device for 10 seconds. This resets all settings to defaults, including network configuration and any custom labels or parameters.
- **Via Serial Monitor:** Open the Serial Monitor in the Details tab of SKAARHOJ Discovery and type the command `_resetAll`. Be sure to close the Serial Monitor after performing the reset.

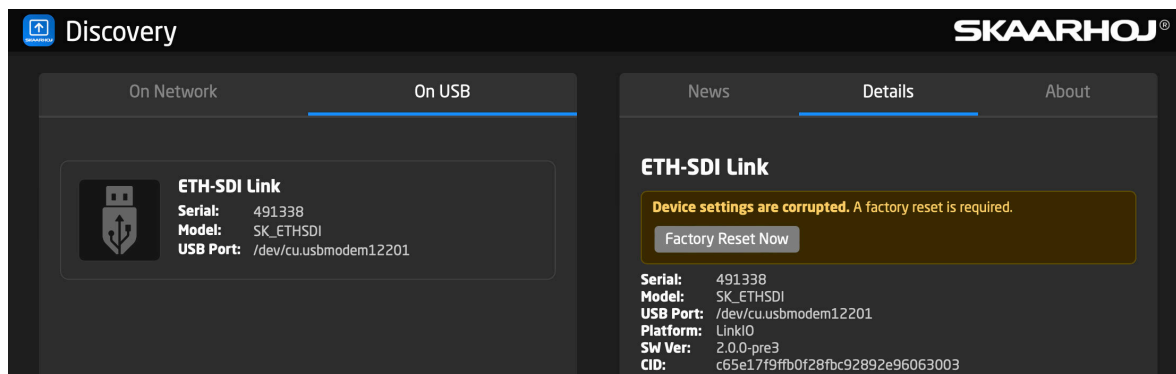

4.5.3 Wrong Firmware

If the wrong firmware has been uploaded to your Link IO device, this will be indicated in SKAARHOJ Discovery.

The screenshot shows the SKAARHOJ Discovery interface. The 'On USB' tab is selected, displaying a device card for 'Micro Fly' with the following details:

- Serial:** 491338
- Model:** SK_MICROFLY
- USB Port:** /dev/cu.usbmodem12201

The 'Details' tab is also visible, showing a warning message: **Firmware/device mismatch.** The running firmware doesn't match the registered model. Open the serial monitor and type `reset` for details. Below the warning, the following details are listed:

- Serial:** 491338
- Model:** SK_MICROFLY
- USB Port:** /dev/cu.usbmodem12201
- Platform:** LinkIO
- Sw Ver:** 3.0.0-pre2
- CID:** c65e17f9ffb0f28fbc92892e96063003

In this case, first enable Expert Mode by clicking the link in the footer. Otherwise you cannot select other firmware types than the one currently installed.

Registered to: kasper@skaarhoj.com | Version: v1.0.0-pre5 | [Go Mobile](#) | [Expert](#) | [Online](#) | © 2025 SKAARHOJ ApS. All rights reserved.

Next, open the Serial Monitor and type `reset`, then press Enter. The device will reboot and display a message indicating the device type it is really registered as. Read the text carefully, as it will tell you which firmware type to select in the next step.

The screenshot shows the Serial Monitor interface. At the top, there is a 'Toggle Serial Monitor' button. The main area displays the following text:

```
Resetting...

*****
SKAARHOJ Device Booting
*****
Compiled: Aug 16 2025 16:35:20
Software Version: 3.0.0-pre2
Model: SK_MICROFLY
CID: c65e17f9ffb0f28fbc92892e96063003
WRONG FIRMWARE LOADED ONTO THIS DEVICE!
Device is registered as: SK_ETHSDI with serial 491338
This firmware is for: SK_MICROFLY
```

At the bottom of the interface, there is a 'reset' button highlighted with a blue border.

From the list of available firmware in SKAARHOJ Discovery, select the correct firmware for your device and click the Upload Firmware button. The device will reboot and be ready for use with the correct firmware installed.

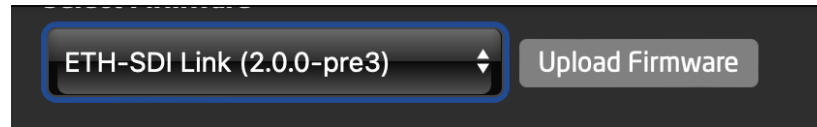

4.5.4 Upgrading to the Link IO Platform

If you wish to upgrade an eligible SKAARHOJ UniSketch or Link IO device to the Link IO platform, follow the steps below. The process requires registering the device on SKAARHOJ's servers, so you must be online during the upgrade. Registration is pending approval by SKAARHOJ and may be free of charge or require a fee, depending on the device and upgrade path.

When you first connect your device, it will appear as Unknown:

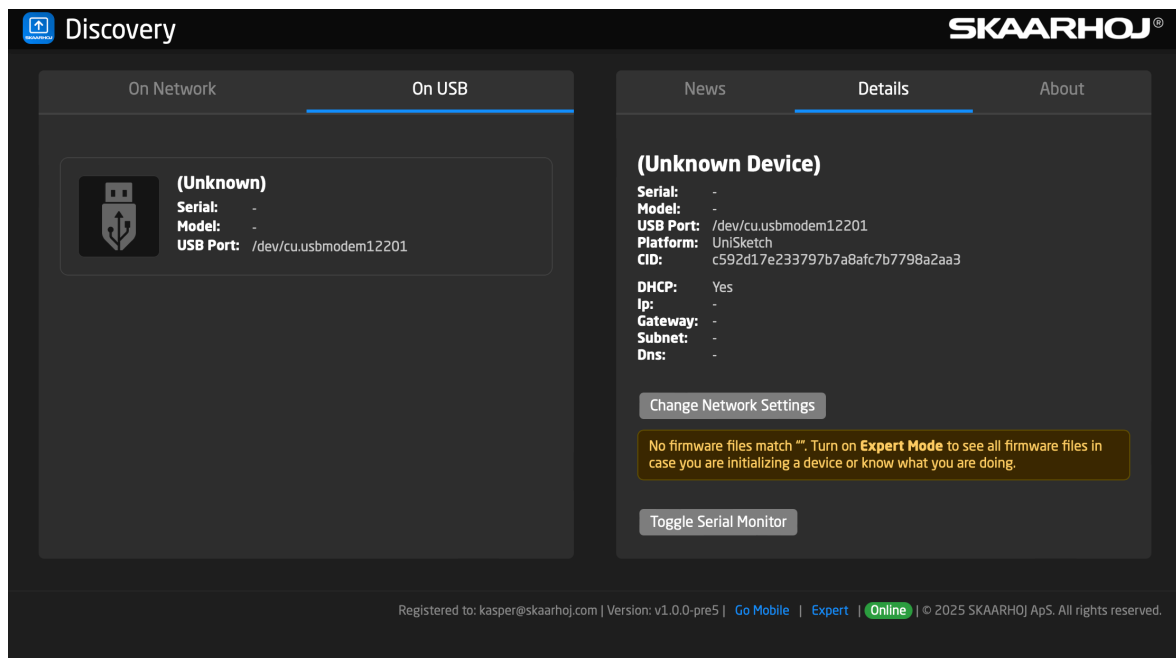

Enable Expert Mode by clicking the link in the footer. This will allow you to select any Link IO firmware type.

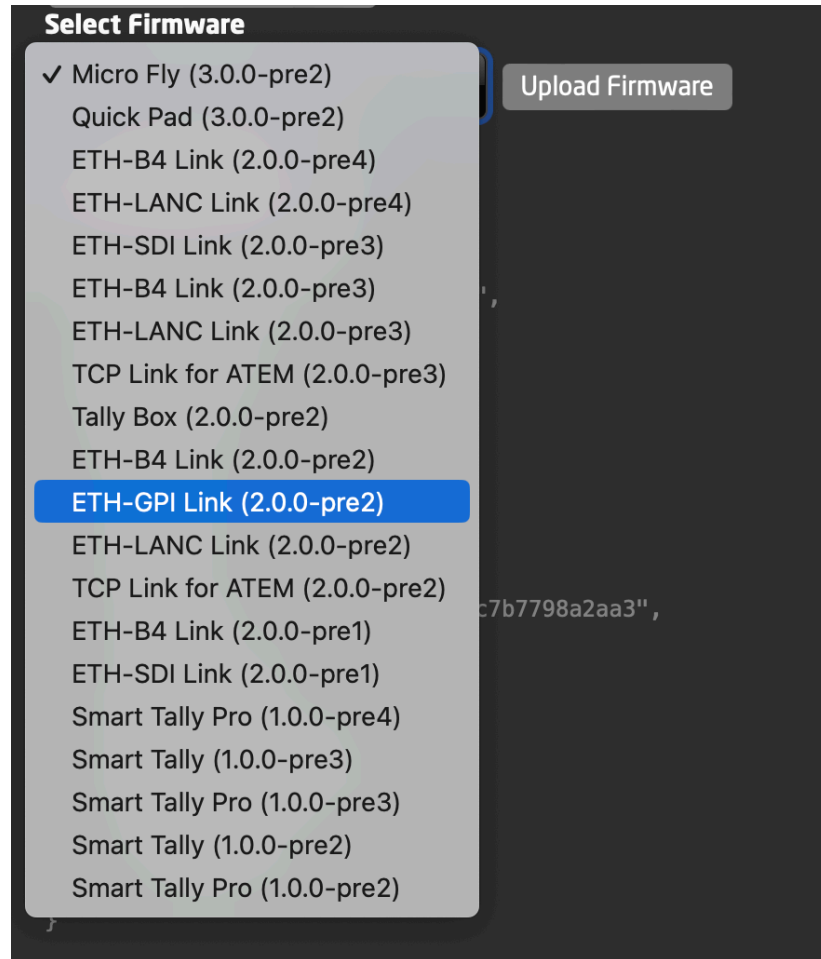

Carefully select the correct firmware type for your device. If you are unsure, contact SKAARHOJ Support for assistance. When you are ready, click the Upload Firmware button.

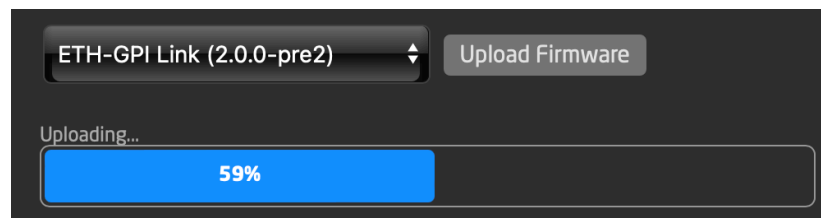

The device will reboot and display a message indicating that it is pending registration. Read the message carefully, and if you agree with its contents, enter the device's serial number and click the Register button.

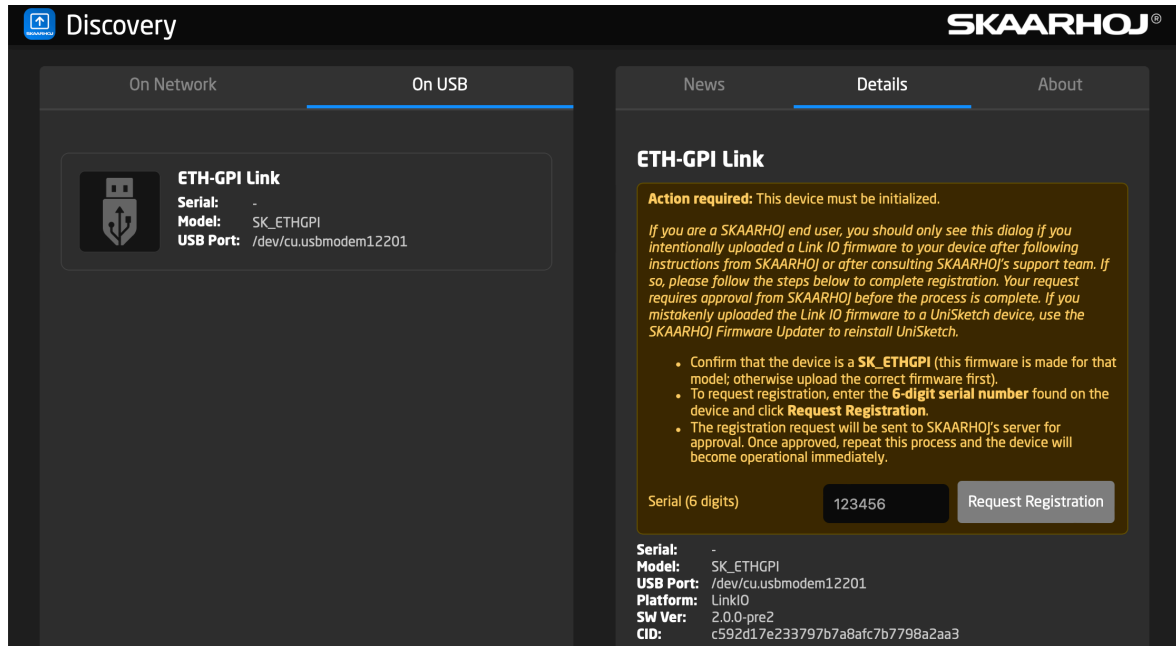

You will then see a confirmation that the device is pending registration. This step must be coordinated with SKAARHOJ Support, so please contact them to complete the approval process.

Registration pending: Registration request received and pending approval.

Once the device has been approved, return to the Web UI, enter the serial number again, and click the Register button. The device will then be fully registered and ready for use with the Link IO platform.

Registration approved: Registration approved.

The device will reboot and may appear as Unknown for a short time:

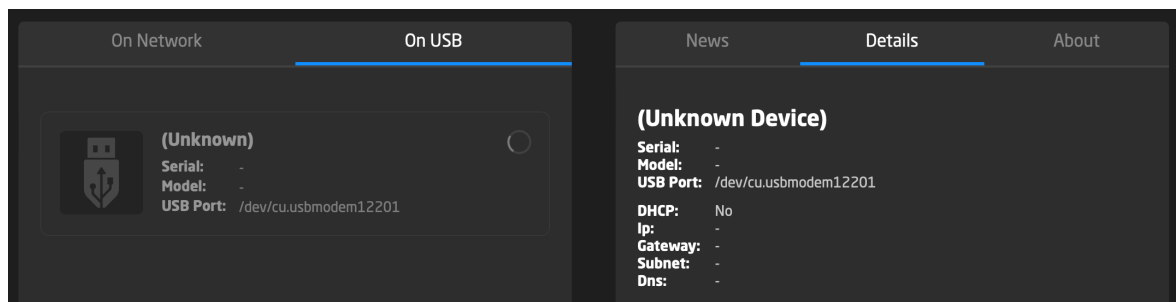

It will then update and show up as the correct device type:

The screenshot shows the SKAARHOJ Discovery application interface. The main window is titled "Discovery" and has a dark theme. It is divided into two main sections: "On Network" and "On USB". The "On USB" section is active, showing a list of discovered devices. One device, "ETH-GPI Link", is selected and its details are shown in a separate pane on the right.

Device Details (ETH-GPI Link):

- Serial: 442305
- Model: SK_ETHGPI
- USB Port: /dev/cu.usbmodem12201

Network Settings:

- DHCP: Yes
- Ip: 192.168.11.175
- Gateway: 192.168.10.1
- Subnet: 255.255.254.0
- Dns: 192.168.10.1

Below the network settings, there are several interactive buttons: "Change Network Settings", "Select Firmware", "ETH-GPI Link (2.0.0-pre2)" (with a dropdown arrow), "Upload Firmware", and "Toggle Serial Monitor".

At the bottom of the interface, a footer line reads: "Registered to: kasper@skaarhoj.com | Version: v1.0.0-pre5 | Go Mobile | Expert | Online | © 2025 SKAARHOJ ApS. All rights reserved."

Hint

Internet Connection Required

The upgrade and registration process requires an active internet connection:

- **Stay online during registration:** Your computer must connect to SKAARHOJ's servers to complete the registration and approval process.
- **Approval is handled remotely:** Registration will remain pending until SKAARHOJ Support approves the request.
- **Offline use afterwards:** Once the upgrade and registration are complete, the device can be used fully offline on your local network.

Make sure you are connected to the internet until the registration process has been successfully completed.

5 TCP Link for ATEM Functionality

The TCP Link for ATEM is a compact interface device from SKAARHOJ that enables simple TCP-based control of Blackmagic Design ATEM switchers. It provides a straightforward way to send commands to an ATEM from third-party systems, scripts, or custom software without needing complex SDKs or drivers.

It bridges the gap between simple TCP control systems and the more complex ATEM protocol, making it ideal for AV automation, custom integrations, or environments where scripting and third-party triggers are required.

Key Features:

- **TCP Control Interface:** Accepts plain TCP ASCII commands to control your ATEM switcher via port 8899.
- **HTTP Control Interface:** Accepts HTTP GET requests for switching and state queries.
- **USB/Serial Interface:** Accepts plain text commands over the USB serial console.
- **Plug-and-Play:** Simple configuration through the built-in web interface.
- **Compact and Reliable:** Industrial-grade hardware for 24/7 operation.
- **Power Options:** Supports Power-over-Ethernet (PoE) or 12V DC input.

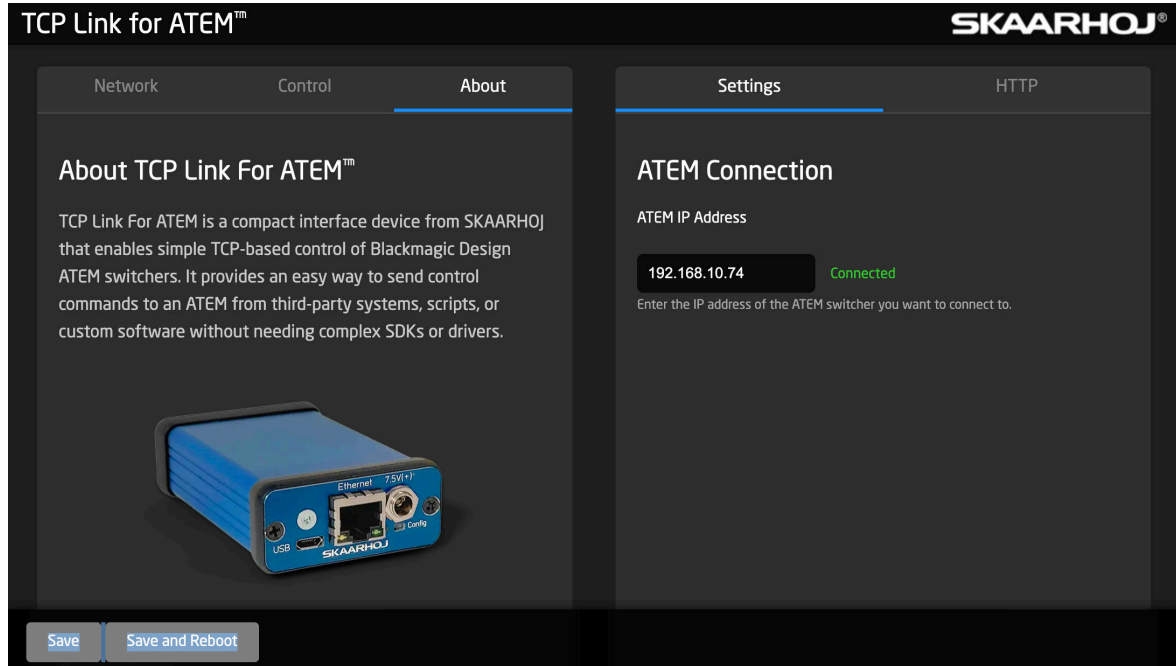

The screenshot displays the web interface for the TCP Link for ATEM device. The interface is dark-themed and features the SKAARHOJ logo in the top right corner. The main content is divided into two panels: 'About' and 'Settings'.

About TCP Link For ATEM™

TCP Link For ATEM is a compact interface device from SKAARHOJ that enables simple TCP-based control of Blackmagic Design ATEM switchers. It provides an easy way to send control commands to an ATEM from third-party systems, scripts, or custom software without needing complex SDKs or drivers.

Settings

ATEM Connection

ATEM IP Address

192.168.10.74 Connected

Enter the IP address of the ATEM switcher you want to connect to.

At the bottom of the interface, there are two buttons: 'Save' and 'Save and Reboot'.

Notice**Important Information**

Compatibility may vary depending on your ATEM switcher model and firmware version. Some ATEM switchers may expose too much state data for the device to handle reliably. If you experience connection or functionality issues, please contact SKAARHOJ support for assistance. In some cases, an alternative product such as TCP Link for ATEM Pro may be recommended.

5.1 Settings Tab

The **Settings** tab is where you configure the connection to your ATEM switcher.

- **ATEM IP Address:** Enter the IP address of the ATEM switcher.
- **Connection Status:** The field will show *Connected* in green text if communication is successful. If not, it will show *Disconnected*.

The device runs a TCP server on port 8899. You can connect to it and issue ASCII commands directly. Here are some example commands:

- `performCutME:0=1` –Cuts on M/E bus 1.
- `AuxSourceInput:0=4` –Sets input 4 on Aux bus 1.

Any interaction on the ATEM switcher is also echoed back over the TCP connection, which makes it easy to learn command syntax and re-use commands.

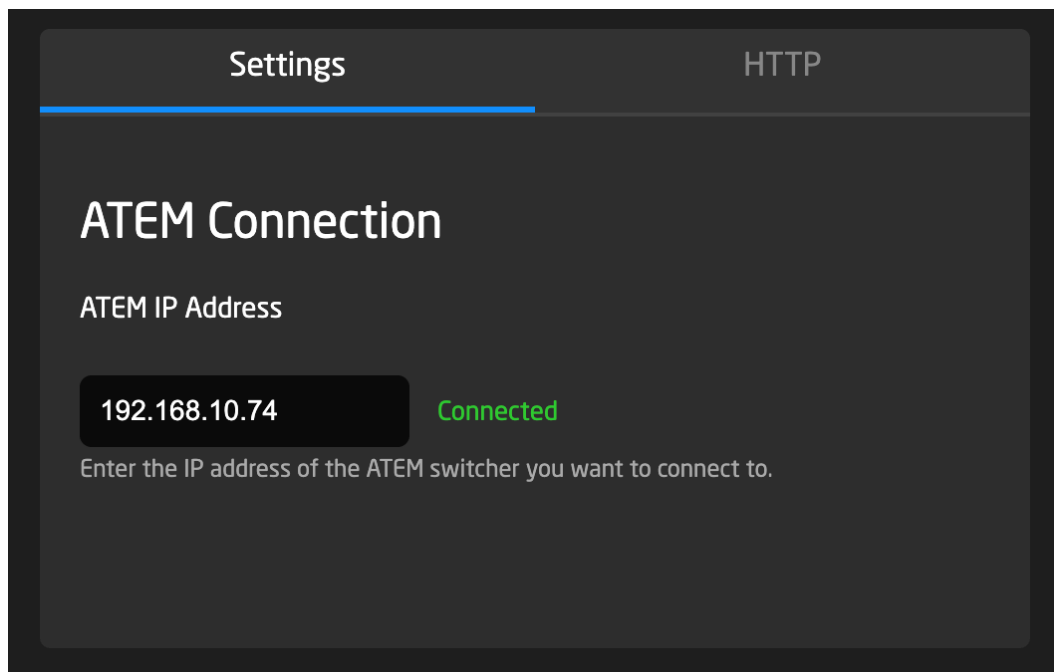

Notice

Command Availability

Not all ATEM commands are supported. For a full list of supported commands and limitations, refer to the official documentation linked in the Settings tab, or contact SKAARHOJ support.

5.2 TSL Tab

The **TSL** tab enables TCP Link for ATEM to output tally messages over the industry-standard TSL protocol (versions 3.1 and 5.0) via UDP. This allows integration with external multiviewers, tally bridges, and custom tally lamps that expect TSL data.

- **Enable TSL:** Toggle to activate TSL output.
- **Destinations:** Configure up to five UDP IP:PORT pairs. Packets will be sent to all active destinations whenever a tally state changes.
- **Periodic Refresh:** Optionally enable "Send out all TSL tallies every 15 seconds" to re-prime receivers that may time out or lose state.

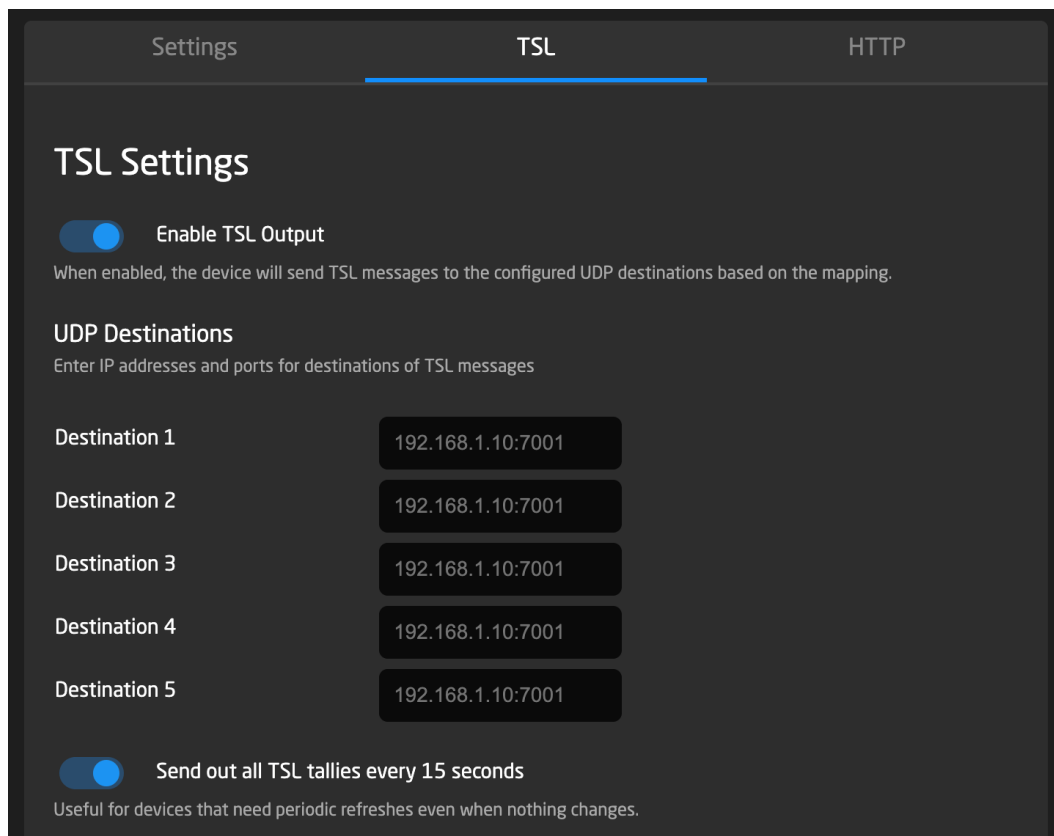

Mapping Inputs to TSL Each ATEM Input can be mapped individually to TSL addresses using either TSL 3.1 or TSL 5.0:

- **TSL 3.1:** Configure the Address (0-126) and the Red/Green bits (0-3) that correspond to each lamp.
- **TSL 5.0:** Configure the Screen and Index, and select the Pos (Left / Text / Right / Any) which determines which tally field drives the lamp.

Tally Mapping

Prefill with TSL 3.1
Prefill with TSL 5

ATEM Input	Mode	Config		
Input 1 ● ●	TSL 3.1 ▼	Addr <input style="width: 40px;" type="text" value="1"/>	Red Bit <input style="width: 40px;" type="text" value="1"/>	Green Bit <input style="width: 40px;" type="text" value="2"/>
Input 2 ● ●	TSL 3.1 ▼	Addr <input style="width: 40px;" type="text" value="2"/>	Red Bit <input style="width: 40px;" type="text" value="1"/>	Green Bit <input style="width: 40px;" type="text" value="2"/>
Input 3 ● ●	TSL 5.0 ▼	Screen <input style="width: 60px;" type="text" value="123"/>	Index <input style="width: 60px;" type="text" value="902"/>	Pos Any ▼
Input 4 ● ●	TSL 5.0 ▼	Screen <input style="width: 60px;" type="text" value="123"/>	Index <input style="width: 60px;" type="text" value="901"/>	Pos Any ▼
Input 5 ● ●	Off ▼			
Input 6 ● ●	Off ▼			

Use Cases

- Forwarding ATEM tallies to external devices such as tally lamps or software systems.
- Providing tally data to graphics engines or automation systems that listen for TSL.
- Ensuring stable operation in environments where receivers require periodic refreshes.

Notice

TSL Protocol Notes

Not all receivers support both TSL 3.1 and 5.0. Check your downstream equipment's documentation to choose the correct mode. If unsure, start with TSL 3.1 as it is most widely supported.

5.3 HTTP Tab

The **HTTP** tab allows you to enable a lightweight HTTP API. This API mirrors the TCP command interface and is required for the **Control Tab** in the web UI to function.

- **Enable HTTP API:** Toggle to activate HTTP interface.
- **Base URL Format:**

```
http://<device_ip>/atem/<command>
```

Example Commands:

- `/atem/ProgramInputVideoSource:0=3` –Sets Program input on ME 1 to source 3.
- `/atem/PreviewInputVideoSource:0=4` –Sets Preview input on ME 1 to source 4.
- `/atem/performCutME:0` –Performs a Cut transition on ME 1.
- `/atem/performAutoME:0` –Performs an Auto transition on ME 1.
- `/atem/dumpState` –Returns the full current ATEM state (slow response, large data).

Responses: All valid requests return plain text responses echoing the command or current state.

Caution

Authentication for Automation

Credentials can be embedded in URLs for automation: `http://admin:<password>@<device_ip>/atem/...`
This method is insecure on shared networks —use only in trusted environments.

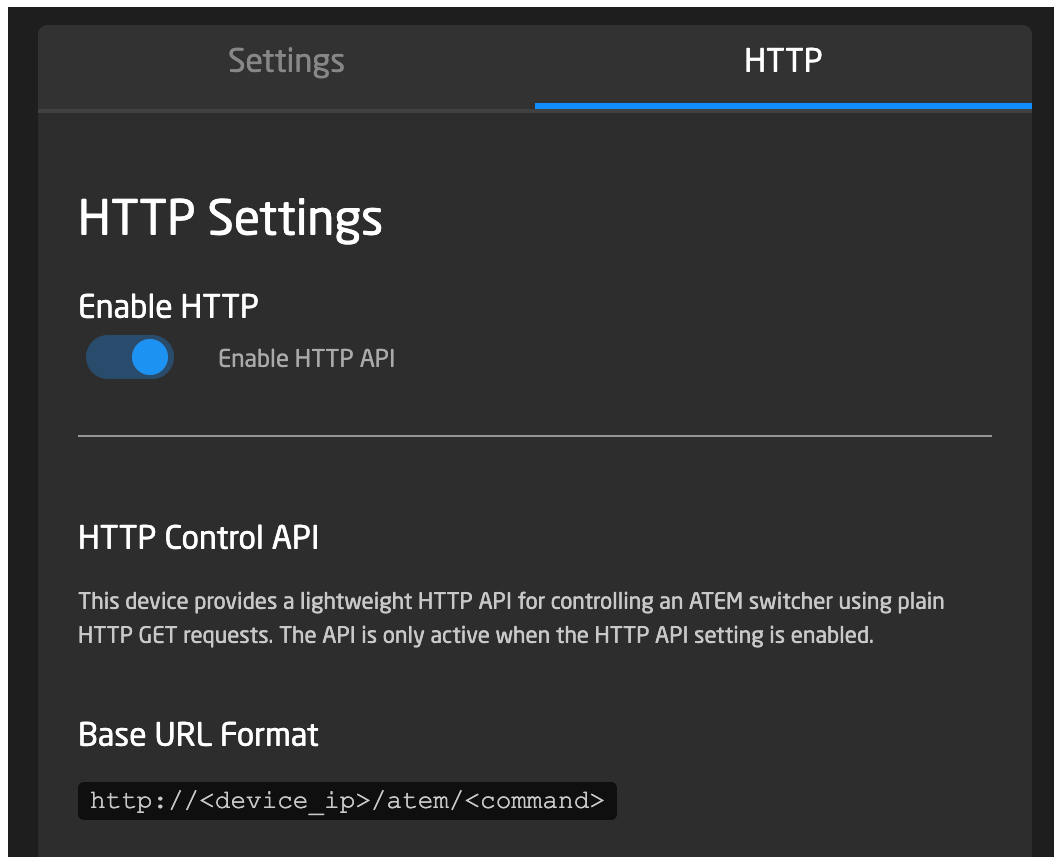

5.4 Control Tab

The **Control** tab provides a simple UI switcher for testing the ATEM connection.

- **Program Bus:** Four buttons to set Program source (1–4). Active source shows in red.
- **Preview Bus:** Four buttons to set Preview source (1–4). Active source shows in green.
- **Cut / Auto:** Buttons to perform a Cut or Auto transition.

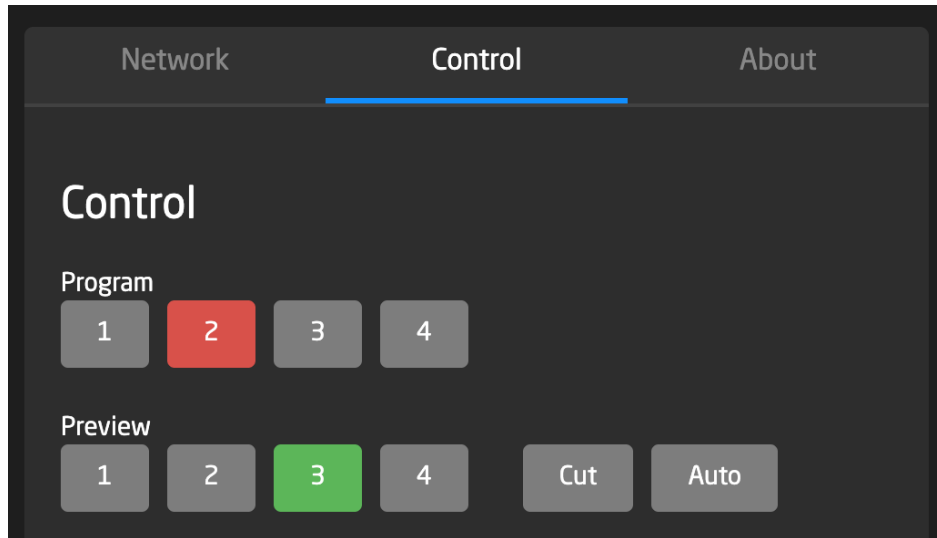

Notice

Note on Usage

The Control tab is intended primarily for testing connectivity to the ATEM switcher. While you may use it for basic switching, it is not designed to replace a production switcher interface.

6 Service

6.1 Troubleshooting

For troubleshooting tips, please refer to our online Wiki:

<https://wiki.skaarhoj.com/books/blue-pill-reactor/chapter/troubleshooting>

6.2 Cleaning

Proper cleaning and maintenance of your TCP Link for ATEM are critical to ensuring its durability and optimal performance. Regular cleaning, when done with care and the right materials, will help maintain the device in excellent working condition. On the other hand, improper cleaning techniques or the use of harsh chemicals can lead to permanent damage to surfaces, connectors, and labels. To prevent wear and tear, it is important to adhere to the cleaning recommendations outlined in this section.

Notice

Proper Cleaning of TCP Link for ATEM

To avoid surface damage, follow these guidelines:

- **Disconnect all accessories and cables** before cleaning.
- **Only use the recommended cleaning agents** listed in this section.
- **Avoid harsh chemicals** like Methanol, Acetone, Benzene, or acids. These substances may damage labels, paint, and polished surfaces.
- **Keep connectors dry** —do not moisten connectors or expose them to cleaning liquids.
- **Avoid touching connector pins** directly while cleaning.
- **Air-blow dust from connectors** before wiping them. Use deionized air if static charge is present.
- **Do not use compressed air** on the housing, as it can push dust into the device.

Recommended Cleaning Agents:

- Water
- Glass Cleaner
- Isopropyl Alcohol

To maintain the longevity and optimal performance of your TCP Link for ATEM, it is essential to follow proper cleaning guidelines. Different areas of the device require specific cleaning methods to avoid

damage to sensitive components. The following table outlines the recommended cleaning procedures for key areas of the device.

Area	Recommended Cleaning Procedure
Housing	Wipe the housing and external accessories with a soft, lint-free cloth and a mild cleaner like water or glass cleaner. When necessary, use isopropyl alcohol to remove tough residues, such as adhesive or dirt buildup.
Narrow spaces and gaps	Use a manual air blower or a soft brush to gently remove dust from gaps and tight spaces. For delicate areas, cotton swabs may also be used.

Table 2: Proper cleaning methods for TCP Link for ATEM

By following these cleaning instructions, you can avoid damaging your device and its components. Routine maintenance will keep your TCP Link for ATEM in top condition and reduce the likelihood of damage that could lead to costly repairs or replacements.

6.3 Repair

In addition to proper cleaning, it is also important to be cautious when it comes to repairs. Performing repairs without the necessary expertise can result in personal injury and may further damage the device.

Warning

Repairs by Untrained Personnel

Attempting to repair the device without proper training can lead to injury and product damage:

- **Only perform maintenance tasks** described in this manual.
- **Do not attempt repairs yourself** —all repairs must be carried out by authorized SKAARHOJ service partners.
- **Warranty is void** if unauthorized repairs are attempted.

Repairs and maintenance should always be conducted by professionals trained to handle the TCP Link for ATEM. If you encounter any issues requiring repair, we highly recommend contacting SKAARHOJ's authorized service partners. Unauthorized repairs may void the warranty, cause further damage, and pose significant safety risks.

To keep your TCP Link for ATEM functioning optimally, always refer to this manual for proper cleaning and repair procedures. For any work beyond the scope of this manual, please contact SKAARHOJ Support team for assistance.

6.4 Disposal

Notice

Disposal of the Product

You can return the product at your own expense to the manufacturer, SKAARHOJ ApS, for disposal. Always follow local guidelines and laws for proper disposal.

Proper disposal of electronic equipment is essential to reduce environmental impact and ensure that hazardous materials are handled safely. Different countries may have specific laws and guidelines regarding electronic waste disposal. It is important to familiarize yourself with these rules to ensure compliance and minimize risks to both health and the environment.

When disposing of third-party accessories, always consult the instructions provided by the relevant manufacturers to ensure safe and compliant disposal practices.

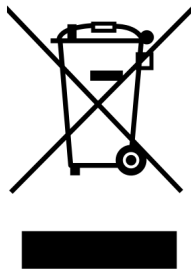

This product falls within the scope of Directive 2012/19 / EU OF THE EUROPEAN PARLIAMENT AND OF THE COUNCIL of June 4, 2012 on waste electrical and electronic equipment (WEEE II).

Accordingly, this product must not be disposed of with household waste. Always adhere to country-specific disposal rules and ensure proper recycling or disposal through authorized facilities.

In addition to the general guidelines provided above, the product must always be disposed of in accordance with local electronic waste regulations. The WEEE Directive sets the framework for the handling of waste electrical and electronic equipment across EU member states. It ensures that electronics are collected and treated separately from household waste to minimize environmental harm.

6.5 Transportation and Storage

Notice

Proper Handling of TCP Link for ATEM

To avoid the risk of product damage:

- Follow the recommended environmental conditions at all times.
- Use an appropriate case for transporting the product and its accessories.
- Adhere to the transport and storage guidelines outlined in this section.

Ensuring proper transportation and storage of your TCP Link for ATEM is critical to maintaining its performance and longevity. Mishandling the device or its accessories can lead to damage. Please follow these guidelines to protect your equipment during transportation and storage.

Transportation Guidelines:

- Detach all accessories from the product before transport.
- Always transport the product in a protective case designed for its dimensions.
- Avoid exposing the product to strong shocks or impacts during transport.
- Keep the product within the recommended temperature range.

Storage Guidelines:

- Remove all accessories before storing.
- Disconnect all cables and power sources from the product.
- Store the product in a protective case.
- Keep the product within the recommended temperature range.
- Avoid storing the product in environments exposed to extreme temperatures, direct sunlight, high humidity, excessive vibration, dust, or strong magnetic fields.

6.6 SKAARHOJ Service Contacts

For any inquiries, technical support, or service requests regarding your TCP Link for ATEM, please reach out to our support team. Our dedicated professionals are ready to assist you with troubleshooting, repairs, and general product information. You can find the contact details for SKAARHOJ below.

SKAARHOJ ApS

Rosenkaeret 11C
DK-2860 Soeborg
Denmark
Email: support@skaarhoj.com
Website: www.skaarhoj.com

SKAARHOJ Inc

2600 W Olive Avenue Suite 500
Burbank, CA 91505
USA
Email: support@skaarhoj.com
Website: www.skaarhoj.com

7 Notes
