

Panasonic

Closed Circuit Video Equipment

Matrix System150

M A T R I X

S Y S T E M

1

5

0



Matrix Switcher
WJ-SX150A
Matrix Switcher with Multiplexer Function
WJ-SX155



System Controller
WV-CU360CJ

Controls up to 64 cameras and 4 monitors. The Matrix System150 is compact, high in quality and cost effective.

The new Panasonic Matrix System150 is ideal for small-scale surveillance applications. The Matrix Switcher can link up to 64 cameras, 4 monitors and 4 controllers. It can be combined with our dome cameras providing excellent image quality.

All of the Matrix System150's 64 channels employ Panasonic proprietary coaxial, multiplex connectors. Video signals, control data, synchronous signals (VD2) and alarm signals all travel over a single cable, reducing the number of lines required for camera installation. Cables can be as long as 1,200m. This System also supports remote camera control using RS-485 data.

The Matrix System150 is loaded with special features including tour sequencing, alarms, video loss detection, and character displays on the monitor. All features are easy to operate using the WV-CU360CJ dedicated system controller.

One major feature is the ease of changing system settings using menus displayed on a personal computer. Providing direct control of all device settings as well as user management features, the system administration software bundled with the Matrix System150 imposes no extra burden on system administrators. Access to vital settings data can be restricted to a specified level of user through use of passwords.

The Matrix System150 is ideal for schools, supermarkets, banks, parking lots, warehouses, and correctional facilities. The Matrix System150's small-scale system simplifies operation while providing all the features required for high-level surveillance.



Major Features and Functions

Camera

- Supports up to 64 cameras.
- All 64 channels are coaxial, multiplex cables, reducing the number of cables required and simplifying installation.
- Supports up to 64 RS-485, remote-controlled cameras.
- Pan, tilt and other cameras lens motions can be controlled either by coaxial, multiplex cable or RS-485 remote-control signals.
- Cables can be up to 1,200m long.
- The video loss detection function automatically detects camera malfunctions.

System

- All sequence and alarm modes can be adjusted as needed.
- User management features include operator number, password, level, and priority.
- Personal computer screen displays simplify set-up and management of alarm histories.
- Supports up to 80 alarm inputs and four alarm outputs.

Monitor

- Output supports up to 4 monitors.
- Character displays show date, time, camera number, camera title, and event information.
- Alarm history display shows up to 100 most recent alarms.

External Links

- The RS-485 camera ports allow remote surveillance.
- The RS232C ports enable connection to personal computers or VTRs.

MATRIX SYSTEM150

Sequencing and Alarm. Just Two of Many Features that Support Effective Surveillance.



Sequencing Increases Monitoring Efficiency

Pre-set the sequence in which to view an image from a series of different cameras. The WV-CU360CJ System Controller makes it possible to choose from a variety of sequence patterns with push-button ease. Just select the one that provides the most effective coverage.

Tour Sequence

The monitor switches automatically, following a pre-set sequence from channel 1 to channel 64. Each sequence can include up to 64 steps, with each step set for from one to 30 seconds in length. In addition, dome cameras can also be pre-set to precisely the viewing angle you need. Up to 32 touring patterns can be stored in memory for easy recall.

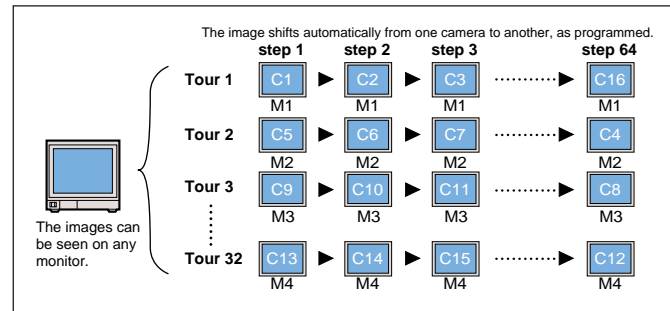

Group tour (Simultaneous tour sequencing)

This feature allows you to activate multiple, pre-set tour sequences by pushing a single button. Each group can include up to four separate sequences. Up to four group-tour sequences can be stored in memory.

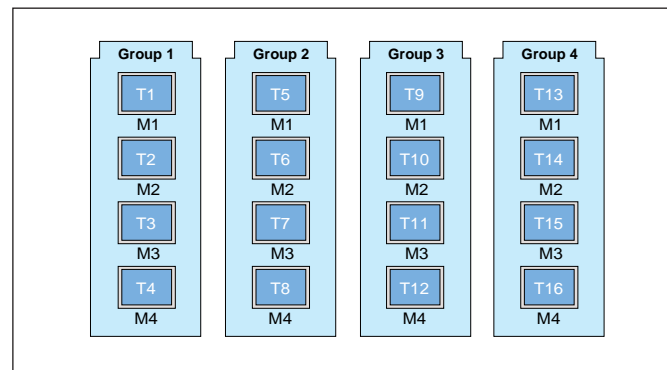

64 Channels are All Transmitted via the Same Coaxial Cable

Video signals, control data, synchronous signals (VD2), and alarm signals are all transmitted over the same coaxial, multiplex cable. Use of the same cable reduces both time and trouble required for camera installation. Each coaxial cable can be up to 1,200m long.

1. Video signal

Transmits the image captured by the camera to the Matrix Switcher.

2. Control data

Transmits settings from the Matrix Switcher to the camera. Allows control of pan, tilt and zoom features of WV-CS850A/CW860 Series intelligent dome cameras and, via WV-RC100/RC150/RC170 remote control receivers, an external PTZ, WV-CP470/WV-CP240.

3. Synchronous signals (VD2)

Supports almost all Panasonic CCD cameras (see compatible camera list). Allows simultaneous image switching by cameras and the Matrix Switcher, preventing image distortion.

4. Alarm signals

Transmits alarm signals received from the camera to the Matrix Switcher, initiating the pre-set alarm event sequence.

Compatible Panasonic camera list

B/W Cameras	WV-BP140 Series, WV-BP330 Series
Colour Cameras	WV-CP470 Series, WV-CP240 Series, WV-CL920A Series, WV-CW474F
Integrated Dome Cameras	WV-CS850A Series, WV-CS320 Series, WV-CW860 Series

Since 1988, most of Panasonic cameras have been designed and manufactured to accept VD2 signal for system integration.

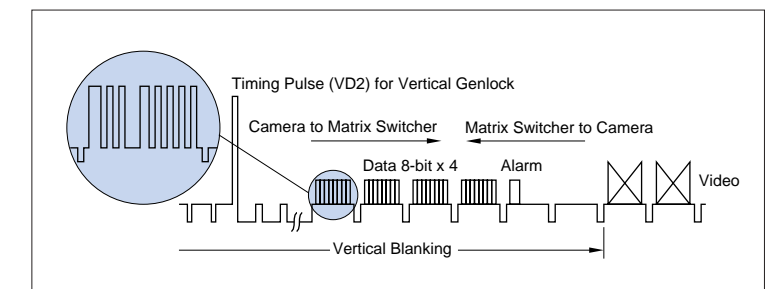

Instant No-Escape Alarms

Sequence mode (In response to spot alarm)

When the alarm signal is received, the monitor and camera instantly switch to the spot from which it originates. When two or more alarms are received, the system switches instantly to the spot from which the latest alarm originates. Pressing the ACK key switches operator control to the camera from which the alarm was received.

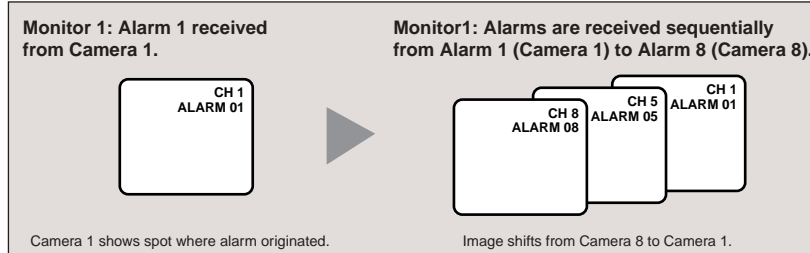

Hold mode (In response to spot alarm)

When the alarm signal is received, the monitor shows the image from the pre-set camera. When two or more alarms are received, the monitor continues to show the image of the spot from which the first alarm was received. Pressing the ACK key switches operator control to the camera from which the alarm was received.



Concerning start of sequence alarm

The system can also be pre-set to start a tour sequence when an alarm signal is received. However, once a sequence begins, a second alarm cannot enter the monitor, as it can in sequence or hold mode.

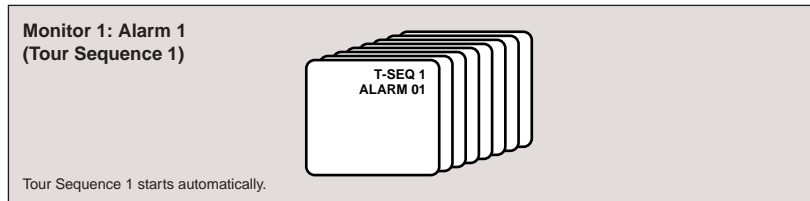

User Management Protects Against Misuse

This system manages user names and other user information for up to 16 users, who may use the controller itself or log in from a personal computer. Matrix System150 operation can be limited by use of five user attributes including operator number, password, label, priority, and the cameras the user is permitted to operate. This user management feature prevents improper use by outsiders or unauthorized persons.

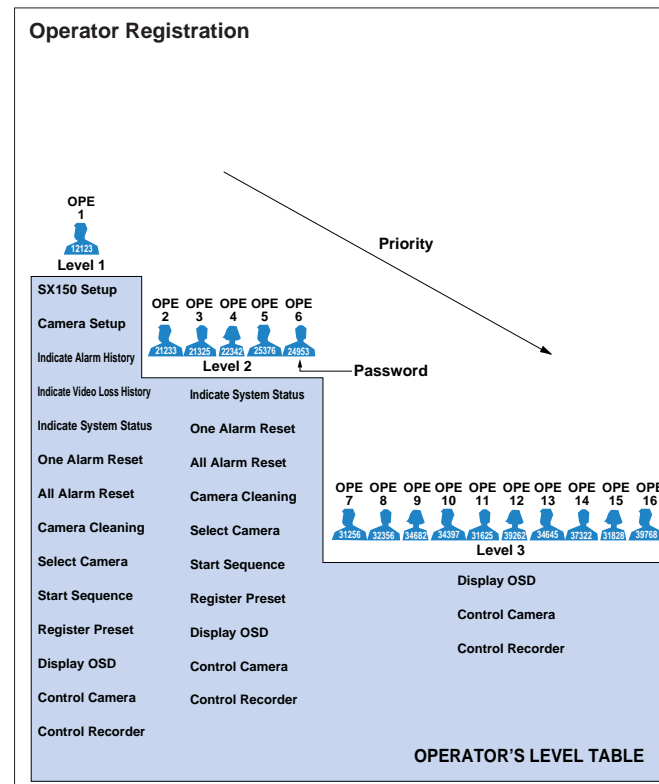

Other Convenient Features

RS-485 Port

Up to 64 cameras can be controlled through the built-in RS-485 ports.

RS232C External Serial Interface

The RS232C port permits system set-up and alarm history management from a personal computer. It also supports time-lapse VTR and other peripherals.

Video Loss Detection automatically senses camera malfunction

This feature automatically senses loss of video signal input and displays a warning on the monitor, allowing speedy response to such problems as power outage, severed camera cables or damaged cameras.

Video Loss History Table

NO	DATE	CH	EVENT
012	2001/08/21 18:59:08	03	VIDEO RECOVER
011	2001/08/21 18:58:08	14	VIDEO RECOVER
010	2001/08/21 18:57:08	09	VIDEO LOSS
009	2001/08/21 18:55:08	07	VIDEO LOSS
008	2001/08/21 18:54:08	--	SW RECOVER
007	2001/08/21 18:53:08	16	VIDEO LOSS
006	2001/08/21 18:53:00	09	VIDEO LOSS
005	2001/08/21 18:52:08	--	SW RECOVER
004	2001/08/21 18:51:08	06	VIDEO LOSS
003	2001/08/21 18:50:08	01	VIDEO RECOVER

Monitor Character Displays

Four types of information are displayed on the monitor using the built-in character generator IC.

1. Date and time

Choice of five date styles and 24-hour or 12-hour time displays.

2. Camera title

A label up to 20 characters long can be added to the camera number.

3. Monitor status

Shows monitor number, keyboard number, and sequence status.

4. Event information

Shows time and other information concerning alarm or timed events.

Example of Character Displays

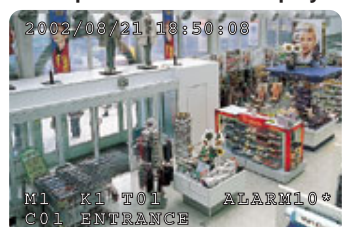

The above photograph was taken for the purpose of this explanation; actual images may differ.

Most recent 100 alarms display

The monitor display shows up to 100 of the most recent alarms in chronological order, allowing quick confirmation of alarm location, date, and time. Images can be recalled and reviewed with push button ease using the WV-CU360CJ system controller.

NO	DATE	ALARM	EVENT
016	2001/08/21 18:59:08	03	ALARM
015	2001/08/21 18:58:08	03	ACK
014	2001/08/21 18:57:08	03	RESET
013	2001/08/21 18:55:08	07	ALARM
012	2001/08/21 18:54:08	07	ACK
011	2001/08/21 18:53:08	07	RESET
010	2001/08/21 18:53:00	09	ALARM
009	2001/08/21 18:52:08	09	ACK
008	2001/08/21 18:51:08	06	ALARM
007	2001/08/21 18:50:08	06	ACK

Alarm history management using a personal computer

The alarm log can be output to a personal computer using the RS232C serial port, allowing use of the personal computer to manage alarm histories.

System Configuration is Simple and Trouble-Free.

Simple System Setup from PC System Configuration Software is Included.

Main Menu



The main menu is the heart of System150 Setup Utility.

Logical Camera Number

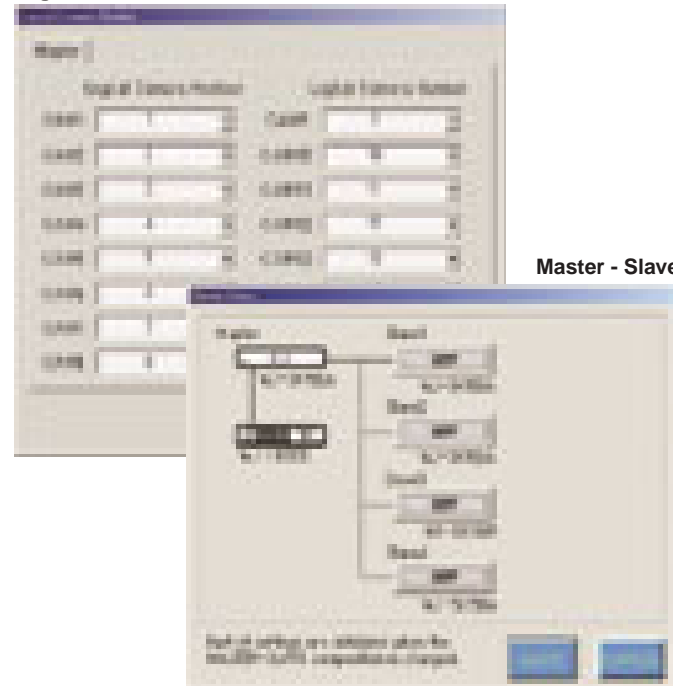

Master - Slave

Tour Sequence

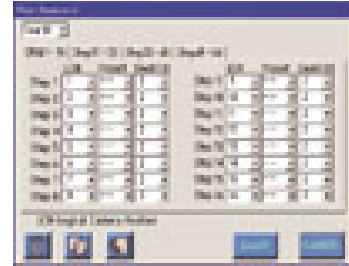

This window is used to edit a tour sequence. There are 16 tour sequences available, each with up to 16 steps. Each step needs a camera number associated pan/tilt preset position and a dwell time.

Group Sequence



This window is used to edit a group sequence. There are 4 group sequences available, each with up to 4 monitors.

Timer Event

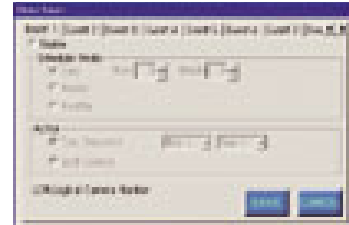

This window can be used to edit the time and type of the action.

Alarm Event

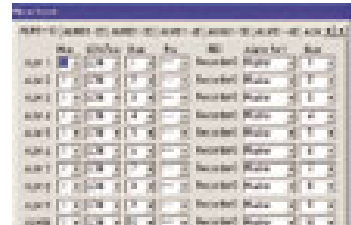

This menu can be used to program which monitor to carry out the spot/tour sequence of which camera, when an alarm signal is input.

Operator Registration

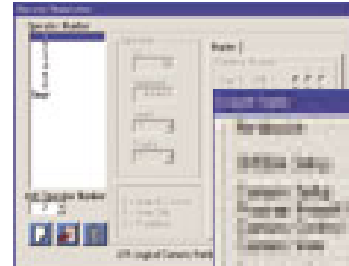

This window is used to assign the camera control to the operators, according to their priorities.

Level Window



This window is used to restrict the operators' control of functions according to their levels.

Flexible and Compatible with a Wide Range of Equipment

By combining our WJ-HD500B digital disk recorder with the Matrix System150, you will have a truly cost-effective system package. Adding the high-capacity WJ-HD500B digital disk recorder to the Matrix System150 makes possible the storage and retrieval of long-duration images. The Direct Search Feature allows immediate retrieval of images captured during a certain time of day from a complete list of stored images. Thumbnail Search Feature* makes it easy to identify and retrieve precisely the images needed.



WJ-HD500B Ensures High-quality, Moire-free Images

*Requires use of WV-CU50 Remote Controller

Thumbnail Searches

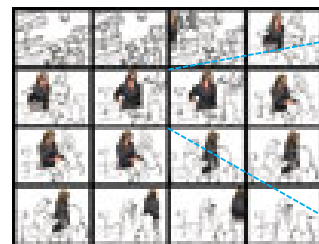

The frame you select expands to fill the whole display. With 2x electronic zoom, you can take a closer look at details.



The above photographs were taken for the purpose of this explanation; actual images may differ.

MAJOR OPERATING CONTROLS

Matrix Switcher; WJ-SX150A

Matrix Switcher with Multiplexer Function; WJ-SX155

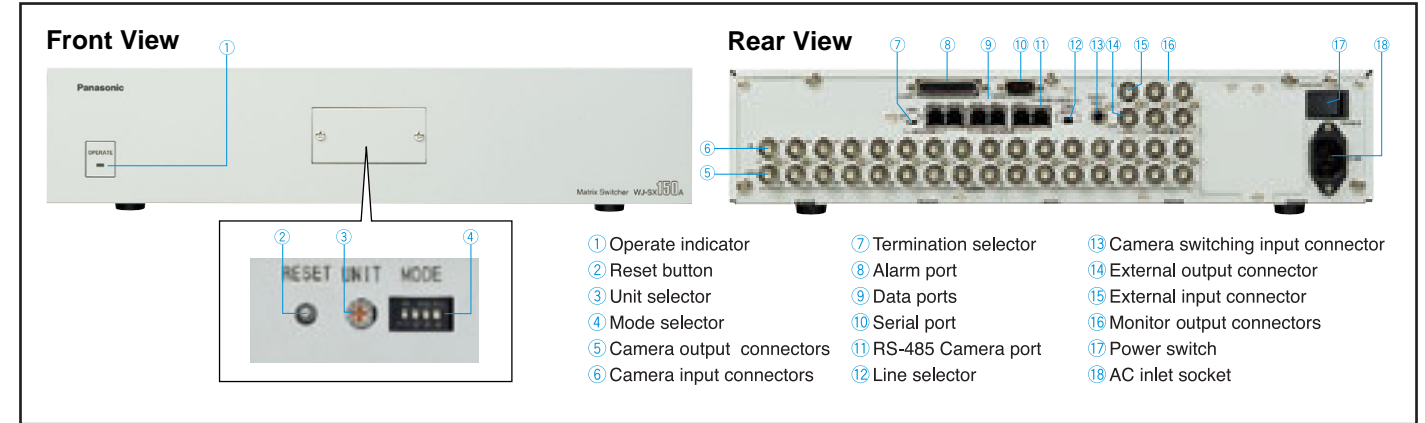

- ① Operate indicator
- ② Reset button
- ③ Unit selector
- ④ Mode selector
- ⑤ Camera output connectors
- ⑥ Camera input connectors
- ⑦ Termination selector
- ⑧ Alarm port
- ⑨ Data ports
- ⑩ Serial port
- ⑪ RS-485 Camera port
- ⑫ Line selector
- ⑬ Camera switching input connector
- ⑭ External output connector
- ⑮ External input connector
- ⑯ Monitor output connectors
- ⑰ Power switch
- ⑱ AC inlet socket

System Controller; WV-CU360CJ

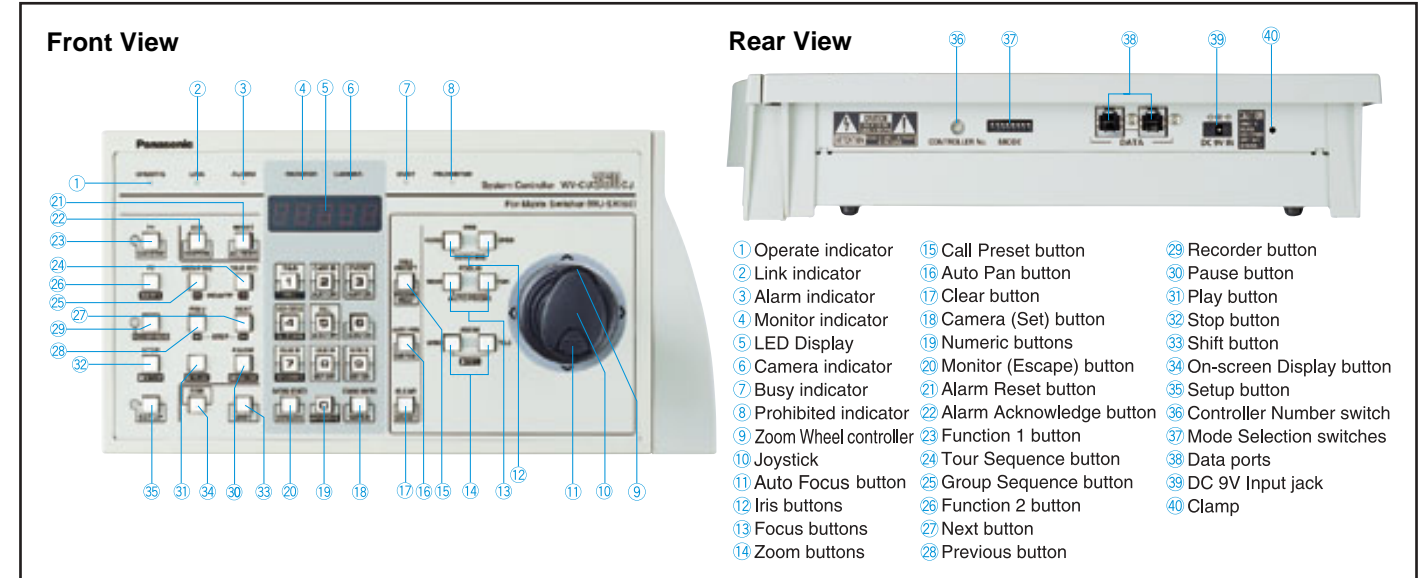

- ① Operate indicator
- ② Link indicator
- ③ Alarm indicator
- ④ Monitor indicator
- ⑤ LED Display
- ⑥ Camera indicator
- ⑦ Busy indicator
- ⑧ Prohibited indicator
- ⑨ Zoom Wheel controller
- ⑩ Joystick
- ⑪ Auto Focus button
- ⑫ Iris buttons
- ⑬ Focus buttons
- ⑭ Zoom buttons
- ⑮ Call Preset button
- ⑯ Auto Pan button
- ⑰ Clear button
- ⑱ Camera (Set) button
- ⑲ Numeric buttons
- ⑳ Monitor (Escape) button
- ㉑ Alarm Reset button
- ㉒ Alarm Acknowledge button
- ㉓ Function 1 button
- ㉔ Tour Sequence button
- ㉕ Group Sequence button
- ㉖ Function 2 button
- ㉗ Next button
- ㉘ Previous button
- ㉙ Recorder button
- ㉚ Pause button
- ㉛ Play button
- ㉜ Stop button
- ㉝ Shift button
- ㉞ On-screen Display button
- ㉟ Setup button
- ㊱ Controller Number switch
- ㊲ Mode Selection switches
- ㊳ Data ports
- ㊴ DC 9V Input jack
- ㊵ Clamp

SPECIFICATIONS PAL

Matrix Switcher; WJ-SX150A
Matrix Switcher with Multiplexer Function; WJ-SX155

Model No.	WJ-SX150A	WJ-SX155
Power Source	220V - 240V AC, 50Hz	
Camera Input (1 - 16)	1.0 V[p-p]/75 Ω composite video signal 0.5 V[p-p]/75 Ω data signal and 2.5 V[p-p]/75 Ω vertical timing pulse multiplexed	
Camera Output (1 - 16)	1.0 V[p-p]/75 Ω composite video signal	
Monitor Output (1 - 4)	1.0 V[p-p]/75 Ω composite video signal	
External Input	1.0 V[p-p]/75 Ω composite video signal	
External Output	1.0 V[p-p]/75 Ω composite video signal	
RS-485 (Camera) Port	RS-485 6-conductor modular jack	
Data Port	RS-485 6-conductor modular jack	
Alarm Port	25-pin D-sub connector	
Serial Port	9-pin D-sub connector	
Camera Switching Input	RCA pin jack	
Ambient Operating Temperature	-10°C ~ +50°C	
Ambient Operating Humidity	Less than 90 %	
Dimensions	420 mm (W) x 88 mm (H) x 350 mm (D) (without rubber foot)	
Weight (approx.)	6 kg	6.5 kg

System Controller; WV-CU360CJ

Power Source	9 V DC, 400 mA (Use the supplied AC adapter only.)
Power Consumption	10 W
Data Output/Input Port	6-conductor modular jack (RS-485, Full Duplex)
Monitor Number Selection	1-4
Camera Number Selection	1-16
Camera Main Control	Camera Setup Camera Function
Lens Functions	Iris: Open/Close/Preset (only with DC control lens) Focus: Near/Far/Auto Focus Zoom: Wide/Tele
Housing	Defroster: On/Off Wiper: On/Off Auxiliary 1: On/Off Auxiliary 2: On/Off
Pan/Tilt	Manual Pan: Right/Left, Manual Tilt: Up/Down, Auto Pan, Auto Sort, Auto Sequence, Preset Position, Home Position, Camera Patrol
System Operation	Camera selection, Alarm (Display/Suspend/Reset), Setup
Ambient Operating Temperature	-10°C ~ +50°C
Ambient Operating Humidity	Less than 90%
Dimensions	335 (W) x 145.5 (H) x 177 (D) mm
Weight (approx.)	1.4 kg

APPEARANCE

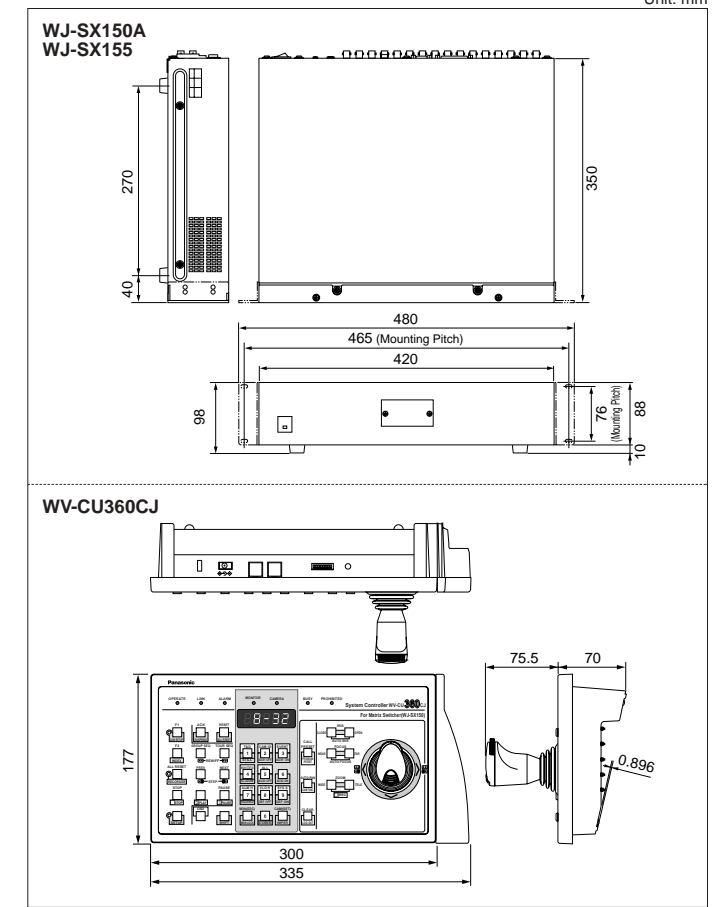

SYSTEM EXAMPLES

1 with optional Panasonic Digital Disk Recorder; WJ-HD500B

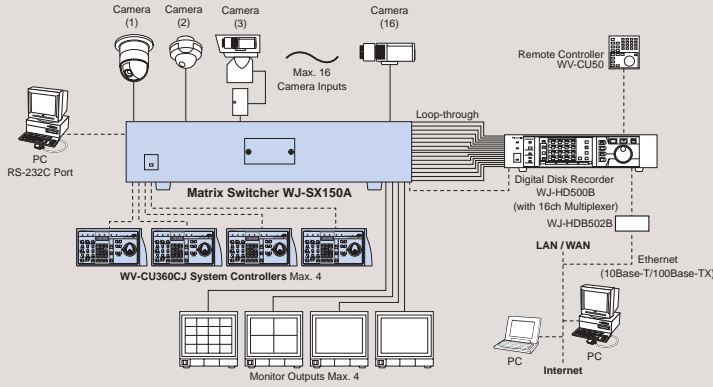

2 with optional Time-Lapse VTR or WJ-HD100

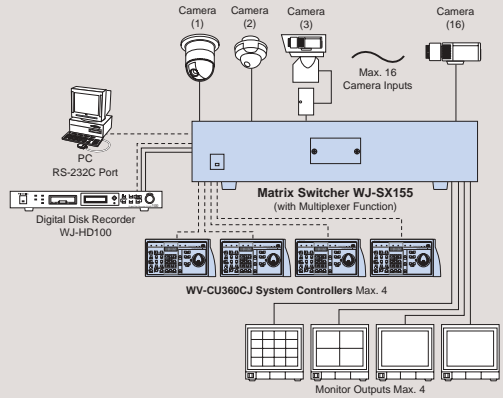

3 support up to 64 Camera Systems

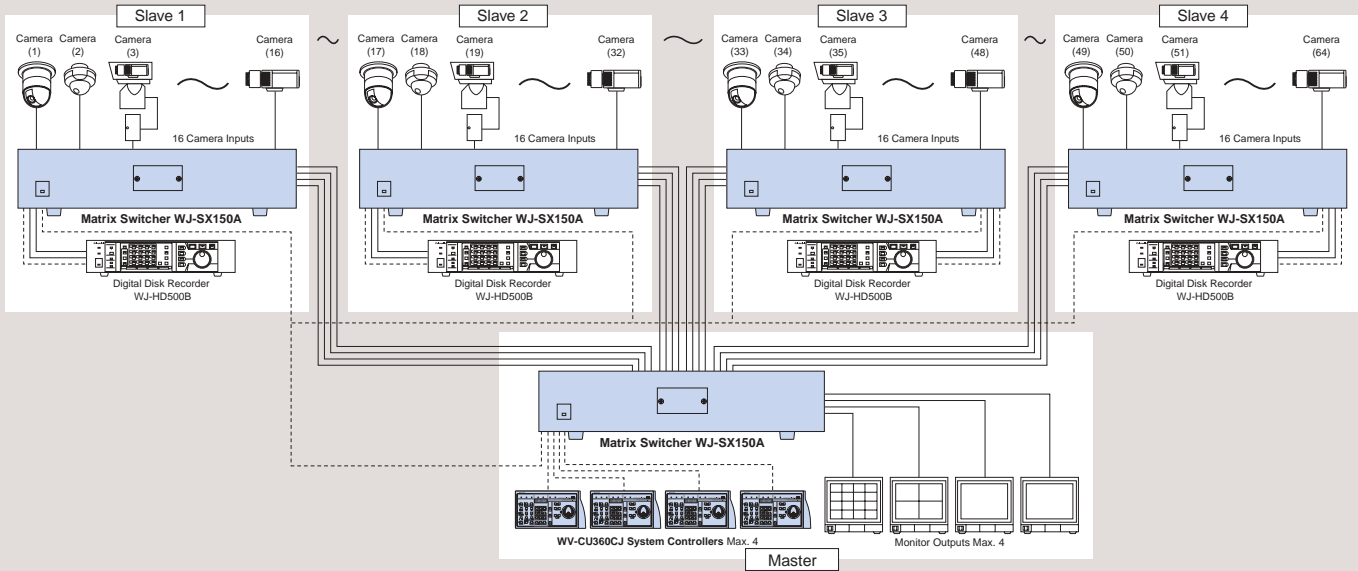

MATRIX SYSTEM150 PRODUCT COMPONENTS

Matrix Switcher
WJ-SX150A



Matrix Switcher with
Multiplexer Function
WJ-SX155



System Controller
WV-CU360CJ



OPTIONAL COMPONENTS

Digital Disk Recorder

Digital Disk Recorder
with 16ch Multiplexer
WJ-HD500B



Colour Surveillance Cameras

Super Dynamic II
Colour Dome Cameras
WV-CS850A Series
SDII



Weather Proof &
Vandal Resistant
Colour Dome Cameras
WV-CW860 Series



Vandal Proof
Super Dynamic II
Colour Camera
WV-CW474F
SDII



Super Dynamic II
1/3-type Colour Surveillance Cameras
WV-CP470 Series
SDII



Lens: optional

1/3-type DSP Colour CCD Cameras
WV-CP240 Series



Lens: optional

• All TV pictures are simulated. • Weights and dimensions are approximate. • Specifications are subject to change without notice. • These products may be subject to export control regulations.

DISTRIBUTED BY:

Panasonic System Solutions Company
Matsushita Electric Industrial Co., Ltd.
4-3-1, Tsunashima-higashi, Kohoku-ku, Yokohama,
223-8639, Japan
Tel 81(0)45-540-5769
Fax 81(0)45-540-5773
URL <http://panasonic.co.jp/pss/cctv/en/index.html>

Panasonic

Panasonic is the brandname of Matsushita Electric.
Printed in Japan WJ-KXS150AC (2N-694C)